

WHEEL ADJUSTMENT:

It should be noted that all three wheel vehicles can be easily influenced to deviate from a straight line. In most cases strollers can have a tendency to pull to the right/left due to many factors. Including uneven tire pressure, improper wheel installation, road conditions and manufacturing tolerances. If you find your Baby Trend stroller to significantly track or pull to the left or right while use on flat terrain, follow the sequence of the instructions on page 3 / page 5 to realign your Front Wheel.

FLAT TIRE:

The jogging stroller features bicycle tires to allow for extended wear and ease of pushing. Just like a bicycle tire, the jogging stroller can suffer from flat tires. If you have a flat tire, you can use a standard bicycle tire repair kit to repair the tire or you can take the tire to a bicycle shop for repair. If you experience numerous flat tires, you may want to purchase thorn proof inner tubes for the jogging stroller. These can be purchased at bicycle stores or at many national retail stores. The correct size to purchase is shown on the sidewall of the tire.



IF YOU EXPERIENCE ANY DIFFICULTY IN USING THIS PRODUCT, PLEASE CONTACT OUR CUSTOMER SERVICE DEPARTMENT AT 1-800-328-7363 BETWEEN THE HOURS OF 8:00 A.M. AND 4:30 P.M. PACIFIC STANDARD TIME FOR ASSISTANCE. PLEASE HAVE YOUR MODEL NUMBER AND MANUFACTURING DATE AVAILABLE WHEN YOU CALL. THIS INFORMATION CAN BE FOUND ON A SMALL STICKER ON THE INSIDE OF THE STROLLER FRAME.



Contact us by mail:
Baby Trend, Inc.
1607 S. Campus Ave., Ontario, CA 91761

Contact us by phone:
1-800-328-7363 (8:00am ~ 4:30pm PST)
or online <http://www.babytrend.com>

**Read all instructions BEFORE assembly and USE of product.
KEEP INSTRUCTIONS FOR FUTURE USE.**

Expedition ELX

Jogging Stroller

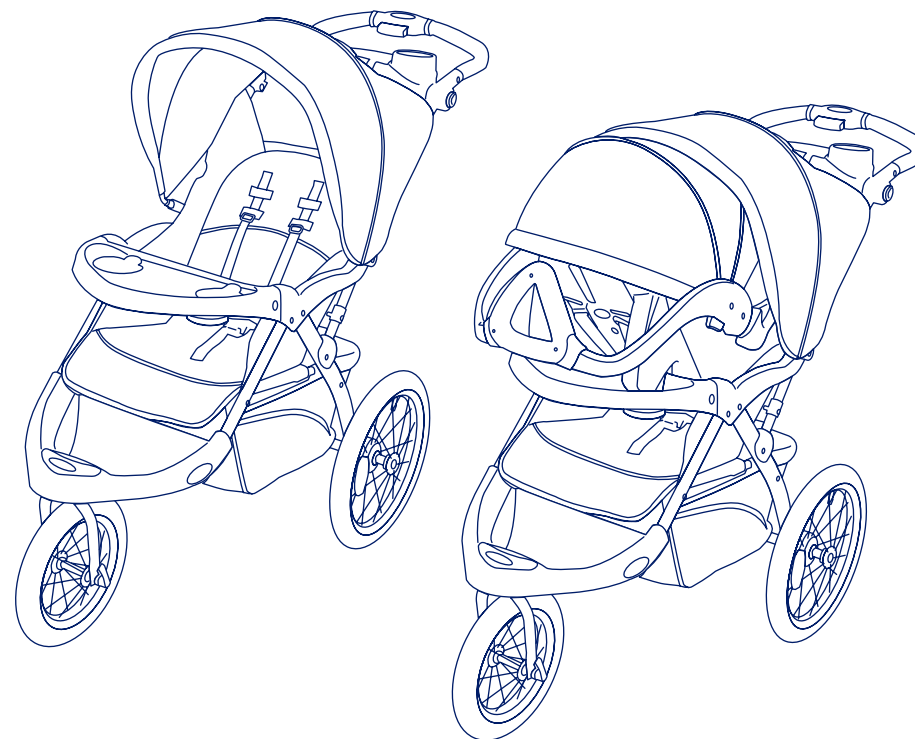

Instruction Manual



⚠ WARNING: Please follow all of these instructions to ensure the safety of your child. Keep these instructions for future reference.

⚠ WARNING: Failure to follow these instructions could result in serious injury or death. Avoid serious injury from falling or sliding out. Always use the safety harness and insure that the children are properly positioned according to these instructions.

⚠ WARNING: Never leave children unattended.

- **CAUTION:** This single jogger is designed for one child only. Use with more than one child may cause the unbalance condition which can injure/harm your child.
- Purses, shopping bags, parcels, diaper bags or accessory items may change the balance of the stroller and cause hazardous unstable conditions.
- The maximum weight that can be carried in the basket is 5 lb, Child Tray and Parent Tray are 3 lbs each. The maximum weight can be carried in the side pockets (2) is 3 lbs, back pockets (2) is 3 lbs and Canopy pockets is (2) 1 lb. Excessive weight may cause a hazardous unstable condition to exist.
- Be certain the stroller is fully erect and latched in the open position before allowing the children near the stroller.
- Use of the stroller with children weighing more than 40 pounds or over 42 inches tall, will cause excessive wear and stress on the stroller and may cause a hazardous unstable condition to exist.
- **NEVER** use the stroller on stairways or escalators.
- **NEVER** use the stroller with roller skates, in-line skates, skateboards or bicycles.
- We recommend that the child occupant be at least 6 months of age prior to use of the stroller for jogging. Because children develop at different rates, please discuss the use of a jogging stroller with your health care provider prior to jogging with your child.
- **NEVER** allow your stroller to be used as a toy.
- To clean use only mild household soap or detergent and warm water on a sponge or clean cloth.
- Check your stroller for loose screws, worn parts, torn material or stitching on a regular basis. Replace or repair parts as needed.
- Discontinue use of stroller should it malfunction or become damaged. Please contact our customer service Parts Hotline to arrange for repair or obtain replacement parts.

If you experience any difficulty with the use of our product or have a question regarding these instructions, please contact our Customer Service Department at 1-800-328-7363 between the hours of 8:00 a.m. and 4:30 p.m. (PST). Please do not return the product to the store as once it is returned it cannot be re-sold and the materials and energy used to make it are wasted.

Contact us by mail:
Baby Trend, Inc.
 1607 S. Campus Ave., Ontario, CA 91761

Contact us by phone:
 1-800-328-7363 (8:00am ~ 4:30pm PST)
 or online <http://www.babytrend.com>

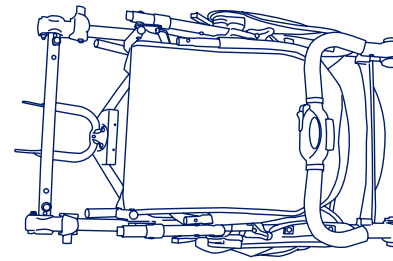

Stroller

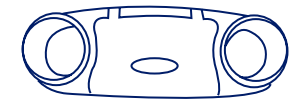

Parent Tray



Front Wheel

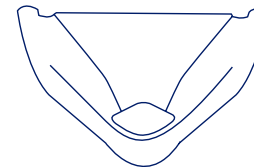

Fender

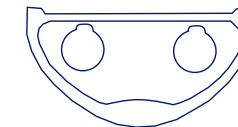

Child Tray (Type A)

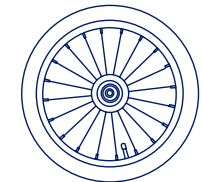

Rear Wheels



Fender Screws

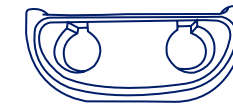

Child Tray (Type B)

OPTIONAL

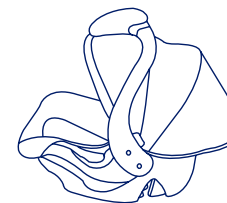

Infant Car Seat

Infant car seat comes with a stay in car base. Base types vary. Please refer to the manual located under the car seat for base type and instructions.



Tire Pump

IMPORTANT! To ensure safe operation of your stroller, please follow these instructions carefully. Please keep these instructions for future reference.

IMPORTANT! Before assembly and each use, inspect this product for damaged hardware, loose joints, missing parts or sharp edges. NEVER use if any parts are missing or broken.

IMPORTANT! Adult assembly is required.

Remove stroller from box. The Front Wheel, Rear Wheels, Fender, and Parent Tray need to be installed prior to use.

Unlock the release lever. (Fig. 1a) Unfold stroller frame by pulling backward on the stroller handle.

FRONT WHEEL

To attach the Front Wheel, unfold stroller as described in the section following:

- Lean the stroller backwards so that it rests on the handle and rear axle frame and the Front Wheel forks are pointing upward. (Fig. 1b)
- The Front Wheel features a quick release attachment system. The quick release must be open enough for the wheel to slide on the forks. Rotate the lever forward to loosen one side (Fig. 2a) and loosen the finger nut on the other side. (Fig. 2b)
- Slide the front wheel onto the front forks. (Fig. 3a) Make sure the front forks are in the position as shown on Fig. 3b.
- Line up the tab on the Retainer Plate with the Slot on both sides of the forks. (Fig. 3c) **IMPORTANT!** The tab on the Retainer Plate must be lined up with the slot before tightening the wheel.
- With the wheel in position, tighten the finger nut on the axle until it is very close to contacting the fork and rotate the lever to tighten it as shown in Fig. 4.
- Close the lever (Fig. 5) and you should feel significant resistance and the wheel should be held tightly. If you do not, open the lever and tighten the finger nut a bit more and close the lever again. Continue to do this until the wheel

is held tightly in the fork.
DO NOT OVER TIGHTEN.

WARNING: Always make sure the lever is in closed position before use. Leaving the lever in opened position can cause the wheel to fall off.

- If you experience Front Wheel wobble that is beyond what is normal for use while walking or jogging you may have to adjust the Front Wheel housing nut. This nut is located under the footrest located at the front of the jogger. You can use a standard crescent wrench to tighten the nut. **DO NOT OVER TIGHTEN** this can cause damage to the wheel housing. (Fig. 6)

FENDER

To secure the Fender to the frame, use the 4 screws provided.

- Examine the bottom of the front Fender. You will notice four 1/4 inch diameter plastic tubes protruding from the bottom (Fig. 7a).
- These tubes must be lined up with the holes in the front frame assembly (Fig. 7b).
- Line up the front Fender and press onto the front frame assembly (Fig. 7c).
- Insert the 4 screws through the underside of the front frame assembly into the front Fender's plastic tubes. Tighten the screws only until snug (Fig. 7d). **DO NOT OVER TIGHTEN.**

REAR WHEEL

Lean the stroller forward to rest on the Front Wheel. To attach the Rear Wheels, push each wheel's axle into the plastic corner fitting as shown in Fig. 8. Depress the metal lever on the inside of the corner fitting as you push the axle into corner fitting. When the wheel will not go on any farther, release the lever. Check that the wheel has locked into the corner fitting by pulling on the lever, push the wheel on farther and release lever.

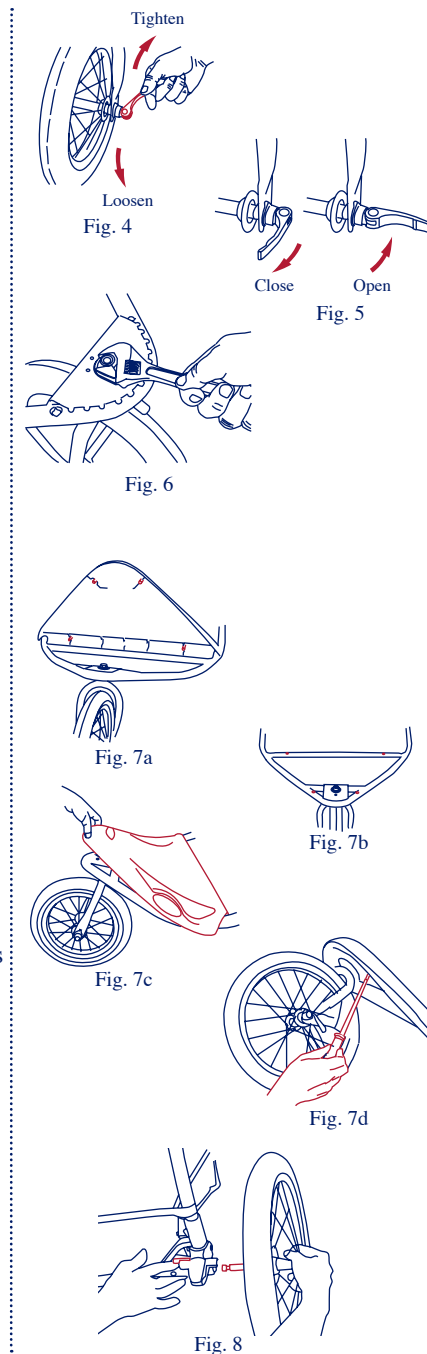
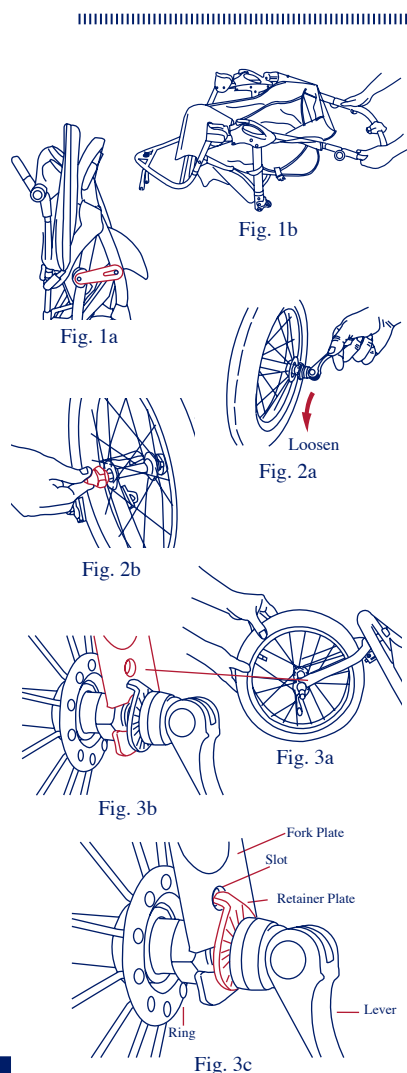



Fig. 9

Ensure that the wheels are firmly locked into place. **NEVER** use the stroller if the wheels are not locked into place, contact our customer service department immediately at 1-800-328-7363, between the hours of 8:00am and 4:30pm PST, for assistance.

PARENT TRAY

To attach Parent Tray, line up the Parent Tray slots with corresponding slots on the stroller frame and slide down until locking into place. (Fig. 9) Check to make sure the Parent Tray is secure before using.

⚠ WARNING: Do not place hot liquids or more than 3 pounds in the Parent Tray. Serious burns or unstable conditions could result.

CANOPY

To install the canopy, slide the male ends of the canopy into the female slots on the stroller frame (Fig. 10a)

To open the canopy: push forward on the front edge of the canopy while holding the rear of canopy in place. (Fig. 10b) **To fold the canopy:** pull backwards on the front edge. (Fig. 10b)

CHILD TRAY (if equipped)

To attach the front Child Tray: Insert the tray clip into the fitting on the stroller's fold joint. Check the tray clip locks into place. (Fig. 11a) Push the angled tray onto the post at the end of the right armrest, while pressing downward on the snap button, until locked into place. Rotate the tray downward until latched onto the left armrest. Please check that the snap button comes through and securely latches the tray in place. (Fig. 11b)

To open the front Child Tray: press inward on left side tray release button and rotate upward on the tray. Please see figure 11c. Please note that you may remove the tray completely by depressing the buttons on each side while pulling forward on the tray. (Fig. 11d)

BASKET

Rear basket tube needs to be installed prior to use. Insert the female end of the rear basket tube into the male ends located on the basket frame until it locks into place. (Fig. 12)

INFANT CAR SEAT (if equipped)

Please refer to the Infant Car Seat instruction manual for more details.

To attach the Baby Trend Infant Car Seat, recline the seat all the way back.

- Position the Infant Car Seat, facing toward the rear of the jogger, so that the seat shell goes into the Child Tray and latches into place. (Fig. 13a) Check that the Infant Car Seat is firmly locked onto the Child Tray before using.
- Check that the front Child Tray is firmly attached to the jogger's armrests. Make sure that the car seat locks into the front Child Tray. Then turn tabs on stroller frame to lock the front of the car seat into the stroller. (Fig. 13b)
- To remove the Infant Car Seat, squeeze the release handle located at the foot-end of the seat and carefully lift upward on the seat. (Fig. 14)

IMPORTANT! When a Car Seat is not attached to the Jogger Car Seat Tabs should be rotated away from the Child until they are locked in place.

MP3 SPEAKER (if equipped)

The Canopy comes with a speaker sewn into a MP3 storage pocket on the side of the Canopy. The speaker has a wire with a male jack for use with MP3 player so you and your child can listen to music while you jog. Connect male end of speaker wire into your MP3 player. (Fig. 15)

Your stroller is now ready to use.

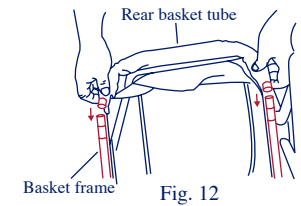

Fig. 12

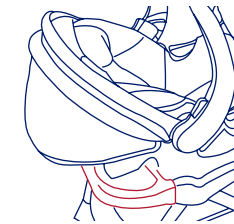

Fig. 13a

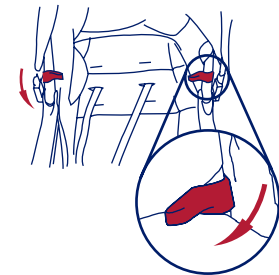

Fig. 13b



Fig. 14

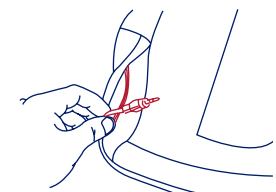

Fig. 15

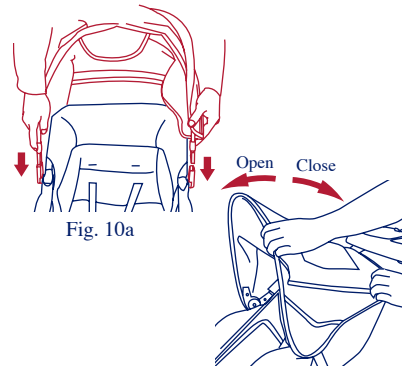

Fig. 10a

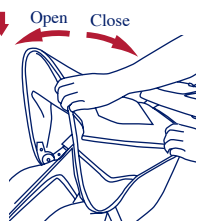

Fig. 10b

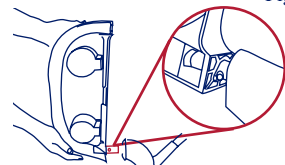

Fig. 11a



Fig. 11b

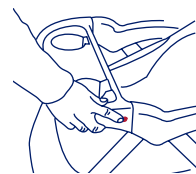

Fig. 11c

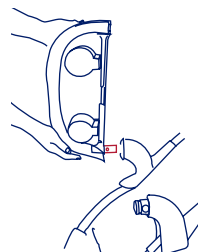

Fig. 11d

Before placing your children in the stroller, please follow the instructions below.

⚠️ WARNING: Always check with your pediatrician for a recommended starting age / weight for your baby in an all terrain stroller.

⚠️ WARNING: Always set brakes when the stroller is not being pushed so that the stroller will not roll away. **NEVER** leave stroller unattended on a hill or incline as the stroller may slide down the hill.

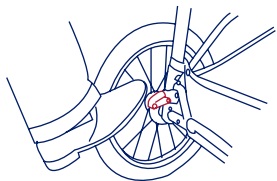

Fig. 16

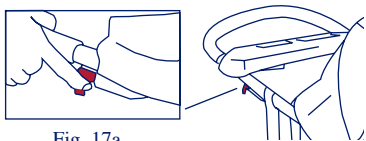

Fig. 17a

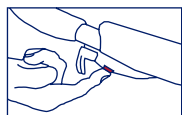

Fig. 17b

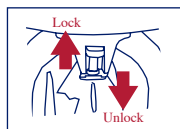

Fig. 17c

BRAKES

To engage brakes, apply light downward pressure to the brake lever located on each Rear Wheel. The stroller may require slight forward or rearward movement in order to line up the teeth on the brake with each wheel brake cluster. (Fig. 16) Check that the stroller will not move and that both brakes are properly applied. To release, gently lift up on the brake lever.

⚠️ WARNING: Always lock the front swivel wheel in **STRAIGHT** position before placing or removing your children from the jogger.

The swivel jogger comes equipped with a Front Wheel locking device. Fig. 17a is a remote release lever located under the right side handle. Pull the Remote Release Lever to disengage the wheel and Front Wheel should begin to swivel. To Lock Swivel Wheel, press black button (Fig. 17b) on underside of Remote Release Lever and push forward on the Jogger until you hear the wheel click into place. Test that wheel is now secure by attempting to turn Jogger. Fig. 17c Front Wheel lock works in a vertical motion from top to bottom, locking and unlocking the wheel.

⚠️ WARNING: Avoid serious injury from falling or sliding out. Always use the safety harness.

⚠️ STRANGULATION HAZARD: Child can strangle in loose straps. Never leave child in seat when straps are loose or undone.

TO SECURE THE CHILD

The shoulder straps of the 5-point harness have 2 attachment positions. Select the position that places the shoulder strap level with, or below the top of the child's shoulder.

- Carefully place the child in the stroller seat and bring the safety harness around the child's waist and over the shoulders. Place the crotch strap between the child's legs. Insert the male end of each shoulder/waist belt into the buckle on the crotch strap. Tighten the harness to be snug around the child's waist and over the child's shoulders. Please see figure 18a.

- To release, apply pressure to both sides of each male clip until the clip is released. See figure 18b. This process requires a moderate amount of effort so as to prevent an accidental release by your child.

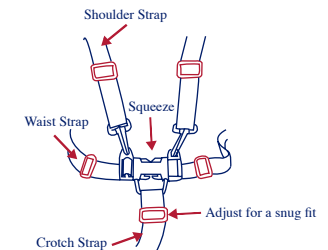

Fig. 18a

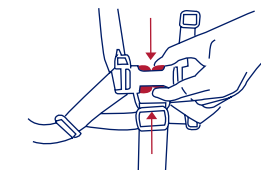

Fig. 18b

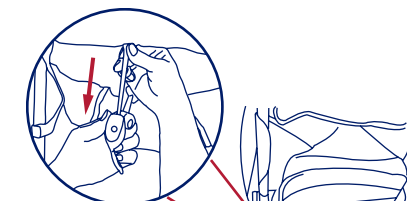

Fig. 19

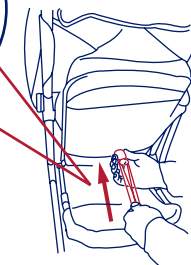

Fig. 20

SEATBACK POSITIONING

The seat has a multiple position recline that is controlled by a strap and buckle assembly behind the seat. (Fig. 19) To recline the seat, loosen the strap through the buckle and adjust to the required recline position. (Fig. 20) To place the seat back in a more upright position, press upward on the seat back with one hand while pulling the strap through the buckle with the other. The strap will lock automatically.

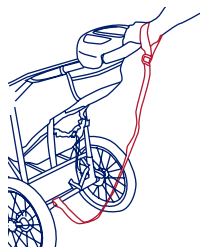

Fig. 21

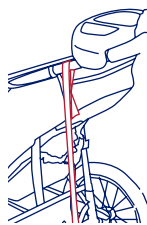

Fig. 22

Flexible air hose inside
Fig. 23aRemove flexible air hose
Fig. 23bValve stem of rim Small brass fitting
Fig. 23c

Fig. 23d

The upright position should be used **only for a child that is at least 6 months old**. Always re-adjust the safety harness, including the shoulder belts, when repositioning the seatback.

JOGGING WITH YOUR STROLLER

When you are jogging with your child, use the following safety features:

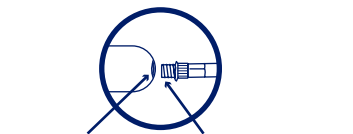
- **LOCK THE FRONT SWIVEL WHEEL IN STRAIGHT POSITION**
- **SAFETY WRIST STRAP:** Always connect the safety strap to either wrist when jogging. This strap will keep the stroller from rolling away in the event that you trip while running. (Fig. 21) The safety strap must remain connected to the rear lower frame cross member at all times. This location is intended to prevent the stroller being tipped backward in the event that you do fall to the ground. The safety strap includes a Velcro attachment for storage, on the left side of the stroller, when not in use. (Fig. 22)

TIRES

Tires are shipped un-inflated. The tires should be inflated on a regular basis to between 20 to 25 pounds of air pressure. Always use a bicycle style hand air pump to inflate the tires.

Remove Tire Pump (**if equipped**) from storage location, remove flexible air hose (Fig. 23a) from end of pump (Fig. 23b), thread small brass fitting into opposite end of pump (Fig. 23c), thread air nozzle tip onto valve stem of rim (Fig. 23d), now you're ready to pump up your tires.

Hold the body of Tire Pump and pull back on the handle, press down on handle pushing air into tire. Repeat until tire is at 20 to 25 pounds.

CAUTION: Read the following section completely before folding your stroller!

WARNING: Care must be taken when folding and unfolding the stroller to prevent finger entrapment.

TO FOLD STROLLER

Close the Canopy as described in the Canopy section. Recline seat by releasing buckle as described in seatback positioning section.

Flip the carseat support tabs to the outside of the stroller frame before folding. To fold the stroller slide the ① RED fold lock with your thumb while squeezing the large ② RED fold button in the center of the handle and push forward on the handle. (Fig. 24)

Once the stroller begins to fold, release the red handle and push forward on the handle until the stroller is folded. Lock the red release lever to secure the stroller. (Fig. 25)

TO UNFOLD STROLLER

Unlock the release lever. (Fig. 25)

Unfold stroller frame by pulling backward on the stroller handle. (Fig. 26)

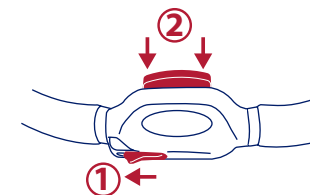

Fig. 24

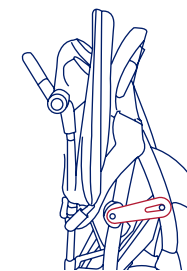

Fig. 25

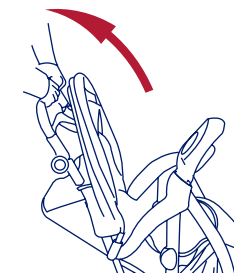

Fig. 26