

## TYPE 2: SWIVEL FRONT WHEEL

### WHEEL ADJUSTMENT:

It should be noted that all three wheel vehicles can be easily influenced to deviate from a straight line. In most cases strollers can have a tendency to pull to the right/left due to many factors. Including uneven tire pressure, improper wheel installation, road conditions and manufacturing tolerances. If you find your Baby Trend stroller to significantly track or pull to the left or right while use on flat terrain, follow the sequence of the instructions on page 3 / page 5 to realign your front wheel.

### FLAT TIRE:

The jogging stroller features bicycle tires to allow for extended wear and ease of pushing. Just like a bicycle tire, the jogging stroller can suffer from flat tires. If you have a flat tire, you can use a standard bicycle tire repair kit to repair the tire or you can take the tire to a bicycle shop for repair. If you experience numerous flat tires, you may want to purchase thorn proof inner tubes for the jogging stroller. These can be purchased at bicycle stores or at many national retail stores. The correct size to purchase is shown on the sidewall of the tire.



**IF YOU EXPERIENCE ANY DIFFICULTY IN USING THIS PRODUCT, PLEASE CONTACT OUR CUSTOMER SERVICE DEPARTMENT AT 1-800-328-7363 BETWEEN THE HOURS OF 8:00 A.M. AND 4:30 P.M. PACIFIC STANDARD TIME FOR ASSISTANCE. PLEASE HAVE YOUR MODEL NUMBER AND MANUFACTURING DATE AVAILABLE WHEN YOU CALL. THIS INFORMATION CAN BE FOUND ON A SMALL STICKER ON THE INSIDE OF THE STROLLER FRAME.**



Contact us by mail:  
Baby Trend, Inc.  
1607 S. Campus Ave., Ontario, CA 91761

Contact us by phone:  
1-800-328-7363 (8:00am ~ 4:30pm PST)  
or online <http://www.babytrend.com>

**Read all instructions BEFORE assembly and USE of product.  
KEEP INSTRUCTIONS FOR FUTURE USE.**

# Expedition LX

## Jogging Stroller

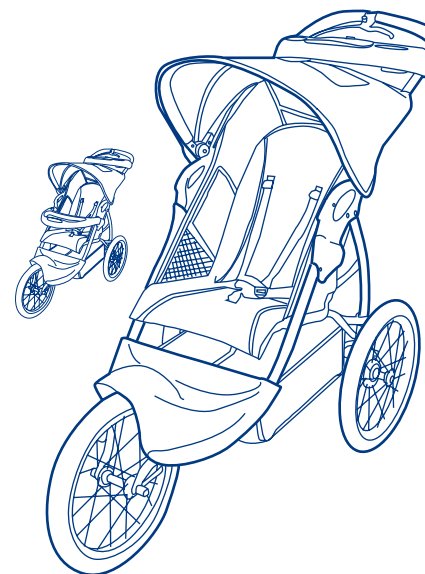

Type 1: Fixed front wheel

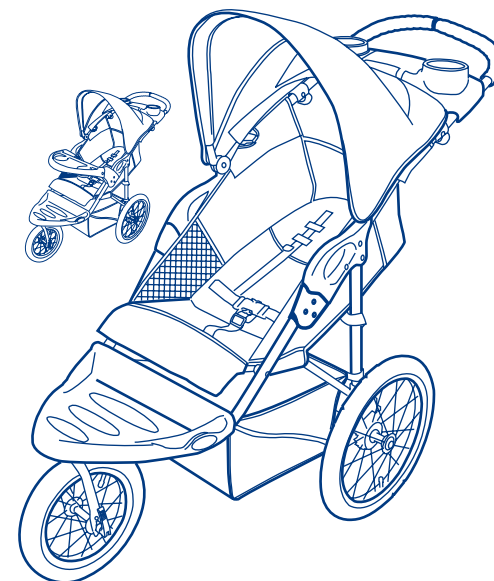

Type 2: Lockable swivel front wheel

## Instruction Manual



**⚠️ WARNING:** Please follow all of these instructions to ensure the safety of your child. Keep these instructions for future reference.

**⚠️ WARNING:** Failure to follow these instructions could result in serious injury or death. Avoid serious injury from falling or sliding out. Always use the safety harness and insure that the children are properly positioned according to these instructions.

**⚠️ WARNING:** Never leave children unattended.

- **CAUTION:** This single jogger is designed for one child only. Use with more than one child may cause the unbalance condition which can injure/ harm your child.
- Purses, shopping bags, parcels, diaper bags or accessory items may change the balance of the stroller and cause hazardous unstable conditions.
- The maximum weight that can be carried in the basket is 5 lb, child tray and parent tray are 3 lbs each. The maximum weight can be carried in the side pockets (2) is 3 lbs, back pockets (2) is 3 lbs and canopy pockets is (2) 1 lb. Excessive weight may cause a hazardous unstable condition to exist.
- Be certain the stroller is fully erect and latched in the open position before allowing the children near the stroller.
- Use of the stroller with children weighing more than 50 pounds or over 42 inches tall, will cause excessive wear and stress on the stroller and may cause a hazardous unstable condition to exist.
- **NEVER** use the stroller on stairways or escalators.
- **NEVER** use the stroller with roller skates, in-line skates, skateboards or bicycles.
- We recommend that the child occupant be at least 6 months of age prior to use of the stroller for jogging. Because children develop at different rates, please discuss the use of a jogging stroller with your health care provider prior to jogging with your child.
- **NEVER** allow your stroller to be used as a toy.
- To clean use only mild household soap or detergent and warm water on a sponge or clean cloth.
- Check your stroller for loose screws, worn parts, torn material or stitching on a regular basis. Replace or repair parts as needed.
- Discontinue use of stroller should it malfunction or become damaged. Please contact our customer service Parts Hotline to arrange for repair or obtain replacement parts.

*If you experience any difficulty with the use of our product or have a question regarding these instructions, please contact our Customer Service Department at 1-800-328-7363 between the hours of 8:00 a.m. and 4:30 p.m. (PST). Please do not return the product to the store as once it is returned it cannot be re-sold and the materials and energy used to make it are wasted.*

Contact us by mail:  
**Baby Trend, Inc.**  
 1607 S. Campus Ave., Ontario, CA 91761

Contact us by phone:  
**1-800-328-7363** (8:00am ~ 4:30pm PST)  
 or online <http://www.babytrend.com>

## TYPE 1: FIXED FRONT WHEEL

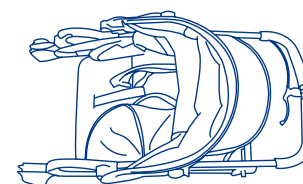

Stroller



Fender Screws

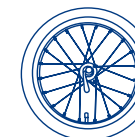

Front Wheel

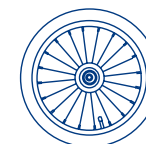
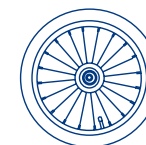

Rear Wheels



Parent Tray

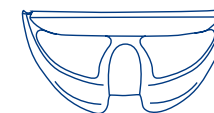

Fender

## TYPE 2: SWIVEL FRONT WHEEL

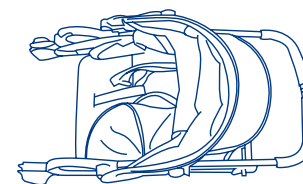

Stroller



Fender Screws



Front Wheel

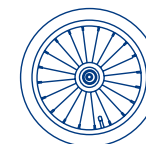
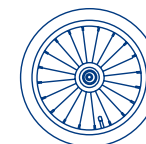

Rear Wheels



Parent Tray

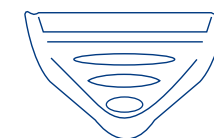

Fender

## OPTIONAL

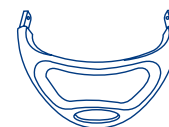

Child Tray (Type A)



Child Tray (Type B)



Pedometer

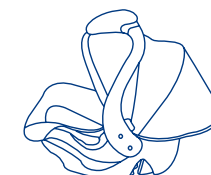

Infant Car Seat

Type 1

Type 2

**IMPORTANT!** To ensure safe operation of your stroller, please follow these instructions carefully. Please keep these instructions for future reference.

**IMPORTANT!** Before assembly and each use, inspect this product for damaged hardware, loose joints, missing parts or sharp edges. NEVER use if any parts are missing or broken.

**IMPORTANT!** Adult assembly is required.

Skip to page 5 if you have Type 2 Swivel Front Wheel

## Type 1: Fixed Front Wheel

Remove stroller from box. The front wheel, rear wheels, fender, and parent tray need to be installed prior to use.

### FRONT WHEEL

To attach the front wheel, unfold stroller as described in the section following:

- Lean the stroller backwards so that it rests on the handle and rear axle frame and the front wheel forks are pointing upward. (Fig. 1)
- The brake release lever must be in the open position. (Fig. 6)
- The front wheel features a quick release attachment system. The quick release must be open enough for the wheel to slide on the forks. Rotate the lever forward to loosen one side (Fig. 2a) and loosen the finger nut on the other side. (Fig. 2b)
- Slide the front wheel onto the front forks. (Fig. 3a) Make sure the front forks are in the position as shown on Fig. 3b.
- Line up the tab on the Retainer Plate with the Slot on both sides of the forks. (Fig. 3c)



Fig. 1

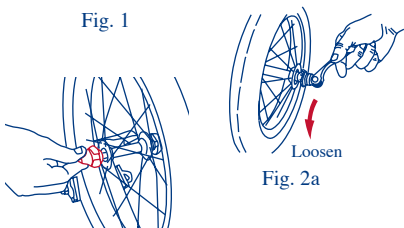

Loosen  
Fig. 2a

Fig. 2b

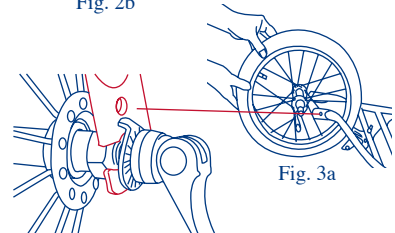

Fig. 3a

Fig. 3b

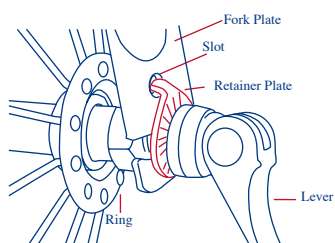
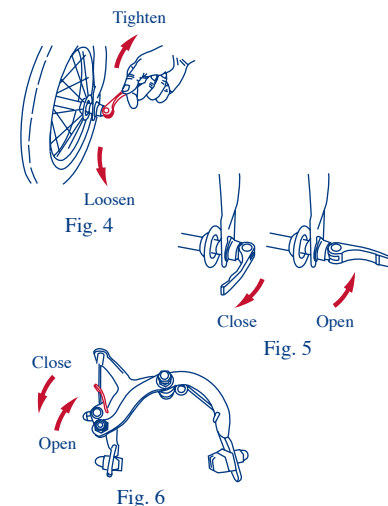

Fig. 3c

**IMPORTANT!** The tab on the Retainer Plate must be lined up with the slot before tightening the wheel.

- With the wheel in position, tighten the finger nut on the axle until it is very close to contacting the fork and rotate the lever to tighten it as shown in Fig. 4.
- Close the lever (Fig. 5) and you should feel significant resistance and the wheel should be held tightly. If you do not, open the lever and tighten the finger nut a bit more and close the lever again. Continue to do this until the wheel is held tightly in the fork. **DO NOT OVER-TIGHTEN.**



Loosen  
Fig. 4

Close Open  
Fig. 5

Close Open  
Fig. 6

**⚠ WARNING:** Always make sure the lever is in closed position before use. Leaving the lever in opened position can cause the wheel to fall off.

- Close the brake release lever by rotating it toward the front of the stroller. (Fig. 6).

### FENDER

To secure the fender to the frame, use the 4 screws provided.

- Examine the bottom of the front fender. You will notice four 1/4 inch diameter plastic tubes protruding from the bottom (Fig. 7a).
- These tubes must be lined up with the holes in the front frame assembly (Fig. 7b).
- Line up the front fender and press onto the front frame assembly (Fig. 7c).
- Insert the 4 screws through the underside of the front frame assembly into the front fender's plastic tubes. Tighten the screws only until snug (Fig. 7d). **NO NOT OVER-TIGHTEN.**

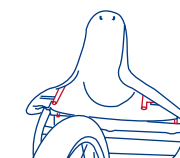

Fig. 7a

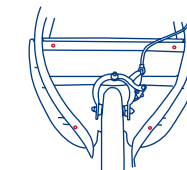

Fig. 7b

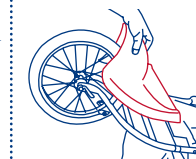

Fig. 7c

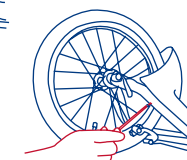

Fig. 7d

**IMPORTANT!** To ensure safe operation of your stroller, please follow these instructions carefully. Please keep these instructions for future reference.

**IMPORTANT!** Before assembly and each use, inspect this product for damaged hardware, loose joints, missing parts or sharp edges. NEVER use if any parts are missing or broken.

**IMPORTANT!** Adult assembly is required.

## Type 2: Swivel Front Wheel

Remove stroller from box. The front wheel, rear wheels, fender, and parent tray need to be installed prior to use.

### FRONT WHEEL

To attach the front wheel, unfold stroller as described in the section following:

- Lean the stroller backwards so that it rests on the handle and rear axle frame and the front wheel forks are pointing upward. (Fig. 1)
- The front wheel features a quick release attachment system. The quick release must be open enough for the wheel to slide on the forks. Rotate the lever forward to loosen one side (Fig. 2a) and loosen the finger nut on the other side. (Fig. 2b)
- Slide the front wheel onto the front forks. (Fig. 3a) Make sure the front forks are in the position as shown on Fig. 3b.
- Line up the tab on the Retainer Plate with the Slot on both sides of the forks. (Fig. 3c)  
**IMPORTANT!** The tab on the Retainer Plate must be lined up with the slot before tightening the wheel.
- With the wheel in position, tighten the finger nut on the axle until it is very close to contacting the fork and rotate the lever to tighten it as shown in Fig. 4.

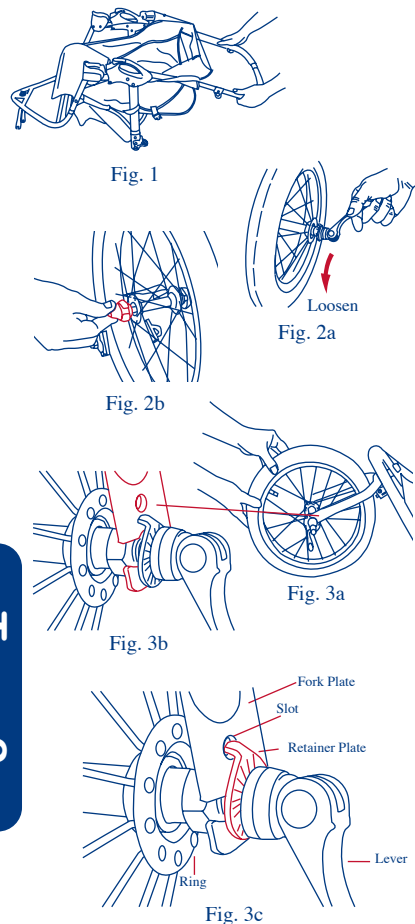

- Close the lever (Fig. 5) and you should feel significant resistance and the wheel should be held tightly. If you do not, open the lever and tighten the finger nut a bit more and close the lever again. Continue to do this until the wheel is held tightly in the fork.  
**DO NOT OVER TIGHTEN.**

**⚠ WARNING:** Always make sure the lever is in closed position before use. Leaving the lever in opened position can cause the wheel to fall off.

- If you experience front wheel wobble that is beyond what is normal for use while walking or jogging you may have to adjust the front wheel housing nut. This nut is located under the footrest located at the front of the jogger. You can use a standard crescent wrench to tighten the nut.  
**DO NOT OVER TIGHTEN** this can cause damage to the wheel housing. (Fig. 6)

### FENDER

To secure the fender to the frame, use the 4 screws provided.

- Examine the bottom of the front fender. You will notice four 1/4 inch diameter plastic tubes protruding from the bottom (Fig. 7a).
- These tubes must be lined up with the holes in the front frame assembly (Fig. 7b).
- Line up the front fender and press onto the front frame assembly (Fig. 7c).
- Insert the 4 screws through the underside of the front frame assembly into the front fender's plastic tubes. Tighten the screws only until snug (Fig. 7d). **DO NOT OVER TIGHTEN.**

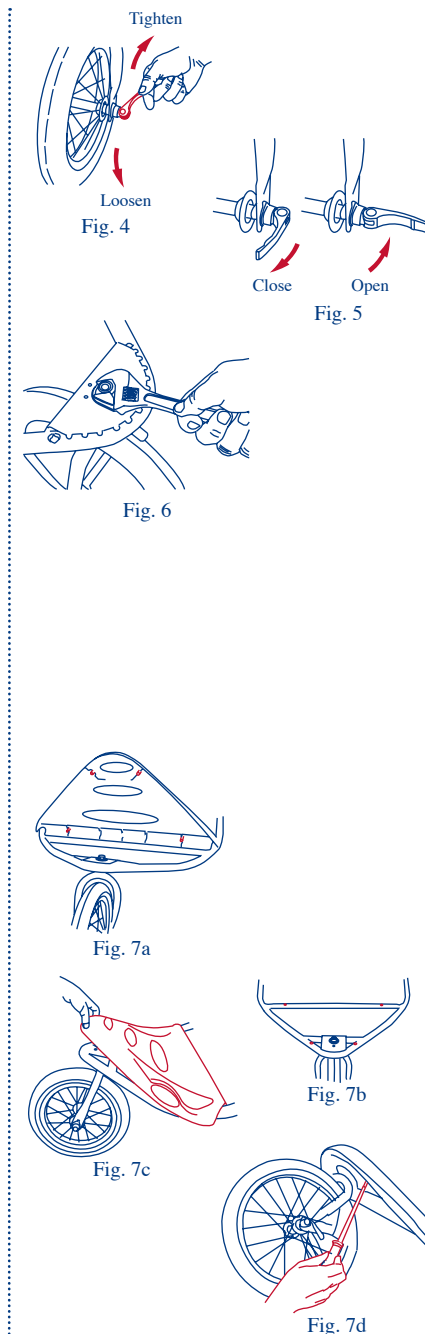

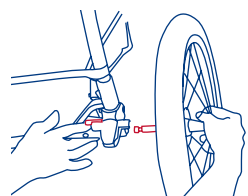

Fig. 8

## REAR WHEEL

Lean the stroller forward to rest on the front wheel. To attach the rear wheels, push each wheel's axle into the plastic corner fitting as shown in Fig. 8. Depress the metal lever on the inside of the corner fitting as you push the axle into corner fitting. When the wheel will not go on any farther, release the lever. Check that the wheel has locked into the corner fitting by pulling on the wheel. If not locked, lift upward on the lever, push the wheel on farther and release lever.

Ensure that the wheels are firmly locked into place. **NEVER** use the stroller if the wheels are not locked into place, contact our customer service department immediately at 1-800-328-7363, between the hours of 8:00am and 4:30pm PST, for assistance.

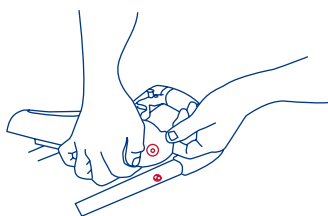

Fig. 9

## PARENT TRAY

To attach the parent tray, align the fittings on the ends of the parent tray with the fittings on the outsides of the handle. Hook the hole in the parent tray. Pull outward on the opposite end while pushing down on the tray until locked onto the stroller handle. Please be careful not to pinch your fingers when installing the parent tray. (Fig. 9) To remove the parent tray, pull outward on one end of the tray while lifting upward.

**⚠️ WARNING:** Do not place hot liquids or more than 3 pounds in the parent tray. Serious burns or unstable conditions could result.

## CANOPY

**To open the canopy:** push forward on the front edge of the canopy while holding the rear of canopy in place. (Fig. 10a)

**To fold the canopy:** pull backwards on the front edge. (Fig. 10b)



Fig. 10a

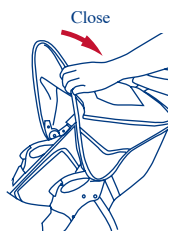

Fig. 10b

## CHILD TRAY (if equipped)

### TYPE A:

**To attach the front child tray:** line up male fittings of the child tray with the female fitting on the outside of the center joint and push inward (toward the rear of the stroller) until locked in place. (Fig. 11a)

**To remove the front child tray:** depress the button on the underside of the male fitting and pull the tray outward to remove. (Fig. 11b)

### TYPE B:

**To attach the front child tray:** Insert the tray clip into the fitting on the stroller's fold joint. Check the tray clip locks into place. (Fig. 11c) Push the angled tray onto the post at the end of the right armrest, while pressing downward on the snap button, until locked into place. Rotate the tray downward until latched onto the left armrest. Please check that the snap button comes through and securely latches the tray in place. (Fig. 11d)

**To open the front child tray:** press inward on left side tray release button and rotate upward on the tray. Please see figure 11e. Please note that you may remove the tray completely by depressing the buttons on each side while pulling forward on the tray.

## INFANT CAR SEAT (if equipped)

Please refer to the infant car seat instruction manual for more details.

## PEDOMETER (if equipped)

The pedometer is located in a separate box inside the main box. Slide the pedometer onto the provided mounting bracket as shown in Fig. 12. Instructions on how to use the pedometer are included in the separate box. Caution: When folding the stroller, please make sure to rotate the pedometer inside towards the parent tray to prevent damage when folded.

## MP3 SPEAKER (if equipped)

The canopy comes with a speaker sewn into a mp3 storage pocket on the side of the canopy. The speaker has a wire with a male jack for use with mp3 player so you and your child can listen to music while you jog. Connect male end of speaker wire into your mp3 player. (Fig. 13)

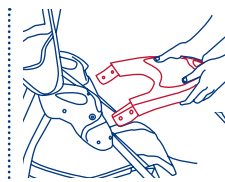

Fig. 11a

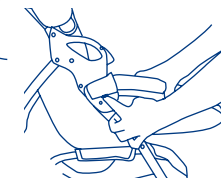

Fig. 11b

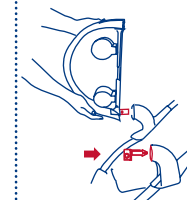

Fig. 11c

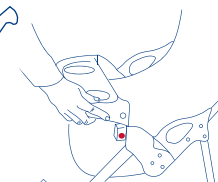

Fig. 11d

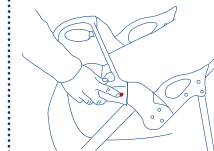

Fig. 11e

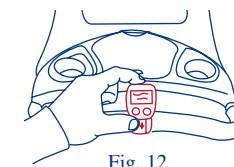

Fig. 12

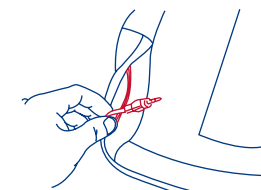

Fig. 13

**Your stroller is now ready to use.**

Type 1 & 2

Type 2

7

8

Before placing your children in the stroller, please follow the instructions below.

**⚠️ WARNING:** Always check with your pediatrician for a recommended starting age / weight for your baby in an all terrain stroller.

**⚠️ WARNING:** Always set brakes when the stroller is not being pushed so that the stroller will not roll away. NEVER leave stroller unattended on a hill or incline as the stroller may slide down the hill.

### BRAKES

To engage brakes, apply light downward pressure to the brake lever located on each rear wheel. The stroller may require slight forward or rearward movement in order to line up the teeth on the brake with each wheel brake cluster. (Fig. 14) Check that the stroller will not move and that both brakes are properly applied. To release, gently lift up on the brake lever.

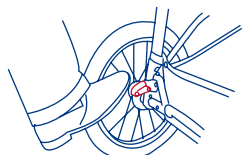

Fig. 14

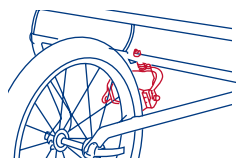

Fig. 15

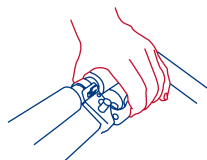

Fig. 16

Type 1 only

Your stroller may come equipped with a caliper brake system. (Fig. 15) The front wheel bicycle style caliper brake system that is designed to assist you in slowing the stroller on a hill or in the event of an emergency. Squeeze the brake handle to slow the stroller. (Fig. 16) The hand brake is not to be used as a parking brake.

**⚠️ WARNING:** Always lock the front swivel wheel in STRAIGHT position before placing or removing your children from the jogger.

The type 2 swivel jogger come equipped with a front wheel locking device. Fig. 17a is a remote release lever located under the right side handle. Pull to disengage the wheel and push to engage

the locking device located under the footrest. Fig. 17b front wheel lock works in a horizontal motion from left to right, locking and unlocking the wheel. Fig. 17c front wheel lock works in a vertical motion from top to bottom, locking and unlocking the wheel.

**⚠️ WARNING:** Avoid serious injury from falling or sliding out. Always use the safety harness.

**⚠️ STRANGULATION HAZARD:** Child can strangle in loose straps. Never leave child in seat when straps are loose or undone.

### TO SECURE THE CHILD

The shoulder straps of the 5-point harness have 2 attachment positions. Select the position that places the shoulder strap level with, or below the top of the child's shoulder.

- Carefully place the child in the stroller seat and bring the safety harness around the child's waist and over the shoulders. Place the crotch strap between the child's legs. Insert the male end of each shoulder/waist belt into the buckle on the crotch strap. Tighten the harness to be snug around the child's waist and over the child's shoulders. Please see figure 18a.

- To release, apply pressure to both sides of each male clip until the clip is released. See figure 18b. This process requires a moderate amount of effort so as to prevent an accidental release by your child.

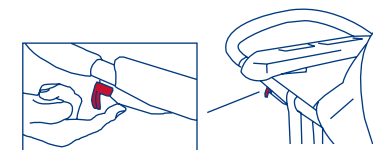

Fig. 17a

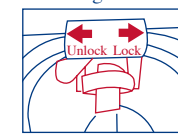

Fig. 17b

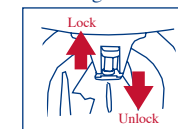

Fig. 17c

Type 2 only

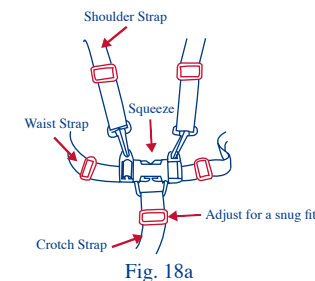

Fig. 18a

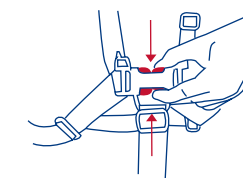
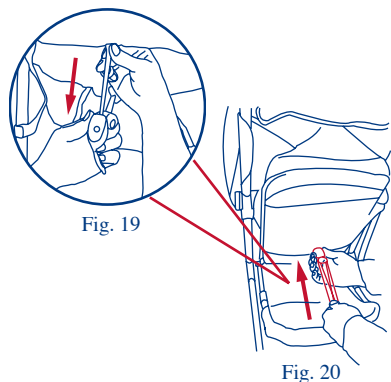

Fig. 18b



### SEATBACK POSITIONING

The seat has a multiple position recline that is controlled by a strap and buckle assembly behind the seat. (Fig. 19) To recline the seat, loosen the strap through the buckle and adjust to the required recline position. (Fig. 20) To place the seat back in a more upright position, press upward on the seat back with one hand while pulling the strap through the buckle with the other. The strap will lock automatically.

The upright position should be used **only for a child that is at least 6 months old**. Always re-adjust the safety harness, including the shoulder belts, when repositioning the seatback.

### JOGGING WITH YOUR STROLLER

When you are jogging with your child, use the following safety features:

- **LOCK THE FRONT SWIVEL WHEEL IN STRAIGHT POSITION** (Type 2 only)
- **SAFETY WRIST STRAP:** Always connect the safety strap to either wrist when jogging. This strap will keep the stroller from rolling away in the event that you trip while running. (Fig. 21) The safety strap must remain connected to the rear lower frame cross member at all times. This location is intended to prevent the stroller being tipped backward in the event that you do fall to the ground. The safety strap includes a Velcro attachment for storage, on the left side of the stroller, when not in use. (Fig. 22)
- **CALIPER BRAKE SYSTEM:** Squeeze the brake handle to slow the stroller. (Fig. 16) **NEVER** use the hand brake as a parking brake. This feature is only available on Type 1 stroller.

### TIRES

Tires are shipped un-inflated. The tires should be inflated on a regular basis to between 20 to 25 pounds of air pressure. Always use a bicycle style hand air pump to inflate the tires.

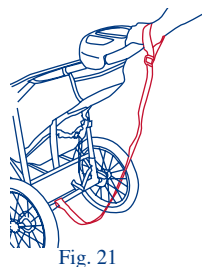

Fig. 21

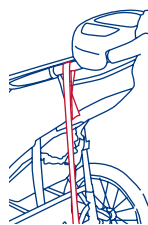

Fig. 22

### Handle Button Release

**⚠ WARNING:** Care must be taken when folding and unfolding the stroller to prevent finger entrapment.

#### TO FOLD STROLLER

Close the canopy as described in the canopy section. Recline seat by releasing buckle as described in seatback positioning section.

The stroller is folded by simultaneously depressing the safety lock on the right side and fold buttons located on the central joints. (Fig. 23) When the fold latches are released, the handle will begin to fall toward the floor. Release the fold buttons and press downward on the stroller handle until the stroller is completely folded. Secure the stroller in the folded position by hooking the fold latch, located on the right side of the stroller, over the rivet that protrudes from the frame. (Fig. 24)

**⚠ WARNING:** Care must be taken when folding and unfolding the stroller to prevent finger entrapment.

#### TO UNFOLD STROLLER

Stand the stroller on the ground with all three wheels touching the ground. Release the folding latch, which is located on the right side. (Fig. 25)

Lift up on the stroller handle with both hands until the stroller frame is erect and locked in the open position. (Fig. 26) The stroller has spring-loaded latches on both sides of the frame. Test that both latches are fully engaged prior to placing your child in the stroller.

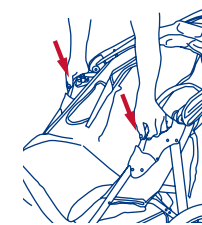

Fig. 23

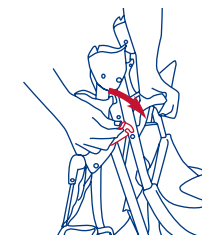

Fig. 24

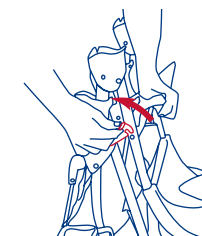

Fig. 25



Fig. 26

### Trigger Release

**⚠️ WARNING:** Care must be taken when folding and unfolding the stroller to prevent finger entrapment.

#### TO FOLD STROLLER

Close the canopy as described in the canopy section. Recline seat by releasing buckle as described in seatback positioning section.

The stroller is folded by simultaneously pulling each trigger fold. (Fig. 23) When the fold latches are released, the handle will begin to fall toward the floor. Release the fold buttons and press downward on the stroller handle until the stroller is completely folded. Secure the stroller in the folded position by hooking the fold latch, located on the right side of the stroller, over the rivet that protrudes from the frame. (Fig. 24)

**⚠️ WARNING:** Care must be taken when folding and unfolding the stroller to prevent finger entrapment.

#### TO UNFOLD STROLLER

Stand the stroller on the ground with all three wheels touching the ground. Release the folding latch, which is located on the right side. (Fig. 25)

Lift up on the stroller handle with both hands until the stroller frame is erect and locked in the open position. (Fig. 26) The stroller has spring-loaded latches on both sides of the frame. Test that both latches are fully engaged prior to placing your child in the stroller.

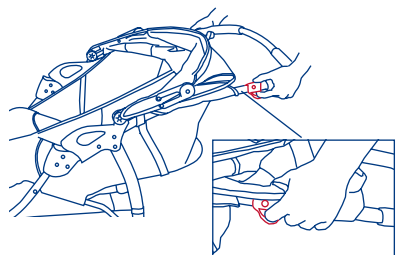

Fig. 23

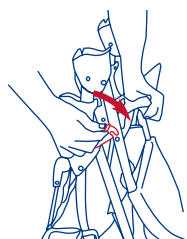

Fig. 24

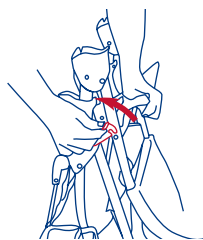

Fig. 25

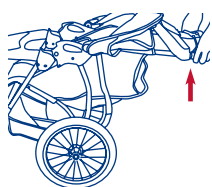

Fig. 26

### STROLLER PULLS TO ONE SIDE:

#### TYPE 1: FIXED FRONT WHEEL

The fixed front wheel jogging stroller is unusual in that it has no swiveling front wheel. Therefore, the stroller may at times feel like it is pulling to one side. This problem can have two different causes, either individually or in combination. Please perform the following steps in their numbered order.

1. The stroller is sensitive to the air pressure in the tires. If the rear tires do not have equal pressure, the stroller will feel like it is pulling to the side with the tire with the lower tire pressure. Check that the rear tires have the same pressure. Add air pressure to a maximum of 25 pounds using a **BICYCLE STYLE HAND AIR PUMP**.
2. The alignment of the front wheel of the stroller can also cause the stroller to pull to one side. The stroller is designed so that the front wheel can be adjusted to correct for any alignment problem. Page 3 of the instructions shows an expanded view of the front fork assembly. To align the front wheel, first loosen the wheel via the quick release handle as in step 2 of the instructions. Grab the front wheel directly in front of the stroller and push the wheel in the opposite direction of the pulling problem. You will notice that the axle will move within the slot on the fork. Move the wheel to the side a small amount. Retighten the quick release handle. Give the empty stroller a push across an empty smooth surface (let go of the handle) and note if the stroller now runs straight. Re-adjust the axle a small amount at a time until the stroller runs straight. Please note that a very minute movement of the axle will affect the tracking of the stroller. Once you have aligned the front wheel, you can mark the holding plate position with a marking pen if you detach the front wheel on a regular basis. Please note that the hole in the fork is designed to allow the stroller to be adjusted to pull to the right, go straight, or pull to the left. If you continue to have difficulty with tracking, please call our customer service department at 1-800-328-7363 for assistance.

### CALIPER BRAKE DOES NOT SLOW THE STROLLER DOWN:

The jogging stroller is equipped with a bicycle style caliper brake to assist you in slowing the stroller. It is designed with a quick release lever for ease in detaching the front wheel of the stroller. If you are experiencing inadequate slowing when applying the hand brake, please review the drawing below in the instruction manual to ensure that the quick release lever is in the down position (i.e. facing the front of the stroller). If the quick release lever is in the closed position and you are still experiencing a braking problem, the brake cable tension needs to be adjusted. This is accomplished in two different ways. If the brake is slowing the stroller slightly, the cable tension can be fine tuned via the tension nut located on the end of the brake cable just above the caliper. Turn the tension nut counter clockwise to increase tension. If at the maximum adjustment of the tension nut you still do not have adequate braking, you will need to adjust the length of the brake cable. To adjust the length of the cable, first return the tension nut to its factory setting by turning it clockwise until it stops. Loosen the cable clamp nut that holds the brake cable to the brake caliper. Squeeze the caliper together so that the brake pads are just touching the rim of the front wheel. Pull the cable through the cable clamp nut until the slack is removed. Retighten the cable clamp nut. Retest the braking and fine tune the tension via the tension nut until adequate slowing is achieved. Please keep in mind that the brakes are designed to be adjustable in order to compensate for the wearing of the brake pads over time. If you experience difficulty, please call our customer service department at 1-800-328-7363 for assistance. Also, most bicycle shops can quickly perform this adjustment for you.

#### Reverse steps if brakes are too tight.

