

**Read all instructions BEFORE assembly and USE of product.
KEEP INSTRUCTIONS FOR FUTURE USE.**

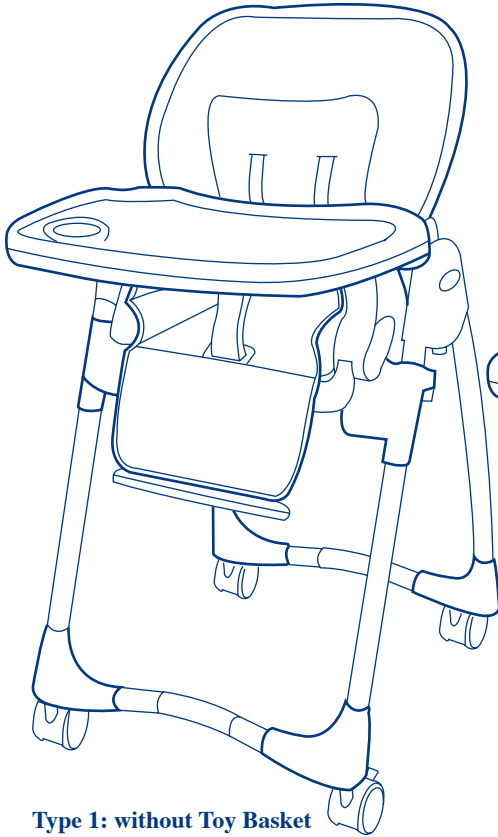

Type 1: without Toy Basket

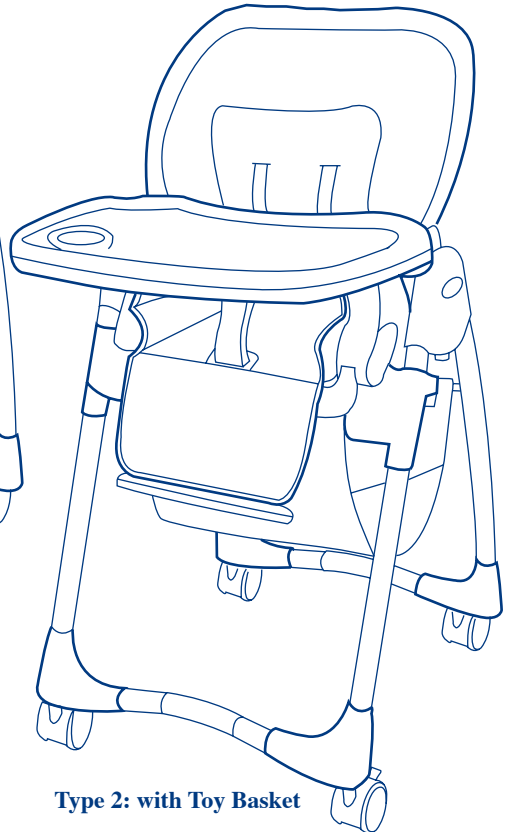

Type 2: with Toy Basket

Instruction Manual

baby trend[®]

Convenience through innovation and thoughtful design

www.babytrend.com

11.07

WARNING

⚠ WARNING: Failure to follow these warnings and the instructions could result in serious injury or death.

⚠ WARNING: The tray is not designed to hold the child in the chair. The child must be secured by the safety harness at all times while in the high chair.

⚠ WARNING: Prevent serious injury or death from falls or sliding out. Always secure child in the 5-point harness system either in the reclining, semi-reclining or upright position. The tray is not designed to hold the child in the chair. Always keep child in view while in high chair. Never leave child unattended. It is recommended that the high chair be used in the upright position only by children capable of sitting upright unassisted. See page 5 for instructions on proper use of restraint system.



- Accessory items may change the balance of the high chair and cause hazardous unstable conditions.
- Be certain the high chair is fully erect and latched in the open position before allowing the child near the high chair.
- Use of the high chair with a child weighing more than 45 pounds will cause excessive wear and stress on high chair.
- **NEVER** allow your high chair to be used as a toy.
- **NEVER** use this product if there are any loose or missing fasteners, loose joints, broken parts, or torn mesh/fabric. Check before assembly and periodically during use. Contact Baby Trend Customer Service at 1-800-328-7363 for replacement parts, repair or instructions. **NEVER** substitute parts.

MAINTENANCE AND CLEANING INSTRUCTIONS:

Use only household mild soap and warm water.
NO BLEACH. DO NOT MACHINE WASH.

PARTS

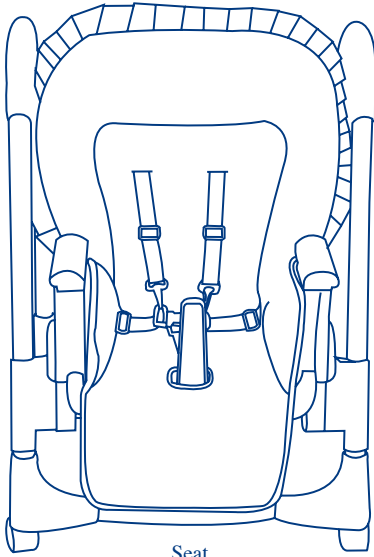

Seat

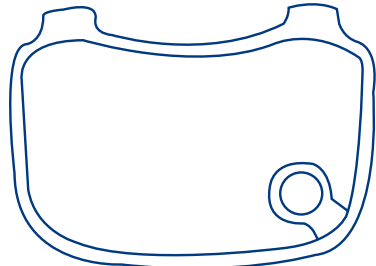

Tray



Caster (4)

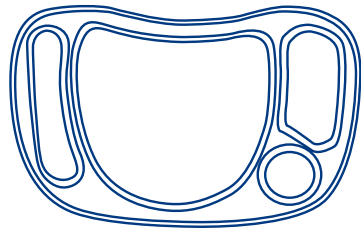

Dishwasher safe food tray

If you experience any difficulty with the use of our product or have a question regarding these instructions, please contact our Customer Service Department at 1-800-328-7363 between the hours of 8:00 a.m. and 4:30 p.m. (PST). Please do not return the product to the store as once it is returned it cannot be re-sold and the materials and energy used to make it are wasted.

Contact us by mail:
Baby Trend, Inc.
1567 S. Campus Ave., Ontario, CA 91761

Contact us by phone:
1-800-328-7363 (8:00am ~ 4:30pm PST)
or online <http://www.babytrend.com>

IMPORTANT! To ensure safe operation of your product, please follow these instructions carefully. Please keep these instructions for future reference.

IMPORTANT! Before assembly and each use, inspect this product for damaged hardware, loose joints, missing parts or sharp edges. NEVER use if any parts are missing or broken.

IMPORTANT! Adult assembly is required.

IMPORTANT! Always check that the high chair is locked in the open position before using.

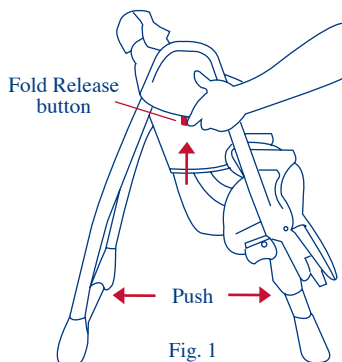

ATTENTION:

Carefully remove high chair from box. The high chair is shipped fully assembled except for the casters and tray.

TO ASSEMBLE FRAME

Depress the fold release buttons located on the top of the frame and push the legs apart until fully open and locked. (Fig. 1)

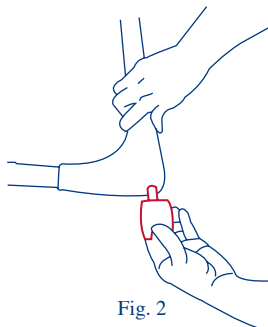

TO ASSEMBLE WHEELS

1. To attach the wheels, gently lay frame on its side.
2. Insert wheel into bottom of frame. Apply pressure and push the wheel all the way in until wheel secured. (see Fig. 2)

Repeat for the remaining wheels.

TO ATTACH AND OPERATE TRAY

To attach the tray, line up the grooves on the bottom of the tray with the armrests of the high chair. Squeeze the tray release handle (Fig. 3) and slide the tray onto the armrest (Fig.4). The tray has a 3-position adjustment.

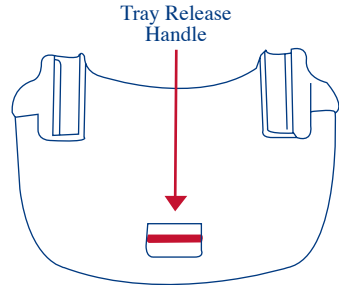

Fig. 3

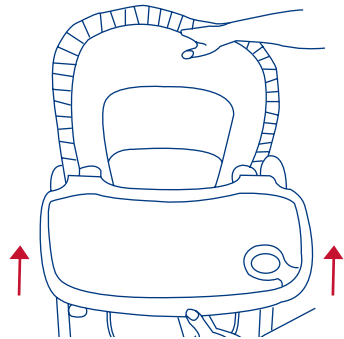

Fig. 4

To adjust the position, squeeze the tray release handle located underneath the tray and reposition the tray to the desired position. (Fig.5). Release tray release handle. Check that the tray is securely locked in it's new position.

The dishwasher safe food tray snaps onto the high chair tray and is held in place by tabs on either side of the tray. When installing the food tray make sure that it snaps into place to prevent the child from removing the food tray. To remove the food tray, carefully lift outward on the tabs on each side.

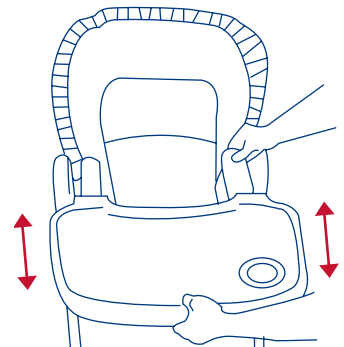

Fig. 5

⚠ WARNING: Failure to follow these warnings and the instructions could result in serious injury or death.

⚠ WARNING: It is recommended that only children capable of sitting upright unassisted use the high chair in the upright position.

⚠ WARNING: Prevent serious injury or death from falls or sliding out. Always secure child in the restraint system, either in the reclining, semi-reclining or upright position.

⚠ WARNING: Do not adjust seat height with child in seat. Adjust seat height before placing your child in the high chair.

⚠ WARNING: Always check that the height adjustment bracket is level and both left and right sides locked before placing child in the high chair.

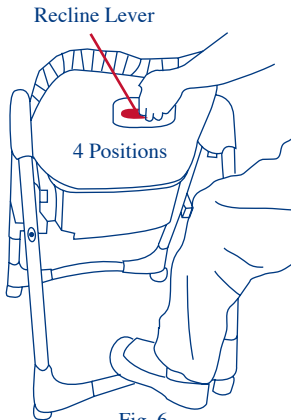

Fig. 6

RECLINE SEAT

Squeeze recline lever on back of the seat and adjust to the preferred recline or upright position. (Fig.6)

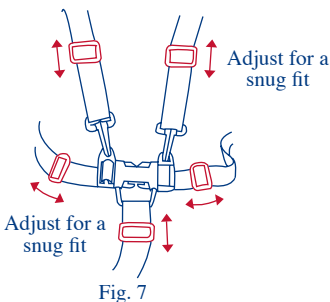

Fig. 7

SAFETY BELT

1. Place your child's arms through the loops formed by the shoulder and waist straps. Place the crotch strap between your child's legs. Insert the harness buckles into the center buckle to fasten.
2. Adjust shoulder and waist straps for your child's comfort and safety by sliding buckles in either direction. Safety straps are to fit snug around your child. (see Fig. 7)

- To release, squeeze the buckles to unfasten. (Fig. 8)

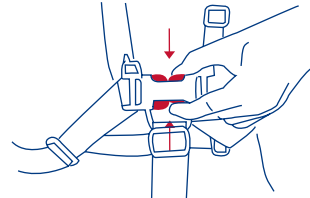

Fig. 8

ADJUST SEAT HEIGHT

Squeeze the levers on the height adjustment bracket and adjust to the ideal position. (Fig. 9)

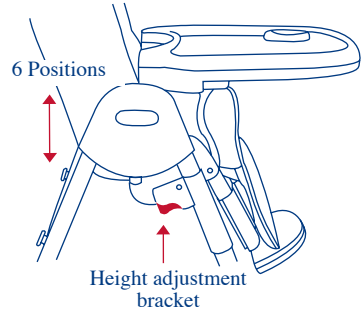

Fig. 9

TO FOLD HIGH CHAIR

The high chair may be folded with the seat in any of the height positions. The high chair will be the most compact with the seat in the lowest position, though the tray will only hang with the seat in the highest position.

- Place seat in the desired height position (Fig. 9).
- Place seat back in the most upright position.
- Squeeze the tray release handle and slide the tray out. (Fig. 10)
- Hang the tray (Fig. 11a) on the hooks located on the back of the rear leg. (Fig. 11b)

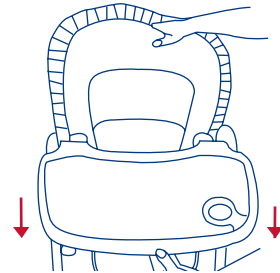

Fig. 10

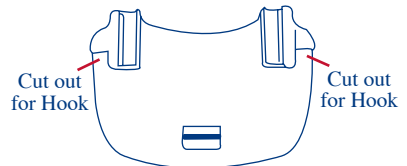

Fig. 11a

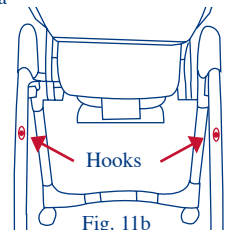

Fig. 11b

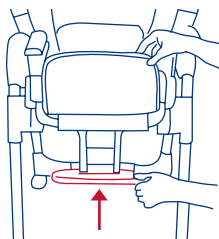

Fig. 12

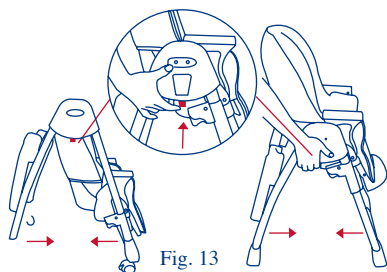

Fig. 13

5. Fold up the footrest. (Fig. 12)

6. Depress in the release buttons (located on the sides of the frame) and push the front legs in the direction of the rear legs until locked. (Fig. 13) Chair is now ready to be put away.

MAINTENANCE AND CLEANING INSTRUCTIONS:

Dishwasher safe food tray:

The food tray is dishwasher safe to 160° degrees Fahrenheit. **DO NOT USE SCOURING PADS** on the Dishwasher food tray as they will damage the surface and the tray will become more difficult to clean.

High Chair/Tray:

Clean high chair after each use using mild household detergents. Please use only a soft bristle brush, sponge or cloth to surface clean or remove particles of food. **DO NOT** submerge high chair tray in water: Surface clean only.

To remove pad for washing:

Unsnap the shoulder straps from the waist belt buckle and push through hole in pad. Push waist belt buckles and crotch strap through holes in pad. Gently pull upward on pad to remove. Wash pad with warm water, soap and a sponge for light stains. For a complete wash **DRY CLEAN ONLY. DO NOT MACHINE WASH OR DRY SEAT PAD. DO NOT USE BLEACH.** Hang to dry. Replace pad and rethread safety harness in reverse order.

From time to time check your high chair for loose screws, worn parts, torn material or stitching. Replace or repair the parts as needed. Excessive exposure to the sun or heat could cause fading, yellowing or warping of parts.