



**IF YOU EXPERIENCE ANY DIFFICULTY IN USING THIS PRODUCT,
PLEASE CONTACT OUR CUSTOMER SERVICE DEPARTMENT AT
1-800-328-7363 BETWEEN THE HOURS OF 8:00 A.M. AND 4:30 P.M. PACIFIC
STANDARD TIME FOR ASSISTANCE. PLEASE HAVE YOUR MODEL NUMBER AND
MANUFACTURING DATE AVAILABLE WHEN YOU CALL. THIS INFORMATION CAN BE
FOUND ON A SMALL STICKER ON THE INSIDE OF THE STROLLER FRAME.**



Convenience through innovation and thoughtful design

**Contact us by mail:
Baby Trend, Inc.
1567 S. Campus Ave., Ontario, CA 91761**

**Contact us by phone:
1-800-328-7363 (8:00am ~ 4:30pm PST)
or online <http://www.babytrend.com>**

Read all instructions BEFORE assembly and USE of product.
KEEP INSTRUCTIONS FOR FUTURE USE.

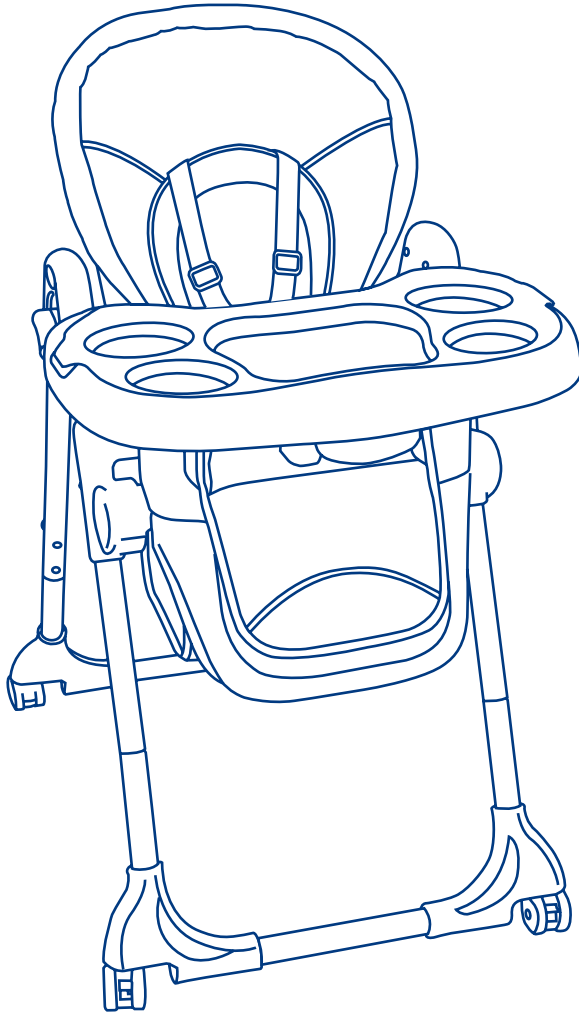

Instruction Manual

baby trend

Convenience through innovation and thoughtful design

www.babytrend.com

01.08

WARNING

⚠ WARNING: Failure to follow these warnings and the instructions could result in serious injury or death.

⚠ WARNING: The tray is not designed to hold the child in the chair. The child must be secured by the safety harness at all times while in the high chair.

⚠ WARNING: Prevent serious injury or death from falls or sliding out. Always secure child in the 5-point harness system either in the reclining, semi-reclining or upright position. The tray is not designed to hold the child in the chair. Always keep child in view while in high chair. Never leave child unattended. It is recommended that the high chair be used in the upright position only by children capable of sitting upright unassisted. See page 5 for instructions on proper use of restraint system.



- Other accessory items may change the balance of the high chair and cause hazardous unstable conditions, use approved Baby Trend toys.
- Be certain the high chair is fully erect and latched in the open position before allowing the child near the high chair.
- Use of the high chair with a child weighing more than 40 pounds will cause excessive wear and stress on high chair.
- The maximum weight that can be carried in the basket is 5 lb. Excessive weight may cause a hazardous unstable condition to exist.
- **NEVER** allow your high chair to be used as a toy.
- **NEVER** use this product if there are any loose or missing fasteners, loose joints, broken parts, or torn mesh/fabric. Check before assembly and periodically during use. Contact Baby Trend Customer Service at 1-800-328-7363 for replacement parts, repair or instructions. **NEVER** substitute parts.

If you experience any difficulty with the use of our product or have a question regarding these instructions, please contact our Customer Service Department at 1-800-328-7363 between the hours of 8:00 a.m. and 4:30 p.m. (PST). Please do not return the product to the store as once it is returned it cannot be re-sold and the materials and energy used to make it are wasted.

Contact us by mail:
Baby Trend, Inc.
1567 S. Campus Ave., Ontario, CA 91761

Contact us by phone:
1-800-328-7363 (8:00am ~ 4:30pm PST)
or online <http://www.babytrend.com>

PARTS

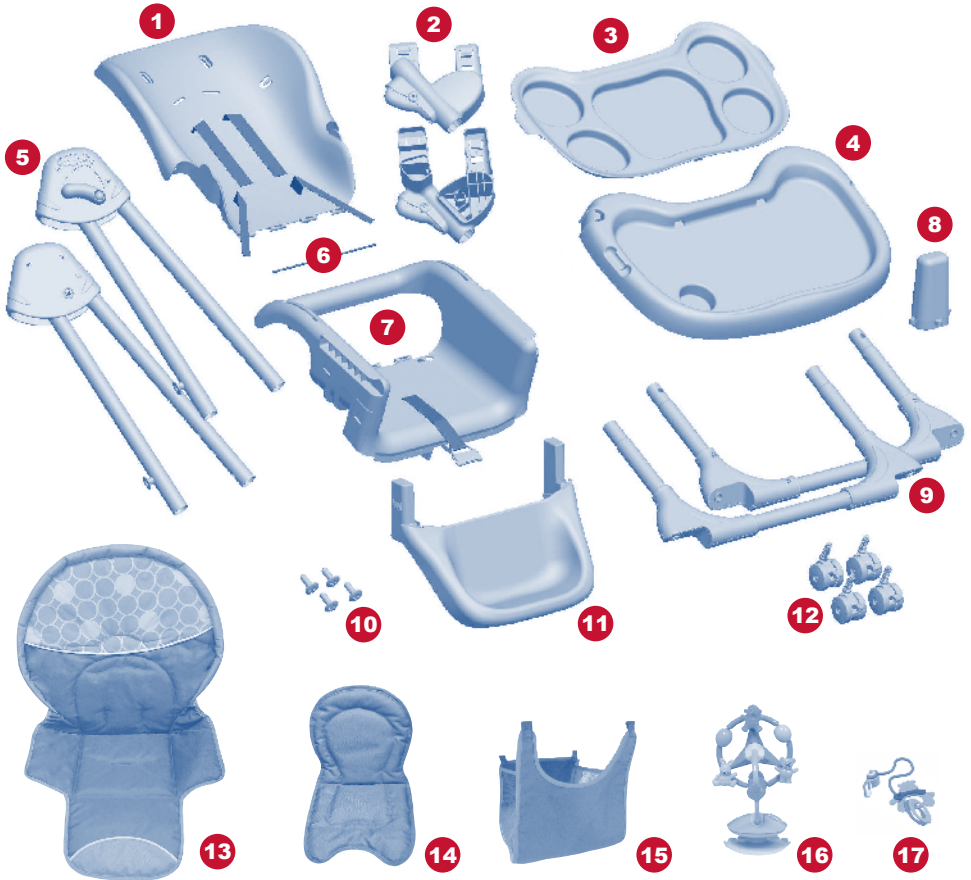

- 1 Seat Back
- 2 Height Brackets
- 3 Tray Insert
- 4 Tray
- 5 Upper Frame Assembly
- 6 Seat Back Hinge Rod
- 7 Seat Base
- 8 Crotch Retainer
- 9 Legs
- 10 4 (3.5mm x 10) Screws
- 11 Footrest
- 12 4 Casters (with brakes)
- 13 Seat Pad
- 14 Seat Insert (optional)
- 15 Basket (optional)
- 16 Music Toy (optional)
- 17 Teething Toy (optional)

IMPORTANT! To ensure safe operation of your product, please follow these instructions carefully. Please keep these instructions for future reference.

IMPORTANT! Before assembly and each use, inspect this product for damaged hardware, loose joints, missing parts or sharp edges. NEVER use if any parts are missing or broken.

IMPORTANT! Adult assembly is required.

IMPORTANT! Always check that the high chair is locked in the open position before using.

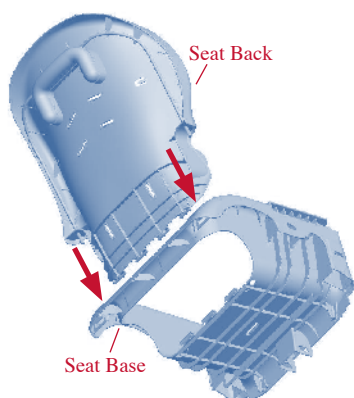

Fig. 1

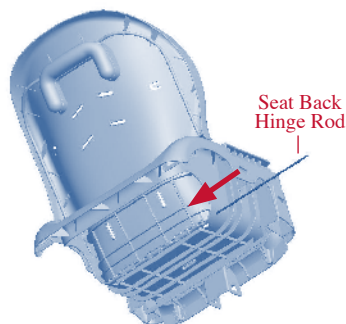

Fig. 2

ATTENTION:

Carefully remove parts from box. Check that you have all the parts for this model before assembling the high chair. NOTE: Certain High Chair models are packaged with the High Chair Seat Fabric and Seat Insert already attached to the Seat Back.

TO ASSEMBLE SEAT

1. Place the Seat Base on a flat surface as shown in figure 1.
2. Join the Seat Back to the Seat Base using the Seat Back Hinge Rod as shown in figure 2. The rod is inserted from right to left as shown.

- Slide the left and right sides' Height Bracket onto the Seat Base (Fig. 3). Snap the brackets in place (Fig. 4).

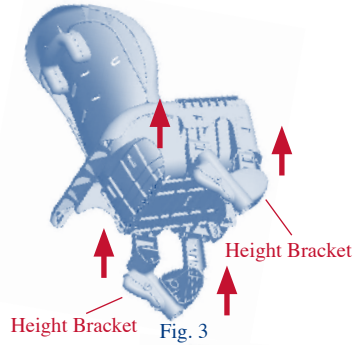

- Slide the Footrest onto the Seat Base as shown in Figure 5. Snap Footrest into place.

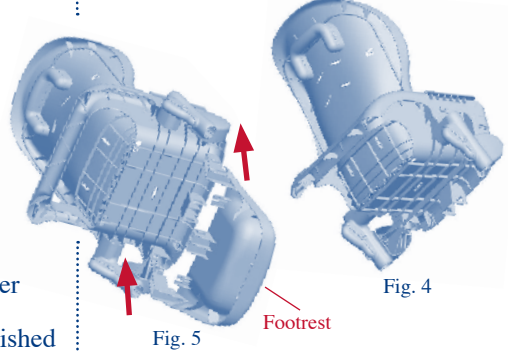

- Insert the front tube of the right side Upper Frame Assembly into the Height Bracket (Fig. 6). The front tube is easily distinguished from the rear tube by the array of holes located on the backside of the tube.

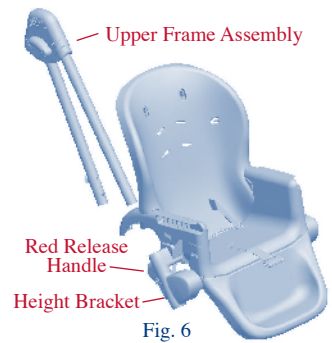

- Squeeze the Red Release Handle and push the tube through the Height Bracket until it locks on the highest position (Fig. 7).

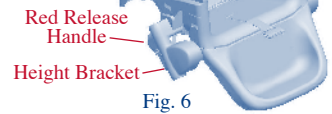

- Repeat Steps 5 and 6 for the left side Upper Frame Assembly (Fig. 8).

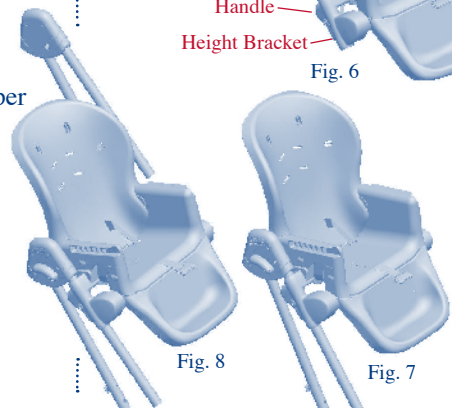

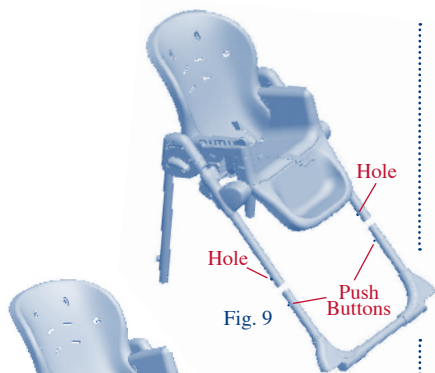

8. Insert the Legs into the ends of the front tube of both the right and left Upper Frame Assemblies (Fig. 9). Note: Legs are properly connected when the push buttons are lined up with the holes on the ends of the Upper Frame Assemblies. Make sure the push buttons are engaged before use.

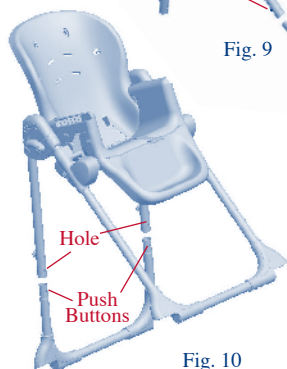

9. Insert another Leg into the ends of the rear tube of both the right and left Upper Frame Assemblies (Fig. 10).



10. Attach each of the Casters to the high chair feet as shown in Figure 11. Snap casters into Bottom of the foot. Check that all four Casters are securely fastened to the High Chair.

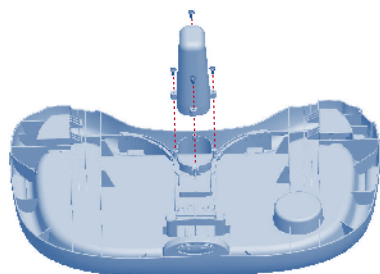

11. Flip over Tray to attach Crotch Retainer. The molded plastic housing must be oriented by facing the slot toward front of the Tray. Insert the 4 (3.5mm X 10) Screws and tighten. **DO NOT OVER-TIGHTEN** (Fig. 12).

TO ATTACH SEAT PAD

NOTE: Certain High Chair models are packaged with the High Chair Seat Pad and Seat Insert already attached to the Seat Back. If your model has a Seat Pad and Seat Insert on the Seat Back please skip ahead to Step 2.

1. Loop the flap on the back of the pad over the top of the Seat Back. Connect the Seat Pad to the Seat Back with the two Elastic Loops. These fit over the Attachment Tabs located near the top harness slots (Fig. 13).

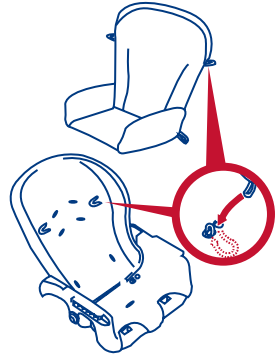

Fig. 13

2. Attach the bottom of Seat Pad to the Seat Base with the two Elastic loops located at the rear of the bottom of the Seat Pad. These fit over the Attachment Tabs located on the Seat Base near where the Seat Back and Seat Base Join. (Fig. 14)

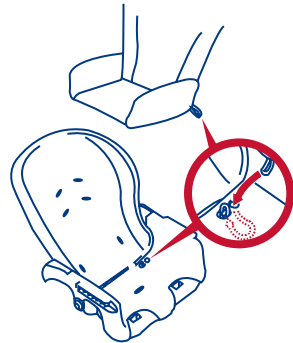

Fig. 14

3. Set Seat Insert onto Seat Pad.

4. Thread non-buckle end of Harness Straps called Harness Attachment Tabs through the provide slots in the Seat Fabric, Seat Insert, Seat Back, and Seat Base (Fig. 15). When Harness Attachment Tabs are through the provided slots, rotate the Harness Attachment Tabs 90 degrees. Make sure that the straps are firmly in place.

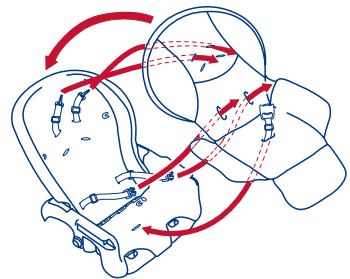
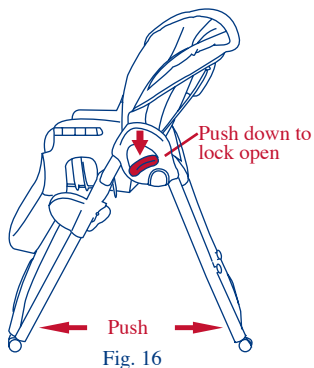

Fig. 15

TO REMOVE SEAT PAD

Reverse steps above.



OPEN HIGHCHAIR

Push the legs apart until fully open and locked. (Fig. 16) Push downward on fold levers (left and right) to ensure frame is locked open.

⚠️ WARNING: Always check that the high chair is locked in the open position before using.

⚠️ WARNING: The tray is not designed to hold the child in the chair. The child is to be secured by the safety belt at all times while in the high chair.

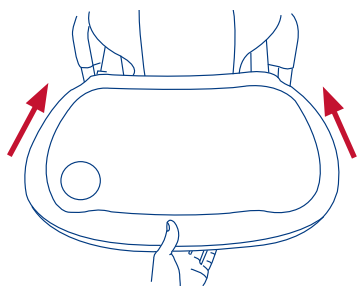

TO ATTACH AND OPERATE TRAY

TO ATTACH TRAY

To attach the Tray, line up the grooves on the bottom of the tray with the armrests of the high chair. Squeeze the Tray's release handle and slide the tray onto the armrests (Fig. 17). The Tray has a 3-position adjustment. To adjust the position, squeeze the Tray's release handle located underneath the tray and reposition the tray to the desired position (Fig. 18). Release the Tray's handle. Check that the Tray is securely locked in its new position.

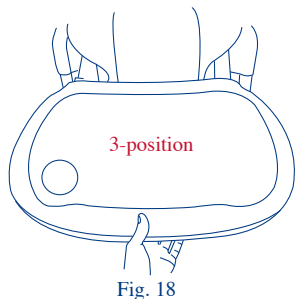

TO ATTACH INSERT TRAY

The dishwasher safe food Tray Insert snaps onto the High Chair Tray and is held in place by tabs on the sides of the Tray. When installing the Tray Insert make sure that its snaps into place to prevent the child from removing the Tray Insert. To remove Insert unsnap tabs from the Tray.

RECLINE SEAT

Squeeze recline lever on back of the seat and adjust to the preferred recline or upright position. (Fig.19). **When adjusting the seat back position, be very careful that the child's arms, hands or legs do not get caught.**

⚠ WARNING: It is recommended that only children capable of sitting upright unassisted use the high chair in the upright position.

⚠ WARNING: Prevent serious injury or death from falls or sliding out. Always secure child in the restraint system, either in the reclining, semi-reclining or upright position.

TO USE SAFETY BELT

The Tray is not designed to hold the child in the chair. Always keep child in view while in high chair. **NEVER LEAVE CHILD UNATTENDED.**

1. Place your child's arms through the loops formed by the shoulder and waist straps. Place the crotch strap between your child's legs. Insert the Harness Buckles into the Center Clasp with the Red Button.
2. Adjust shoulder and waist straps for your child's comfort and safety by sliding buckles in either direction. Safety straps are to fit snug around your child. (Fig. 20)

TO RELEASE SAFETY BELT

Push Red Button on Center Clasp, the two Harness Buckles will pop free. (Fig. 21)

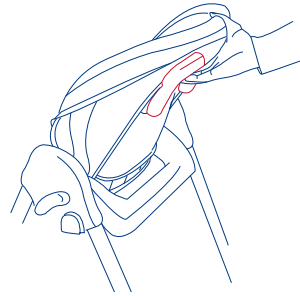
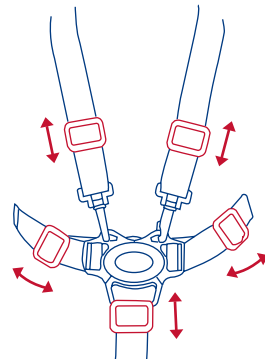

Fig. 19



Adjust for a snug fit
Fig. 20

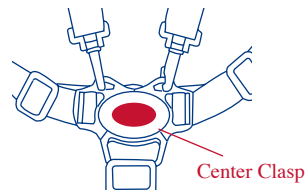

Fig. 21

Center Clasp

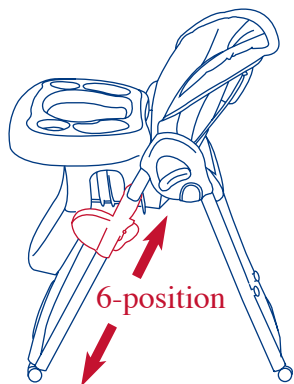

Fig. 22

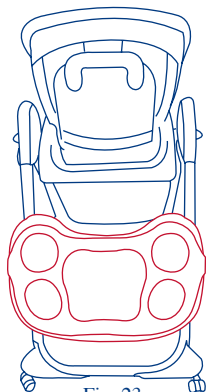

Fig. 23

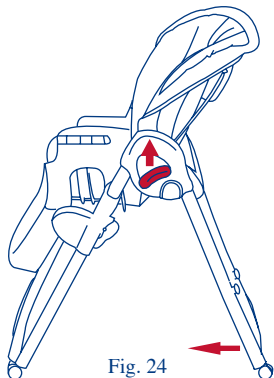

Fig. 24

⚠ WARNING: Do not adjust seat height with child in seat. Adjust seat height before placing your child in the high chair.

TO ADJUST SEAT HEIGHT

Squeeze both left and right lever of the Height Adjustment Bracket and adjust to the ideal position. (Fig. 22)

⚠ WARNING: Always check that the height adjustment bracket is level and both left and right sides locked before placing child in the high chair.

TO FOLD HIGH CHAIR

The High Chair may be folded with the seat in any of the height positions. The high chair will be the most compact with the seat in the lowest position.

1. Place seat in the desired height position (Fig. 23).
2. Place Seat Back in the most upright position (Fig. 19).
3. Squeeze the tray release handle and slide the tray out. (Fig. 17) Hang the tray on the hooks located on the back of the rear leg. (Fig. 23)
4. Pull upward on the release levers (located on the sides of the frame) and push the rear legs in the direction of the front legs until folded. (Fig. 24) Chair is now ready to put away. **DO NOT** allow your child to play around a folded high chair as it may fall.

TO UNFOLD HIGH CHAIR

Push the legs apart until fully open and locked. Push downward on the fold levers (left and right) to ensure the frame is locked. (Fig. 16)

TO ATTACH OR REMOVE TOY

TO ATTACH OR REMOVE MUSIC TOY

The Music Toy (Part # 16) is attached through the suction cup on the bottom of the Toy. To attach simply press the Toy on the Tray, to remove lift up a part of the bottom of the cup.

TO ATTACH OR REMOVE TEETHING TOY

Press the Teething Toy (Part # 17) connector into the curved slot in Tray edge and snap bottom of connector over lower lip of Tray. Reverse to remove the Toy (Fig. 25).

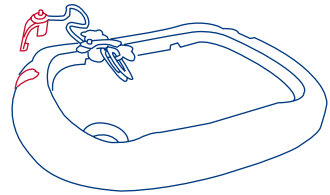

Fig. 25

CARE AND MAINTENANCE

⚠️WARNING: **Harness Straps and Basket are NOT washable.**

Dishwasher safe Tray Insert:

The Tray Insert is dishwasher safe to 160 degrees Fahrenheit. Do not use scouring pads on the Tray Insert as they will damage the surface and the Tray Insert will become more difficult to clean.

High Chair/Tray:

Clean High Chair and Tray after each use using mild household dish soap.

Please use only a soft bristle brush, sponge or cloth to clean the surface or remove particles of food. **DO NOT** submerge High Chair and Tray in water: Surface clean only.

To remove fabric pad for washing:

Remove Harness Straps by pushing Harness Attachment Tabs through the Harness slots on the Seat Back, Seat Base, and Seat Pad.

Remove Elastic Loops from Attachment Tabs on Seat Base and Seat Back.

Machine Wash COLD DELICATE CYCLE with non chlorine based Laundry Detergent.

HANG DRY. DO NOT USE BLEACH. DO NOT MACHINE DRY.

Vinyl Pad:

Please use sponge or cloth with mild household detergents to surface clean the vinyl seat pad. DO NOT machine wash the vinyl seat pad. To remove the vinyl seat pad see above.

To attach or remove Basket

NOTE: Certain Models will have a Basket underneath the seat for storage. These Models will be packaged with the Basket already attached to the Seat Base.

To remove Basket

The Basket is attached by four snaps. Release these snaps for removal.

To attach Basket

Feed snap strips around Basket Slots underneath Seat Base. Press firmly on the four snaps.