



half buckle carrier

INSTRUCTION MANUAL

Baby Tula | babytula.com

IMPORTANT! KEEP INSTRUCTIONS FOR FUTURE REFERENCE AND USE.

WARNING: FALL AND SUFFOCATION HAZARD

FALL HAZARD – Baby can fall through a wide leg opening or out of carrier.

- Before each use, make sure all fasteners are secure.
- Take special care when leaning or walking.
- Never bend at waist; bend at knees.
- DO NOT USE for babies weighing less than 7 lbs. (3.2 kg).
- Only use this Carrier for babies between 7 lbs. (3.2 kg) and 45 lbs. (20.4 kg).
- Babies must be carried only in the front inward-facing carry position.
- To prevent hazards from falling, ensure that your child is securely positioned in the carrier.

SUFFOCATION HAZARD – BABIES UNDER 4 MONTHS CAN SUFFOCATE IN THIS PRODUCT IF FACE IS PRESSED TIGHT AGAINST YOUR BODY.

- Do not strap baby too tight against your body.
- Allow room for head movement.
- Keep baby's face free from obstructions at all times.

WARNING:

- Constantly monitor your child and ensure that the mouth and nose are unobstructed when using this product.
- For pre-term, low birthweight babies and children with medical conditions, seek advice from a health professional before using this product.
- Ensure that your child's chin is not resting on his chest as his breathing may be restricted, which could lead to suffocation.
- Your balance may be adversely affected by your movement and that of your child.
- Take care when bending or leaning forward or sideways.
- Do not allow baby to insert his fingers into a buckle opening.
- Never leave baby unattended in or with the Tula Half Buckle Carrier.

- This carrier is not suitable for use during sporting activities, e.g. running, cycling, swimming and skiing.
- Take medical advice if you have concerns regarding the use of this product.
- Ensure that your child is securely positioned in the carrier and the head is sufficiently supported.

PRECAUTIONS FOR USE OF TULA HALF BUCKLE CARRIER:

Read all instructions before assembling and using the soft carrier. Practice putting on your Carrier before using.

Never use this product when balance or mobility is impaired because of exercise, drowsiness, or medical conditions. Never use this product while engaging in activities such as cooking and cleaning which involve a heat source or exposure to chemicals. Never wear a soft carrier while driving or being a passenger in a vehicle. Be careful when drinking hot beverage to avoid spilling hot drinks onto the baby while using the carrier. Never unbuckle the waist belt while the baby is in the Carrier. Be aware that as the baby becomes more active, the child has more risk of falling out of the carrier. Only carry one child at a time in the baby carrier.

Baby's chin should NEVER rest on baby's chest because this partially closes baby's airway. There should always be at least two fingers width clearance beneath baby's chin. Wearer must be sure that baby's airway is clear and that baby is breathing normally at ALL TIMES. Premature infants, infants with respiratory problems, and infants under 4 months are at greatest risk of suffocation. Ensure proper placement of baby in product including leg placement. The baby's position should be checked regularly to make sure that the baby is comfortable and properly seated in the Carrier, centered with legs extended and head upright and not slumping downward or to the side. Baby's arms, legs and feet need to be observed regularly while in the Carrier to ensure that they are not constricted by the Carrier. The carrier must be worn in such a way that a baby can move his head without pressing his face onto your body. When using the hood, please ensure that the hood is NOT completely covering baby's face and check on your baby regularly. Be sure that there is enough opening for air to pass through. Ensure that baby's fingers are not caught in a buckle opening or gap as this may cause injury to the baby. Always fasten the buckles properly when the carrier is not in use. Keep the carrier away from children when it is not in use. The face of the child shall be close to the wearer's face.

Check to assure all buckles, snaps, straps and adjustments are secure before each use. Regularly inspect the carrier for any sign of wear and damage. Never use a carrier when damaged in any way. Check for ripped seams, torn straps or fabrics and damaged fasteners before each use. Regularly check straps and buckles while in use to make sure they have proper tension and placement.

PRECAUTIONS FOR USE OF TULA HALF BUCKLE CARRIER CONT.

Do not switch between Carrier positions with your baby in the Carrier. Take the baby out of the Carrier before changing the position of the Carrier. To avoid injury when learning to place the baby in the Carrier, do so over a bed or other cushioned surface with the assistance of another adult. Whenever possible, wear and remove the carrier close to a safe receiving surface for baby and in a safe place. Take particular care when a baby is carried in a back carry position. For smaller babies or for adults with short torso, wear the carrier waist belt higher on body so baby's head is positioned close enough to kiss when using the front carry position. For those with longer torso, we suggest wearing the waist belt up higher, around the belly button level.

The Carrier should not be used unless and until the wearer understands the instructions and safety features, and is confident and comfortable with respect to the use of the Carrier. This Carrier is only intended for use by healthy adults. As a general rule, an individual in good health should be able to carry 20% of their body weight in a traditional backpack design. The Carrier should not be used by a person with any health problems that might interfere with the safe use of the product. If the person using the Carrier should develop shoulder, back, or neck problems, discontinue its use and consult a qualified medical professional. Discontinue use of the Carrier if the baby shows signs of discomfort while being carried for a period of time until the baby can be carried without exhibiting discomfort. Always check for baby's comfort and temperature changes.

Contact customer service representative for additional assistance if needed. For instructional video and additional tips, please visit www.babytula.com/pages/product-instructions

The references to ages by month are only general guidelines and each baby's development is different. Please check that your baby meets the specific requirements for use. In addition, Carrier is not to be used with babies less than 7 lbs. (3.2 kg) and less than 20 in (50.8 cm) tall.

table of contents

Warning Statement

About Us | About the Half Buckle Carrier

1 – 2

Instructions for Use

Set Up

3 – 6

Securing the Half Buckle Waist Belt

7

How to Tie a Knot

8

Front Carry

9 – 10

Hip Carry

11 – 12

Back Carry

13 – 14

Wash & Care | Disclaimer | Limited Warranty

15

Translated Warning Statements

17 – 43

about baby tula

Founded by two adventurous parents, Ula and Mike, Baby Tula bloomed organically in Ula's hometown in Poland. After learning about the many positive benefits of babywearing, the couple searched for a comfortable, ergonomic carrier that also spoke to their personal styles and desire for high quality. However, their search came up short.

With a passion for craftsmanship and design, they consulted with family, friends, babywearing experts, pattern makers, and chiropractors on their journey to making the first Baby Tula carrier. It was elegant, easy-to-use, and most importantly, allowed families to keep their little ones close while doing what they love.

Today, Baby Tula is an award-winning brand recognized not only for unique designs, but also for our commitment to promote connection and bonding worldwide through babywearing education and community.

Connect with Baby Tula and your community:



about the half buckle carrier

The Baby Tula Half Buckle Carrier is an ergonomic, adjustable baby carrier designed to grow with your baby from infancy to toddlerhood.

Product Features

- 1 Large front pocket on the contouring waist belt
- 2 Adjustable height
- 3 Adjustable width
- 4 Extra padding around leg opening for baby's comfort
- 5 Padded, crossable fabric shoulder straps to maximize comfort
- ♥ Can be used in front, back, and hip carries
- ♥ Provides an ergonomic M-position seat for baby's development
- ♥ Constructed from soft cotton fabric
- ♥ Comes with removable and adjustable hood

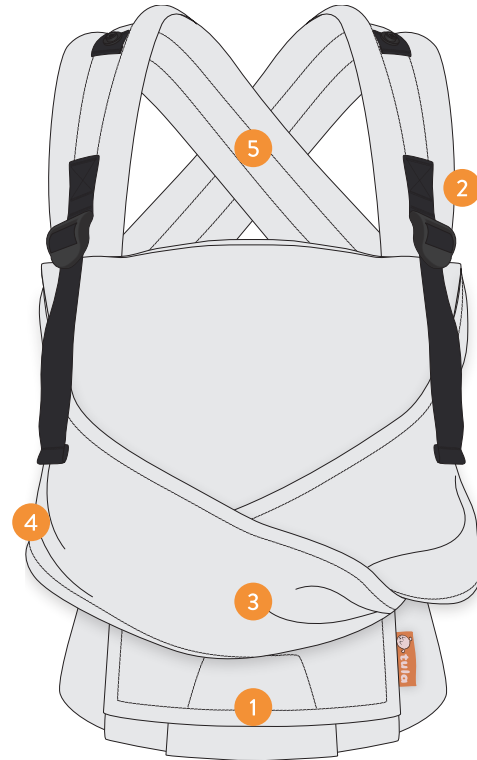

set up

How to Adjust the Half Buckle Panel

WIDTH:

The bottom of the carrier's panel, which is where your baby will sit, has three adjustable settings. Each setting can be secured using the durable snaps found along the inside waist belt of the carrier.

Start by adjusting the base of the carrier to the width appropriate for the baby's size.

Secure the front of the panel by snapping the male snaps into the female snaps located on the inside of the waist belt padding.

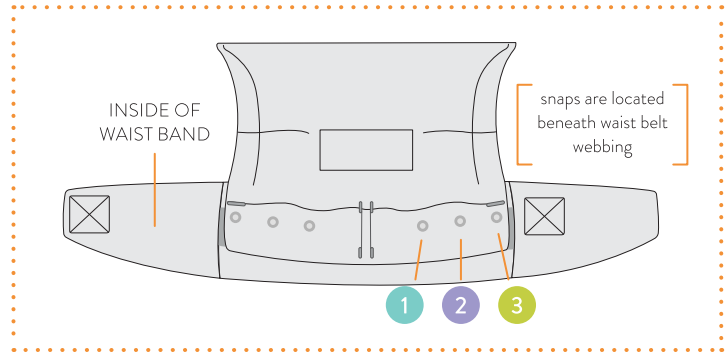
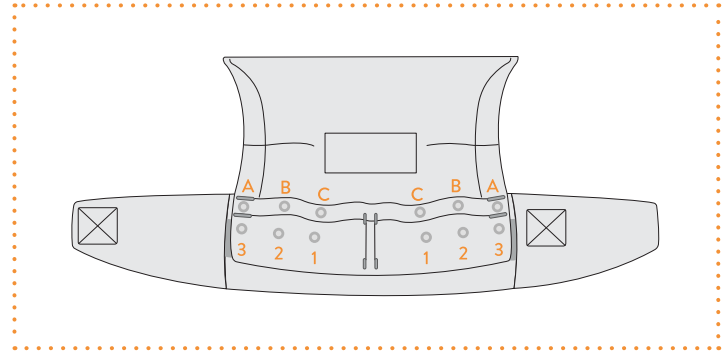

set up cont.

Narrow: Setting 1

The Narrowest Setting: Secure snap A to snap 1. The narrowest setting can be used for newborns and babies, with a minimum weight of **7 lbs / 3.2 kg (newborn – 3 months)**.

Middle: Setting 2

The Middle Setting: Secure snap A to snap 2, and secure snap B to snap 1. The middle setting can be used with babies **3-9 months of age**.

Wide: Setting 3

The Widest Setting: Secure snap A to snap 3, snap B to snap 2, snap C to snap 1. The widest setting is suitable for taller babies **9 months – 4 years**.

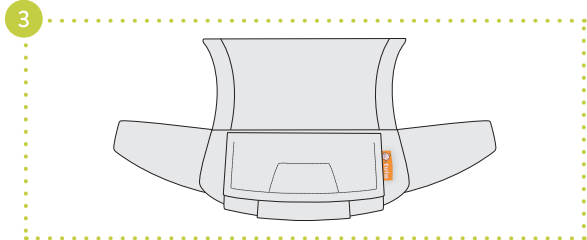
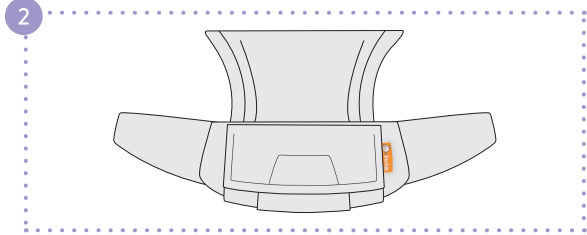
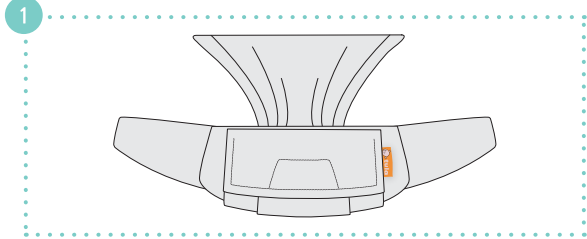

set up cont.

Correct Positioning

The width of the panel should be determined by the individual baby's comfort and leg span. The ergonomically correct position for baby is to be positioned with the base of the carrier supporting them from knee to knee, with their knees slightly higher than their bottom in an "M" shaped position.

When choosing which seat width to use with your baby, choose the width that supports their legs in an "M" shaped position with their legs supported to the crease of the knee. If the edge of the panel rests on the baby's calves, rather than under the bend in their knees, then the width you have chosen is too wide. Always ensure proper placement of baby in the carrier including leg placement.

How to Adjust the Half Buckle Panel

HEIGHT:

The panel of the carrier is also adjustable in height. There are two height positions – short and tall.

1. By cinching the webbing at the top of the panel down all the way, the panel can be adjusted to its shortest position, suitable for newborns and small babies weighting a minimum of 7lbs and minimum of 20cm in length.

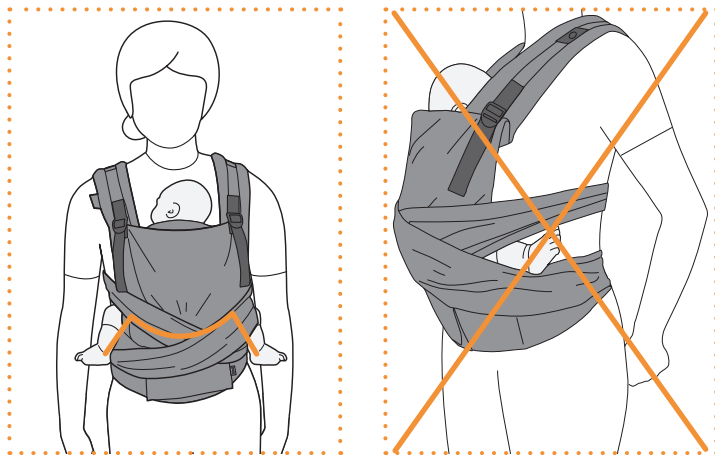

2. By releasing the webbing completely, the panel can be adjusted to its tallest position, suitable for larger babies and toddlers.
3. **Correct positioning:** When determining which panel height to use with your baby, choose a height that allows the baby's face to be visible over the top edge of the panel (see right).

set up cont.

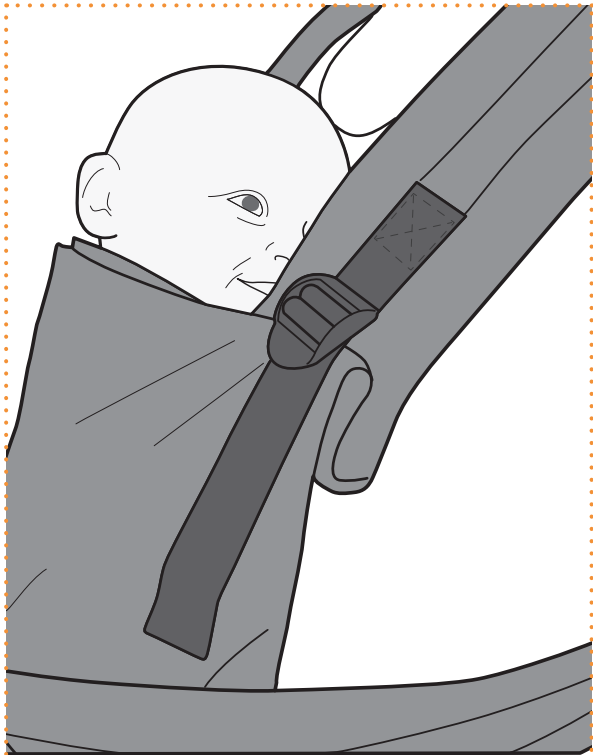

Short Position

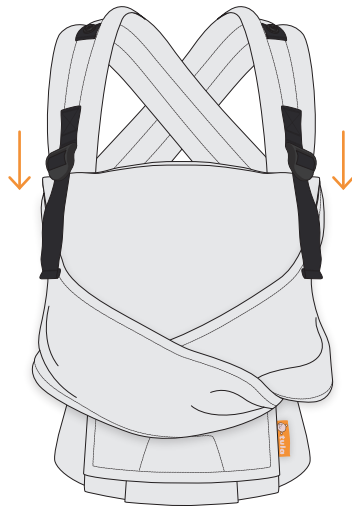

Tall Position



securing the half buckle waist belt

- 1 Position the waist belt around you with the labels facing inward, towards your body.
- 2 Start with the waist belt around your natural waist, adjusting up or down slightly to your comfort.

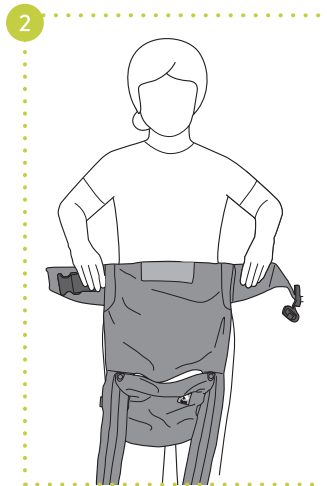
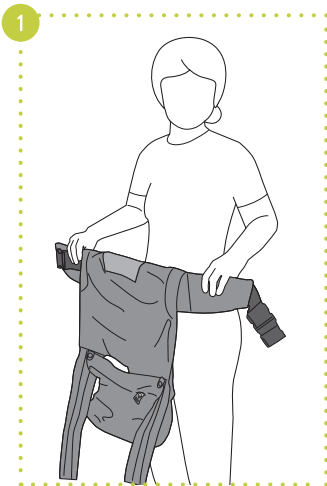

- 3 Feed the male buckle under the elastic strap and into the female buckle until you hear an audible click.

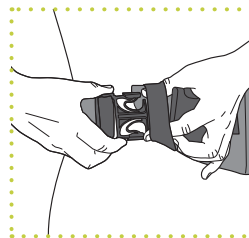

- 4 Tighten the waist belt by pulling on the adjustable webbing until it lays flat against your body, with no gaps or looseness.

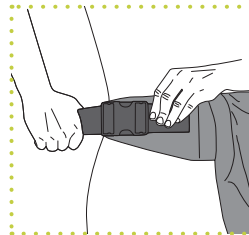

how to tie a knot

- 1 Take the two straps and lay strap A over strap B, then wrap strap A under strap B, bringing strap A back over strap B again.
- 2 Bring the end of strap A under the end of strap B.
- 3 Pull the end of strap B under strap A and pull on both ends firmly to tighten.

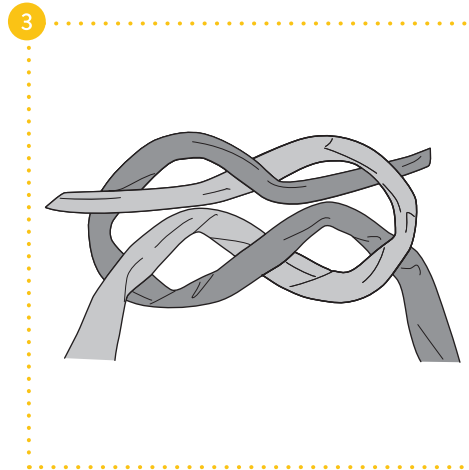
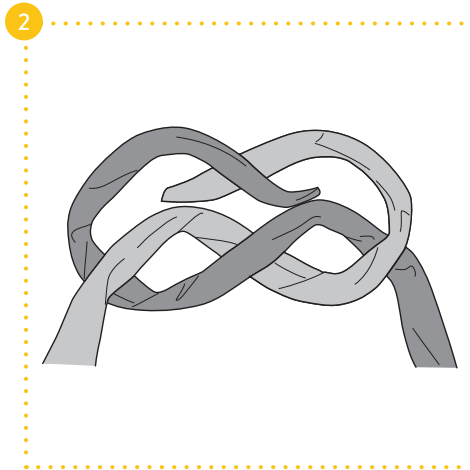
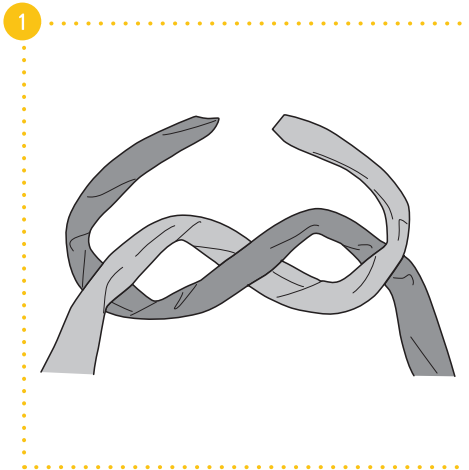



front carry instructions

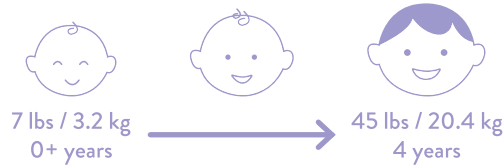

- 1 Position the waist belt so that the panel is centered on the front of your body.
- 2 Hold the baby so that they are positioned on your body with their legs in an “M” shaped position.
- 3 Use one hand to support the baby while using the other hand to smooth the panel up baby’s back.
- 4 Use your free hand to drape the first strap over your shoulder. Switch hands and drape the other strap over your other shoulder, making sure to keep one hand supporting baby.
- 5 Reach back with your free hand, take both straps and pull tight. Your child is now held firmly in the carrier.
- 6 While pulling the straps firmly, cross them evenly across your back.
- 7 Bring the straps around to your front, crossing them over baby’s back evenly and then thread them beneath baby’s legs.

- 8 Tie the straps with a double knot behind your back (see page 8).
- 9 Ensure that the baby’s bottom is seated deeply in the panel just above the waist belt by gently pushing up on baby’s calves. Baby should be seated in the “M” shaped position.

How to Take Off Carrier

- 10 To take baby out of the carrier, support baby with one hand while reaching behind you with your free hand and untie the knot.
- 11 Remove one strap at a time, while always using one hand to support the baby.
- 12 Lift baby up and out of carrier before unclipping the buckle on the waistband.

1

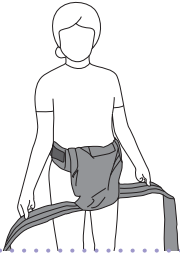

2



3



4



5



6

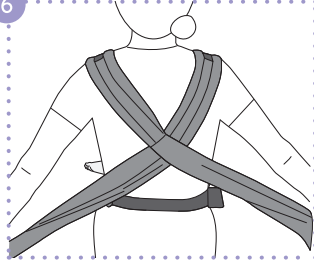

7

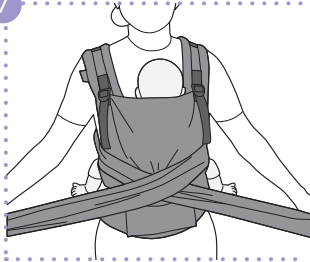

8



9



10



11



12





hip carry instructions

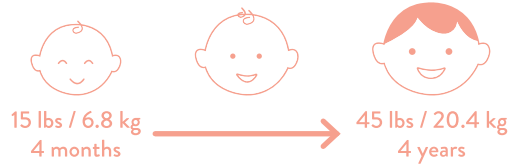

*Only use the hip carry position when baby has strong and consistent head and neck control.

- 1 Secure your waistband with the panel draped over your preferred hip.
- 2 Place baby on your hip and use one hand to hold baby in place while your free hand smooths the panel over baby's back.
- 3 While keeping one hand on baby's back, use your free hand to take the strap closest to your front and drape it over your shoulder.
- 4 Reach around and pull the other strap under your arm and straight across your back.
- 5 Take the ends of both straps and bring them to the front. Remove and slack from the straps and cross both straps over baby's bum.
- 6 Tie straps in a double knot behind you (see page 8).

How to Take Off Carrier

- 7 Place one hand on baby, keeping it supported while you untie the straps.
- 8 Remove one strap at a time, while always using one hand to support the baby.
- 9 Once baby is out of the carrier, you can unbuckle the waistband.

1



2a



2b



3



4

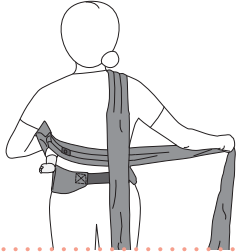

5



6

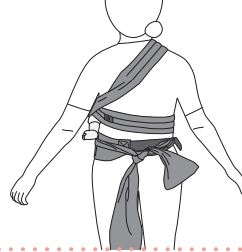

7



8



9





back carry instructions

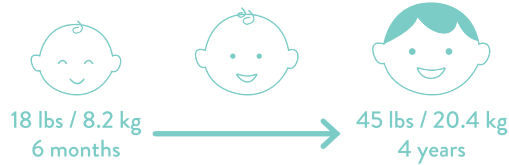

*Only use the back carry position when baby has strong and consistent head, neck, and torso control, who are able to sit unaided. The back carry can be used in either panel height and the middle or widest seat.

- 1 Position the waist belt so that the panel is centered on the back of your body and the waistband is buckled in the front.
- 2 Place baby on your hip and scoot baby around onto your back while you lean forward.
- 3 While keeping both hands on baby, make sure their body is centered on your back.
- 4 With one hand on baby, pull the panel of the carrier up between baby's legs and over their back.
- 5 Take one strap with each hand and pull them straight over your shoulders while you gently bounce baby into a deep seat.

- 6 Pull the straps in front of you and pull them under your arms, like backpack straps.
- 7 Cross the straps over baby's back and then thread them under baby's legs.
- 8 Bring the straps around to your front and tie them with a double knot (see page 8).

How to Take Off Carrier

- 9 Place one hand on baby, keeping them supported while you untie the straps.
- 10 Remove one strap at a time, while always using one hand to support the baby.
- 11 Slide baby around to your hip and lift them up and out of the carrier.

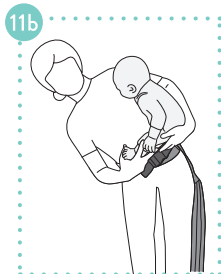
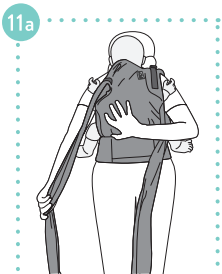
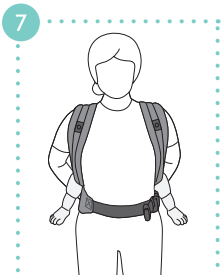
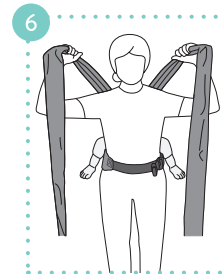
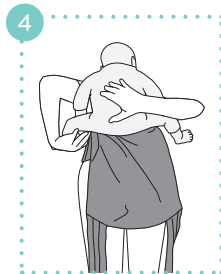
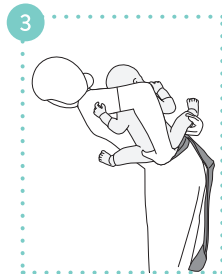
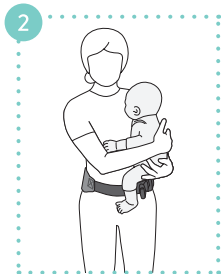
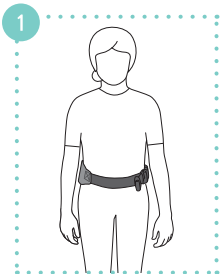

need more help getting the right fit?

Visit our YouTube channel
OR schedule a video fit check
with Team Tula at babytula.com



& don't forget!

Follow us on social for all
the latest Tula news



wash & care

Machine wash cold. Do not bleach. Line dry. Do not iron. Do not dryclean.

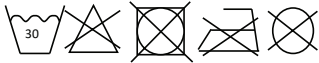

disclaimer

Baby Tula uses high quality dyes to ensure a product will retain its color as much as possible. There is always a possibility that colors will fade with washing. Baby Tula cannot be held responsible for faded colors due to laundering.

Contact Baby Tula customer service representative for additional assistance if needed.

limited warranty

Baby Tula provides a limited warranty for its products against defects in materials and workmanship. We stand behind all our products and will either repair or replace, free of charge during the first year after purchase, any Baby Tula product that is defective.

limited warranty cont.

All carriers, including the Explore, Half Buckle, Free-to-Grow, Tula Baby/Toddler Carriers, Woven Wraps, Ring Slings, and Wrap Conversion Carriers have a one-year limited warranty against manufacturing flaws. In the rare instance in which there is a manufacturing issue or flaw, we will work with you to provide you with a refund, repair, or exchange. Our products are handmade and may have slight variations that do not affect their use or safety. Normal wear, fabric fading, minor size differences, common/normal wrap nubs or flaws, and sewing varieties are not considered manufacturing flaws and are not covered under the limited warranty. We are not responsible for warranty coverage if the product has been altered in any way. The term "altered" is defined as including, without limit, dyeing, painting, embroidery, and fabric additions or removals made after purchase. We are also not responsible for warranty coverage for any item that has been purchased secondhand. Proof of purchase is required for all returns or exchanges.

Should you have a warranty claim please contact Customer Service:
EU: info@babytula.com
All other inquiries: help@babytula.com

Warranty Coverage does not extend to damage caused by misuse or any use of the Carrier that is not in accordance with the instructions stated in this manual. Warranty coverage does not extend to any Carrier that has been modified from its original construction in any way. Different or additional warranty rights may exist in the purchaser's jurisdiction. To the extent that different or additional warranty rights exist under the laws of the purchaser's jurisdiction, those warranties shall apply and be in addition to the warranty rights.





an expression of love



Baby Tula | **BabyTula.com** | help@babytula.com

US: 2640 Financial Ct. Suite E, San Diego, CA 92117 | 619.324.7563
PL: Komunalna 5, 15-197 Bialystok | +48.789.211.447