



explore carrier

INSTRUCTION MANUAL

Baby Tula | babytula.com

IMPORTANT! KEEP INSTRUCTIONS FOR FUTURE REFERENCE AND USE.

WARNING: FALL AND SUFFOCATION HAZARD

FALL HAZARD – Baby can fall through a wide leg opening or out of carrier.

- Before each use, make sure all fasteners are secure.
- Take special care when leaning or walking.
- Never bend at waist; bend at knees.
- DO NOT USE for babies weighing less than 7 lbs. (3.2 kg).
- Only use this Carrier for babies between 7 lbs. (3.2 kg) and 45 lbs. (20.4 kg).
- To prevent hazards from falling, ensure that your child is securely positioned in the carrier.
- Child must face towards you until he or she can hold head upright.
- DO NOT let baby sleep in outward facing position.

SUFFOCATION HAZARD – BABIES UNDER 4 MONTHS CAN SUFFOCATE IN THIS PRODUCT IF FACE IS PRESSED TIGHT AGAINST YOUR BODY.

- Do not strap baby too tight against your body.
- Allow room for head movement.
- Keep baby's face free from obstructions at all times.

WARNING:

- Constantly monitor your child and ensure that the mouth and nose are unobstructed when using this product.
- For pre-term, low birthweight babies and children with medical conditions, seek advice from a health professional before using this product.
- Ensure that your child's chin is not resting on his chest as his breathing may be restricted, which could lead to suffocation.
- Your balance may be adversely affected by your movement and that of your child.
- Take care when bending or leaning forward or sideways.
- Do not allow baby to insert his fingers into a buckle opening.

- Never leave baby unattended in or with the Tula Explore Carrier.
- This carrier is not suitable for use during sporting activities, e.g. running, cycling, swimming and skiing.
- Take medical advice if you have concerns regarding the use of this product.
- Ensure that your child is securely positioned in the carrier and the head is sufficiently supported.

PRECAUTIONS FOR USE OF TULA EXPLORE CARRIER:

Read all instructions before assembling and using the soft carrier. Practice putting on your Carrier before using.

Never use this product when balance or mobility is impaired because of exercise, drowsiness, or medical conditions. Never use this product while engaging in activities such as cooking and cleaning which involve a heat source or exposure to chemicals. Never wear a soft carrier while driving or being a passenger in a vehicle. Be careful when drinking hot beverage to avoid spilling hot drinks onto the baby while using the carrier. Never unbuckle the waist belt while the baby is in the Carrier. Be aware that as the baby becomes more active, the child has more risk of falling out of the carrier. Only carry one child at a time in the baby carrier.

Baby's chin should NEVER rest on baby's chest because this partially closes baby's airway. There should always be at least two fingers width clearance beneath baby's chin. Wearer must be sure that baby's airway is clear and that baby is breathing normally at ALL TIMES. Premature infants, infants with respiratory problems, and infants under 4 months are at greatest risk of suffocation. Ensure proper placement of baby in product including leg placement. The baby's position should be checked regularly to make sure that the baby is comfortable and properly seated in the Carrier, centered with legs extended and head upright and not slumping downward or to the side. Baby's arms, legs and feet need to be observed regularly while in the Carrier to ensure that they are not constricted by the Carrier. The carrier must be worn in such a way that a baby can move his head without pressing his face onto your body. When using the hood, please ensure that the hood is NOT completely covering baby's face and check on your baby regularly. Be sure that there is enough opening for air to pass through. Ensure that baby's fingers are not caught in a buckle opening or gap as this may cause injury to the baby. Always fasten the buckles properly when the carrier is not in use. Keep the carrier away from children when it is not in use. The face of the child shall be close to the wearer's face when in an inward facing position.

Check to assure all buckles, snaps, straps and adjustments are secure before each use. Regularly inspect the carrier for any sign of wear and damage. Never use a carrier when damaged in any way. Check for ripped seams, torn straps or fabrics and damaged fasteners before each use. Regularly check straps and buckles while in use to make sure they have proper tension and placement.

PRECAUTIONS FOR USE OF TULA EXPLORE CARRIER CONT.

Do not switch between Carrier positions with your baby in the Carrier. Take the baby out of the Carrier before changing the position of the Carrier. To avoid injury when learning to place the baby in the Carrier, do so over a bed or other cushioned surface with the assistance of another adult. Whenever possible, wear and remove the carrier close to a safe receiving surface for baby and in a safe place. Take particular care when a baby is carried in a back carry position. For smaller babies or for adults with short torso, wear the carrier waist belt higher on body so baby's head is positioned close enough to kiss when using the front carry position. For those with longer torso, we suggest wearing the waist belt up higher, around the belly button level.

The Carrier should not be used unless and until the wearer understands the instructions and safety features, and is confident and comfortable with respect to the use of the Carrier. This Carrier is only intended for use by healthy adults. As a general rule, an individual in good health should be able to carry 20% of their body weight in a traditional backpack design. The Carrier should not be used by a person with any health problems that might interfere with the safe use of the product. If the person using the Carrier should develop shoulder, back, or neck problems, discontinue its use and consult a qualified medical professional. Discontinue use of the Carrier if the baby shows signs of discomfort while being carried for a period of time until the baby can be carried without exhibiting discomfort. Always check for baby's comfort and temperature changes.

Contact customer service representative for additional assistance if needed. For instructional video and additional tips, please visit www.babytula.com/pages/product-instructions

The references to ages by month are only general guidelines and each baby's development is different. Please check that your baby meets the specific requirements for use. In addition, Carrier is not to be used with babies less than 7 lbs. (3.2 kg) and less than 20 in (50.8 cm) tall.

table of contents

.....

Warning Statement	
About Us About the Explore Carrier	1 – 2
Instructions for Use	
Set Up	3 – 6
Securing the Explore Waist Belt	7
Infant Positioning	8
Front Carry – Facing In	9 – 10
Front Carry – Facing Out	11 – 12
Back Carry	13 – 14
Using the Hood	15
Wash & Care	17
Disclaimer & Limited Warranty	17
Translated Warning Statements	19 – 45

about baby tula

Founded by two adventurous parents, Ula and Mike, Baby Tula bloomed organically in Ula's hometown in Poland. After learning about the many positive benefits of babywearing, the couple searched for a comfortable, ergonomic carrier that also spoke to their personal styles and desire for high quality. However, their search came up short.

With a passion for craftsmanship and design, they consulted with family, friends, babywearing experts, pattern makers, and chiropractors on their journey to making the first Baby Tula carrier. It was elegant, easy-to-use, and most importantly, allowed families to keep their little ones close while doing what they love.

Today, Baby Tula is an award-winning brand recognized not only for unique designs, but also for our commitment to promote connection and bonding worldwide through babywearing education and community.

Connect with Baby Tula and your community:



about the explore carrier

The Baby Tula Explore Carrier is an ergonomic, adjustable baby carrier designed to grow with your baby from infancy to toddlerhood.

Product Features

- 1 Adjustable height
- 2 Adjustable width
- 3 Padded neck support pillow that can be worn in three positions
- 4 Supportive shoulder padding for optimal comfort
- 5 Extra padding around leg opening for baby's comfort
- 6 Large front pocket on the contouring waist belt
- ♥ Can be used for front facing-in, front facing-out, and back carrying
- ♥ Provides an ergonomic M-position seat for baby's development
- ♥ Constructed from soft cotton fabric
- ♥ Comes with removable and adjustable hood

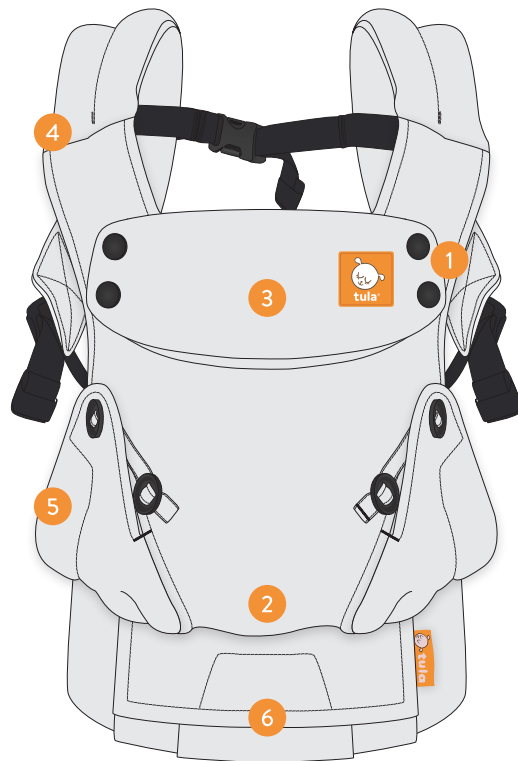

set up

How to Adjust the Explore Panel

WIDTH:

The bottom of the carrier's panel, which is where your baby will sit, has three adjustable settings. Each setting can be secured using the durable snaps found along the inside waist belt of the carrier.

Start by adjusting the base of the carrier to the width appropriate for the baby's size.

Secure the front of the panel by snapping the male snaps into the female snaps located on the inside of the waist belt padding.

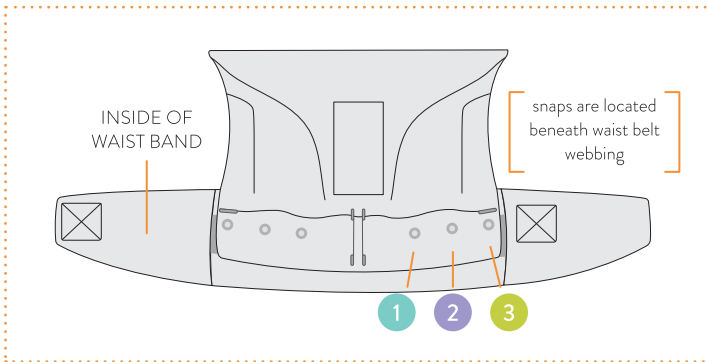
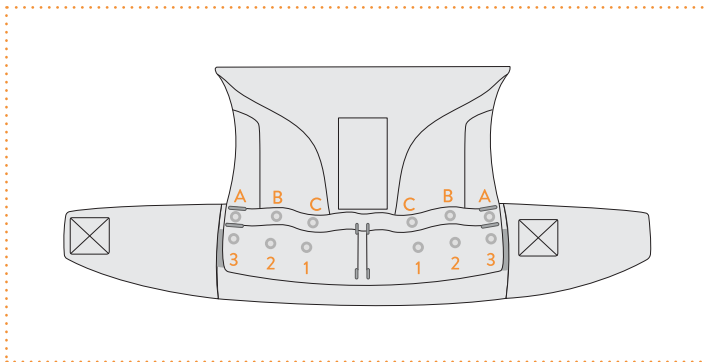

set up cont.

Narrow: Setting 1

The Narrowest Setting: Secure snap A to snap 1. The narrowest setting can be used for newborns and babies, with a minimum weight of **7 lb / 3.2 kg** (newborn – 3 months).

Middle: Setting 2

The Middle Setting: Secure snap A to snap 2, and secure snap B to snap 1. The middle setting can be used with babies **3 – 9 months of age**.

Wide: Setting 3

The Widest Setting: Secure snap A to snap 3, snap B to snap 2, snap C to snap 1. The widest setting is suitable for taller babies **9 months – 4 years**.

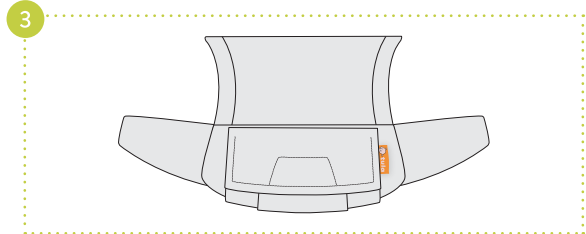
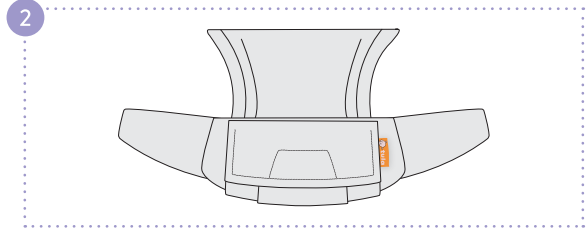
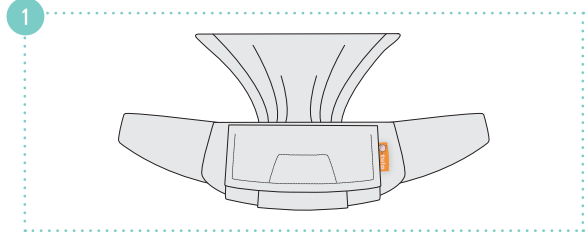

set up cont.

Correct Positioning – Inward Facing

The width of the panel should be determined by the individual baby's comfort and leg span. The ergonomically correct position for baby is to be positioned with the base of the carrier supporting them from knee to knee, with their knees slightly higher than their bottom in an "M" shaped position.

When choosing which seat width to use with your baby, choose the width that supports their legs in an "M" shaped position with their legs supported to the crease of the knee. If the edge of the panel rests on the baby's calves, rather than under the bend in their knees, then the width you have chosen is too wide. Always ensure proper placement of baby in the carrier including leg placement.

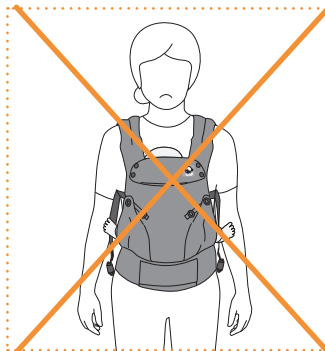

Correct Positioning – Outward Facing

- 1 Proper carrier set up is important to achieve an ergonomic carrying position when a child is facing out in the Explore carrier.
- 2 Be sure the seat is adjusted to the widest setting (page 3) whenever carrying a child in the facing out position.
- 3 Fasten the button holes on the outside thigh support to the lower set of buttons on the front of the carrier panel.
- 4 The neck support pillow should always be snapped into place on the outside of the carrier in the facing-out position.



set up cont.

How to Adjust the Explore Panel

HEIGHT:

The panel of the carrier is also adjustable in height. There are two height positions – short and tall.

1. Secure the neck support to the outside of panel using the snaps located on the outside edges of the carrier panel for the short carrier position.
2. To prepare the tall carrier panel position, secure the neck support to the inside of the shoulder straps by snapping the neck support in the upwards position into the snaps on the inside of the shoulder straps (use tall mode illustration).

Short Position

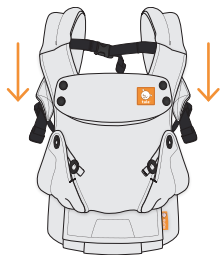

Tall Position

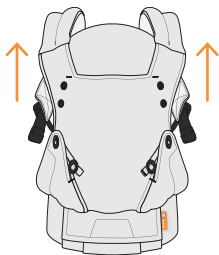

3. **Correct positioning:** When determining which panel height to use with your baby, choose a height that allows the baby's face to be visible over the top edge of the panel (see below).

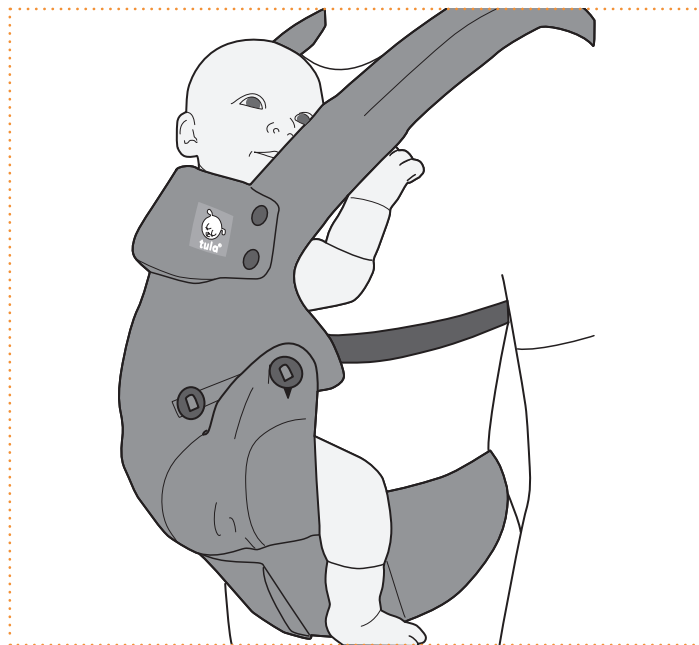

securing the explore waist belt

- 1 Position the waist belt around you with the labels facing inward, towards your body.
- 2 Start with the waist belt around your natural waist, adjusting up or down slightly to your comfort.

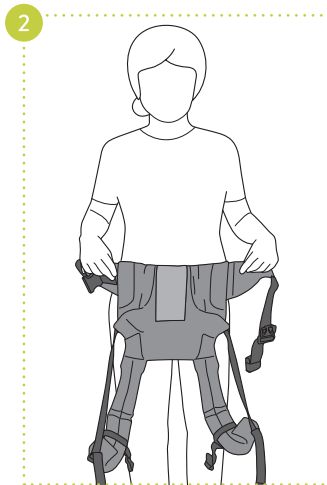
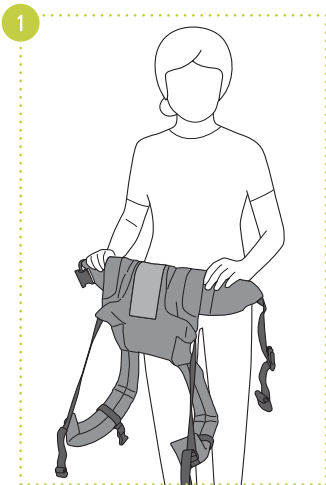

- 3 Feed the male buckle under the elastic strap and into the female buckle until you hear an audible click.

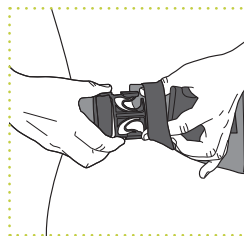

- 4 Tighten the waist belt by pulling on the adjustable webbing until it lays flat against your body, with no gaps or looseness.

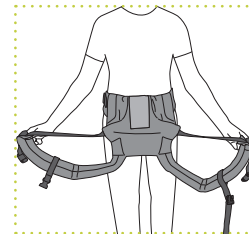
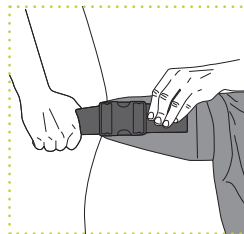

infant positioning

- 1 To prepare your Tula Explore for a newborn infant, adjust the width of the carrier to the narrowest setting (see page 4).
- 2 The neck support pillow should be positioned inside the carrier. To secure the support pillow in place, tuck each end of the support pillow into the interior flaps so that the snaps are no longer exposed.

***Infants should be worn on the front and facing in only.**

Inside View of Carrier

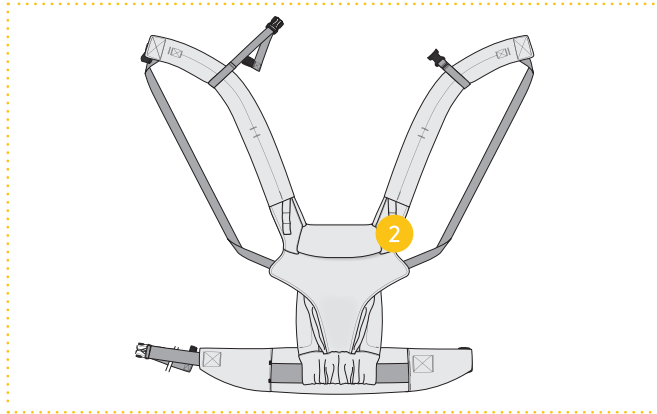

From the Front

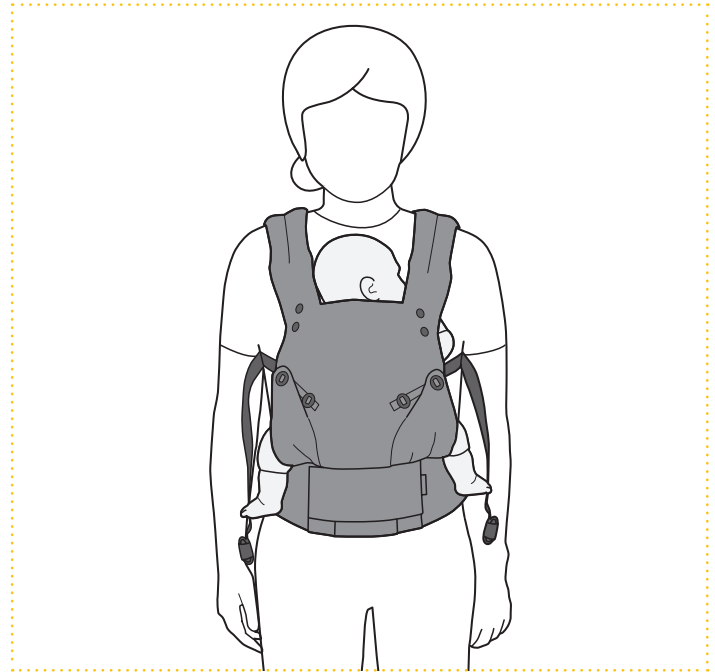



front carry – facing in

When wearing a baby from 0-2 months, make sure to prepare the carrier for Infant Mode before putting the carrier on. Please reference the “Infant Positioning” instructions for correct carrier set up. High support should always be buttoned onto the top most outer panel button when wearing a baby facing in.

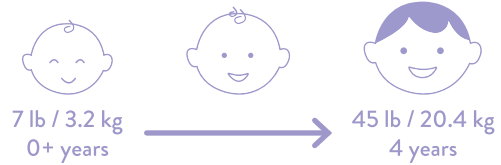

- 1 Position the waist belt so that the panel is centered on the front of your body.
- 2 Hold the baby so that they are positioned on your body with their legs in an “M” shaped position.
- 3 Use one hand to support the baby while using the other hand to smooth the panel up the baby’s back.
- 4 While supporting the child with one arm, slip the other arm into the strap.
- 5 Switch hands and slip the other arm into the other strap, making sure to keep one hand supporting baby until both straps are securely over your shoulders.
- 6 Buckle the shoulder strap connector by reaching behind your neck and clipping the buckle shut. Adjust to your comfort by tightening or loosening the shoulder strap connector webbing.
- 7 Adjust each shoulder strap by pulling forward on the adjustable webbing under the arms, tightening the straps for a snug fit...

...Continue to adjust one arm strap at a time until both you and your baby are comfortable. The panel should fit snugly around your baby, supporting their torso.

- 8 Ensure that the baby’s bottom is seated deeply in the panel just above the waist belt by gently pushing up on the baby’s calves. Baby should be seated in the “M” shaped position.
- ### How to Take Off Carrier
- 9 To take baby out of the carrier, loosen the straps under the arms. Do not unclip the waist belt until your baby is removed from the carrier.
 - 10 Lift up on one shoulder strap to bring the shoulder strap connector up towards the back of your neck. Unclip the shoulder strap connector with one hand while securing baby with the other hand.
 - 11 Remove the shoulder straps one at a time while always keeping one hand on the baby.

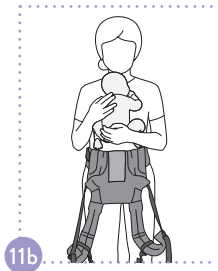
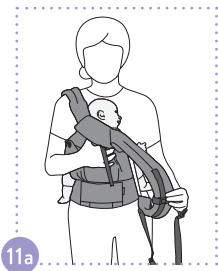
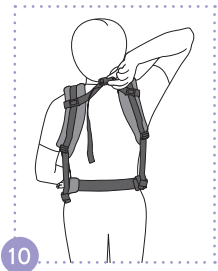
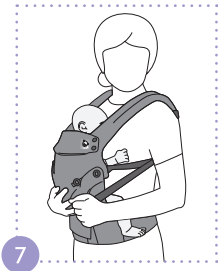
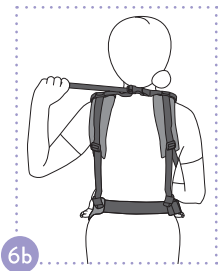
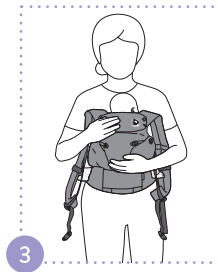
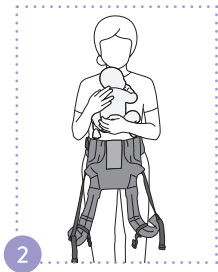
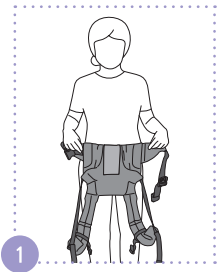

need more
help getting
the right fit?

Visit our YouTube channel
OR schedule a video fit check
with Team Tula at babytula.com





front carry – facing out



WARNING: Do not let baby sleep in facing-out position. Child's face must be towards you until he or she can hold head upright.

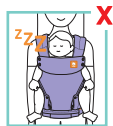

- 1 Position waist belt so that the panel is centered on front of your body.
- 2 Hold child to your chest, so they are facing outwards. Be sure to support their thighs. Use one hand to support them while using other hand to smooth the panel up the child's front. Neck support should be below child's chin. **Remember that neck support is always facing out when child is facing out.**
- 3 While supporting child with one arm, slip other arm into the strap.
- 4 Switch hands and slip the other arm into the other strap, making sure to keep one hand supporting child until both straps are securely over your shoulders.
- 5 Buckle the shoulder strap connector by reaching behind your neck and clipping the buckle shut. Adjust to your comfort by tightening or loosening the shoulder strap connector webbing.
- 6 Adjust each shoulder strap by pulling forward on the adjustable webbing under the arms, tightening the straps for a snug fit...

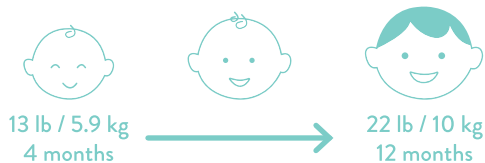

...Continue to adjust one arm strap at a time until both you and your baby are comfortable. Baby's arms should be positioned between the under-arm webbing and shoulder straps so they can move freely.

- 7 Ensure that baby is comfortably seated by pivoting their pelvis forward and pulling the seat under their thighs.

How to Take Off Carrier

- 8 To take baby out of the carrier, loosen the straps under the arms. Do not unclip the waist belt until your baby is removed from the carrier.
- 9 Lift up one shoulder strap to bring the shoulder strap connector up towards the back of your neck. Unclip the shoulder strap connector with one hand while securing baby with the other hand.
- 10 Remove the shoulder straps one at a time while always keeping one hand on the baby.

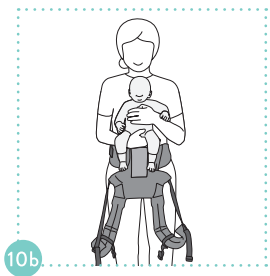
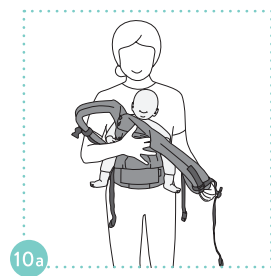
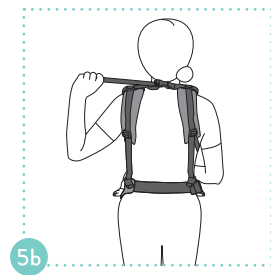
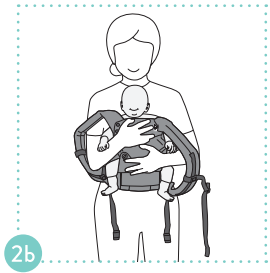
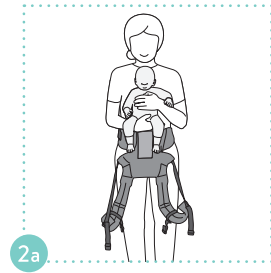

don't forget!

Follow us on social for all the latest Tula news





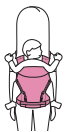



back carry instructions

Only use the back carry position when baby has strong and consistent head, neck, and torso control, and are able to sit unaided. The back carry can be used in either panel height and the middle or widest seat setting. This carrier is not intended for use in a back carry in the narrowest seat setting. Please have someone assist you until you feel comfortable putting your child in this position on your own. Thigh support should always be buttoned onto the top most outer panel button when wearing a baby on the back.

! **WARNING:** Do not use this position for babies without full neck, head, and torso control.

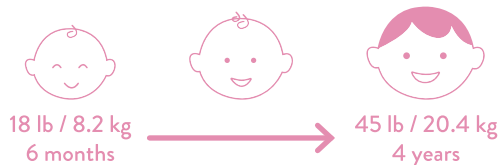
- 1 Position the waist belt so that the panel is centered on the back of your body.
- 2 Slip one of the straps over one arm.
- 3 Place your child on opposite hip.
- 4 Use the arm that is free from the strap to rotate your child from the hip position into the carrier while using the arm in the strap to secure your child. Lean forward slightly so the child's weight is resting on your back as you position them.
- 5 Smooth the panel up the child's back and slip your free arm through the second strap as though putting on a backpack strap, maintaining a slight forward lean.
- 6 Clip the shoulder strap connectors together in front of your chest and adjust to your comfort.



- 7 Ensure that the child's bottom is seated deeply in the panel just above the waist belt by standing up straight and pulling upwards by the shoulder straps while gently bouncing the child into the carrier to move the top of the panel higher up the child's back.
- 8 Adjust the carrier so that your child is comfortable and close to your body by pulling back on the adjustable straps under your arm for a snug fit around the leg openings and supporting the child's torso.
- 9 Gently push up on your child's calves so that the legs remain in the "M" position (see page 3).

How to Take Off Carrier

- 10 To take baby out of the carrier, lean forward slightly and loosen the straps under the arms. Unclip the shoulder strap connector with one hand while securing baby with other hand.
- 11 Remove the shoulder straps one at a time while always keeping one hand on the baby. Slide the baby around from your back to your hip.

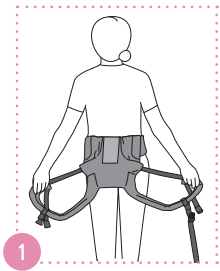

1

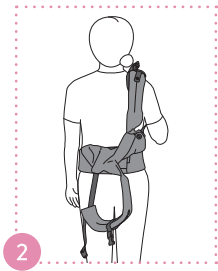

2



3

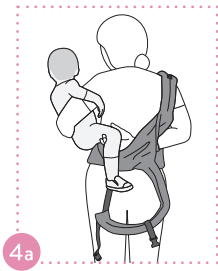

4a

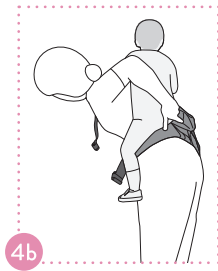

4b

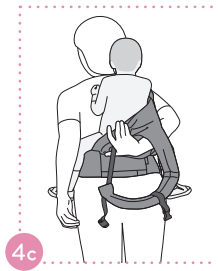

4c



5a



5b



6



7

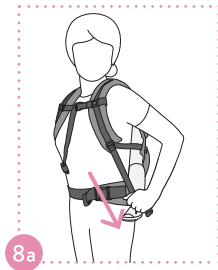

8a



8b



9a



9b



10

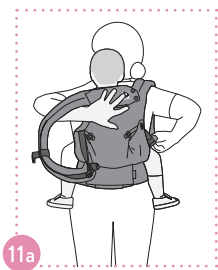

11a

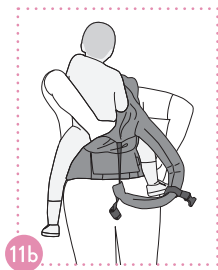

11b



11c

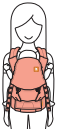

using the hood

Each Tula Explore Carrier comes with a detachable hood.

- 1 Attach the hood to the carrier by fastening the bottom of the hood to the snaps on the inside top of the carrier panel. To secure it in an “up” position, snap hood straps to the snap on the top of the shoulder straps.
- 2 The hood’s primary use is for supporting the head of an older baby if they fall asleep in a back carry. Please exercise caution while using the hood with smaller babies.
- 3 If you choose to use the hood to shield the sun from a smaller infant in a front carry, or to provide discretion while feeding, please attach the hood on only one side, leaving the other side down so that the baby’s face remains visible. Please ensure that the hood is not completely covering baby’s face to ensure that there is enough opening for air to pass through. Always check on your baby regularly.

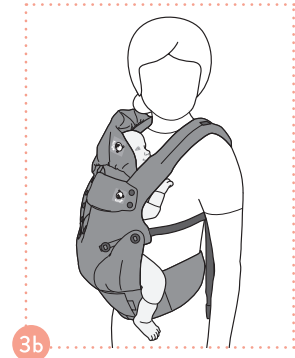
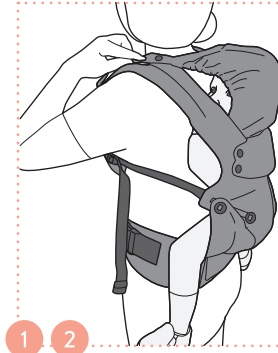

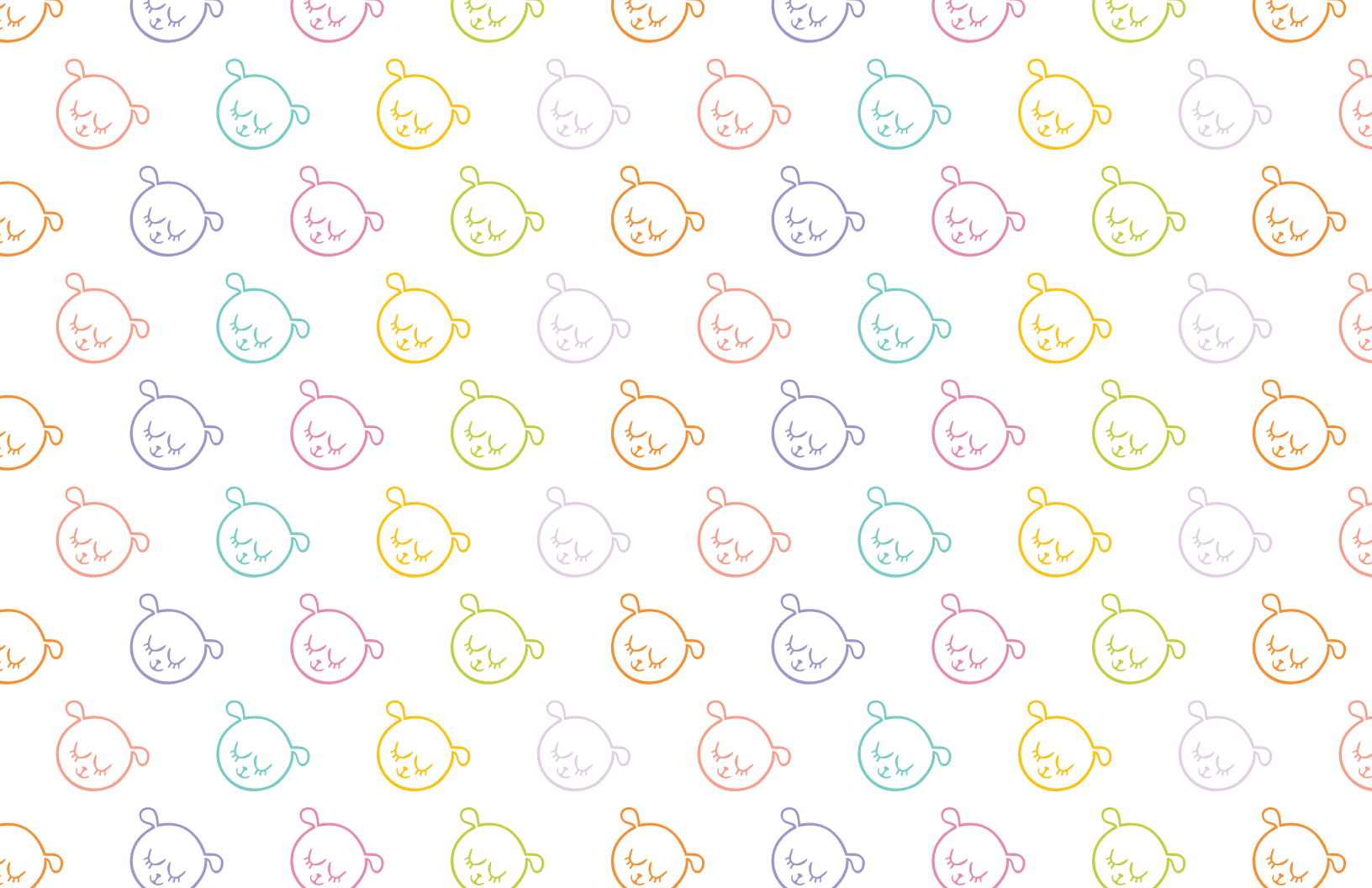

wash & care

Machine wash cold. Do not bleach. Line dry. Do not iron. Do not dry clean.

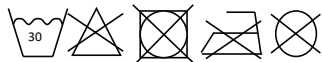

disclaimer

Baby Tula uses high-quality dyes to ensure a product will retain its color as much as possible. There is always a possibility that colors will fade with washing. Baby Tula cannot be held responsible for faded colors due to laundering.

Contact Baby Tula customer service for additional assistance if needed.

limited warranty

Baby Tula provides a limited warranty for its products against defects in materials and workmanship. We stand behind all our products and will either repair or replace, free of charge during the first year after purchase, any Baby Tula product that is defective.

limited warranty cont.

All carriers, including the Explore, Half Buckle, Free-to-Grow, Tula Baby/Toddler Carriers, Woven Wraps, Ring Slings, and Wrap Conversion Carriers have a one-year limited warranty against manufacturing flaws. In the rare instance in which there is a manufacturing issue or flaw, we will work with you to provide you with a refund, repair, or exchange. Our products are handmade and may have slight variations that do not affect their use or safety. Normal wear, fabric fading, minor size differences, common/normal wrap nubs or flaws, and sewing varieties are not considered manufacturing flaws and are not covered under the limited warranty. We are not responsible for warranty coverage if the product has been altered in any way. The term “altered” is defined as including, without limit, dyeing, painting, embroidery, and fabric additions or removals made after purchase. We are also not responsible for warranty coverage for any item that has been purchased secondhand. Proof of purchase is required for all returns or exchanges.

Should you have a warranty claim please contact Customer Service:
EU: help@babytula.eu
All other inquiries: help@babytula.com

Warranty Coverage does not extend to damage caused by misuse or any use of the Carrier that is not in accordance with the instructions stated in this manual. Warranty coverage does not extend to any Carrier that has been modified from its original construction in any way. Different or additional warranty rights may exist in the purchaser’s jurisdiction. To the extent that different or additional warranty rights exist under the laws of the purchaser’s jurisdiction, those warranties shall apply and be in addition to the warranty rights.



an expression of love



Baby Tula | **BabyTula.com** | help@babytula.com

US: 2640 Financial Ct. Suite E, San Diego, CA 92117 | 619.324.7563
PL: Komunalna 5, 15-197 Bialystok | +48.789.211.447