

Seamless Multi-view KVM Switch

USER MANUAL

ENJOY THE VIVID WORLD

Multi-view

Features :

- Using only 1 set of keyboard, mouse and monitor to control 4 computers
- No latency, support seamless switching
- Support resolution up to 1080P
- Support two working modes: KVM mode and synchronizer mode
- Support two display modes: full-screen display mode and multi-view display mode
- Support hot plug, connect or disconnect devices to the KVM switch at any time without turning off devices
- Support auto switching among all devices so as to monitor the devices in a specified time interval
- Support keyboard hotkeys, IR remote control, front panel buttons and mouse gesture to control the KVM to switch inputs
- With extra standard USB2.0 port, it is possible to connect barcode scanner, USB hard drive or other USB devices to KVM

Packing List :

- 1 * 4X1 HDMI KVM Switch
- 1 * DC 5V Power adapter
- 1 * IR Remote control
- 1 * User manual

Panel Description :

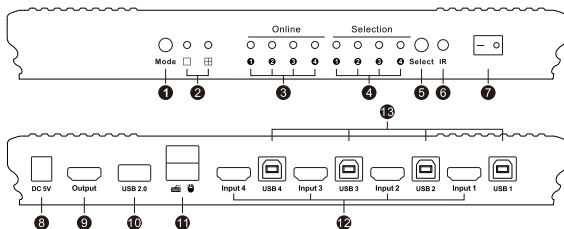

ID	Name	Description
1	Screen display mode and working mode selection button	(1) Press once, cyclically switch between full-screen mode and quad-view mode; (2) Keep pressing for 3~5 seconds, cyclically switch between synchronizer mode and KVM mode
2	Screen display mode status	Left-LED on: Full-screen mode Right-LED on: Quad-view mode
3	USB connection status	LEDs will be lit if the USB Type B ports connect to computers, and computers are on
4	Input selection status	Indicate current selected input source

Panel Description :

ID	Name	Description
5	Multi-function switching button	(1) In full-screen mode, switch audio, video, mouse and keyboard channels simultaneously; (2) In multi-screen mode, only switch audio, mouse and keyboard channels
6	IR receiver	Receive IR remote signal
7	Power switch	Turn on or turn off power supply
8	DC 5V	5V DC power supply
9	HDMI output	Connect to HDMI display
10	Standard USB 2.0 port	Connect to USB 2.0 devices, such as printers, USB drives
11	Keyboard and mouse input	Connect to keyboard and mouse
12	HDMI input	Connect to HDMI source devices
13	USB ports connected to PC	Connect to USB ports of PC

Connection Diagram :

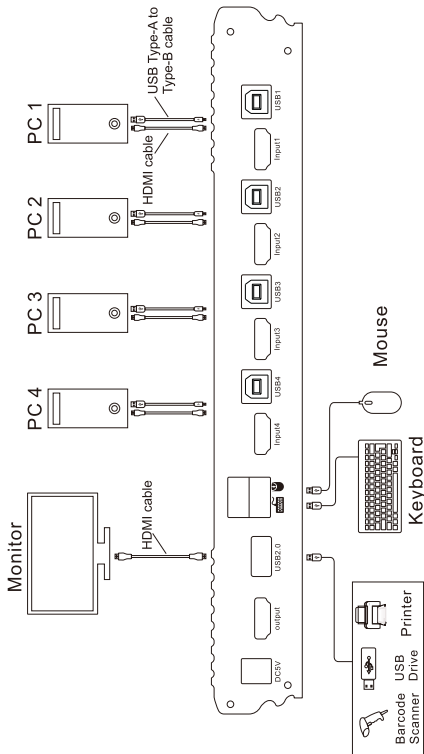

How To Use :

1. Set up the connection according to the connection diagram.
2. After all the PCs are started in step 1, then you can switch to any PC by keyboard hotkeys, IR signals or the buttons on the KVM front panel.

Note: The Multi-view KVM Switch supports two working modes.

1. KVM mode: A set of keyboard and mouse can only control one PC at a time.
2. Synchronizer mode: A set of keyboard and mouse can control four PCs simultaneously.

How To Use Keyboard Hot Keys :

1. Hit ScrollLock key twice within 2 seconds, the buzzer will beep twice.
2. After step 1, enter following hot key commands within 3 seconds, the KVM will execute the corresponding command.

 +  +  Cyclically switch between KVM mode and synchronizer mode



In full-screen mode, switch signal to next/previous input source;

In multi-view mode, just switch audio, mouse and keyboard channels to next/previous input source.



Select input port by number



Enable or disable buzzer sound





Enable or disable fast switching mode

If fast switching mode is available, then double hit left or right bound of the screen with mouse pointer in 1 second, KVM will switch to previous or next input







Turn on auto switching mode

Note: default auto switching time interval is 6 seconds, you are able to change this value by following hotkey commands:

 +
 
 +
 
 Increase or decrease auto switching time interval

Note: 1 second per step, the time is up to 250 seconds.

 Turn off fast switching mode and auto switching mode

 +
 
 +
 
 Switch to quad-view display mode

 +
 
 +
 
 Switch to other multi-view display modes

The following hotkeys are only available in synchronizer mode:

Keep pressing the key "Scroll Lock" or "***", then click the key you want to set to execute corresponding commands.



 +
 
 Turn on keyboard and mouse control of all input ports

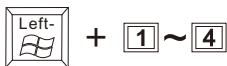

Turn on the keyboard and mouse control of the port corresponding to the number

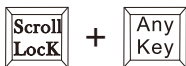

Turn off the keyboard and mouse control of the port corresponding to the number



Setup or cancel simulation of key press and key release

1. Press [Scroll Lock] + [A] and release, then if you keep pressing [A], the computer will receive key codes that [A] presses and [A] releases continuously. Up to 5 keys can be set to simulate this behavior.
2. If you want to cancel this simulation behavior, just press [Scroll Lock] + [A] and release. The behavior of pressing [A] will be reset.

Note: (1). This feature is used in some games to simplify the key clicking.
 (2). [Any Key] refers to character and number keys.

IR Remote control:

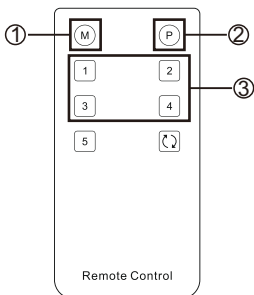

① – Cyclically switch between KVM mode and synchronizer mode

② – In full-screen mode, switch signal to next input

In multi-view mode, just switch audio, mouse and keyboard channels to next input

③ – Select input port by number

Note:1. For the safety request by some express company, the remote control is not equipped battery by default.

2. Unspecified buttons at above are non-functional.

Warranty Information :

We warrant this product as free of defects in material and workmanship for a period of one (1) year from the date of shipment.

If during the period of warranty this product proves defective under normal use, we will repair or replace this product, provided that this product has not been subjected to mechanical, electrical, or other abuse or modifications. If it fails under conditions other than those covered will be repaired at the current price of parts and labor in effect at the time of repair. Such repairs are warranted for six (6) months from the day of reshipment to the buyer.