

GUARDIAN Pool_NN SYSTEMS

INSTALLATION MANUAL

EN

HANDBUCH

DE

MANUAL DE INSTALACION

ES

MANUEL D'INSTALLATION

FR

MANUALE D'INSTALLAZIONE

IT

MANUAL DE INSTALAÇÃO

PT

MULTIPARAMETRIC FLUIDRA

GUARDIAN Pool_NN SYSTEMS

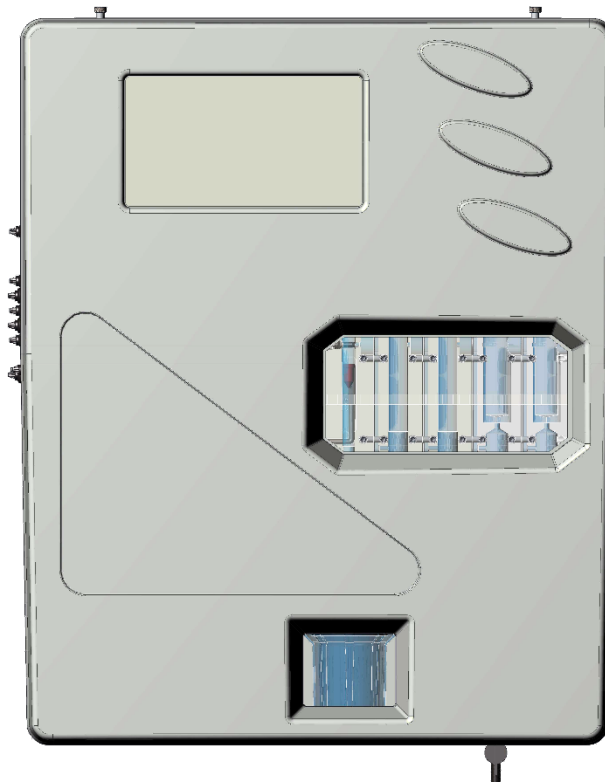

USER MANUAL

INDEX

1	GENERAL	4
1.1	LIMITS OF USE AND PRECAUTIONS FOR SAFETY	4
1.1.1	ELECTRICAL SAFETY	4
1.2	CAUTION SYMBOL	4
1.2.1	SPECIAL ATTENTION TO CRITICAL COMPONENTS	4
1.2.2	SAFETY OF THE OPERATIVE ENVIROMENT	5
1.3	MAIN TECHNICAL FEATURES	6
1.3.1	TECHNICAL FEATURES	7
2	GENERAL DESCRIPTION	8
3	PROGRAMMING	9
3.1	MAIN SCREEN	9
3.1.1	GENERAL SETTINGS	9
3.1.2	FACTORY SETTINGS	11
3.1.3	FLOW	11
3.1.4	WI-FI	12
3.1.5	DATA AND TIME	12
3.2	MEASURES	13
3.2.1	SET POINT	14
3.2.2	CALIBRATION	17
3.2.3	GRAPHICS	18
3.2.4	ALARM VALUES	18
3.2.5	MEASURE NAME	18
3.2.6	FIRST CALIBRATION	18
3.2.7	RANGE	18
4	INSTALLATION	19
4.1	INSTALLATION KIT	19
4.2	WALL MOUNTING	20
4.3	CONNECTION TERMINAL BLOCK	21
4.4	ELECTRICAL CONNECTIONS	24
4.5	HYDRAULICAL CONNECTIONS	24
4.6	PROBES CONNECTION	25
4.6.1	pH & REDOX PROBE CONNECTION	25
4.6.2	CONDUCTIVITY PROBE CONNECTION	25
4.6.3	CHLORINE PROBE CONNECTION	25
4.6.4	TEMPERATURE PROBE CONNECTION	26
5	STARTUP AND OPERATION	26
5.1	STARTUP	26
5.2	OPERATION	26
5.3	FLOW ADJUSTMENT	27
6	MAINTENANCE	28
6.1	GENERAL SYSTEM CLEANING	28
6.2	WATER FILTER CLEANING/REPLACEMENT	28
6.3	ELECTRODE/PROBE CLEANING	29
6.4	HYDRAULIC CIRCUIT INSPECTION	29
7	TROBLESHOOTING	30
8	APPENDIX	31
8.1	PLUS Version	31

8.2	FIRMWARE.....	32
8.3	MENU ADVANCED.....	32
8.4	MODBUS SLAVE ID	32
8.5	SERIAL NUMBER.....	32
8.6	RESET DEFAULT USER	32
8.7	CONNECTION TO FLUIDRA CONNECT	33

1 GENERAL

1.1 LIMITS OF USE AND PRECAUTIONS FOR SAFETY

In order to guarantee safety of the operator together with the correct functioning of the equipment, it is important to work within the limits permitted and to adopt all of the precautions listed below:

CAUTION



Check before use to make sure that all safety requirements are fully satisfied. The equipment must not be powered or connected to other equipment until safety conditions are satisfied.

1.1.1 ELECTRICAL SAFETY

CAUTION



All the connections should be isolated from the environment ground (mass is not isolated).

DO NOT connect any of these connections to earth.

In order to guarantee conditions of utmost safety for the operator, we recommend that all of the indications listed in this manual are respected.

- **Power the equipment exclusively using network tension according to specifications (100 ÷ 240 Vac/dc 50-60 Hz)**
- **Replace damaged parts immediately. Cables, connectors, accessories or other parts of the equipment that may be damaged or not working correctly must be replaced immediately. In this case contact your nearest authorized technical assistance center.**
- **According to UL, do not connect to relay outputs a voltage exceeding 115V**

1.2 CAUTION SYMBOL

The symbol illustrated below represents the **CAUTION** symbol and reminds the operator that he should read the user manual for important information, advice and suggestions for the correct and safe use of the equipment.

This symbol is also used within the software, in particular in the “measures” screen, putting attention to an event which will be explained in the following page of the screen.



In particular, when it is positioned close to connection points to cables and peripheries, the symbol in question refers to careful reading of the user manual for instructions related to the nature of such cables and peripheries and the methods for correct and safe connections.

The reproductions of equipment panels, with relative commands, connections, symbols and labels are provided in this chapter. Each caution symbol is accompanied by a detailed explanation of its meaning.

1.2.1 SPECIAL ATTENTION TO CRITICAL COMPONENTS

The instrument is fitted with an LCD liquid crystal display, which contains small amounts of toxic materials.

1.2.2 SAFETY OF THE OPERATIVE ENVIROMENT

The panel is protected against the introduction of liquids. Avoid subject the equipment to the risk of dripping water, sprays of water or immersion in water and the use in environments in which such risks may be present. Equipment in which liquids may have accidentally penetrated must be immediately switched off, cleaned and controlled by authorized and qualified personnel.

Once programming has been carried out, we recommend that the transparent panel is closed.

Protection:

- with a closed transparent panel IP65 EN60529
- with an open transparent panel IP54
- EMI /RFI CEI EN55011 - 05/99
- Use the equipment within the environmental limits of temperature, humidity and pressure specified.

The instrument has been developed to operate in the following environmental conditions:

- Temperature of the working environment: 0°C ÷ +50°C
- Temperature of storage and transportation: -10°C ÷ +50°C
- Relative humidity: 10% ÷ 95%RH – not condensing

CAUTION



The water treatment plant in which the instrument is introduced must be developed in accordance with the functional requirements imposed by current legislation.

The apparatus must be inserted perfectly into the plant.

The plant must be kept operative in full compliance with the safety regulations provided.

The parameters indicated on the control gear case of the analyzer must comply with current regulations.

Any signals of faults to the device must be positioned in an environment that is constantly controlled by operative personnel or plant assistants.

Non-compliance with even just one of these conditions may lead the “logics” of the device to operate in a potentially dangerous manner for users of the service.

Therefore, we recommend that service personnel and/or maintenance personnel operate with the utmost care, pointing out any changes to the safety parameters immediately, in order to avoid the creation of any potentially dangerous situations.

As the considerations indicated above cannot be controlled by the product in question, the manufacturer will not be held responsible for any damages that these malfunctions may cause to people or things.

1.3 MAIN TECHNICAL FEATURES

- Simultaneously measurement of: Free Chlorine, pH, Redox and Temperature (Optional: Total Chlorine, Combined Chlorine)
- **Programming:** through keyboard with 4 bubble keys
- LCD STN 240x128 backlighted
- Internal Data Logger Flash 4 Mbit storage equal to 16000 recordings with the possibility to visualize through tables and charts the measurement trend with the indication of minimum, maximum and average values of the period
 - **Recording interval:** 00:00 ÷ 99:99 min
 - **Type:** circular / filling
 - **Visualization:** table/chart
- **P.I.D. Regulation for pH Output**
- **RS485 Serial Output:** MODBUS RTU protocol with programmable velocity 1200 ÷ 38400 Baud Rate. for set-up, Real Time condition, or data download
- Nr.4 analogue outputs:
 - **Quantity:** ppm Cl₂, pH, Redox, Temperature.
 - **Typology:** 0.00 / 4.00 ÷ 20.00 mA galvanically isolated
 - **Limit programming:** lower / higher / Inversion
 - **Max load:** 500 Ohm
- Output alarm according to NAMUR 2.4 mA (with range 4/20mA)
- 2 Alarm Relay Output (lack of sample water, reagents exhaustion, burnt projector, dirty cell)
- 2 Relay Outputs of Set point 2 for Chlorine measurement
- 2 Relay Outputs of Set point 2 for pH measurement
- 1 Relay Output of Set point 2 for Redox measurement
- 1 Relay Outputs of Set point 2 for Temperature measurement (but also Total or Combined Chlorine on request)

Main hardware characteristics of the device

- The hardware structure of this periphery is based on the adoption of extremely new CPU CMOS with 16 bits developed specifically for the execution of the so-called "embedded" applications.
- The card uses an EEPROM to store the Set-up data and flash memories for storage of the archives of historical data and LOG files of events.
- The Card has 1 RS485 gate (opto-isolated) for local networks used for connections with local communication devices (configuration computer, terminals and remote controls etc).
- The card integrates a Real Time Clock (clock with date) that allows the software to store figures in a chronological order.

1.3.1 TECHNICAL FEATURES

Multiparameter power unit for the determination of:

Free Chlorine, Total Chlorine, pH, Redox, Temperature and Turbidity

Parameter	Range	Resolution	Accuracy
Free chlorine	00.00 ÷ 02.00ppm or 10.00ppm Cl ₂	0.01ppm	1% f.s.
Total chlorine	00.00 ÷ 10.00ppm Cl ₂	0.01ppm	1% f.s.
pH	00.00 ÷ 14.00 pH	0.01 pH	1% f.s.
Redox	±1000mV	1 mV	1% f.s.
Temperature	00.0 ÷ 65.0 °C	0.1°C	1% f.s.
Graphic display	TFT 7" Resistive touch backlighted. Simultaneous visualization of measurement values, digital outputs condition, storage condition, malfunctions. Touch programming		
Internal Data Logger	Flash 32 Mbit Recording interval: 00:00 ÷ 99:99 min Type: circular / filling Visualization: table/chart		
Nr.4 Analogue Outputs	ppm Cl ₂ , ppm Cl _{tot} , pH, Temperature Typology: 0.00 / 4.00 ÷ 20.00 mA galvanically isolated Limit programming: lower / higher / Inversion Max load: 500 Ohm P.I.D. Regulation		
Nr.5 Relay Outputs of Set Point	Nr. 2 for Chlorine + Nr. 2 for pH + 1 for Redox Set point with hysteresis: 00.00 ÷ 05.00 ppm Cl ₂ / 00.00 ÷ 14.00 pH / ± 1500 mV Programming of Hysteresis Relay max resistive load 6A at 250Vac		
Nr.2 Alarm Relay Output	ON-OFF cumulative for: Min/Max, set point Relays max resistive load 6A at 250Vac		
Digital Input	For flow sensor		
RS485 Serial Output	MODBUS RTU protocol with programmable velocity 1200 ÷ 38400 Baud Rate for set-up, Real Time condition or data download		
Operating conditions	Operational Temperature: 0÷50°C Storage and Transportation: -25÷65°C Humidity 10-95% not condensed		
Power Supply/ Electric Protection	Power supply: 90÷260Vac/dc 50-60Hz Average absorption: 30 W Electric protection:		
Housing	ABS Single plate housing		

2 GENERAL DESCRIPTION

The Guardian **Pool_NN** Panel series includes the following models:

Nr.	Model	Code	Description
1	Guardian Pool_NN 1 Free Chlorine 10 ppm	72700	-With sensor for organic chlorine ⁽²⁾ 0-10 ppm -Temperature
2	Guardian Pool_NN 2 Drinking water Free Chlorine 2 ppm	72701	-With sensor for organic chlorine ⁽²⁾ 0-2 ppm -Temperature
3	Guardian Pool_NN 3 pH and Free Chlorine	72702	- pH - Free organic chlorine ⁽²⁾ 0-10 ppm. - Temperature
4	Guardian Pool_NN 4 pH – ORP	72703	- pH - ORP sensor, in gold electrode (Sensorex) - Temperature
5	Guardian Pool_NN 5 pH – ORP – Free Chlorine	72704	- pH - ORP sensor, in gold electrode (Sensorex) - Free organic chlorine ⁽²⁾ - Temperature
6	Guardian Pool_NN 6 pH, ORP, Free Chlorine, Total Chlorine, Combined Chlorine. Input for NTU (4- 20mA)	72705	- pH - ORP sensor, in gold electrode (Sensorex), - Free Chlorine - Total Chlorine - Turbidity sensor - Temperature
7	Guardian Pool_NN 7 pH, Free Chlorine, Input for NTU (4- 20mA)	74720	- pH - Free Chlorine - Turbidity sensor - Temperature

NOTES:

(¹) In the ppm version, with conversion to **Bromide** (conversion factor 2,4) in the actual equipment, the customer can select read Chlorine or Bromide.

(²) This sensor can read **NaClO** (sodium hypochlorite), **Ca(ClO)₂** (calcium hypochlorite), **Cl₂** (chlorine gas), electrolytically generated chlorine, and organic combined chlorine based on iso-cyanuric acid (tested up to an iso-cyanuric acid concentration of 500 mg/l).

3 PROGRAMMING

This manual contains all the information for using the instrument screen. All the operative windows will be analyzed, with photos and explanation.

3.1 MAIN SCREEN

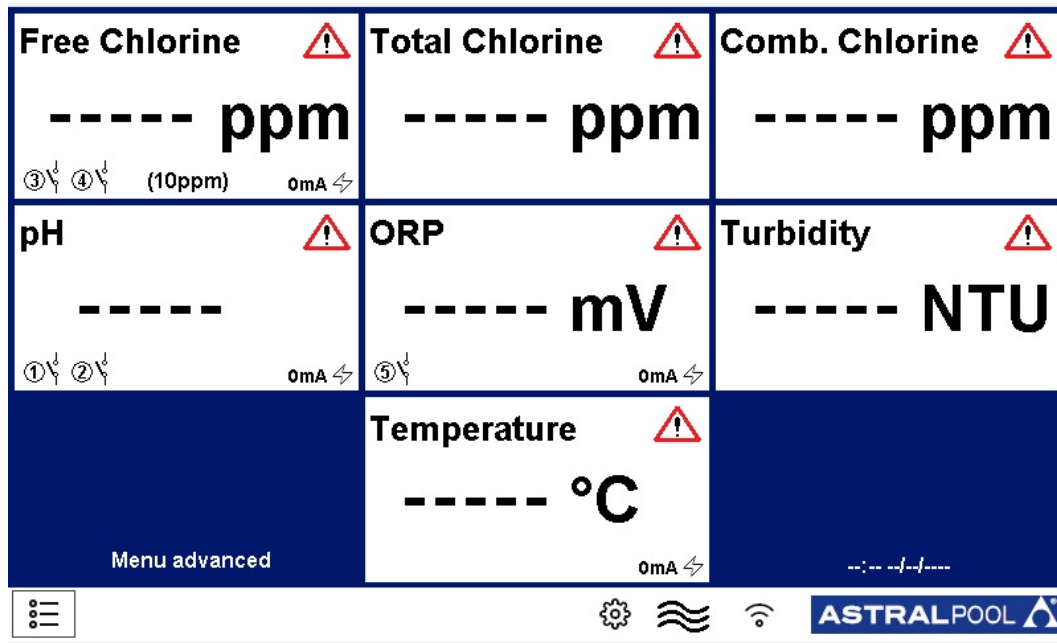

Figure 1 Main screen

3.1.1 GENERAL SETTINGS

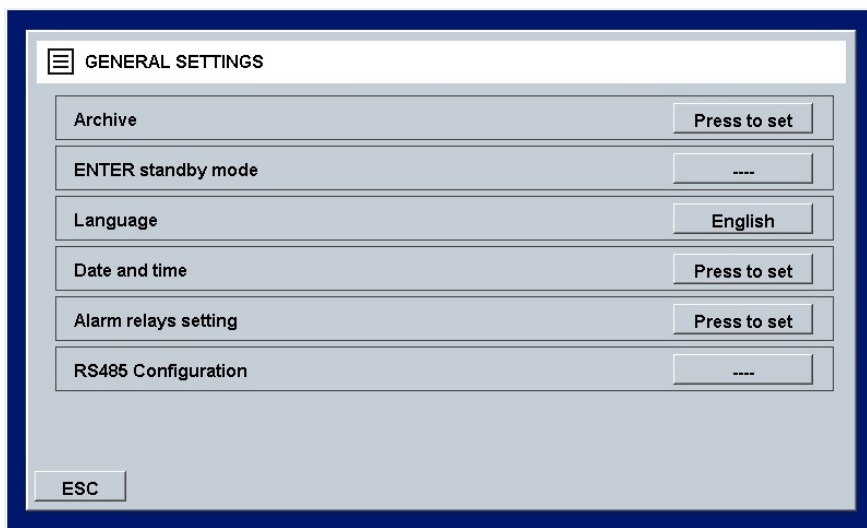

Figure 2 General setting

- **Archive:** how to save data
 - **STEP:** Choose every how often the system takes data (minutes).
 - **TYPE:** Decide the type of data archive:
 - **Circle:** It takes data in FIFO mode.
 - **Finite:** It takes data until is full. Then it requires to be empty.
 - **Reset:** Reset the saved data.
 - **Save on pen drive:** The system saves data on the USB port.
 - **View record:** It shows the archived data.
 - **Alarms Log:** It shows the alarm history.

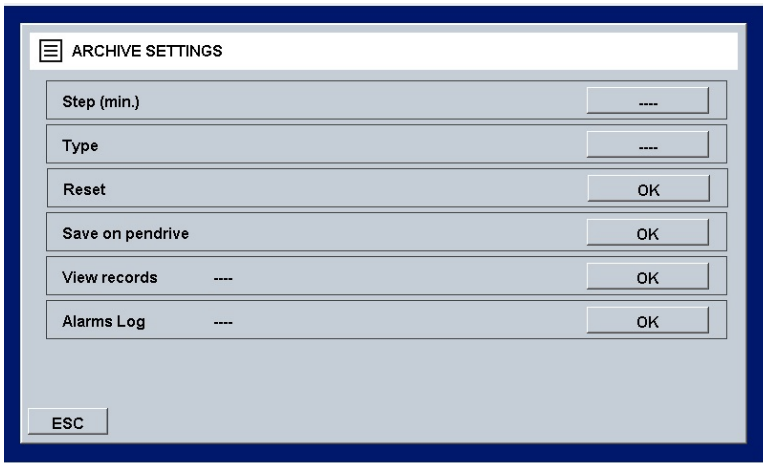

Figure 3 Archive settings

- **ENTER standby mode**
The system enters in standby, the system measures, but it does not perform dosages or commands.
- **Language**
Setting operative language (English).
- **Date and time:**
Setting date and time that it is visualized on the main window.

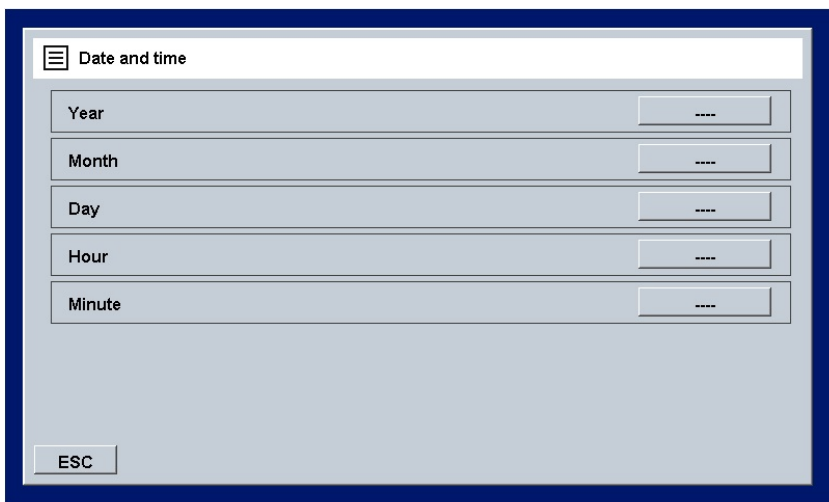

Figure 4 Date and time

- **Alarm relays setting**

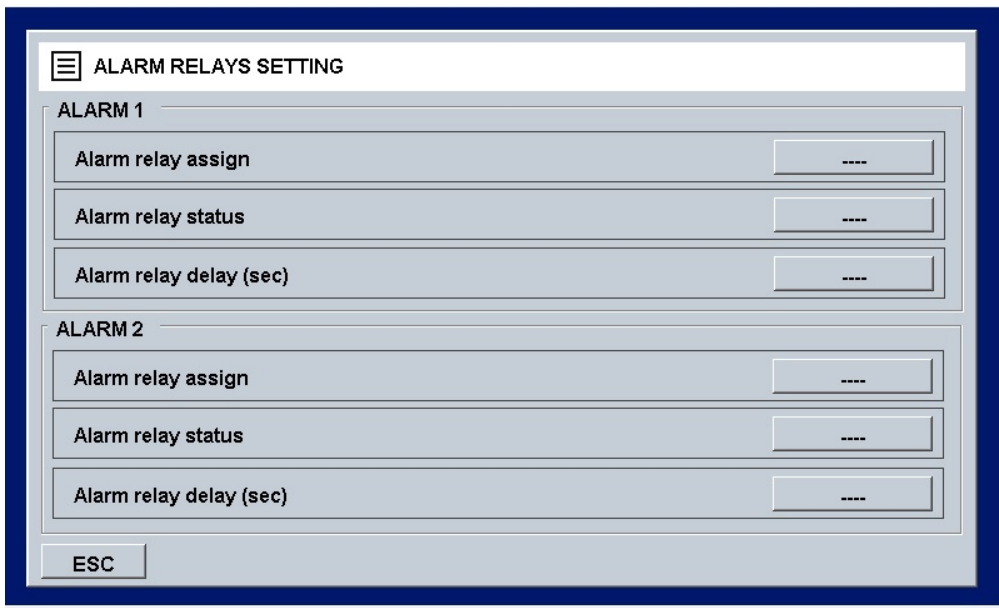

Figure 5 Date and time

There are two alarm relays and they are assignable:

- **ALARM RELAY ASSIGN:** Choose the measure at which to assign the relay; it is possible to choose between: all measures, Combine Chlorine Setpoint or Turbidity Setpoint.
- **ALARM RELAY STATUS:** It allows to choose the normal status of the relay:
NO (Normal Open)
NC (Normal Closed)
- **ALARM RELAY DELAY (SEC):** Choose the time (second) after which the relay changes its status.

3.1.2 FACTORY SETTINGS

This window is protected by password. The explanation is in the appendix.

3.1.3 FLOW

There's two states:

 - ON: when there is flow.

 - OFF: when there is not flow.

3.1.4 WI-FI

This icon shows if there is Wi-Fi LAN connection.

To connect to the Wi-Fi LAN network follow the steps below:

- 1) Connect to the wi-fi SSID-XXXX with a phone or PC; the network password is: **1234567890**
- 2) Start a browser and connect to the address: **192.168.4.1** and use the following data to login:
 - Username: **admin**
 - Password: **0000**
- 3) When connected, make sure that on the upper left side of the dashboard, next to the **Up since_** appears the date and time the card has been turned on

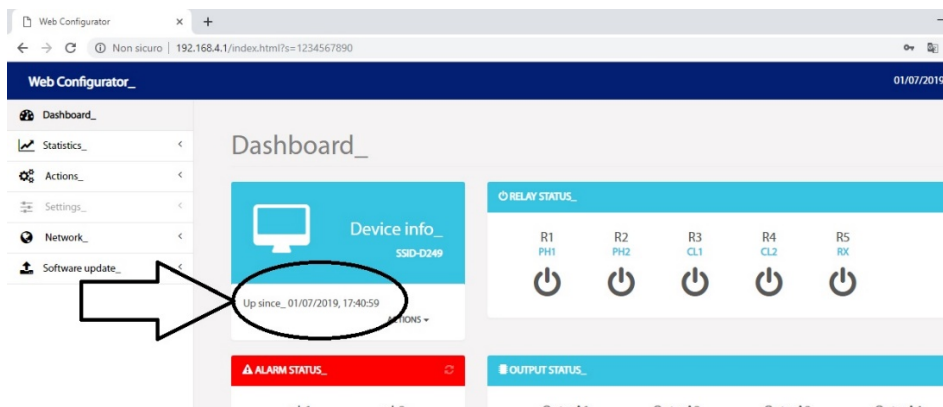

Figure 6 Setpoint menu

3.1.5 DATA AND TIME 10:00 03/05/2019

Shows the data and time that are setting in the menu window.

3.2 MEASURES

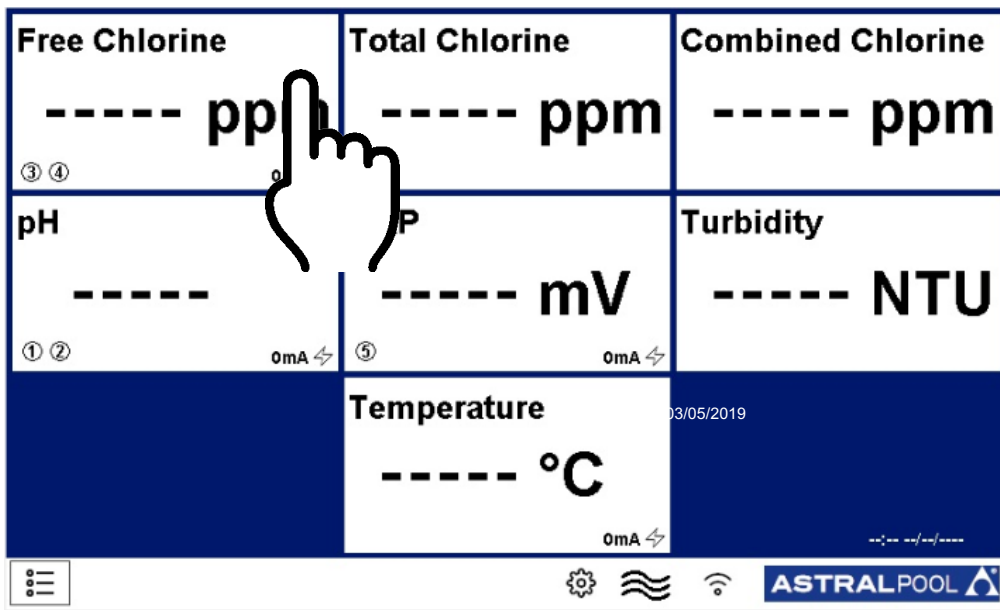

Figure 7 Main window

When you touch on the tab of the measure in the main window, it opens (Figure 7):

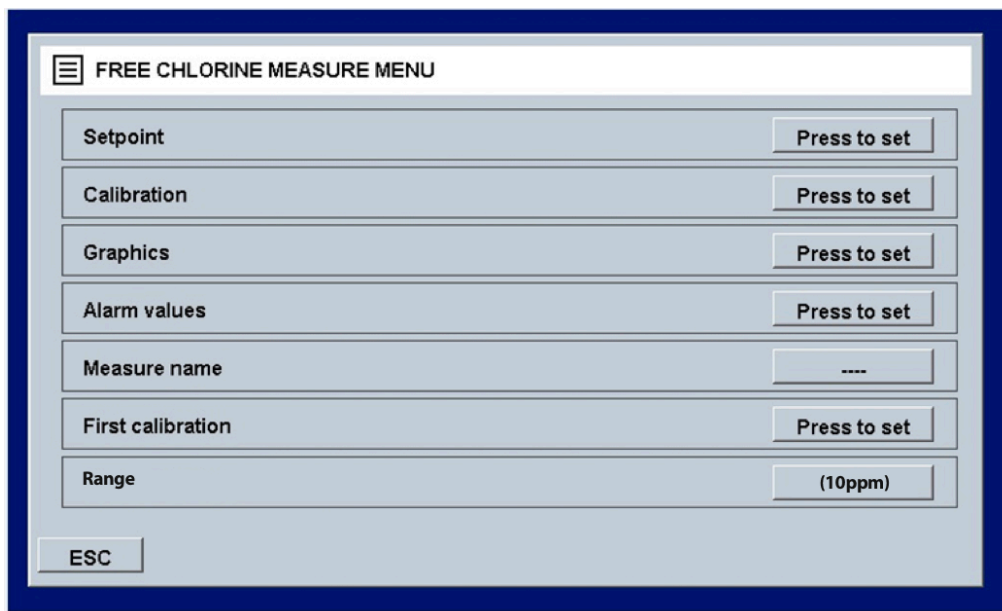
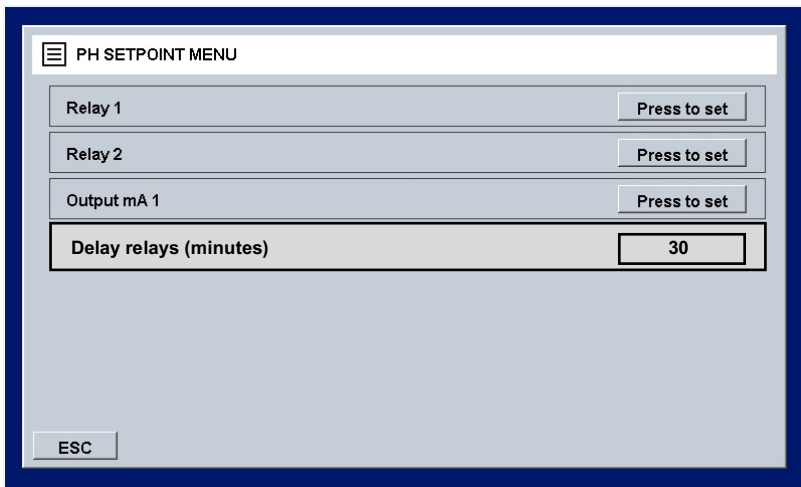

Figure 8 Measure menu

This window is the same for all measurements.

3.2.1 SET POINT



Note:

the "delay relays" menu only affects Relay 3 and 4 of the free chlorine, it is activated when the instrument is switched on, it has the function of waiting for a free chlorine probe polarization time, an hourglass is displayed on the main screen.



Figure 9 Setpoint menu

- **Relays**
 - The usable relay number is different for the measurements:
 - **Relay n° 1, 2 pH;**
 - **Relay n° 3, 4 Free Chlorine;**
 - **Relay n° 5 Rx;**

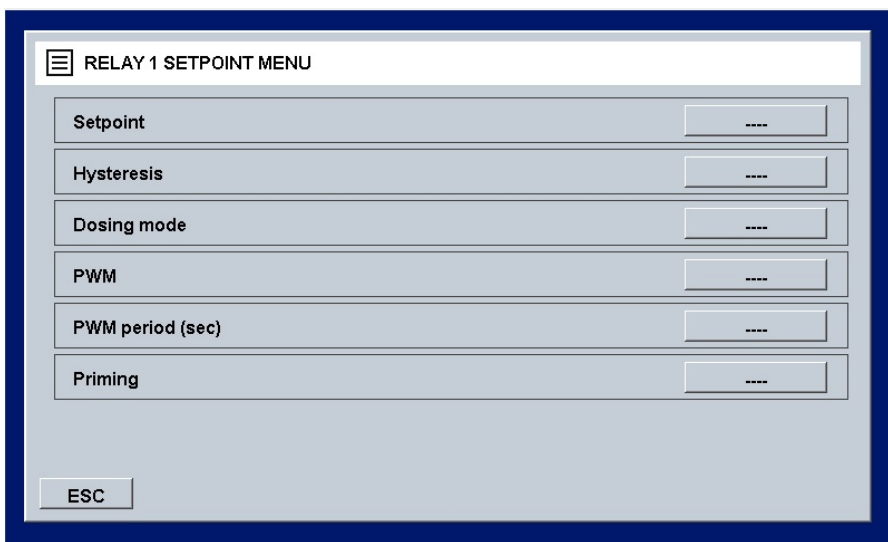

Figure 10 Relay setpoint menu

It is the windows deserved to relay:

SETPOINT: Set the value of the setpoint in ppm

HYSTERESIS: Set the range around the setpoint (setpoint \pm hysteresis is the range)

DOSING MODE: Set the Relay mode:

- HIGH: The Relay closes when the measures is lower of setpoint \pm hysteresis, and open when the measure is upper of setpoint \pm hysteresis

- LOW: The Relay open when the measures is lower of setpoint \pm hysteresis, and close when the measure is upper of setpoint \pm hysteresis

Priming: It is possible to active the dosing pumps related to the products by hand.

HIGH/LOW examples:

Dosing mode: HIGH

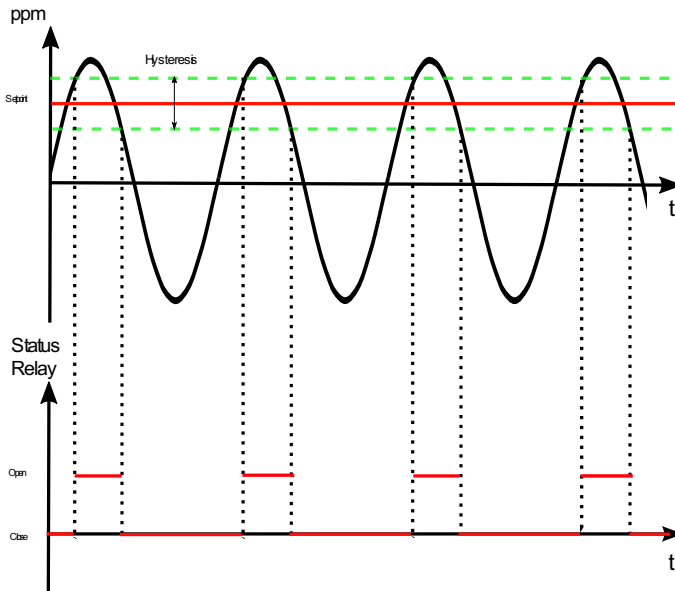

Figure 1 Relay setpoint menu

It is the choice to increase the measurement's value when it falls below a chosen value. The relay closes if the measurement's value is below the minimum of the range and it opens when it returns to the maximum of the range.

Dosing mode: LOW

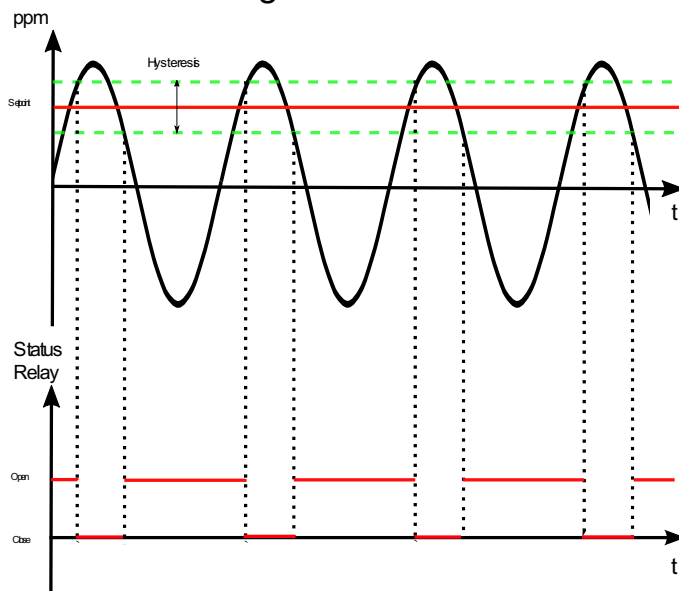

Figure 2 Relay setpoint menu

It is the choice to decrease the measurement's value when it rises above a chosen value. The relay closes when the measurement value is beyond the maximum of the range and it opens when it returns to the minimum of the range

- **OUTPUT mA**

The usable output mA number is different for the measurements:

- **Output mA 1 pH;**
- **Output mA 2 Free Chlorine;**
- **Output mA 3 Rx;**
- **Output mA 4 Temperature;**

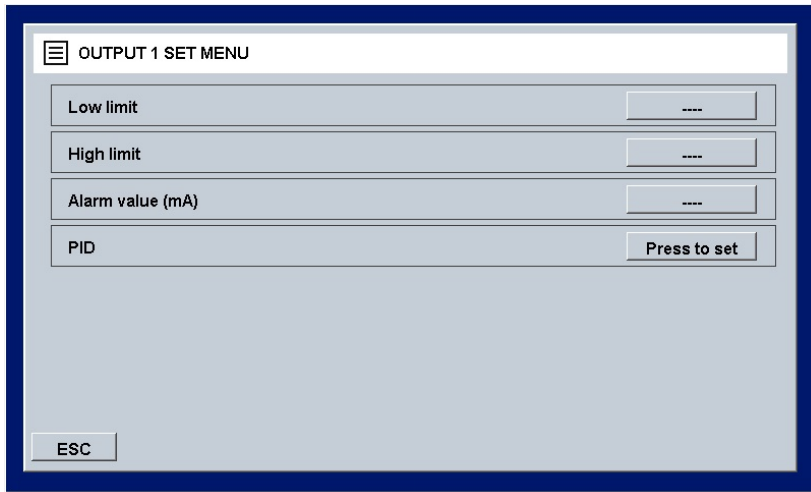

Figure 53 Output set menu

It is the window reserved to the output mA:

LOW limit: Set the minimum value of the output.

HIGH limit: Set the maximum value of the output.

Alarm value (mA): Set the value that if it is crossed generates an alarm.

PID: Press to open the window of the PID

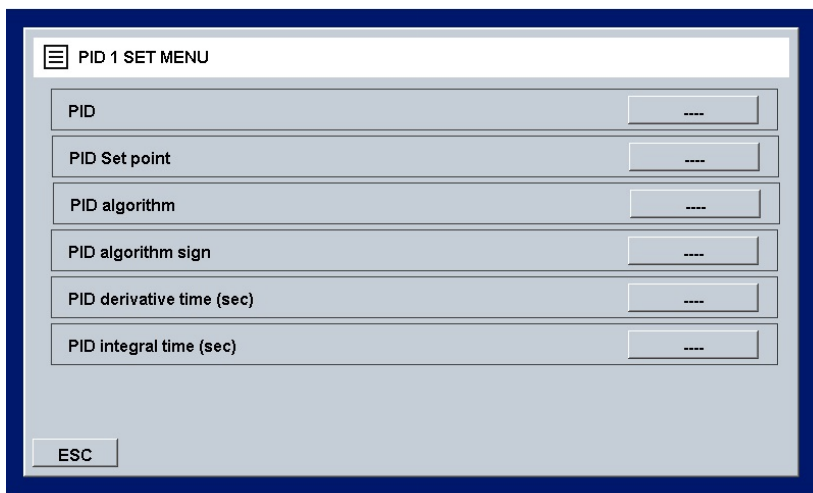

Figure 14 PID set menu

PID: Enabled PID on the output (ON/OFF).

PID Set point: Sets the set point of the PID.

PID algorithm: Sets which kind of PID (P/I/D).

PID algorithm sign: Sets the control type (Direct/Inverse).

- **Logic Max value / Logic Min. Value**

If the hysteresis is not present, the upper and lower limits can be set; if the measurement exceeds these values, an alarm is generated.

3.2.2 CALIBRATION

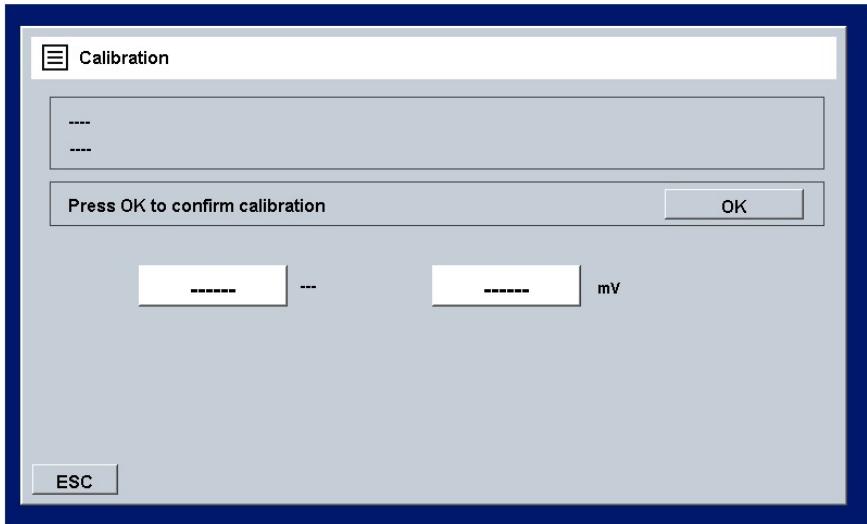

Figure 15 Calibration

This tab shows the calibration method for measurements; follow the instruction on the screen: Insert probe in the buffer, wait for measure to be stable (in the circled areas), and then press OK. It opens the follow window:

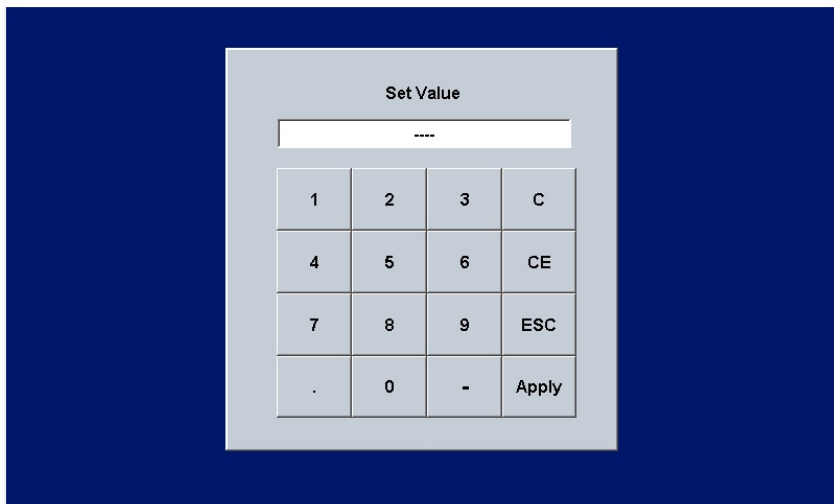

Figure 66 Set value

Set the buffer value and press OK.

Only the pH requires 2-point calibration (with 4 pH and 7 pH buffer solutions): When you press “Calibrate”, it opens the window of the other calibrations.

3.2.3 GRAPHICS

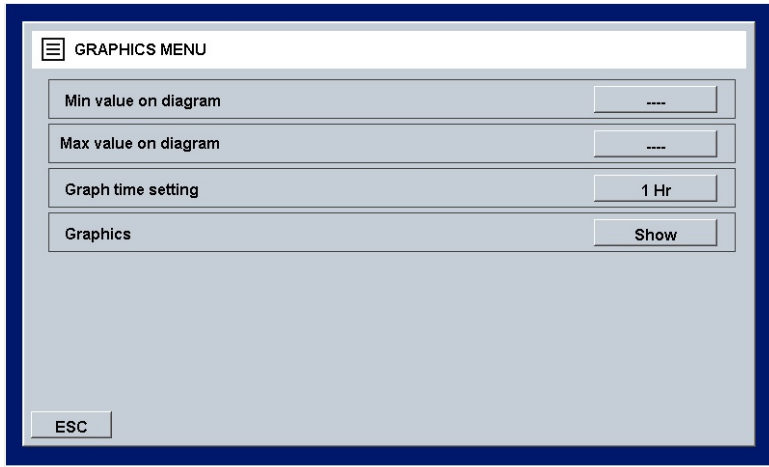

Figure 7 Graphics menu

- **Min value on diagram:** Set the min value on the graph
- **Max value on diagram:** Set the max value on the graph
- **Graph time setting:** Set the time axes
- **Graphics:** Press to visualized the graph (figure 18)

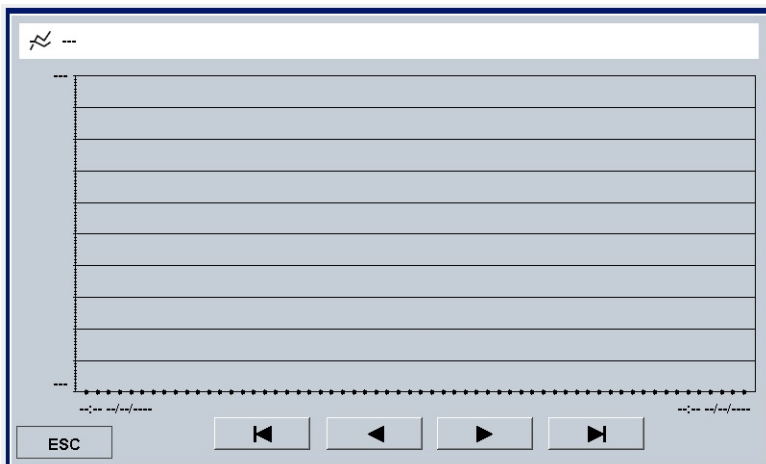

Figure 8 Graph

3.2.4 ALARM VALUES

Sets the max / min value above / below which activates the alarm

3.2.5 MEASURE NAME

It allows to modify the name of the measure in that tab

3.2.6 FIRST CALIBRATION

Perform the first calibration only after waiting 90 minutes

3.2.7 RANGE

Set the operating measure range of the probe.

4 INSTALLATION

Before installing the **AstralPOOL multi-parameter**, read the following carefully. This section describes the steps for installing the equipment and the electrical wiring. Follow these indications during installation.

- Make sure that the equipment and all related devices are turned off before starting work.
- If you encounter abnormalities or warning signals, stop immediately. Only start working again when you have removed the cause of the problem.
- Do not install the equipment in hazardous locations or in areas at risk of fire or explosion.
- Avoid electrical hazards. Never use damaged or defective equipment.

4.1 INSTALLATION KIT

	 1: Fixing screws (φ=6 mm screws)	 2: 8x12 PVC Crystal tube (4 m)	 3: Probe holder	 4: Connectors
	 5: 2 ppm Free Chlorine probe	 6: 10 ppm Free Chlorine probe	 7: 10 ppm Total Chlorine probe	 8: Cable for chlorine probe (1m)
	 9: pH probe	 10: Redox probe	 11: pH Buffer solutions	 12: ORP Buffer solution
 13: Filter Cartridge	 14: Backwash system	 15: PSS8 Turbidity probe holder	 16: Turbidity probe	 17: Temperature sensor
				 18: Conductivity probe and cable

N	Item	Pool_NN 1	Pool_NN 2	Pool_NN 3	Pool_NN 4	Pool_NN 5	Pool_NN 6	Pool_NN 7
	Product Code	72700	72701	72702	72703	72704	72705	74720
1	Fixing screws	•	•	•	•	•	•	•
2	8x12 PVC Tube 4 meters	•	•	•	•	•	•	•
3	Probe holder	•	•	•	•	•	•	•
4	Connectors	•	•	•	•	•	•	•
5	2 ppm Free Chlorine Probe		•					
6	10 ppm Free Chlorine Probe	•		•		•	•	•
7	10 ppm Total Chlorine Probe						•	
8	Chlorine Cable 1 meter	•(x1)	•(x1)	•(x1)		•(x1)	•(x2)	•(x1)
9	pH Probe			•	•	•	•	•
10	Redox Probe				•	•	•	
11	pH7 and 4pH Buffer solution			•	•	•	•	•
12	465 mV Redox Buffer solution				•	•	•	
13	80µm Cartridge filter	•	•	•	•	•	•	•
14	Backwash system	(*1)	(*1)	(*1)	(*1)	(*1)	(*1)	(*1)
15	PSS8 Turbidity Probe Holder						•	
16	Turbidity Probe						•	
17	Temperature Probe	•	•	•	•	•	•	•
18	Conductivity Probe and Cable	(*1)	(*1)	(*1)	(*1)	(*1)	(*1)	(*1)

(*1 on demand).

4.2 WALL MOUNTING

Install the control unit away from heat sources, in a dry place, without splashing water and protected from dripping, at temperatures below 40°C. The minimum temperature must not fall below 0°C.

The control unit must be installed, making sure to leave enough space for the cables and connections.

The rear panel of the control unit is provided with 4 holes near the corners for mounting the unit to the wall. The figure below features the position of the drilling holes and the maximum dimensions of the panel.

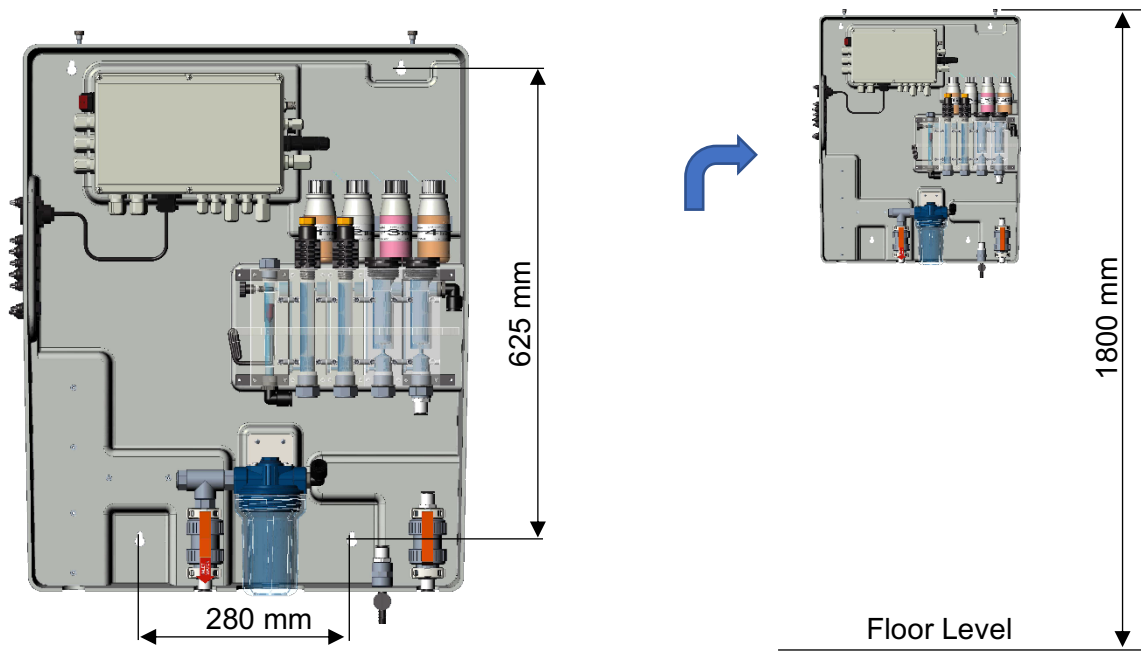

Figure 9 System wall mounting

If adequate for the support, use the wall plugs supplied, otherwise choose a suitable type. The unit is supplied already assembled and wired internally.

To ensure optimal support for the system, the wall must be as straight and even as possible.

Drill two holes horizontally aligned at a height that enables the operator to have a correct view of the control panel and a suitable position for the calibration and control operations.

The recommended height from the floor is about 180 cm or at least at eye level.

The distance between the holes is indicated on the picture above.

Use a spirit level during installation to correctly level the control unit.

The overall enclosure dimensions are: 730x600x230 mm (H x L x D)

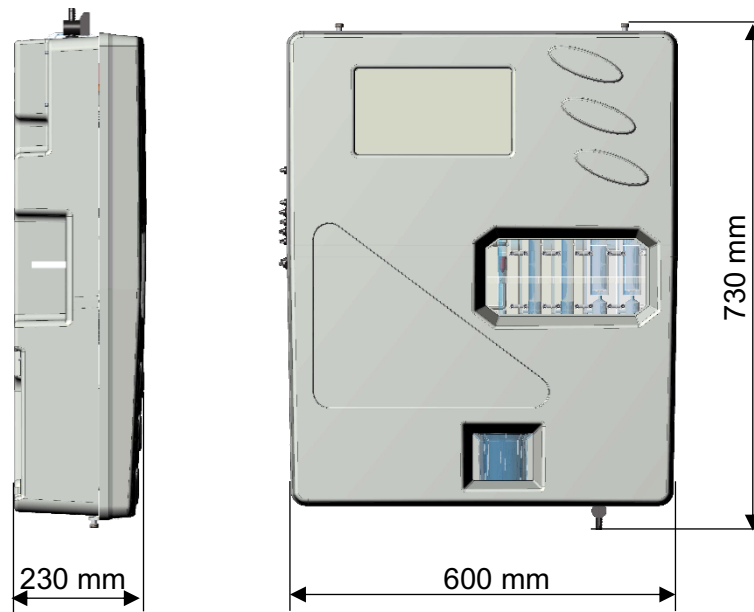

Figure 10 System dimensions

4.3 CONNECTION TERMINAL BLOCK

Before installing the Astralpool multiparameter, read the following carefully

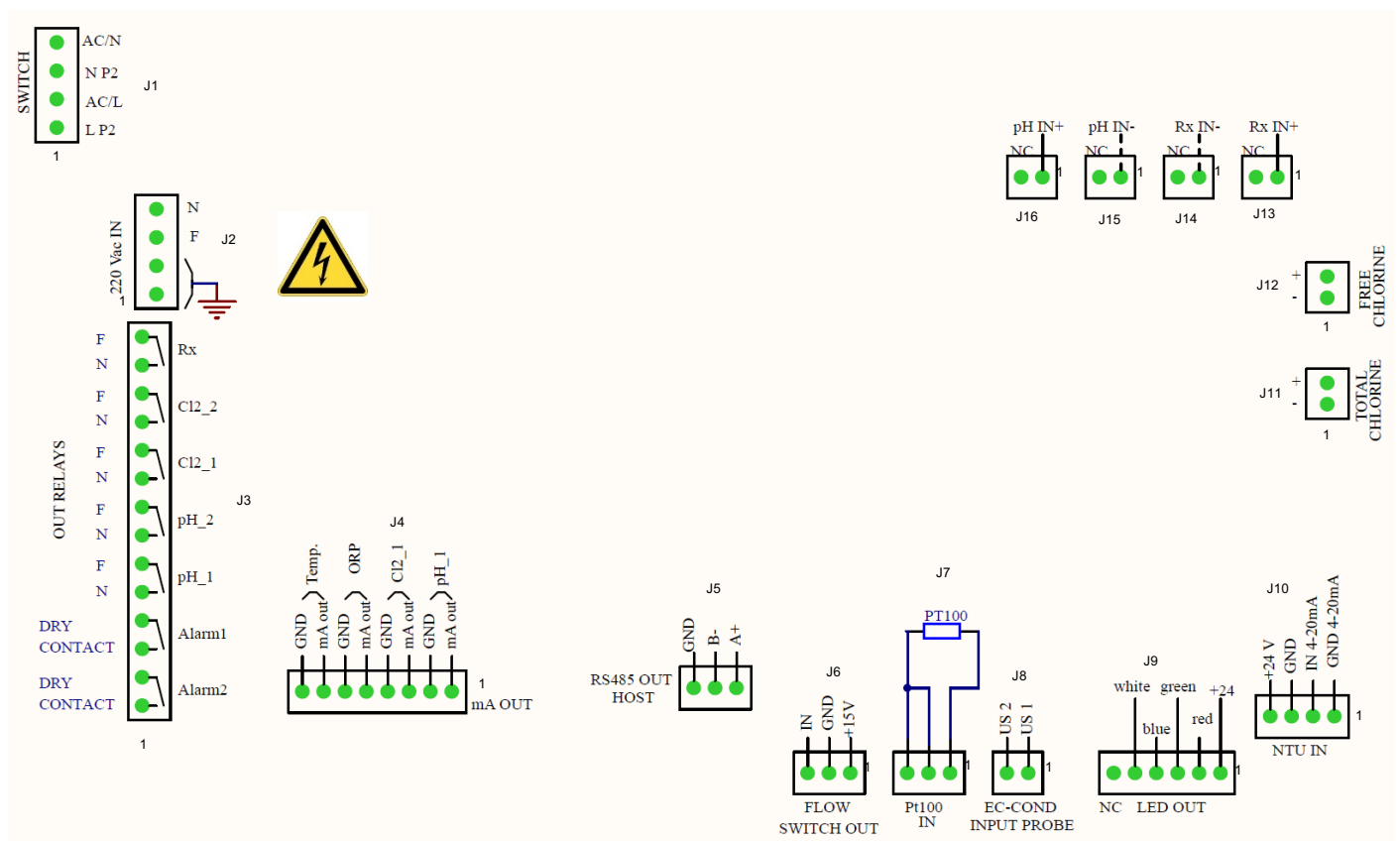
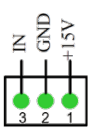

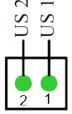
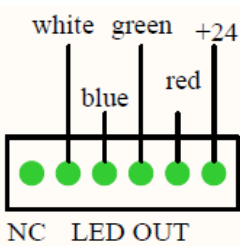
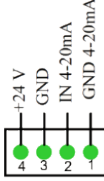







Figure 11 Connections

Connector	Terminal	PICTURE	DESCRIPTION	
J1	1		AC power supply neutral cable	
	2		220 Vac neutral cable	
	3		AC power supply line cable	
	4		220 Vac line cable	
J2	1		Ground cable 1	
	2		Ground cable 2	
	3		220 Vac power supply line cable	
	4		220 Vac power supply neutral cable	
J3	1	ALARM 2 	Remote alarm (2) relay	dry contact
	2		Remote alarm (2) relay	
	3	ALARM 1 	Remote alarm (1) relay	dry contact
	4		Remote alarm (1) relay	
	5	pH_1 	pH set point 1	powered contact (100-240Vac)
	6		pH set point 1	
	7	pH_2 	pH set point 2	powered contact (100-240Vac)
	8		pH set point 2	
	9	Cl2_1 	Cl ₂ set point 1	powered contact (100-240Vac)
	10		Cl ₂ set point 1	
	11	Cl2_2 	Cl ₂ set point 2	powered contact (100-240Vac)
	12		Cl ₂ set point 2	
	13	Rx 	Rx set point	powered contact (100-240Vac)
	14		Rx set point	
J4	1	pH_1 	mA pH positive cable	
	2		mA pH negative cable	
	3	Cl2_1 	mA Cl ₂ (1) positive cable	
	4		mA Cl ₂ (1) negative cable	
	5	ORP 	mA ORP positive cable	
	6		mA ORP negative cable	
	7	Temp 	mA Temperature positive cable	
	8		mA Temperature negative cable	
J5	1		RS485 interface (A+)	
	2		RS485 interface (B-)	
	3		RS485 interface (Ground)	

(* ¹ The Alarm relay is settable at: Alarm All measure, Comb. CL Setpoint; Turbidity Setpoint)

Connector	Terminal	PICTURE	DESCRIPTION	
J6	1		+15 V cable	
	2		Ground cable	
	3		IN cable	
J7	1		PT 100 connection cable	
	2		PT 100 connection cable	
	3		PT 100 connection cable	
J8	1		EC-Cond probe	μS cable 1
	2			μS cable 2
J9	1		+24V	
	2		Red	
	3		Green	
	4		Blu	
	5		White	
	6		NC	
J10	1		Turbidity probe	4-20 mA (Ground)
	2			4-20 mA (IN)
	3			Power supply 24 V-
	4			Power supply 24 V+
J11	1		Total Chlorine probe	Cl _{tot} negative cable
	2			Cl _{tot} positive cable
J12	1		Free Chlorine probe	Cl ₂ negative cable
	2			Cl ₂ positive cable
J13	1		ORP probe	RG 174 Rx (IN +)
	2			
J14	1		ORP probe	RG 174 Rx (IN -)
	2			
J15	1		pH probe	RG 174 pH (IN -)
	2			
J16	1		pH probe	RG 174 pH (IN +)
	2			

4.4 ELECTRICAL CONNECTIONS

Terminal Block connections:

N	Item	Function	Pool_NN 1	Pool_NN 2	Pool_NN 3	Pool_NN 4	Pool_NN 5	Pool_NN 6	Pool_NN 7
	Code		72700	72701	72702	72703	72704	72705	74720
1	100-240Vac 50-60Hz	Power Supply	•	•	•	•	•	•	•
2	Relay1 (pH1)	Dose action powered			•	•	•	•	•
3	Relay2 (pH2)	Dose action powered			•	•	•	•	•
4	Relay3 (CL1)	Dose action powered	•	•	•		•	•	•
5	Relay4 (CL2)	Dose action powered	•	•	•		•	•	•
6	Relay5 (Rx)	Dose action powered				•	•	•	
7	Relay6 (Alr1)	Alarm Status dry contact	•	•	•	•	•	•	•
8	Relay7 (Alr2)	Alarm Status dry contact	•	•	•	•	•	•	•
9	mA1 (pH)	Output mA			•	•	•	•	•
10	mA2 (Cl)	Output mA	•	•	•		•	•	•
11	mA3 (Rx)	Output mA				•	•	•	
12	mA4 (°C)	Output mA	•	•	•	•	•	•	•
13	RS485 Serial port	Communication	•	•	•	•	•	•	•
14	Reed Input	Flow status input	•	•	•	•	•	•	•
15	pH probe	Input mV signal			•	•	•	•	•
16	CL probe1	Input mA signal	•	•	•		•	•	•
17	CL probe2	Input mA signal						•	
18	Turbidity probe	Input mA signal						•	•
19	Rx probe	Input mV signal				•	•	•	
20	Temp. probe	Input Ohm signal	•	•	•	•	•	•	•
21	5 VDC output	Power supply for Led light	•	•	•	•	•	•	•
22	Wi-Fi Connection	Wi-Fi Connection	•	•	•	•	•	•	•
23	Conductivity Probe	Input mV signal	•	•	•	•	•	•	•

4.5 HYDRAULICAL CONNECTIONS

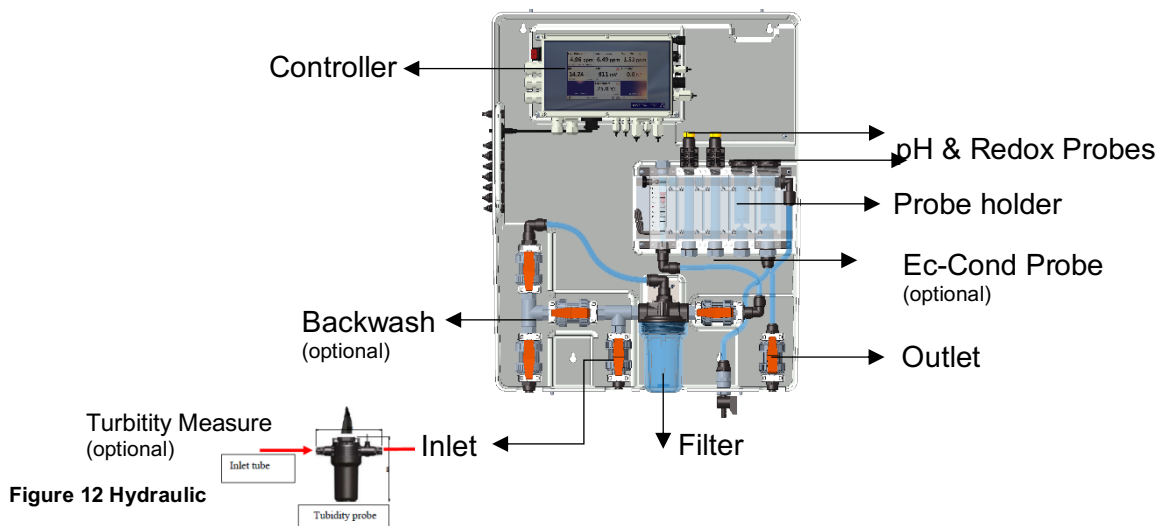

4.6 PROBES CONNECTION

4.6.1 pH & REDOX PROBE CONNECTION



pH probe connector

Redox probe connector

Figure 13 pH and Redox connectors

4.6.2 CONDUCTIVITY PROBE CONNECTION

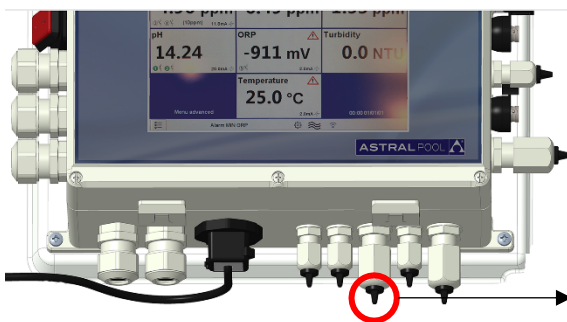

Conductivity probe connector
(optional probe)

Figure 14 Conductivity connector

4.6.3 CHLORINE PROBE CONNECTION



Free and Total Chlorine
probe connectors

(Note: please, check the label connections with chlorine probes polarity connection)

Figure 15 Chlorine connectors

4.6.4 TEMPERATURE PROBE CONNECTION

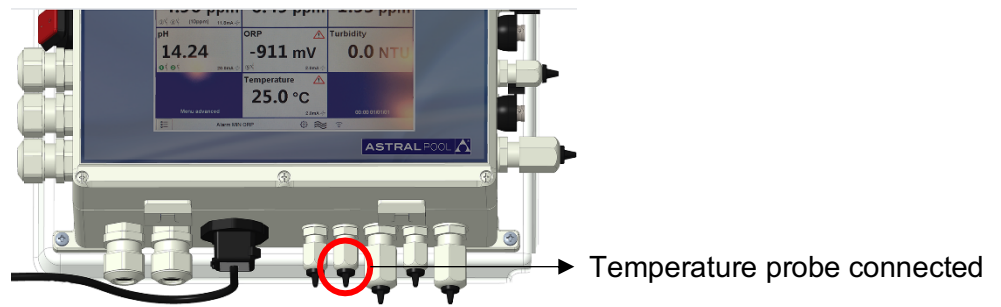

Figure 16 Temperature connector

5 STARTUP AND OPERATION

5.1 STARTUP

Power up the system using the Power Switch on the upper left side of the controller.

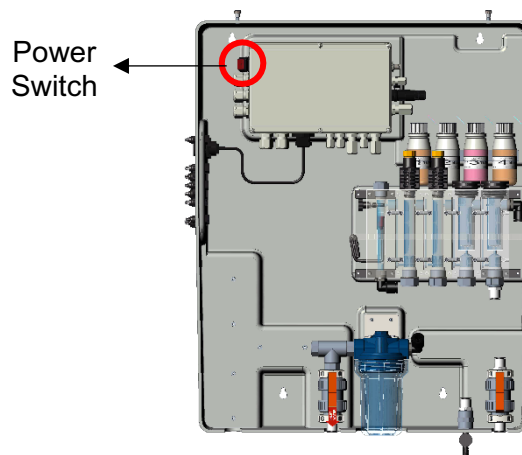
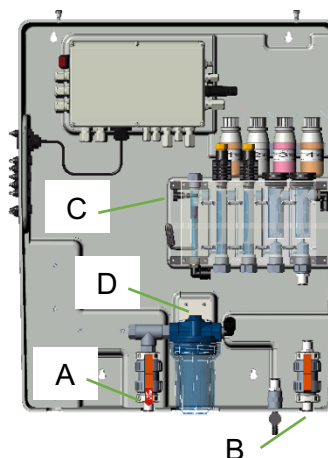

Figure 17 Power switch

5.2 OPERATION

- A: Connect Inlet tube
- B: Connect Outlet tube
- C: Open completely the flow regulation
- D: Degassing filter air



5.3 FLOW ADJUSTMENT

The water flow must be adjusted using the valve indicated in the figure below

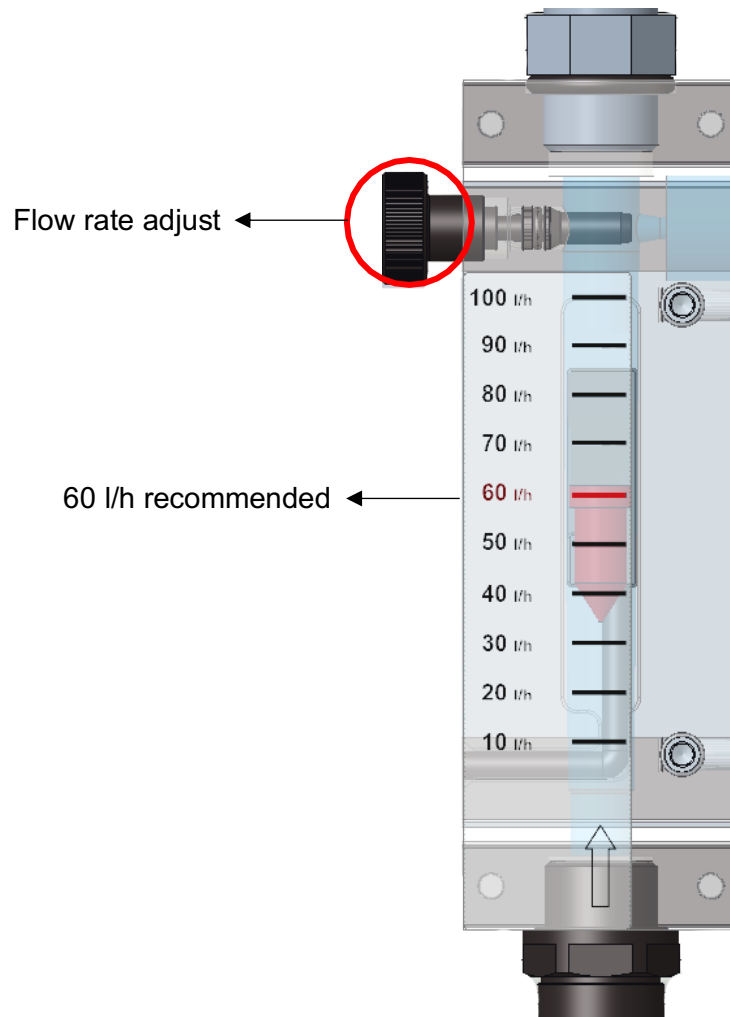

Figure 18 Flow rate faucet

6 MAINTENANCE

In order to always ensure optimal performance of the equipment, it must be serviced regularly. We also recommend following our maintenance programs.

Below you can find an indication of the maximum maintenance intervals:

Maintenance operation	TIME INTERVALS			
	1 month	2 months	3 months	6 months
General system cleaning				X
Water filter mesh cleaning	X			
Hydraulic circuit inspection		X		
Probe cleaning	According to the electrode/probe instruction manual.			

CAUTION



Before carrying out any maintenance operation, switch the equipment off electrically by pressing the main switch of the line where the same is located.

CAUTION



Before carrying out any maintenance operations, stop the flow of water that reaches the equipment from the system and depressurise by fully opening the sampling valve.

6.1 GENERAL SYSTEM CLEANING

Perform this operation once a month.

Clean all the equipment surfaces regularly. Only use a damp cloth without adding any solvent or product.

6.2 WATER FILTER CLEANING/REPLACEMENT

Perform this operation every two months.

Wait until there is no more water coming out of the hydraulic circuit.

Unscrew the filter unit tray and remove the filter cartridge from inside; be careful not to lose the gaskets. Place the cartridge under running water and remove all the debris from the filter using a soft brush. Remount the filter cartridge and the filter tray on the system, being careful to put the gaskets back in place properly.

Fully close the sampling valve and restore the water flow in the circuit, opening the valves gradually and releasing the air from the system. Reactivate the system electrically and check the operating conditions after it has run the initial test.

6.3 ELECTRODE/PROBE CLEANING

Refer to the electrode/probe instruction manual before performing this operation.

Wait until there is no more water coming out of the hydraulic circuit. Disconnect the electrode cables by unscrewing the connectors at their ends and the fastening clamps, then remove them from the probe holder in the hydraulic circuit of the system. Wash the sensitive end with warm water and mild soap, removing any residual grease using a paintbrush with soft bristles.

To clean the probes do not rub them with abrasive objects or cloths that can charge them electrostatically.

In the event of extreme dirt, clean the electrodes using Denatured Alcohol. When the cleaning operations are complete, reconnect the electrodes with their respective cables and calibrate them without restoring the water flow to the system. When the calibration procedure is complete, switch the system off electrically and replace the electrodes in the probe holder. Reconnect the power supply and the water flow to the system after closing the sampling valve.

6.4 HYDRAULIC CIRCUIT INSPECTION

Perform this operation every six months.

Visually inspect the hydraulic circuit of the equipment after switching it off electrically. In the presence of leaking liquid, pipe damage or any sealing problem, act on the hydraulic circuit only after having interrupted the flow of water reaching the station and depressurize the system by opening the sampling valve.

Replace the damaged parts with original or recommended spare parts only.

CAUTION



Do not leave impurities inside the hydraulic circuit that may clog it.

CAUTION



Close the sampling valve before reconnecting the water flow to the system. Restore the system pressure by proceeding gradually and then power the equipment.

7 TROUBLESHOOTING

Mechanical faults	
The flow inside the measurement cell is too low	<ul style="list-style-type: none"> Check the seal of the o-rings Check if the filter is clogged Check the inlet and outlet valves Check the sampling valve
Electrical faults	
No luminous signal, display switched off	Check that the equipment is powered correctly (socket and plug). If the equipment remains inactive, please contact our Service Centre
Incorrect measurements	<ul style="list-style-type: none"> Check the calibration carefully, if in doubt, reset the instrument with its default factory settings Check that the probes are working properly and check their state of wear

Sometimes liquid may leak from a loose connection or ring nut, or simply due to the rupture of the water supply tube. When the leak has been eliminated, you must clean and dry any residual water on the system, which could damage the parts in contact by stagnating.

8 APPENDIX

BE CAREFUL



This TAB is protected by password. It is reported in this manual only for information.

APPENDIX 1 - FACTORY SETTINGS

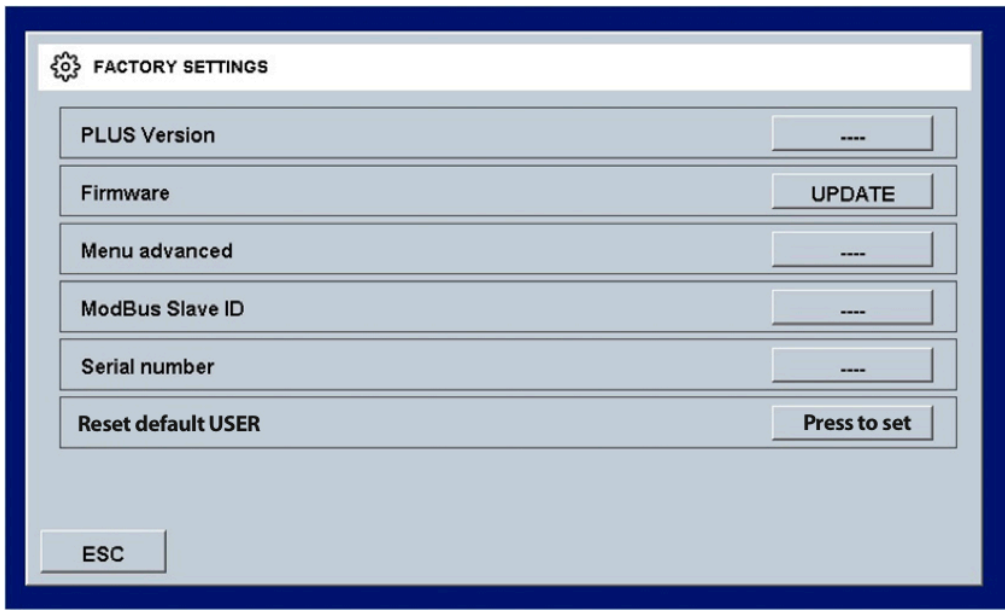

Figure 19 Factory Settings

8.1 PLUS VERSION

It allows to select the type of version you want to get:

- PLUS 1 (Guardian NN 1): Free Chlorine 10 ppm and Temperature
- PLUS 2 (Guardian NN 2): Free Chlorine 2 ppm and Temperature
- PLUS 3 (Guardian NN 3): Free Chlorine 10ppm , pH and Temperature
- PLUS 4 (Guardian NN 4): pH, Redox and Temperature
- PLUS 5 (Guardian NN 5): Free Chlorine, pH, Redox and Temperature
- PLUS 6 (Guardian NN 6): Free/Total/Combine Chlorine, pH, Redox, Turbidity and Temperature
- PLUS 7 (Guardian NN 7): Free Chlorine, pH, Turbidity and Temperature

8.2 FIRMWARE

It allows to update the firmware: the firmware file must be in a USB pen, that must be inserted before pushing OK on the TAB "Press OK to Start"

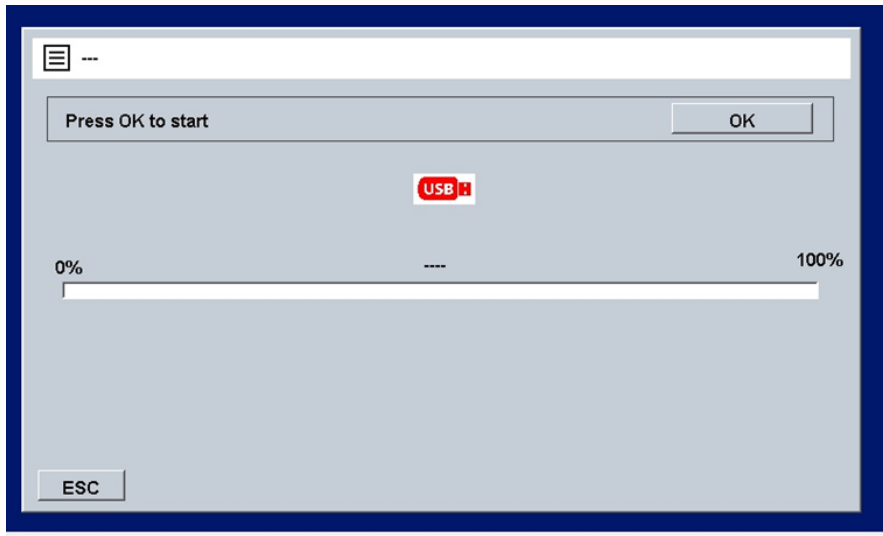

Figure 30 Firmware update

8.3 MENU ADVANCED

It allows to set the advanced mode, unlocking some hidden menu of standard mode (ON/OFF)

8.4 MODBUS SLAVE ID

It allows to modify the slave ID, inserting a new one (ID=1 default)

8.5 SERIAL NUMBER

It allows to modify the serial number of the instrument

8.6 RESET DEFAULT USER

It allows to reset all parameters and restore the factory settings.

8.7 CONNECTION TO FLUIDRA CONNECT

Connection to Connect & Go control cabinet

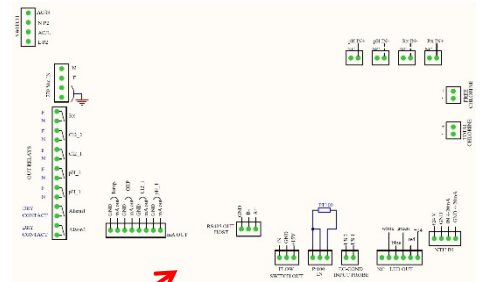
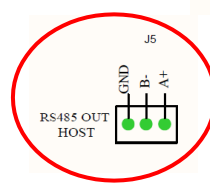
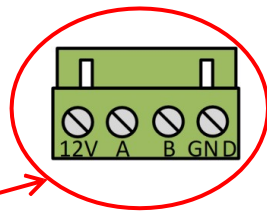

Connections:

Connect & Go	12V	A	B	GND
Guardian Pool	Not used	A+	B-	GND

Connection to Connect Box

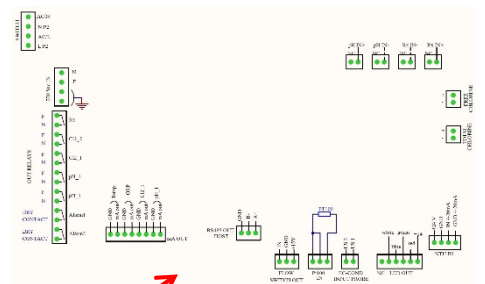
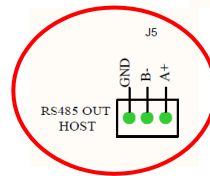
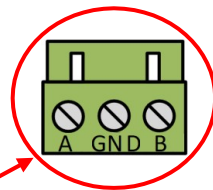
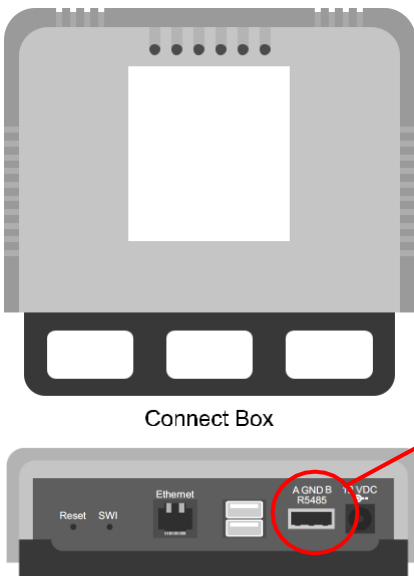

Connections:

Connect Box	A	B	GND
Guardian Pool	A+	B-	GND

MULTIPARAMETRIC FLUIDRA

GUARDIAN Pool_NN SYSTEMS

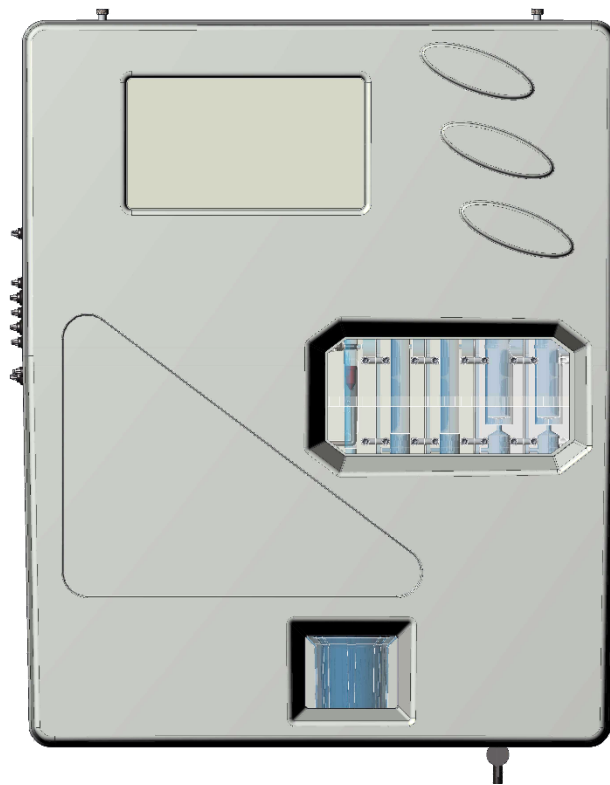

BEDIENERHANDBUCH

INHALT

1	ALLGEMEINES	4
1.1	EINSATZGRENZEN UND SICHERHEITSVORKEHRUNGEN	4
1.1.1	ELEKTRISCHE SICHERHEIT	4
1.2	VORSICHTSSYMBOL	4
1.2.1	BESONDERE VORSICHT BEI KRITISCHEN BAUTEILEN.....	5
1.2.2	SICHERHEIT DER BETRIEBSUMGEBUNG	5
1.3	WESENTLICHE TECHNISCHE EIGENSCHAFTEN	6
1.3.1	TECHNISCHE EIGENSCHAFTEN	7
2	ALLGEMEINE BESCHREIBUNG	8
3	PROGRAMMIERUNG	9
3.1	HAUPTBILDSCHIRM	9
3.1.1	ALLGEMEINE EINSTELLUNGEN	9
3.1.2	WERKSEINSTELLUNGEN	11
3.1.3	DURCHFLUSS	11
3.1.4	WI-FI.....	12
3.1.5	DATUM UND UHRZEIT	12
3.2	MESSUNGEN	13
3.2.1	SOLLWERT	14
3.2.2	KALIBRIERUNG	17
3.2.3	GRAFIKEN	18
3.2.4	ALARMWERTE.....	18
3.2.5	NAME MESSUNG.....	18
3.2.6	ERSTE KALIBRIERUNG.....	18
3.2.7	BEREICH.....	18
4	INSTALLATION	19
4.1	INSTALLATIONS-BAUSATZ	19
4.2	WANDMONTAGE	20
4.3	ANSCHLUSSKLEMMENBLOCK	21
4.4	ELEKTRISCHE ANSCHLÜSSE	24
4.5	HYDRAULISCHE ANSCHLÜSSE	25
4.6	ANSCHLUSS DER SONDEN	26
4.6.1	pH- & REDOX-SONDE ANSCHLUSS	26
4.6.2	ANSCHLUSS DER LEITFÄHIGKEITSSONDE	26
4.6.3	ANSCHLUSS DER CHLORSONDE	26
4.6.4	ANSCHLUSS DES TEMPERATURFÜHLERS.....	26
5	INBETRIEBNAHME UND BETRIEB	27
5.1	INBETRIEBNAHME	27
5.2	BETRIEB	27
5.3	DURCHFLUSSREGULIERUNG	28
6	WARTUNG	29
6.1	ALLGEMEINE SYSTEMREINIGUNG	29
6.2	WASSERFILTER REINIGEN /AUSWECHSELN	29
6.3	REINIGUNG DER ELEKTRODE/SONDE	30
6.4	ÜBERPRÜFUNG DES HYDRAULIKKREISES	30
7	FEHLERBEHEBUNG	31
8	ANHANG	32
8.1	PLUS-Version	32

8.2	FIRMWARE.....	33
8.3	ERWEITERTES MENÜ.....	33
8.4	MODBUS SLAVE ID	33
8.5	SERIENNUMMER	33
8.6	STANDARDNUTZER ZURÜCKSETZEN	33
8.7	VERBINDUNG ZU FLUIDRA CONNECT.....	34

1 ALLGEMEINES

1.1 EINSATZGRENZEN UND SICHERHEITSVORKEHRUNGEN

Um die Sicherheit des Bedieners zusammen mit einem ordnungsgemäßen Betrieb der Ausrüstung zu gewährleisten, ist es wichtig, innerhalb der zulässigen Grenzen zu arbeiten und sämtliche nachstehend aufgelisteten Vorkehrungen anzuwenden:

VORSICHT



Vor dem Gebrauch überprüfen, um sicherzustellen, dass alle Sicherheitsanforderungen umfassend erfüllt sind. Das Gerät darf nicht mit Strom versorgt oder an andere Geräte angeschlossen werden, solange die Sicherheitsbedingungen nicht erfüllt sind.

1.1.1 ELEKTRISCHE SICHERHEIT

VORSICHT



Alle Anschlüsse müssen von der Umgebungserde isoliert sein (Masse ist nicht isoliert). KEINEN dieser Anschlüsse mit der Erde verbinden.

Um größtmögliche Sicherheit für die Bedienperson zu gewährleisten, empfehlen wir, alle Hinweise in dieser Anleitung zu befolgen.

- **Das Gerät ausschließlich mit einer Netzspannung gemäß den Spezifikationen (100 ÷ 240 Vac/dc 50-60 Hz) versorgen**
- **Beschädigte Teile umgehend ersetzen. Kabel, Anschlüsse, Zubehör oder andere Geräteteile, die beschädigt sind oder nicht richtig funktionieren, müssen sofort ersetzt werden. Wenden Sie sich in diesen Fällen bitte an eine zugelassene Kundendienststelle in Ihrer Nähe.**
- **Gemäß UL darf an die Relaisausgänge keine Spannung angeschlossen werden, die 115 V übersteigt**

1.2 VORSICHTSSYMBOL

Das Symbol unten ist das **VORSICHT**-Symbol. Es erinnert die Bedienperson daran, dass sie für wichtige Informationen, Empfehlungen und Hinweise zum korrekten und sicheren Gebrauch die Bedienungsanleitung des Gerätes lesen sollte.

Dieses Symbol wird auch innerhalb der Software verwendet, insbesondere im Bildschirm "Maßnahmen", um auf ein Ereignis aufmerksam zu machen, das auf der folgenden Seite des Bildschirms erläutert wird.



Wenn das entsprechende Symbol in der Nähe von Anschlusspunkten zu Kabeln und Peripheriegeräten angebracht ist, bezieht es sich auf das sorgfältige Lesen der Bedienungsanleitung für Hinweise zur Art dieser Kabel und Peripheriegeräte und der Vorgehensweise für den korrekten und sicheren Anschluss.

Dieses Kapitel enthält Abbildungen der Bedienfelder des Geräts und der entsprechenden Steuerelemente, Anschlüsse, Symbole und Beschriftungen. Zu jedem Vorsichtssymbol gibt es eine genaue Erklärung seiner Bedeutung.

1.2.1 BESONDERE VORSICHT BEI KRITISCHEN BAUTEILEN

Das Gerät ist mit einem Flüssigkristall-Display (LCD) ausgestattet, das geringe Mengen an toxischen Stoffen enthält.

1.2.2 SICHERHEIT DER BETRIEBSUMGEBUNG

Das Bedienfeld ist gegen das Eindringen von Flüssigkeiten geschützt. Es ist zu vermeiden, das Gerät der Gefahr von Tropfwasser, Spritzwasser oder dem Eintauchen in Wasser auszusetzen oder in Umgebungen zu verwenden, die solche Gefahren bergen. Geräte, in die versehentlich Flüssigkeiten eingedrungen sind, müssen sofort ausgeschaltet, gereinigt und von autorisiertem und qualifiziertem Personal überprüft werden.

Nach erfolgter Programmierung wird empfohlen, die Klarsichtscheibe zu schließen.

Schutz:

- bei geschlossener Klarsichtscheibe IP65 EN60529
- bei offener Klarsichtscheibe IP54
- EMI /RFI CEI EN55011 - 05/99
- Das Gerät ist innerhalb der angegebenen Umgebungsgrenzwerten für Temperatur, Feuchtigkeit und Druck zu verwenden.

Das Gerät wurde für den Betrieb unter den folgenden Umgebungsbedingungen entwickelt:

- Temperatur der Arbeitsumgebung: $0^{\circ}\text{C} \div +50^{\circ}\text{C}$
- Lager- und Transporttemperatur: $-10^{\circ}\text{C} \div +50^{\circ}\text{C}$
- Relative Luftfeuchtigkeit: $10\% \div 95\%RH$ – nicht kondensierend

VORSICHT



Die Wasseraufbereitungsanlage, in die das Gerät eingeführt wird, muss in Übereinstimmung mit den Betriebsanforderungen der geltenden Gesetzgebung entwickelt sein.

Das Gerät muss perfekt in die Anlage eingefügt werden.

Die Anlage muss unter Einhaltung aller vorgesehenen Sicherheitsvorschriften in Betrieb gehalten werden.

Die auf dem Gehäuse des Betriebsgeräts des Analysators angegebenen Parameter müssen den geltenden Vorschriften entsprechen.

Eventuelle Fehlersignale an das Gerät müssen sich in einer Umgebung befinden, die ständig von Betriebspersonal oder Anlagenbetreuern kontrolliert wird.

Die Nichteinhaltung auch nur einer dieser Bedingungen kann dazu führen, dass die „Logik“ des Geräts in einer für die Benutzer des Service potentiell gefährlichen Weise arbeitet.

Deshalb wird empfohlen, dass das Service-bzw. Wartungspersonal mit äußerster Sorgfalt arbeitet und sofort auf sämtliche Veränderungen der Sicherheitsparameter hinweist, um das Entstehen von möglicherweise gefährlichen Situationen zu vermeiden.

Da die oben genannten Überlegungen nicht durch das betreffende Produkt kontrolliert werden können, kann der Hersteller nicht für Schäden verantwortlich gemacht werden, die diese Fehlfunktionen an Personen oder Gegenständen verursachen könnten.

1.3 WESENTLICHE TECHNISCHE EIGENSCHAFTEN

- Gleichzeitige Messung von: Freiem Chlor, pH, Redox und Temperatur (Optional: Chlor insgesamt, gebundenes Chlor)
- **Programmierung:** mittels Tastatur mit 4 Bubble-Tasten
- LCD STN 240x128 hintergrundbeleuchtet
- Interner Messwertspeicher Flash 4 Mbit Speicher entspricht 16000 Aufzeichnungen mit der Möglichkeit, über Tabellen und Diagramme den Messtrend mit der Anzeige von Minimal-, Maximal- und Durchschnittswerten des Zeitraums zu visualisieren
 - **Aufzeichnungsintervall:** 00:00 ÷ 99:99 min
 - **Typ:** kreisförmig / füllend
 - **Visualisierung:** Tabelle/Diagramm
- **P.I.D.- Regelung für pH Ausgang**
- **RS485 Serieller Ausgang:** MODBUS RTU Protokoll mit programmierbarer Geschwindigkeit 1200 ÷ 38400 Baud Rate, für Setup, Echtzeitzustand oder Daten-Download
- 4 analoge Ausgänge:
 - **Menge:** ppm Cl₂, pH, Redox, Temperatur.
 - **Typologie:** 0.00 / 4.00 ÷ 20.00 mA galvanisch getrennt
 - **Grenzwertprogrammierung:** niedriger / höher / Inversion
 - **Maximale Last:** 500 Ohm
- Ausgang Alarm nach NAMUR 2.4 mA (mit Bereich 4/20mA)
- 2 Alarm-Relaisausgänge (Messwassermangel, Reagenzien erschöpft, verschmorter Projektor, verschmutzte Zelle)
- 2 Relaisausgänge von Sollwert 2 für Chlormessung
- 2 Relaisausgänge von Sollwert 2 für pH-Messung
- 1 Relaisausgänge von Sollwert 2 für Redox-Messung
- 1 Relaisausgang für Sollwert 2 für Temperaturmessung (aber auch gesamtes oder gebundenes Chlor auf Anfrage)

Hauptmerkmale der Hardware des Geräts

- Die Hardwarestruktur dieser Peripherie basiert auf der Anwendung einer extrem neuen CPU CMOS mit 16 Bits, die speziell für die Ausführung der sogenannten "eingebetteten" Anwendungen entwickelt wurde.
- Die Karte verwendet einen EEPROM zur Speicherung der Einstellungsdaten und Flash-Speicher zur Speicherung der Archive der historischen Daten und LOG-Dateien der Ereignisse.
- Die Karte verfügt über 1 RS485-Tor (opto-isoliert) für lokale Netzwerke, die für Verbindungen mit lokalen Kommunikationsgeräten (Konfigurationscomputer, Terminals und Fernbedienungen usw.) verwendet werden.
- In die Karte ist eine Echtzeituhr (Uhr mit Datum) integriert, die es der Software ermöglicht, Zahlen in chronologischer Reihenfolge zu speichern.

1.3.1 TECHNISCHE EIGENSCHAFTEN

Multiparameter-Aggregat zur Bestimmung von:

Freiem Chlor, Chlor insgesamt, pH, Redox, Temperatur und Trübung

Parameter	Bereich	Auflösung	Genauigkeit
Freies Chlor	00,00 ÷ 02,00ppm oder 10,00ppm Cl ₂	0,01ppm	1% v.E.
Chlor insgesamt	00.00 ÷ 10.00ppm Cl ₂	0,01ppm	1% v.E.
pH	00.00 ÷ 14.00 pH	0,01 pH	1% v.E.
Redox	±1000mV	1 mV	1% v.E.
Temperatur	00,0 ÷ 65,0 °C	0,1°C	1% v.E.
Grafikanzeige	TFT 7" Resistiver Touchscreen hintergrundbeleuchtet. Gleichzeitige Visualisierung von Messwerten, Zustand der digitalen Ausgänge, Speicherzustand, Störungen. Touch-Programmierung		
Interner Messwertspeicher	Flash 32 Mbit Aufzeichnungsintervall: 00:00 ÷ 99:99 min Typ: kreisförmig / füllend Visualisierung: Tabelle/Diagramm		
4 Analoge Ausgänge	ppm Cl ₂ , ppm Cl _{tot} , pH, Temperatur Typologie: 0.00 / 4.00 ÷ 20.00 mA galvanisch getrennt Grenzwertprogrammierung: niedriger / höher / Inversion Maximale Last: 500 Ohm P.I.D.- Regelung		
5 Relaisausgänge für Sollwert	Nr. 2 für Chlor + Nr. 2 für pH + 1 für Redox Sollwert mit Hysterese: 00.00 ÷ 05.00 ppm Cl ₂ / 00.00 ÷ 14.00 pH / ± 1500 mV Programmierung der Hysterese Relais max. ohmsche Last 6A bei 250Vac		
2 Alarm-Relaisausgänge	ON-OFF kumulativ für: Min/Max, Sollwert Relais max. ohmsche Last 6A bei 250Vac		
Digitaler Input	Für Durchflusssensor		
RS485 Serieller Ausgang	MODBUS RTU-Protokoll mit programmierbarer Geschwindigkeit 1200 ÷ 38400 Baud Rate für Set-up, Echtzeitzustand oder Daten-Download		
Betriebsbedingungen	Betriebstemperatur: 0÷50°C Lagerung und Transport: -25÷65°C Luftfeuchtigkeit 10-95% nicht kondensiert		
Stromversorgung/ Elektrischer Schutz	Stromversorgung: 90÷260Vac/dc 50-60Hz Durchschnittliche Aufnahme: 30 W Elektrischer Schutz:		
Gehäuse	ABS Einplattengehäuse		

2 ALLGEMEINE BESCHREIBUNG

Die Guardian **Pool_NN** Panel Serie umfasst folgende Modelle:

Nr.	Modell	Code	Beschreibung
1	Guardian Pool_NN 1 Freies Chlor 10 ppm	72700	- Mit Sensor für organisches Chlor (2) 0-10 ppm - Temperatur
2	Guardian Pool_NN 2 Trinkwasser Freies Chlor 2 ppm	72701	- Mit Sensor für organisches Chlor (2) 0-2 ppm - Temperatur
3	Guardian Pool_NN 3 pH und Freies Chlor	72702	- pH - Freies organisches Chlor (2) 0-10 ppm. - Temperatur
4	Guardian Pool_NN 4 pH – ORP	72703	- pH - ORP-Sensor, in Goldelektrode (Sensorex) - Temperatur
5	Guardian Pool_NN 5 pH – ORP – Freies Chlor	72704	- pH - ORP-Sensor, in Goldelektrode (Sensorex) - Freies organisches Chlor (2) - Temperatur
6	Guardian Pool_NN 6 pH, ORP, freies Chlor, Chlor insgesamt, gebundenes Chlor. Eingang für NTU (4- 20mA)	72705	- pH - ORP-sensor, in Goldelektrode (Sensorex), - Freies Chlor - Chlor insgesamt - Trübungs-Sensor - Temperatur
7	Guardian Pool_NN 7 pH, freies Chlor, Eingang für NTU (4- 20mA)	74720	- pH - Freies Chlor - Trübungs-Sensor - Temperatur

HINWEISE:

(1) Bei der ppm-Version, mit der Umwandlung in **Bromid** (Umrechnungsfaktor 2,4) im aktuellen Gerät, kann der Kunde wählen, ob er Chlor oder Bromid messen möchte.

(2) Dieser Sensor kann **NaClO** (Natriumhypochlorit), **Ca(ClO)₂** (Calciumhypochlorit), **Cl₂** (Chlorgas), elektrolytisch erzeugtes Chlor und organische gebundenes Chlor auf Basis von Iso-Cyanursäure (getestet bis zu einer Iso-Cyanursäure-Konzentration von 500 mg/l) messen.

3 PROGRAMMIERUNG

Dieses Handbuch enthält alle Informationen zur Bedienung des Gerätebildschirms. Es werden alle Betriebsfenster mit Fotos und Erklärungen analysiert.

3.1 HAUPTBILDSCHIRM



Abbildung 1 Hauptbildschirm

3.1.1 ALLGEMEINE EINSTELLUNGEN

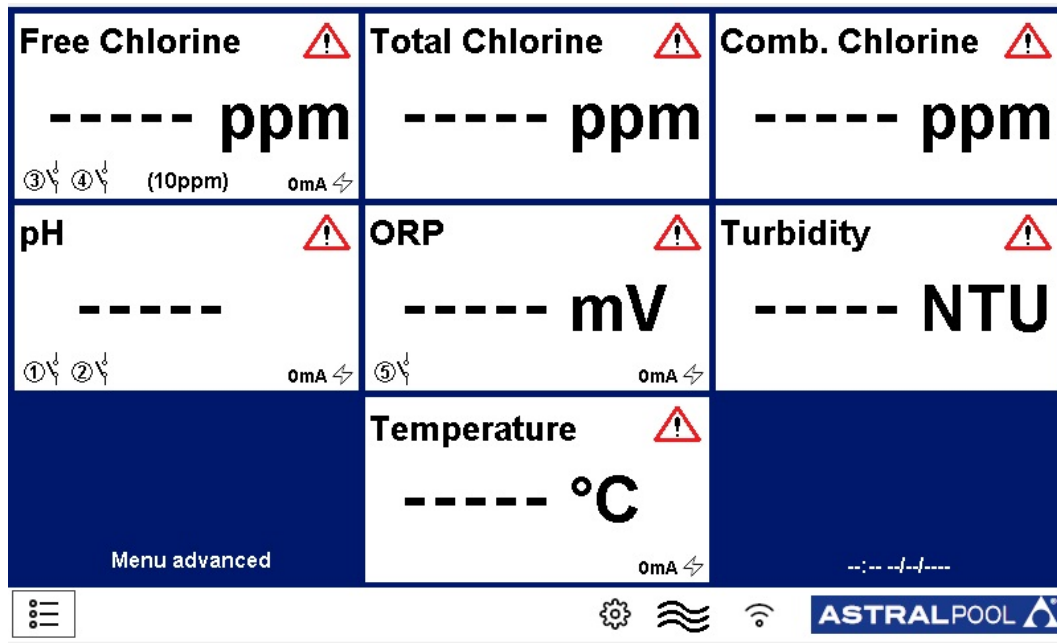

Abbildung 2 Allgemeine Einstellungen

- **Archiv:** So werden Daten gespeichert
 - **SCHRITT:** Auswählen, wie oft das System Daten aufnimmt (Minuten).
 - **TYP:** Den Typ des Datenarchivs bestimmen:
 - **Kreis:** Es nimmt Daten im FIFO-Modus auf.
 - **Begrenzt:** Es nimmt Daten auf, bis es voll ist. Dann muss es geleert werden.
 - **Zurücksetzen:** Die gespeicherten Daten zurücksetzen.
 - **Auf USB-Stick speichern:** Das System speichert Daten auf dem USB-Anschluss.
 - **Datensatz anzeigen: Zeigt die archivierten Daten an.**
 - **Alarmprotokoll: Zeigt die Alarmhistorie an.**

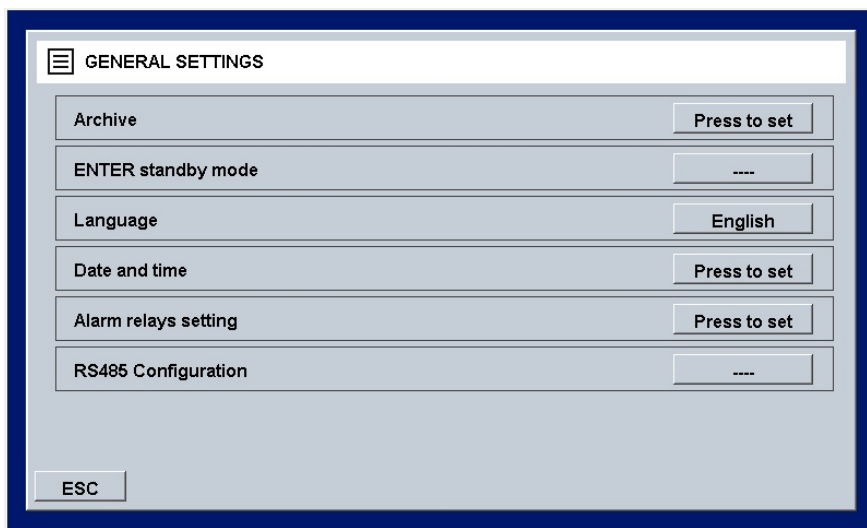

Abbildung 3 Archiveinstellungen

- **ENTER Standby-Modus**
Das System geht in den Standby-Modus, das System misst, aber es führt keine Dosierungen oder Befehle aus.
- **Sprache**
Einstellung der Betriebssystemsprache (Deutsch).
- **Datum und Zeit:**
Einstellung von Datum und Uhrzeit, die im Hauptfenster angezeigt werden.

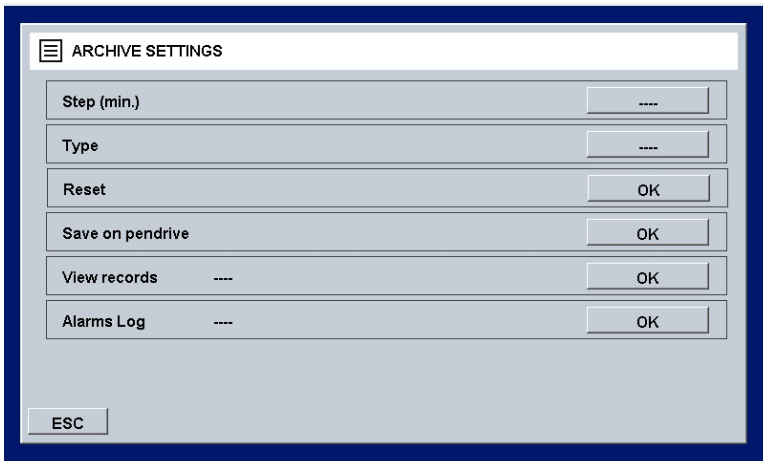

Abbildung 4 Datum und Uhrzeit

- **Einstellung der Alarmrelais**

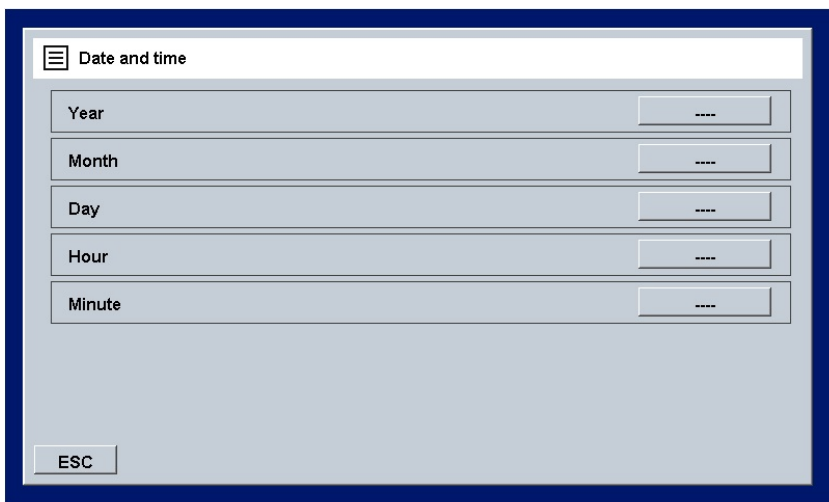

Abbildung 5 Datum und Uhrzeit

Es gibt zwei Alarmrelais, sie können zugewiesen werden:

- **ZUORDNUNG ALARMRELAIS:** Wählen Sie das Maß, bei dem das Relais zugewiesen werden soll. Sie können wählen zwischen: allen Maßnahmen, Kombinations-Chlorsollwert oder Trübungssollwert
- **ALARM-RELAIS-STATUS:** Hier kann der Normalzustand des Relais ausgewählt werden:
NO (Normal Offen)
NC (Normal Geschlossen)
- **VERZÖGERUNG ALARM-RELAIS (SEK):** Die Zeit auswählen (Sekunde), nach der das Relais seinen Status ändert.

3.1.2 WERKSEINSTELLUNGEN

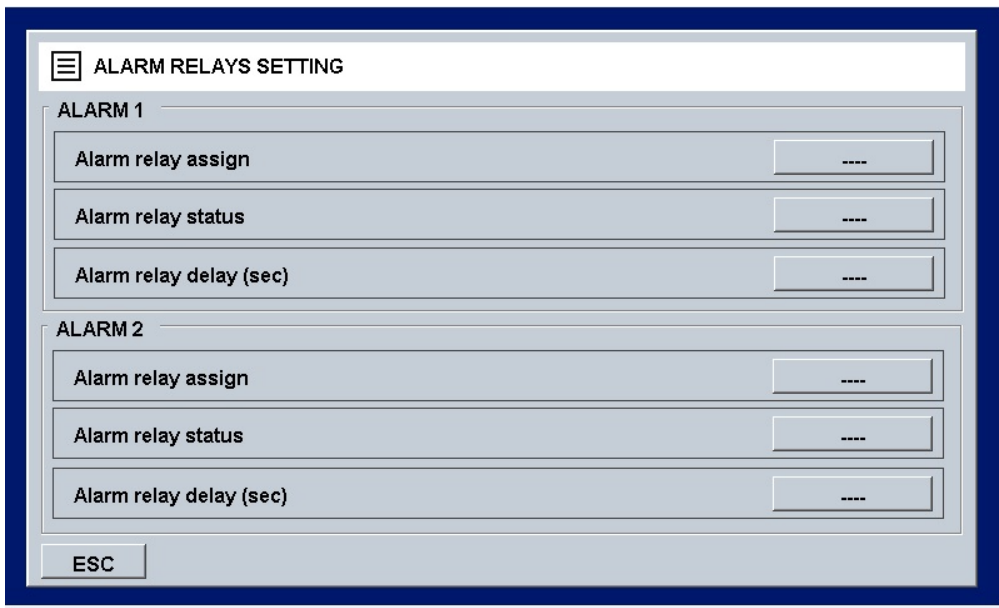

Dieses Fenster ist durch ein Passwort geschützt. Die Erklärung findet sich im Anhang.

3.1.3 DURCHFLUSS



Es gibt zwei Zustände:

 - ON (EIN): Wenn Durchfluss vorhanden ist.

 - OF (AUS): Wenn kein Durchfluss vorhanden ist.

3.1.4 WI-FI

Dieses Symbol zeigt an, ob eine Wi-Fi-LAN-Verbindung vorhanden ist.

Um eine Verbindung mit dem Wi-Fi-LAN-Netzwerk herzustellen, wie folgt vorgehen:

- 1) Das Wi-Fi SSID-XXXX mit einem Telefon oder PC verbinden; das Netzwerkpasswort lautet: **1234567890**
- 2) Einen Browser starten und eine Verbindung mit folgender Adresse herstellen: **192-168.4.1** und folgende Daten für das Login verwenden:
 - Benutzername: **admin**
 - Passwort: **0000**
- 3) Ist die Verbindung erfolgt, sicherstellen, dass auf der oberen linken Seite des Dashboards neben **UP since_** Das Datum und die Uhrzeit des Einschaltens der Karte erscheint



Abbildung 6 Menü Sollwert

3.1.5 DATUM UND UHRZEIT

10:00 03/05/2019

Zeigt das Datum und die Uhrzeit an, die im Menüfenster eingestellt sind.

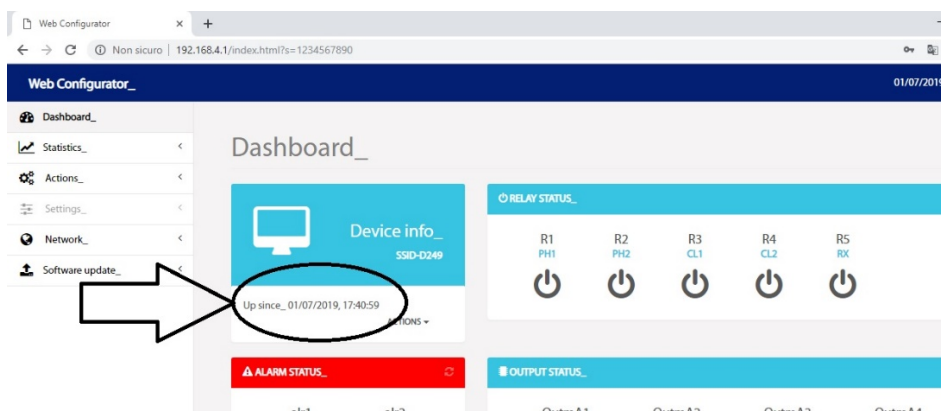
3.2 MESSUNGEN



Abbildung 7 Hauptfenster

Wird im Hauptfenster auf die Registerkarte der Messung getippt, öffnet sich diese (Abbildung 7):

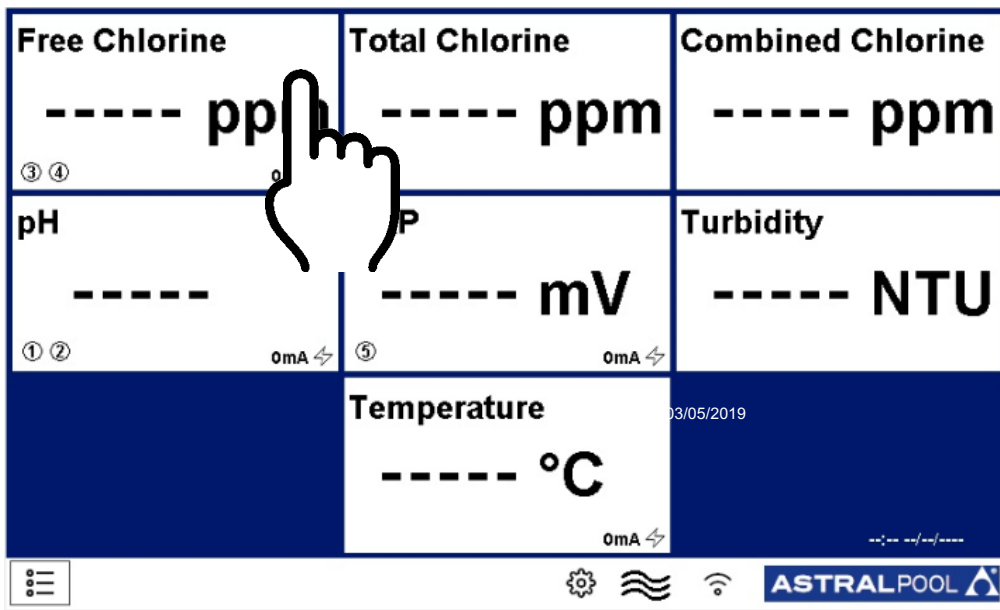

Abbildung 8 Menü Messung

Dieses Fenster ist für alle Messungen gleich.

3.2.1 SOLLWERT

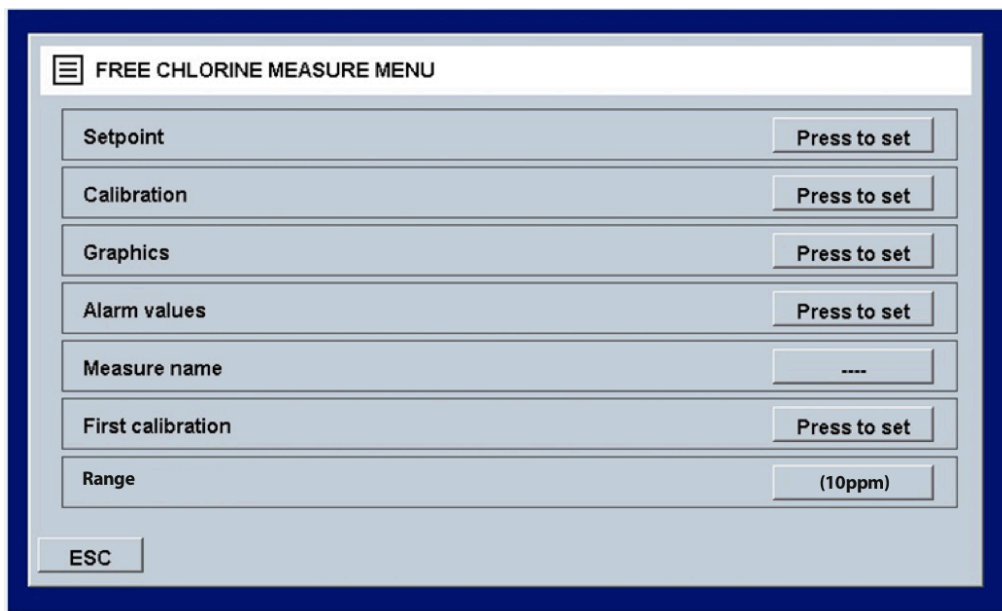
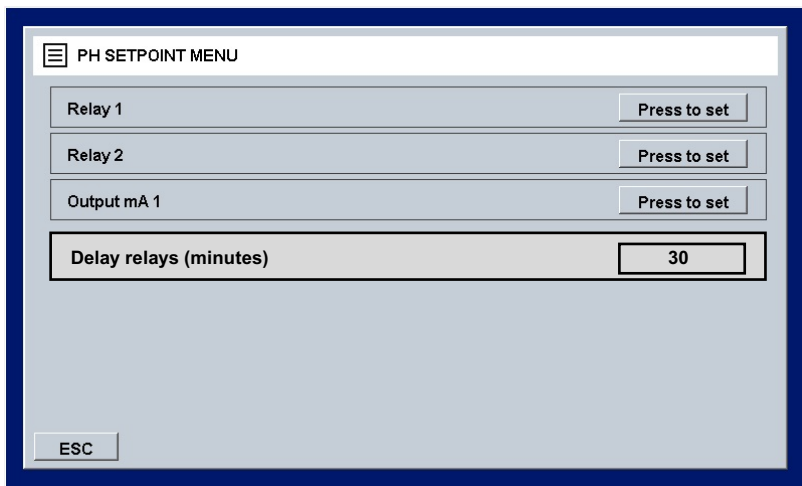

Notiz:

das Menü "Verzögerungsrelais" betrifft nur die Relais 3 und 4 des freien Chlors, es wird beim Einschalten des Geräts aktiviert, es hat die Funktion, auf eine Polarisationszeit der Sonde für freies Chlor zu warten, auf dem Hauptbildschirm wird eine Sanduhr  angezeigt.

Abbildung 9 Menü Sollwert

- **Relais**

Die verwendbare Relaisnummer ist für die Messungen unterschiedlich:

- **Relais Nr. 1, 2 pH;**
- **Relay Nr. 3, 4 Freies Chlor;**
- **Relais Nr. 5 pH;**



Abbildung 10 Menü Relais Sollwert

Es ist das dem Relais zugeordnete Fenster:

SOLLWERT: Wert des Sollwertes in ppm einstellen

HYSTERESE: Den Bereich um den Sollwert einstellen (Sollwert \pm Hysterese ist der Bereich)

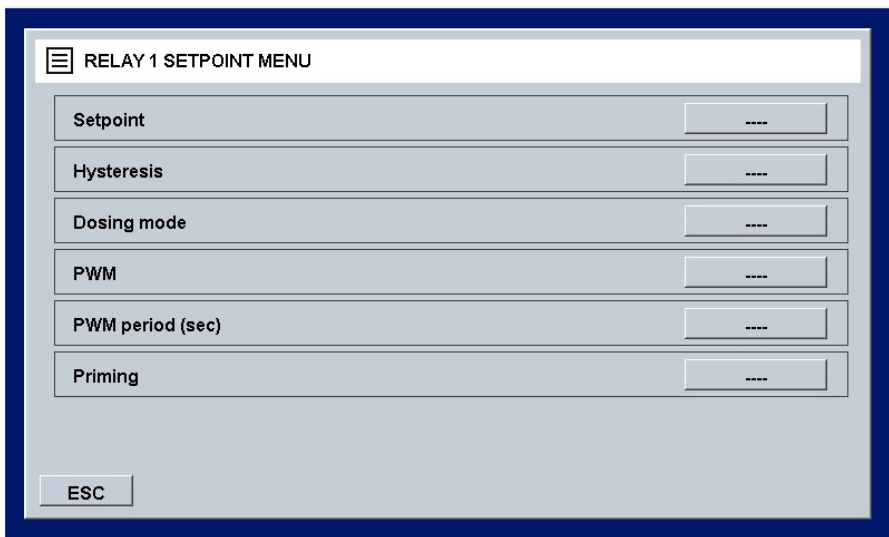
DOSIERMODUS: Den Relais-Modus einstellen:

- **HOCH:** Das Relais schließt, wenn der Messwert kleiner als der Sollwert \pm Hysterese ist, und öffnet, wenn der Messwert größer als der Sollwert \pm Hysterese ist
- **NIEDRIG:** Das Relais öffnet, wenn der Messwert kleiner als der Sollwert \pm Hysterese ist, und schließt, wenn der Messwert größer als der Sollwert \pm Hysterese ist

Vorbereitung: Es ist möglich, die den Produkten zugeordneten Dosierpumpen von Hand zu aktivieren.

Beispiele für HOCH/NIEDRIG:

Dosing mode: HIGH



Abbildung 1 Menü Relais Sollwert

Es ist möglich, den Wert der Messung zu erhöhen, wenn er unter einen gewählten Wert fällt. Das Relais schließt, wenn der Messwert unter dem Minimum des Bereichs liegt, und es öffnet, wenn er wieder das Maximum des Bereichs erreicht.

Dosing mode: LOW

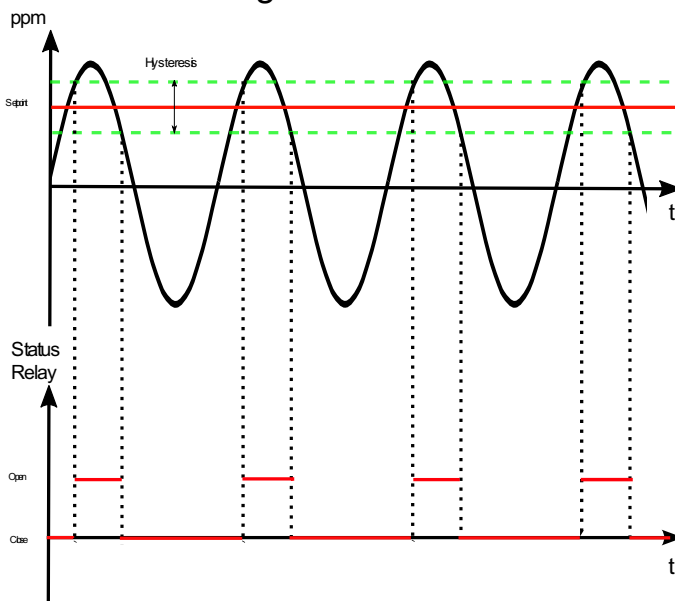

Abbildung 2 Menü Relais Sollwert

Es ist möglich, den Wert der Messung zu mindern, wenn er über einen gewählten Wert steigt.

Das Relais schließt, wenn der Messwert über dem Maximum des Bereichs liegt, und es öffnet, wenn er wieder das Minimum des Bereichs erreicht

- **AUSGANG mA**

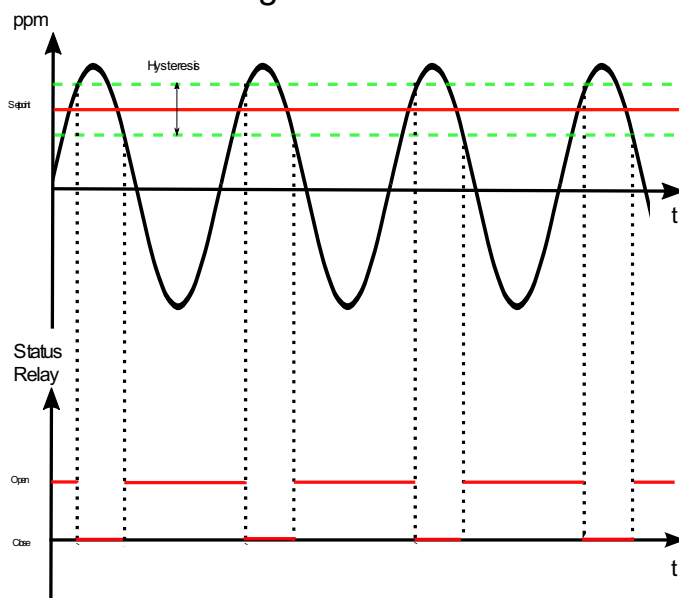
Die verwendbare Nummer für den Ausgang mA ist für die Messungen unterschiedlich:

- **Ausgang mA 1** pH;
- **Ausgang mA 2** Freies Chlor;
- **Ausgang mA 3** Rx;
- **Ausgang mA 4** Temperatur;



Abbildung 53 Einstellungsmenü Ausgang

Dies ist für Ausgang mA reservierte Fenster:

UNTERER Grenzwert: Den Minimalwert des Ausgangs einstellen.

OBERER Grenzwert: Den Maximalwert des Ausgangs einstellen.

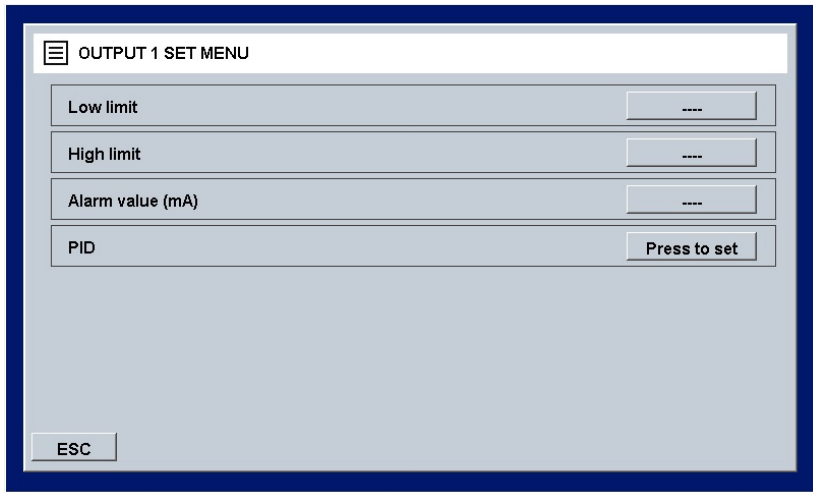
Alarmwert (mA): Den Wert einstellen, bei dessen Überschreitung ein Alarm ausgelöst wird.

PID: Drücken, um das PID-Fenster zu öffnen



Abbildung 14 Menü PID-Einstellung

PID: Aktiviert PID am Ausgang (ON/OFF) (EIN/AUS).

PID-Sollwert: Stellt den Sollwert des PID ein.

PID-Algorithmus: Stellt die Art des PID (P/I/D) ein.

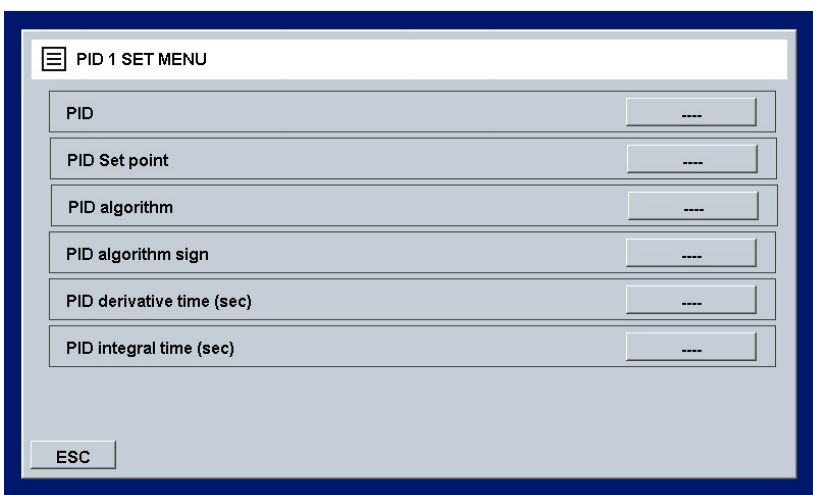
PID-Algorithmus-Vorzeichen: Stellt die Art der Kontrolle ein (Direkt/Invers).

- **Logik Max. Wert / Logik Min. Wert**

Wenn die Hysterese nicht vorhanden ist, können der obere und untere Grenzwert eingestellt werden; wenn die Messung diese Werte überschreitet, wird ein Alarm erzeugt.

3.2.2 KALIBRIERUNG



Abbildung 15 Kalibrierung

Diese Registerkarte zeigt die Kalibriermethode für Messungen an; den Anweisungen auf dem Bildschirm folgen:

Die Sonde in den Puffer einführen, warten, bis die Messung stabil ist (in den eingekreisten Bereichen) und dann OK drücken. Es öffnet sich das folgende Fenster:

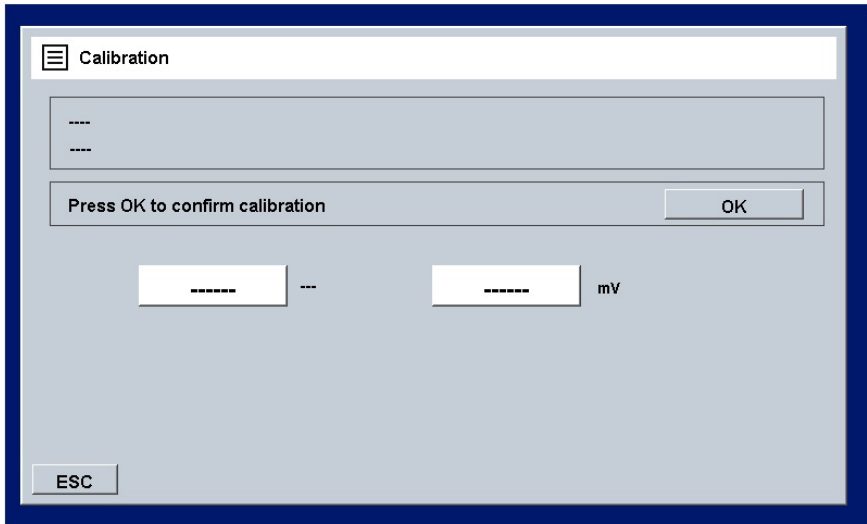

Abbildung 66 Wert einstellen

Den Pufferwert einstellen und OK drücken.

Nur der pH-Wert erfordert eine 2-Punkt Kalibrierung (mit 4 pH- und 7 pH-Pufferlösungen): Drückt man auf „Kalibrieren“, öffnet sich das Fenster mit den anderen Kalibrierungen.

3.2.3 GRAFIKEN



Abbildung 7 Menü Grafiken

- **Min. Wert in Diagramm:** Min. Wert an der Grafik einstellen
- **Max. Wert in Diagramm::** Max. Wert an der Grafik einstellen
- **Zeiteinstellung Grafik:** Zeitachsen einstellen
- **Grafiken:** Drücken, um die Grafik anzuzeigen (Abbildung 18)

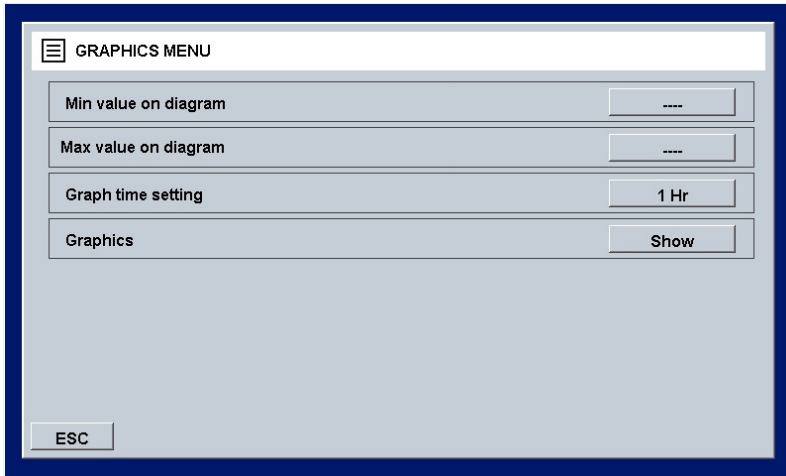

Abbildung 8 Grafik

3.2.4 ALARMWERTE

Stellt den Max. / Min.-Wert ein, über / unter dem der Alarm aktiviert wird

3.2.5 NAME MESSUNG

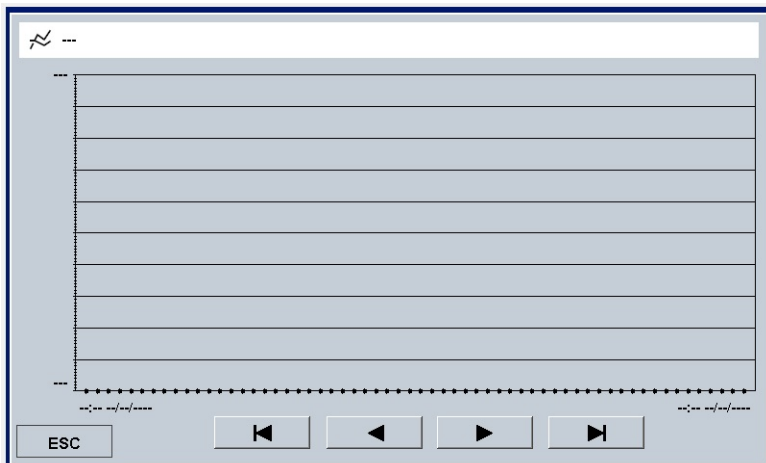
Ermöglicht die Änderung des Namens der Messung in dieser Registerkarte

3.2.6 ERSTE KALIBRIERUNG

Die erste Kalibrierung erst nach einer Wartezeit von 90 Minuten durchführen

3.2.7 BEREICH

Den Betriebsmessbereich der Sonde einstellen.

4 INSTALLATION

Vor der Einstellung des **AstralPOOL multi-parameter** folgende Informationen sorgfältig durchlesen. Dieser Abschnitt beschreibt die Schritte zur Installation des Geräts und der elektrischen Verkabelung. Diese Hinweise bei der Installation beachten.

- Sicherstellen, dass das Gerät und alle zugehörigen Geräte vor Beginn der Arbeiten ausgeschaltet sind.
- Sollten Störungen oder Warnsignale auftreten, die Arbeiten sofort stoppen. Die Arbeiten erst dann wieder aufnehmen, wenn die Ursachen des Problems beseitigt wurden.
- Das Gerät nicht an gefährlichen Orten oder in feuer- und explosionsgefährdeten Bereichen installieren.
- Elektrische Gefährdungen vermeiden. Niemals beschädigte oder defekte Geräte verwenden.

4.1 INSTALLATIONS-BAUSATZ



Nummer	Artikel	Pool_N	Pool_N	Pool_N	Pool_N	Pool_N	Pool_N	Pool_N
		N 1	N 2	N 3	N 4	N 5	N 6	N 7
	Code	72700	72701	72702	72703	72704	72705	74720
1	Befestigungsschrauben	•	•	•	•	•	•	•
2	8x12 PVC-Schlauch 4 Meter	•	•	•	•	•	•	•
3	Sondenhalter	•	•	•	•	•	•	•
4	Steckverbinder	•	•	•	•	•	•	•
5	2 ppm Freies Chlor-Sonde		•					
6	10 ppm Freies Chlor-Sonde	•		•		•	•	•
7	10 ppm Sonde Chlor insgesamt						•	
8	Chlor Kabel 1 Meter	•(x1)	•(x1)	•(x1)		•(x1)	•(x2)	•(x1)
9	pH-Sonde			•	•	•	•	•
10	Redox-Sonde				•	•	•	
11	pH7- und 4pH-Pufferlösung			•	•	•	•	•
12	465 mV Redox-Pufferlösung				•	•	•	
13	80µm Kerzenfilter	•	•	•	•	•	•	•
14	Rückspülsystem	(*1)	(*1)	(*1)	(*1)	(*1)	(*1)	(*1)
15	PSS8 Halter Trübungs-Sonde						•	

16	Trübungs-Sonde						•	
17	Temperaturfühler	•	•	•	•	•	•	•
18	Leitfähigkeitssonde und Kabel	(*1)	(*1)	(*1)	(*1)	(*1)	(*1)	(*1)

(*1 auf Anfrage).

4.2 WANDMONTAGE

Die Steuereinheit entfernt von Wärmequellen, an einem trockenen, spritzwasserfreien und tropfwassergeschützten Ort bei Temperaturen unter 40°C montieren. Die Mindesttemperatur darf nicht unter 0°C fallen.

Bei der Montage der Steuereinheit ist darauf zu achten, dass genügend Platz für die Kabel und Anschlüsse bleibt.

An der Platte auf der Rückseite der Steuereinheit befinden sich in der Nähe der Ecken 4 Bohrungen für die Wandmontage des Geräts. Die nachstehende Abbildung zeigt die Position der Bohrlöcher und die maximalen Abmessungen der Platte.



Abbildung 9 Wandmontage des Systems

Die mitgelieferten Dübel verwenden, wenn diese für den Halt geeignet sind, ansonsten einen passenden Typ auswählen. Das Gerät wird bereits montiert und intern verdrahtet geliefert.

Um einen optimalen Halt des Systems zu gewährleisten, muss die Wand so gerade und eben wie möglich sein.

Zwei horizontal ausgerichtete Löcher in einer Höhe bohren, die dem Bediener eine korrekte Sicht auf das Bedienfeld und eine geeignete Position für die Kalibrier- und Steuervorgänge ermöglicht.

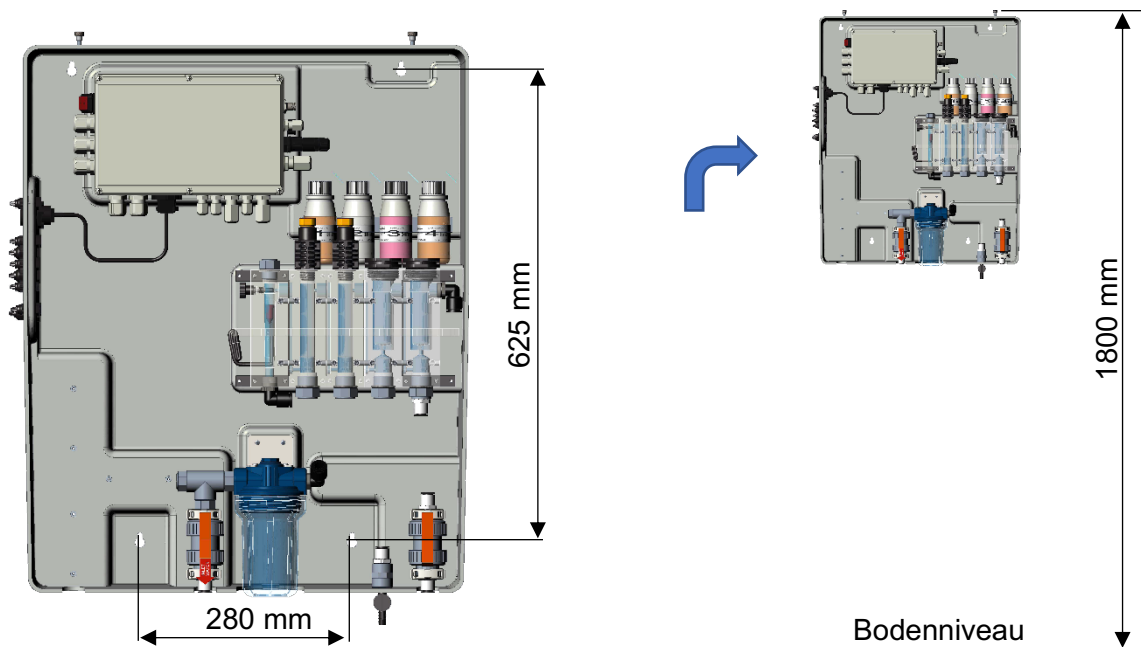
Die empfohlene Höhe vom Boden aus ist etwa 180 cm oder zumindest Augenhöhe.

Der Abstand zwischen den Bohrungen ist in der obenstehenden Abbildung angegeben.

Bei der Installation eine Wasserwaage verwenden, um das Steuergerät korrekt auszurichten.

Die Gesamtabmessungen des Gehäuses sind: 730x600x230 mm (H x L x T)



Abbildung 10 Systemabmessungen

4.3 ANSCHLUSSKLEMMENBLOCK

Vor der Installation des **Astralpool multi-parameter** folgende Informationen sorgfältig durchlesen



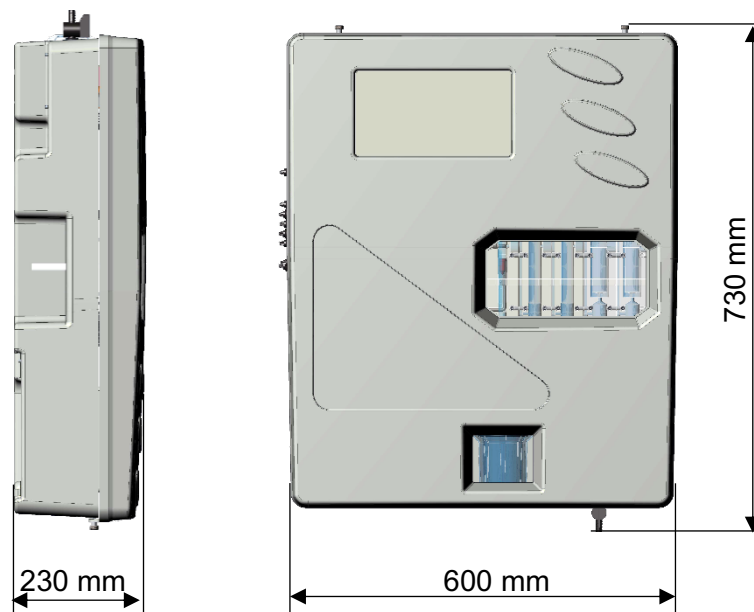





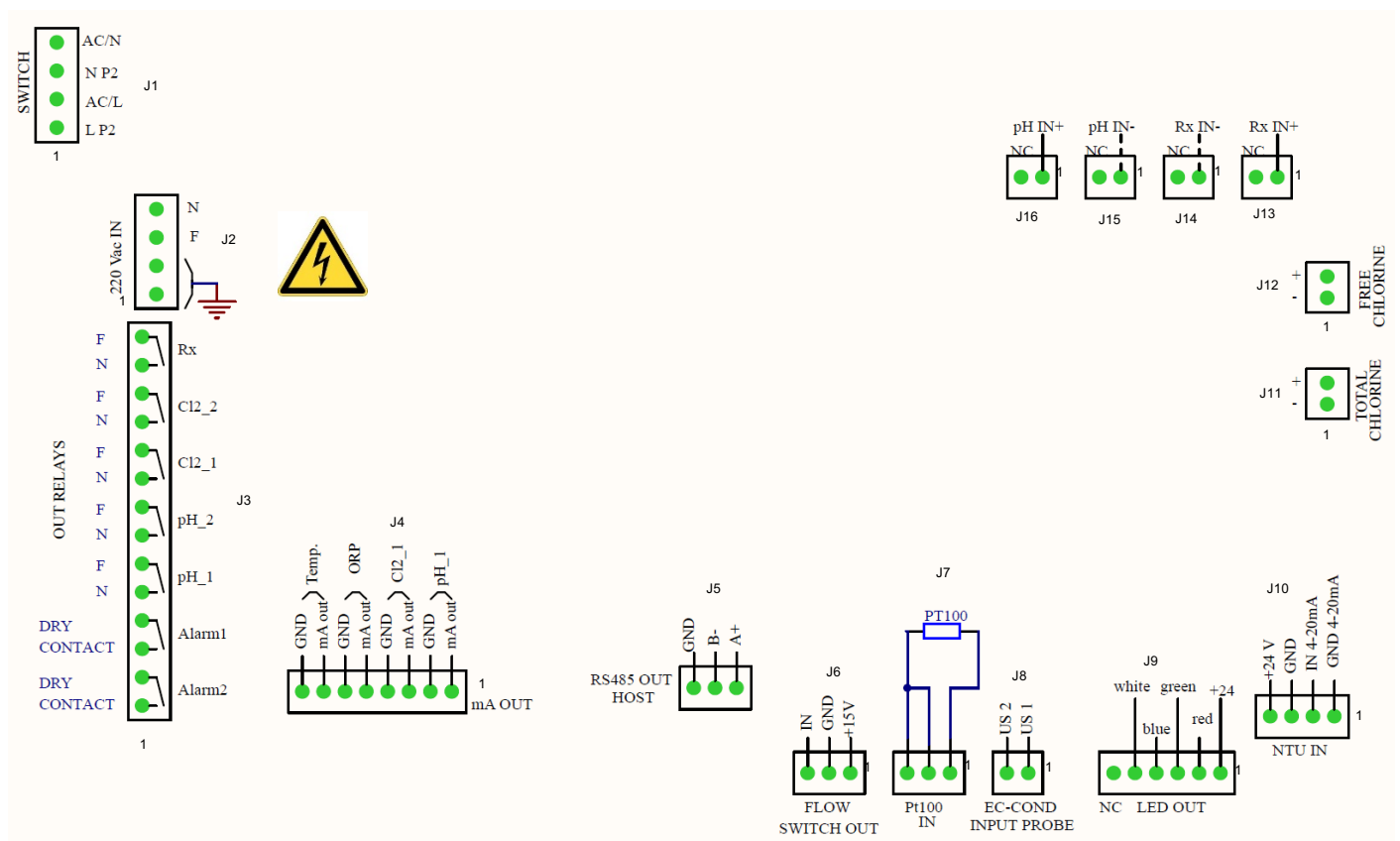
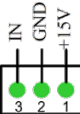

Abbildung 11 Anschlüsse

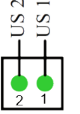
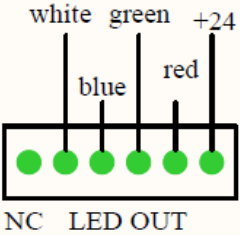
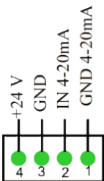
Verbinder	Klemme	ABBILDUNG	BESCHREIBUNG	
J1	1		Nullleiterkabel AC-Stromversorgung	
	2		220 Vac Nullleiterkabel	
	3		Netzkabel AC-Stromversorgung	
	4		220 Vac Netzkabel	
J2	1		Erdungskabel 1	
	2		Erdungskabel 2	
	3		220 Vac-Stromversorgung Netzkabel	
	4		220 Vac-Stromversorgung Nullleiterkabel	
J3	1	ALARM 2	Fernalarm (2) Relais	Potentialfreier Kontakt
	2		Fernalarm (2) Relais	
	3	ALARM 1	Fernalarm (1) Relais	Potentialfreier Kontakt
	4		Fernalarm (1) Relais	
	5	pH_1	pH-Sollwert 1	Gespeister Kontakt (100-240Vac)
	6		pH-Sollwert 1	
	7	pH_2	pH-Sollwert 2	Gespeister Kontakt (100-240Vac)
	8		pH-Sollwert 2	
	9	Cl2_1	Cl ₂ Sollwert 1	Gespeister Kontakt (100-240Vac)
	10		Cl ₂ Sollwert 1	
	11	Cl2_2	Cl ₂ Sollwert 2	Gespeister Kontakt (100-240Vac)
	12		Cl ₂ Sollwert 2	
	13	RX	Rx-Sollwert	Gespeister Kontakt (100-240Vac)
	14		Rx-Sollwert	
J4	1	pH_1	mA pH positives Kabel	
	2		mA pH negatives Kabel	
	3	Cl2_1	mA Cl ₂ (1) positives Kabel	
	4		mA Cl ₂ (1) negatives Kabel	
	5	ORP	mA ORP positives Kabel	
	6		mA ORP negatives Kabel	
	7	Temp	mA Temperatur positives Kabel	
	8		mA Temperatur negatives Kabel	
J5	1		RS485-Schnittstelle (A+)	
	2		RS485-Schnittstelle (B-)	
	3		RS485-Schnittstelle (Masse)	

(* 1 Das Alarmrelais ist einstellbar auf: Alarm Alle messen, Comb. CL-Sollwert; Trübungssollwert)

Verbinder	Klemme	ABBILDUNG	BESCHREIBUNG	
J6	1		+15 V Kabel	
	2		Erdungskabel	
	3		IN Kabel	
J7	1		PT 100 Anschlusskabel	
	2		PT 100 Anschlusskabel	
	3		PT 100 Anschlusskabel	
J8	1		Elektrische Leitfähigkeitssonde	μS Kabel 1
	2			μS Kabel 2
J9	1		+24V	
	2		Rot	
	3		Grün	
	4		Blau	
	5		Weiß	
	6		NC	
J10	1		Trübungs-Sonde	4-20 mA (Masse)
	2			4-20 mA (IN)
	3			Netzstromversorgung 24 V-
	4			Netzstromversorgung 24 V+
J11	1		Sensor Chlor insgesamt	Cl _{tot} negatives Kabel
	2			Cl _{tot} positives Kabel
J12	1		Sensor Freies Chlor	Cl ₂ negatives Kabel
	2			Cl ₂ positives Kabel
J13	1		ORP-Sonde	RG 174 Rx (IN +)
	2			
J14	1			RG 174 Rx (IN -)
	2			
J15	1		pH-Sonde	RG 174 pH (IN -)
	2			
J16	1			RG 174 pH (IN +)
	2			

4.4 ELEKTRISCHE ANSCHLÜSSE

Anschlüsse Klemmenblock:

N	Artikel	Funktion	Pool_NN 1	Pool_NN 2	Pool_NN 3	Pool_NN 4	Pool_NN 5	Pool_NN 6	Pool_NN 7
	Code		72700	72701	72702	72703	72704	72705	74720
1	100-240Vac 50-60Hz	Stromversorgung	•	•	•	•	•	•	•
2	Relais1 (pH1)	Dosiswirkung gespeist			•	•	•	•	•
3	Relais2 (pH2)	Dosiswirkung gespeist			•	•	•	•	•
4	Relais3 (CL1)	Dosiswirkung gespeist	•	•	•		•	•	•
5	Relais4 (CL2)	Dosiswirkung gespeist	•	•	•		•	•	•
6	Relais5 (Rx)	Dosiswirkung gespeist				•	•	•	
7	Relais6 (Alr1)	Alarmstatus potentialfreier Kontakt	•	•	•	•	•	•	•
8	Relais7 (Alr2)	Alarmstatus potentialfreier Kontakt	•	•	•	•	•	•	•
9	mA1 (pH)	Ausgang mA			•	•	•	•	•
10	mA2 (Cl)	Ausgang mA	•	•	•		•	•	•
11	mA3 (Rx)	Ausgang mA				•	•	•	
12	mA4 (°C)	Ausgang mA	•	•	•	•	•	•	•
13	RS485 Serielle Schnittstelle	Kommunikation	•	•	•	•	•	•	•
14	Reed Eingang	Durchflusstatus Eingang	•	•	•	•	•	•	•
15	pH-Sonde	Eingang mV-Signal			•	•	•	•	•
16	CL-Sonde1	Eingang mA-Signal	•	•	•		•	•	•
17	CL-Sonde2	Eingang mA-Signal						•	
18	Trübungs-Sonde	Eingang mA-Signal						•	•
19	RX-Sonde	Eingang mV-Signal				•	•	•	
20	Temp.-Sonde	Eingang Ohm-Signal	•	•	•	•	•	•	•
21	5 VDC Ausgang	Stromversorgung für LED-Leuchte	•	•	•	•	•	•	•
22	Wi-Fi-Verbindung	Wi-Fi-Verbindung	•	•	•	•	•	•	•
23	Leitfähigkeitssonde	Eingang mV-Signal	•	•	•	•	•	•	•

4.5 HYDRAULISCHE ANSCHLÜSSE



Abbildung 12 Hydraulische Anschlüsse

4.6 ANSCHLUSS DER SONDEN

4.6.1 pH- & REDOX-SONDE ANSCHLUSS

Abbildung 13 pH- und Redox-Verbinder

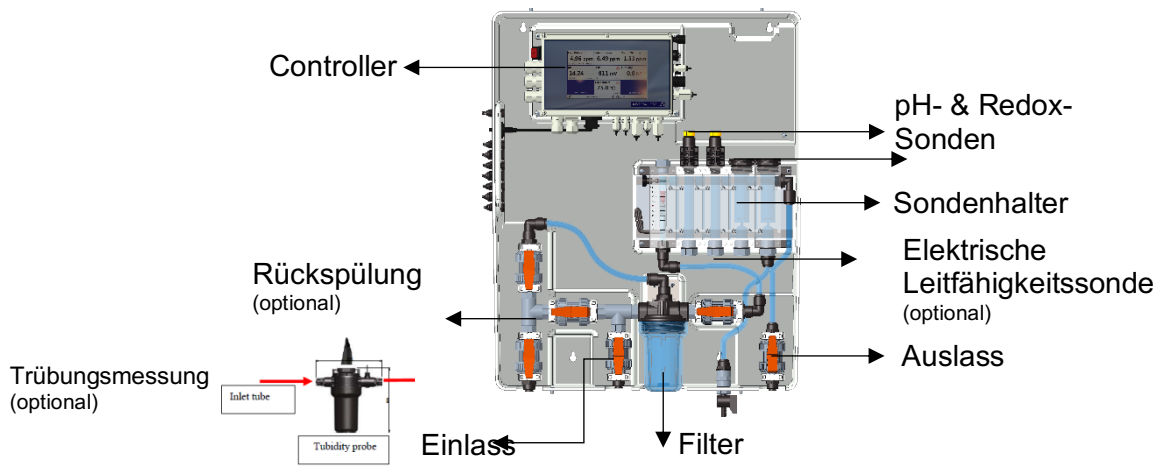
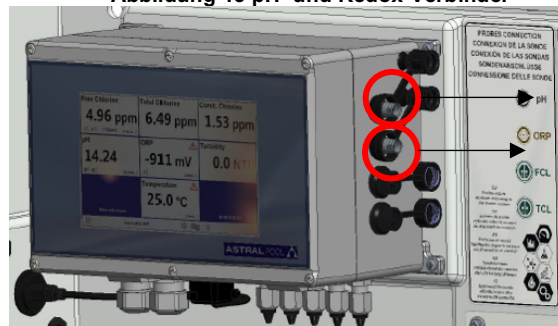

Verbinder pH-Sonde

Verbinder Redox-Sonde

4.6.2 ANSCHLUSS DER LEITFÄHIGKEITSSONDE

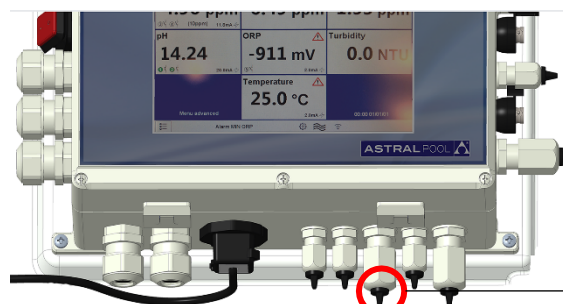

Verbinder Leitfähigkeitssonde
(optional)

Abbildung 14 Leitfähigkeit Verbinder

4.6.3 ANSCHLUSS DER CHLORSONDE



Verbinder Sonden freies Chlor
und Chlor insgesamt

Abbildung 15 Verbinder Chlor

(Hinweis: Bitte überprüfen Sie die Anschlüsse auf dem Etikett mit der Polarität der Chlorsonden)

4.6.4 ANSCHLUSS DES TEMPERATURFÜHLERS

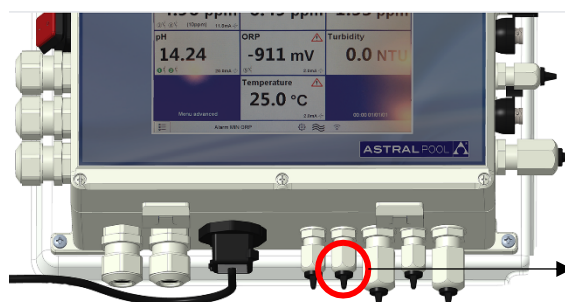

Verbinder Temperaturfühler

Abbildung 16 Verbinder Temperatur

5 INBETRIEBNAHME UND BETRIEB

5.1 INBETRIEBNAHME

Das System mit dem Netzschalter an der oberen linken Seite des Controllers einschalten.



Abbildung 17 Netzschalter

5.2 BETRIEB

- A: Einlassschlauch anschließen
- B: Ausgangsschlauch anschließen
- C: Durchflussregelung vollständig öffnen
- D: Filterluft entgasen

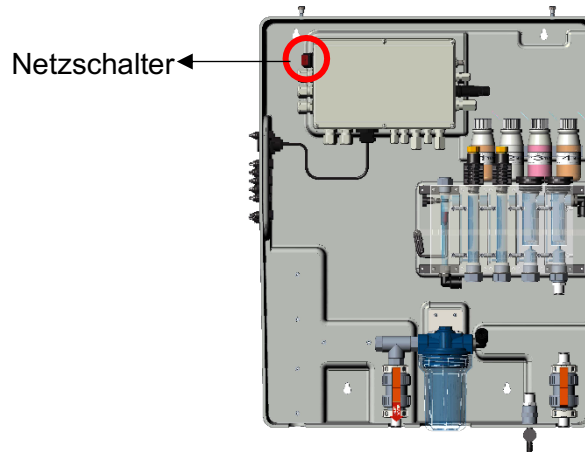
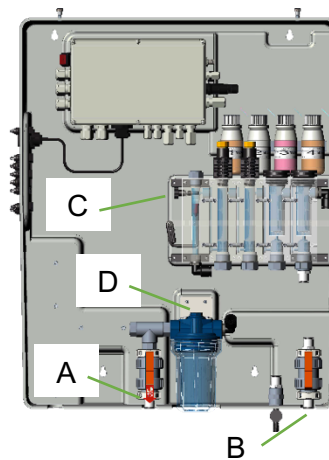

5.3 DURCHFLUSSREGULIERUNG

Der Wasserdurchfluss muss mit dem in der nachstehenden Abbildung gezeigten Ventil eingestellt werden



Abbildung 18 Durchflussreguliertventil

6 WARTUNG

Um stets eine optimale Leistung des Geräts zu gewährleisten, muss es regelmäßig gewartet werden. Wir empfehlen außerdem, unsere Wartungsprogramme einzuhalten.

Nachstehend findet sich eine Angabe zu den maximalen Wartungsintervallen:

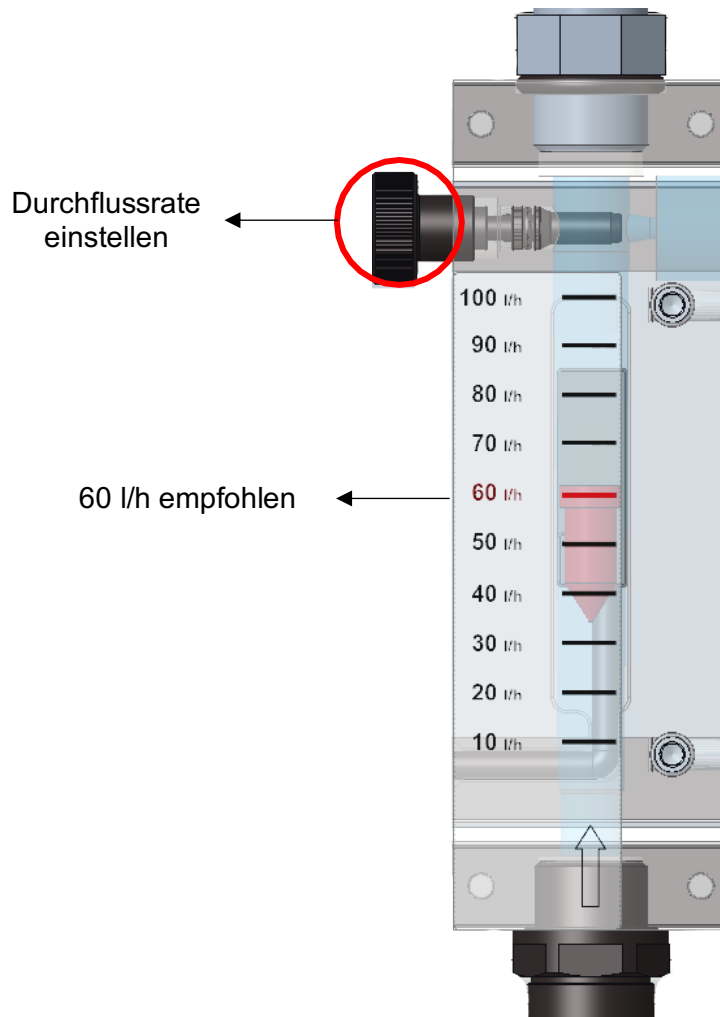
Wartungsarbeiten	ZEITINTERVALLE			
	1 Monat	2 Monate	3 Monate	6 Monate
Allgemeine Systemreinigung				X
Reinigung des Wasserfiltergewebes	X			
Überprüfung des Hydraulikkreises		X		
Reinigung der Sonden	Gemäß der Bedienungsanleitung der Elektrode/Sonde.			

VORSICHT



Das Gerät vor der Durchführung von Wartungsarbeiten von der Stromzufuhr trennen, indem der Hauptschalter der Anlage, in der sich das Gerät befindet, gedrückt wird.

VORSICHT



Vor der Durchführung von Wartungsarbeiten den Wasserdurchfluss, mit dem System das Gerät speist, stoppen und durch vollständiges Öffnen des Probeentnahmeventils drucklos stellen..

6.1 ALLGEMEINE SYSTEMREINIGUNG

Diesen Vorgang einmal im Monat durchführen.

Alle Oberflächen des Geräts regelmäßig reinigen. Nur ein feuchtes Tuch ohne Zusatz von Lösungsmitteln oder Produkten verwenden.

6.2 WASSERFILTER REINIGEN /AUSWECHSELN

Diesen Vorgang alle zwei Monate durchführen.

Warten, bis kein Wasser mehr aus dem Hydraulikkreislauf austritt.

Den Träger der Filtereinheit abschrauben und die Filterpatrone aus dem Inneren herausnehmen; darauf achten, dass die Dichtungen nicht verloren gehen.

Die Patrone unter fließendes Wasser halten und alle Verunreinigungen mit einer weichen Bürste aus dem Filter entfernen. Die Filterpatrone und den Träger wieder in das System einsetzen und darauf achten, die Dichtungen wieder richtig anzubringen.

Das Probeentnahmeventil vollständig schließen und den Wasserfluss im Kreislauf wieder herstellen, indem die Ventile schrittweise geöffnet werden und die Luft aus dem System abgelassen wird. Das System wieder mit Strom versorgen und die Betriebsbedingungen überprüfen, nachdem der erste Test durchgeführt wurde.

6.3 REINIGUNG DER ELEKTRODE/SONDE

Vor der Durchführung dieses Vorgangs die Betriebsanleitung für die Elektrode/Sonde durchlesen.

Warten, bis kein Wasser mehr aus dem Hydraulikkreislauf austritt. Die Elektrodenkabel trennen, indem die Stecker an ihren Enden und die Befestigungsklemmen abgeschraubt werden, dann aus der Sondenhalterung im Hydraulikkreislauf der Anlage entfernen. Das empfindliche Ende mit warmem Wasser und milder Seife abwaschen, dabei eventuelle Fettreste mit einem Pinsel mit weichen Borsten entfernen.

Zur Reinigung die Sonden diese nicht mit scheuernden Gegenständen oder Tüchern, die sie elektrostatisch aufladen könnten, reiben.

Bei extremer Verschmutzung die Elektroden mit vergälltem Alkohol reinigen. Nach Abschluss der Reinigungsarbeiten die Elektroden wieder an die entsprechenden Kabel anschließen und kalibrieren, ohne den Wasserfluss zum System wieder herzustellen. Nach Abschluss des Kalibriervorgangs das System von der Stromversorgung trennen und die Elektroden wieder in die Sondenhalter einsetzen. Die Stromversorgung und den Wasserdurchfluss zum System wieder anschließen, nachdem das Probeentnahmeventil geschlossen wurde.

6.4 ÜBERPRÜFUNG DES HYDRAULIKKREISES

Diesen Vorgang alle sechs Monate durchführen.

Eine Sichtprüfung des Hydraulikkreises des Geräts durchführen, nachdem es von der Stromversorgung getrennt wurde. Bei Vorhandensein von Flüssigkeitsaustritt, Leitungsschäden oder Dichtungsproblemen erst auf den Hydraulikkreis einwirken, nachdem der Wasserzufluss zur Station unterbrochen wurde und das System durch Öffnen des Probeentnahmeventils drucklos gestellt wurde.

Die beschädigten Teile nur durch Originalersatzteile oder empfohlene Ersatzteile ersetzen.

VORSICHT



Keine Verunreinigungen im Hydraulikkreis zurücklassen, die ihn verstopfen könnten.

VORSICHT



Vor der Wiederherstellung des Wasserdurchflusses zum System das Probeentnahmeventil schließen. Den Systemdruck schrittweise wieder aufbauen und dann das Gerät einschalten.

7 FEHLERBEHEBUNG

Mechanische Störungen	
Der Durchfluss in der Messzelle ist zu gering	<ul style="list-style-type: none"> Alle Dichtungen der O-Ringe überprüfen Prüfen, ob der Filter verstopft ist Die Einlass- und Auslassventile überprüfen Das Probeentnahmeventil überprüfen
Elektrische Störungen	
Kein Leuchtsignal, Display ausgeschaltet	Überprüfen, ob das Gerät richtig mit Strom versorgt wird (Steckdose und Stecker). Falls das Gerät inaktiv bleibt, bitte unser Service-Center kontaktieren
Falsche Messungen	<ul style="list-style-type: none"> Die Kalibrierung sorgfältig überprüfen, im Zweifelsfall das Gerät auf die Werkseinstellungen zurücksetzen Die korrekte Funktion der Sonden und deren Verschleißzustand überprüfen

Manchmal kann Flüssigkeit durch einen losen Anschluss oder eine Ringmutter oder einfach durch den Bruch des Wasserzulaufschlauchs austreten. Wenn das Leck beseitigt ist, muss das System vom Restwasser gereinigt und dann getrocknet werden, da dieses durch Verbleib im System die berührten Teile beschädigen könnte.

8 ANHANG

VORSICHT WALTEN LASSEN



Diese REGISTERKARTE ist durch ein Passwort geschützt. Sie wird in dieser Anleitung nur zur Information aufgeführt.

ANHANG 1 - WERKSEINSTELLUNGEN



Abbildung 19 Werkseinstellungen

8.1 PLUS-VERSION

Ermöglicht die Auswahl der gewünschten Version:

- PLUS 1 (Guardian NN 1): Freies Chlor 10 ppm und Temperatur
- PLUS 2 (Guardian NN 2): Freies Chlor 2 ppm und Temperatur
- PLUS 3 (Guardian NN 3): Freies Chlor 10ppm, pH und Temperatur
- PLUS 4 (Guardian NN 4): pH, Redox und Temperatur
- PLUS 5 (Guardian NN 5): Freies Chlor, pH, Redox und Temperatur
- PLUS 6 (Guardian NN 6): Freies Chlor, pH, Redox, Gebundenes Chlor, Trübung und Temperatur
- PLUS 7 (Guardian NN 7): Freies Chlor, pH, Trübung und Temperatur

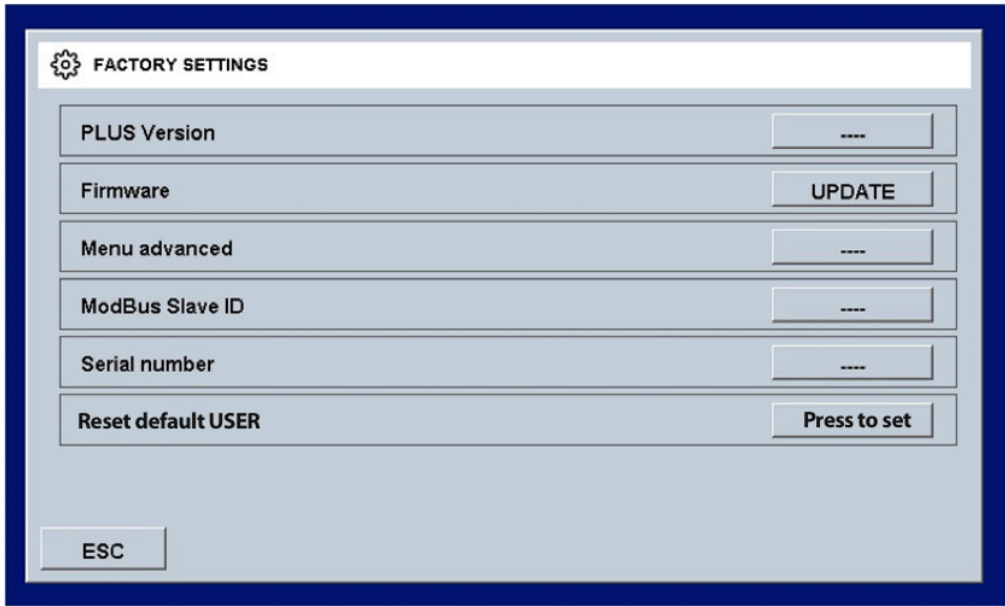
8.2 FIRMWARE

Ermöglicht die Aktualisierung der Firmware: Die Firmware muss sich auf einem USB-Stick befinden, der vor dem Drücken von OK auf der REGISTERKARTE „Zum Starten OK drücken“ eingesteckt werden muss



Abbildung 30 Firmware-Update

8.3 ERWEITERTES MENÜ

Ermöglicht die Einstellung des erweiterten Modus, wobei einige versteckte Menüs des Standardmodus (EIN/AUS) freigegeben werden

8.4 MODBUS SLAVE ID

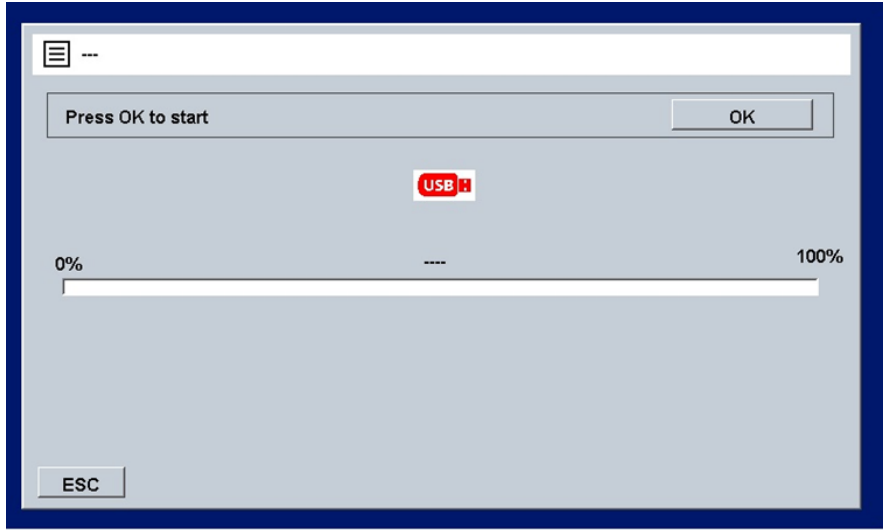
Ermöglicht die Änderung der Slave-ID, indem eine neue eingegeben wird (ID=1 Standard)

8.5 SERIENNUMMER

Ermöglicht die Änderung der Seriennummer des Instruments

8.6 STANDARDBENUTZER ZURÜCKSETZEN

Ermöglicht es, alle Parameter zurückzusetzen und die Werkseinstellungen wieder herzustellen.

8.7 VERBINDUNG ZU FLUIDRA CONNECT

Anschluss an den Connect & Go Schaltschrank

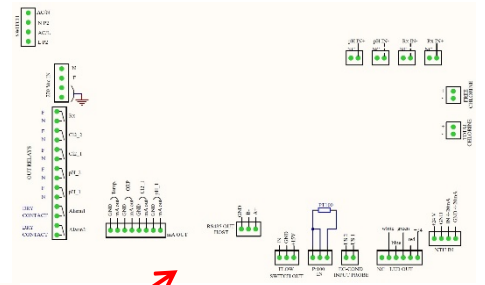
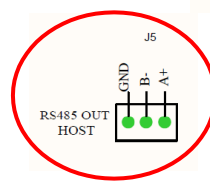
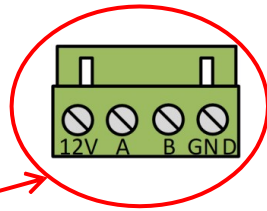

Verbindungen:

Connect & Go	12V	A	B	GND
Guardian Pool	Nicht verwendet	A+	B-	GND

Verbindung zu Connect Box

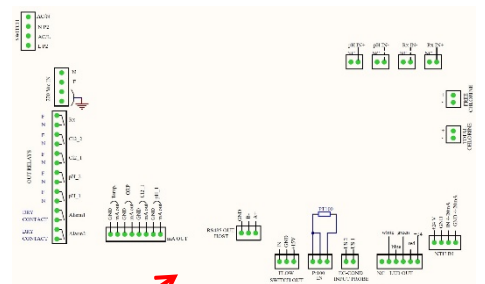
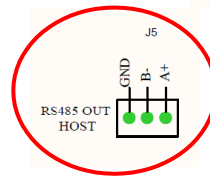
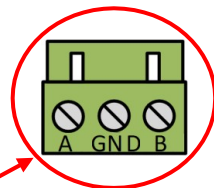
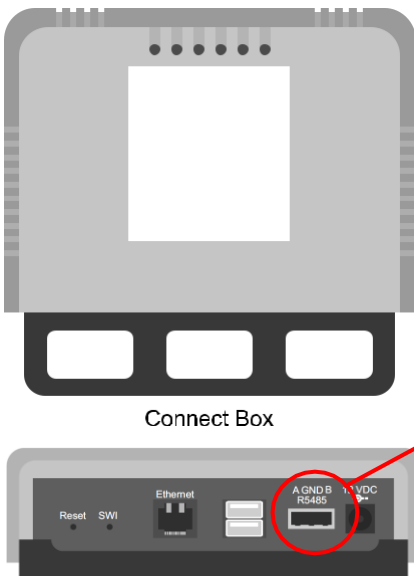

Verbindungen:

Connect Box	A	B	GND
Guardian Pool	A+	B-	GND

MULTIPARAMÉTRICOS FLUIDRA

SISTEMAS GUARDIAN Pool_NN

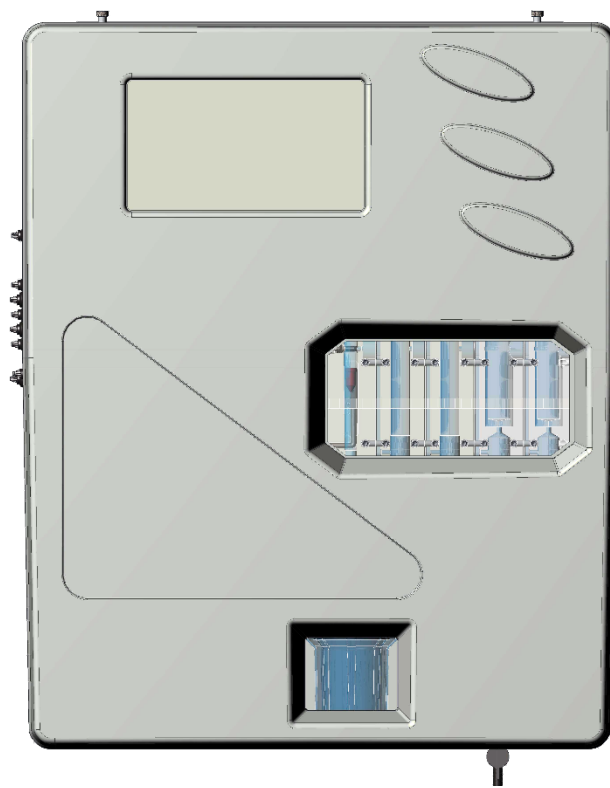

MANUAL DE USUARIO

ÍNDICE

1	GENERALIDADES	4
1.1	LÍMITES DE USO Y PRECAUCIONES DE SEGURIDAD	4
1.1.1	SEGURIDAD ELÉCTRICA	4
1.2	SÍMBOLO DE PRECAUCIÓN	4
1.2.1	ATENCIÓN ESPECIAL A LOS COMPONENTES CRÍTICOS	5
1.2.2	SEGURIDAD EN EL LUGAR DE TRABAJO	5
1.3	CARACTERÍSTICAS TÉCNICAS PRINCIPALES	6
1.3.1	CARACTERÍSTICAS TÉCNICAS	7
2	DESCRIPCIÓN GENERAL	8
3	PROGRAMACIÓN	9
3.1	PANTALLA PRINCIPAL	9
3.1.1	AJUSTES GENERALES	9
3.1.2	AJUSTES DE FÁBRICA	11
3.1.3	CAUDAL	11
3.1.4	WI-FI	12
3.1.5	FECHA Y HORA	12
3.2	MEDIDAS	13
3.2.1	PUNTO DE AJUSTE	14
3.2.2	CALIBRACIÓN	17
3.2.3	GRÁFICOS	18
3.2.4	VALORES DE ALARMA	18
3.2.5	NOMBRE DE LA MEDIDA	18
3.2.6	PRIMERA CALIBRACIÓN	18
3.2.7	INTERVALO	18
4	INSTALACIÓN	19
4.1	KIT DE INSTALACIÓN	19
4.2	MONTAJE EN LA PARED	20
4.3	BLOQUE TERMINAL DE CONEXIÓN	21
4.4	CONEXIONES ELÉCTRICAS	24
4.5	CONEXIONES HIDRÁULICAS	24
4.6	CONEXIÓN DE SONDAS	25
4.6.1	CONEXIÓN DE Sonda REDOX Y pH	25
4.6.2	CONEXIÓN DE Sonda DE CONDUCTIVIDAD	25
4.6.3	CONEXIÓN DE Sonda DE CLORO	25
4.6.4	CONEXIÓN DE Sonda DE TEMPERATURA	26
5	PUESTA EN MARCHA Y FUNCIONAMIENTO	26
5.1	PUESTA EN MARCHA	26
5.2	OPERACIÓN	26
5.3	REGULACIÓN DEL CAUDAL	27
6	MANTENIMIENTO	28
6.1	LIMPIEZA GENERAL DEL SISTEMA	28
6.2	LIMPIEZA/SUSTITUCIÓN DEL FILTRO DE AGUA	28
6.3	LIMPIEZA DEL ELECTRODO/SONDA	29
6.4	INSPECCIÓN DEL CIRCUITO HIDRÁULICO	29
7	SOLUCIÓN DE PROBLEMAS	30
8	APÉNDICE	31
8.1	Versión PLUS	31

8.2	FIRMWARE.....	32
8.3	MENÚ AVANZADO.....	32
8.4	ID DE ESCLAVO MODBUS	32
8.5	NÚMERO DE SERIE	32
8.6	RESETEAR USUARIO PREDETERMINADO.....	32
8.7	CONEXIÓN A FLUIDRA CONNECT	33

1 GENERALIDADES

1.1 LÍMITES DE USO Y PRECAUCIONES DE SEGURIDAD

Para garantizar la seguridad del operador junto con el correcto funcionamiento del equipo, es importante trabajar dentro de los límites permitidos y adoptar todas las precauciones que se enumeran a continuación:

PRECAUCIÓN



Realice un control antes del uso para asegurarse de que se cumplen todos los requisitos de seguridad. El equipo no debe alimentarse ni conectarse a otro equipo hasta que se cumplan las condiciones de seguridad.

1.1.1 SEGURIDAD ELÉCTRICA

PRECAUCIÓN



Todas las conexiones deben estar aisladas de la tierra ambiental (la masa no está aislada).

NO conecte ninguna de estas conexiones a tierra.

Para garantizar las condiciones de máxima seguridad para el operador, se recomienda que se respeten todas las indicaciones enumeradas en este manual.

- **Alimente el equipo exclusivamente utilizando tensión de red según las especificaciones (100 ÷ 240 Vca/cc 50-60 Hz)**
- **Sustituya inmediatamente las piezas dañadas. Todos los cables, conectores, accesorios u otras partes del equipo que se encuentren dañados o no funcionen correctamente deben sustituirse inmediatamente. En este caso, contacte con el centro de asistencia técnica autorizado más cercano.**
- **Según UL, no conecte en salidas de relé un voltaje superior a 115 V.**

1.2 SÍMBOLO DE PRECAUCIÓN

El símbolo que se muestra a continuación representa el símbolo de **PRECAUCIÓN** y recuerda al operador que debe leer el manual del usuario para obtener información importante, recomendaciones y sugerencias sobre el uso correcto y seguro del equipo.

Este símbolo también se utiliza en el software y en particular, en la pantalla de «medidas», evidenciando un evento que se explicará en la siguiente página de la pantalla.



En particular, cuando se coloca cerca de puntos de conexión a cables y periféricos, el símbolo en cuestión corresponde a la lectura cuidadosa del manual del usuario para obtener instrucciones relacionadas con dichos cables y periféricos y los métodos para una conexión correcta y segura.

En este capítulo se describen los paneles de equipos, con los mandos correspondientes, conexiones, símbolos y etiquetas. Cada símbolo de precaución va acompañado de una explicación detallada de su significado.

1.2.1 ATENCIÓN ESPECIAL A LOS COMPONENTES CRÍTICOS

El instrumento se suministra con una pantalla de cristales líquidos LCD que contiene pequeñas cantidades de materiales tóxicos.

1.2.2 SEGURIDAD EN EL LUGAR DE TRABAJO

El panel está protegido contra la introducción de líquidos. Evite someter el equipo al riesgo de goteo de agua, salpicaduras o inmersión en agua y el uso en entornos en los que dichos riesgos puedan estar presentes. Los equipos en los que puedan haber penetrado líquidos accidentalmente deben ser apagados, limpiados y controlados inmediatamente por personal autorizado y cualificado.

Una vez realizada la programación, se recomienda cerrar el panel transparente.

Protección:

- con un panel transparente cerrado IP65 EN60529
- con un panel transparente abierto IP54
- EMI /RFI CEI EN55011 - 05/99
- Utilice el equipo dentro de los límites ambientales de temperatura, humedad y presión especificados.

El instrumento ha sido diseñado para funcionar en las siguientes condiciones ambientales:

- Temperatura en el lugar de trabajo: $-0\text{ °C} \div +50\text{ °C}$
- Temperatura de almacenamiento y transporte: $-10\text{ °C} \div +50\text{ °C}$
- Humedad relativa: $10\% \div 95\% \text{ HR} - \text{sin condensación}$

PRECAUCIÓN



La planta de tratamiento de agua en la que se introduzca el instrumento deberá desarrollarse de acuerdo con los requisitos funcionales que impone la legislación vigente.

El aparato debe implementarse perfectamente en la planta.

La planta debe mantenerse operativa en pleno cumplimiento de las normas de seguridad previstas.

Los parámetros indicados en la caja del equipo de control del analizador deben cumplir con la normativa vigente.

Cualquier señal de avería del dispositivo debe colocarse en un entorno controlado constantemente por personal operativo o asistentes de planta.

El incumplimiento de una sola de estas condiciones puede provocar que la «lógica» del dispositivo funcione de una manera potencialmente peligrosa para los usuarios del servicio.

Por ello, se recomienda que el personal de servicio y/o mantenimiento intervenga con sumo cuidado, señalando de forma inmediata cualquier cambio en los parámetros de seguridad, para evitar la creación de situaciones potencialmente peligrosas.

Dado que las consideraciones indicadas anteriormente no pueden ser controladas por el producto en cuestión, el fabricante no se hace responsable de los daños que estas averías puedan causar a personas o cosas.

1.3 CARACTERÍSTICAS TÉCNICAS PRINCIPALES

- Medición simultánea de: cloro libre, pH, redox y temperatura (Opcional: cloro total, cloro combinado)
- **Programación:** a través del teclado con 4 teclas de burbuja
- LCD STN 240x128 retroiluminado
- Registrador de datos interno Flash 4 Mbit de almacenamiento equivalente a 16000 registros con posibilidad de visualizar mediante tablas y gráficos la tendencia de la medición con la indicación de valores mínimo, máximo y promedio del período
 - **Intervalo de registro:** 00:00 ÷ 99:99 min
 - **Tipo:** circular/relleno
 - **Visualización:** tabla/gráfico
- **Regulación P.I.D. para salida de pH**
- **Salida serial RS485:** protocolo MODBUS RTU con velocidad programable 1200 ÷ 38400 velocidad de baudios, para configuración, condición de tiempo real o descarga de datos
- 4 salidas analógicas:
 - **Cantidad:** ppm Cl₂, pH, Redox, Temperatura.
 - **Tipo:** 0.00 / 4.00 ÷ 20.00 mA aislado galvánicamente
 - **Límite de programación:** inferior/superior/inversión
 - **Carga máx.:** 500 Ohm
- Alarma de salida según NAMUR 2,4 mA (con intervalo 4/20 mA)
- 2 Salidas de relé de alarma (falta de agua de muestra, agotamiento de reactivos, proyector quemado, celda sucia)
- 2 Salidas de relé del punto de ajuste 2 para la medición de cloro
- 2 Salidas de relé del punto de ajuste 2 para la medición de pH
- 1 Salida de relé del punto de ajuste 2 para la medición Redox
- 1 Salida de relé del punto de ajuste 2 para la medición de temperatura (pero también del cloro total o combinado, bajo pedido)

Características principales del hardware del dispositivo

- La estructura hardware de esta periferia se basa en la adopción de CPU CMOS de 16 bits extremadamente novedosas, desarrolladas específicamente para la ejecución de las denominadas aplicaciones «embebidas».
- La tarjeta utiliza una EEPROM para almacenar los datos de configuración y las memorias flash para el almacenamiento de los archivos de datos históricos y los archivos de registro de eventos.
- La tarjeta tiene 1 puerto RS485 (optoaislado) para redes locales que se utiliza para conexiones con dispositivos de comunicación local (ordenador de configuración, terminales y controles remotos, etc.).
- La tarjeta integra un Reloj de Tiempo Real (reloj con fecha) que permite al software almacenar cifras en orden cronológico.

1.3.1 CARACTERÍSTICAS TÉCNICAS

Unidad de potencia multiparamétrica para la determinación de:
Cloro libre, cloro total, pH, Redox, temperatura y turbidez

Parámetro	Intervalo	Resolución	Fiabilidad
Cloro Libre	00.00 ÷ 02.00 ppm o 10.00 ppm Cl ₂	0.01 ppm	1% f.s.
Cloro total	00.00 ÷ 10.00 ppm Cl ₂	0.01 ppm	1% f.s.
pH	00.00 ÷ 14.00 pH	0,01 pH	1% f.s.
Redox	±1000 mV	1 mV	1% f.s.
Temperatura	00.0 ÷ 65.0 °C	0.1 °C	1% f.s.
Pantalla gráfica	TFT 7" táctil resistiva retroiluminada. Visualización simultánea de valores de medición, estado de salidas digitales, estado de almacenamiento, averías. Programación táctil		
Registrador de datos interno	Flash 32 Mbit Intervalo de registro: 00:00 ÷ 99:99 min Tipo: circular/relleno Visualización: tabla/gráfico		
4 salidas analógicas	ppm Cl ₂ , ppm Cl _{tot} , pH, temperatura Tipo: 0.00 / 4.00 ÷ 20.00 mA aislado galvánicamente Límite de programación: inferior/superior/inversión Carga máx.: 500 Ohm Regulación P.I.D.		
5 salidas de relé del punto de ajuste	N.º 2 para Cloro + 2 para pH + 1 para Redox Punto de ajuste con histéresis: 00.00 ÷ 05.00 ppm Cl ₂ / 00.00 ÷ 14.00 pH / ± 1500 mV Programación de histéresis Relé de carga resistiva máxima 6 A a 250 Vca		
2 salidas de relé de alarma	ON-OFF acumulativo para: Mín./Máx., punto de ajuste Relés de carga resistiva máxima 6 A a 250 Vca		
Entrada digital	Para sensor de flujo		
Salida serial RS485	Protocolo MODBUS RTU con velocidad programable 1200 ÷ 38400 velocidad de baudios, para configuración, condición de tiempo real o descarga de datos		
Condiciones de funcionamiento	Temperatura de funcionamiento: 0÷50 °C Temperatura de almacenamiento y transporte: -25÷65 °C Humedad 10-95% sin condensación		
Fuente de alimentación/ Protección eléctrica	Fuente de alimentación: 90÷260 Vca/cc 50-60 Hz Absorción media: 30 W Protección eléctrica:		
Carcasa	Carcasa de placa única de ABS		

2 DESCRIPCIÓN GENERAL

La serie del panel Guardian **Pool_NN** incluye los siguientes modelos:

N.º	Modelo	Código	Descripción
1	Guardian Pool_NN 1 Cloro libre 10 ppm	72700	Con sensor de cloro orgánico ⁽²⁾ 0-10 ppm Temperatura
2	Guardian Pool_NN 2 Agua potable Cloro libre 2 ppm	72701	Con sensor de cloro orgánico ⁽²⁾ 0-2 ppm Temperatura
3	Guardian Pool_NN 3 pH y cloro libre	- 72702	- pH - Cloro orgánico libre ⁽²⁾ 0-10 ppm Temperatura
4	Guardian Pool_NN 4 pH – ORP	- 72703	- pH - Sensor ORP, en electrodo dorado (Sensorex) Temperatura
5	Guardian Pool_NN 5 pH – ORP – cloro libre	- 72704	- pH - Sensor ORP, en electrodo dorado (Sensorex) - Cloro orgánico libre ⁽²⁾ Temperatura
6	Guardian Pool_NN 6 pH, ORP, cloro libre, cloro total, cloro combinado, turbidez Entrada para NTU (4- 20 mA)	- 72705	- pH - Sensor ORP, en electrodo dorado (Sensorex) - Cloro Libre - Cloro total - Sensor de turbidez Temperatura
7	Guardian Pool_NN 7 pH, cloro libre, Entrada para NTU (4- 20 mA)	- 77720	- pH - Cloro Libre - Sensor de turbidez Temperatura

NOTAS:

(¹) En la versión ppm, con conversión a **Bromuro** (factor de conversión 2,4) en el equipo real, el cliente puede seleccionar la lectura de Cloro o Bromuro.

(²) Este sensor puede leer **NaClO** (hipoclorito de sodio), **Ca(ClO)₂** (hipoclorito de calcio), **Cl₂** (cloro gaseoso), cloro generado electrolíticamente y cloro orgánico combinado basado en ácido iso-cianúrico (probado hasta una concentración de ácido iso-cianúrico de 500 mg/l).

3 PROGRAMACIÓN

Este manual contiene toda la información para utilizar la pantalla del instrumento. Se analizarán todas las ventanas operativas, con fotos y explicaciones.

3.1 PANTALLA PRINCIPAL



Figura 1 Pantalla principal

3.1.1 AJUSTES GENERALES

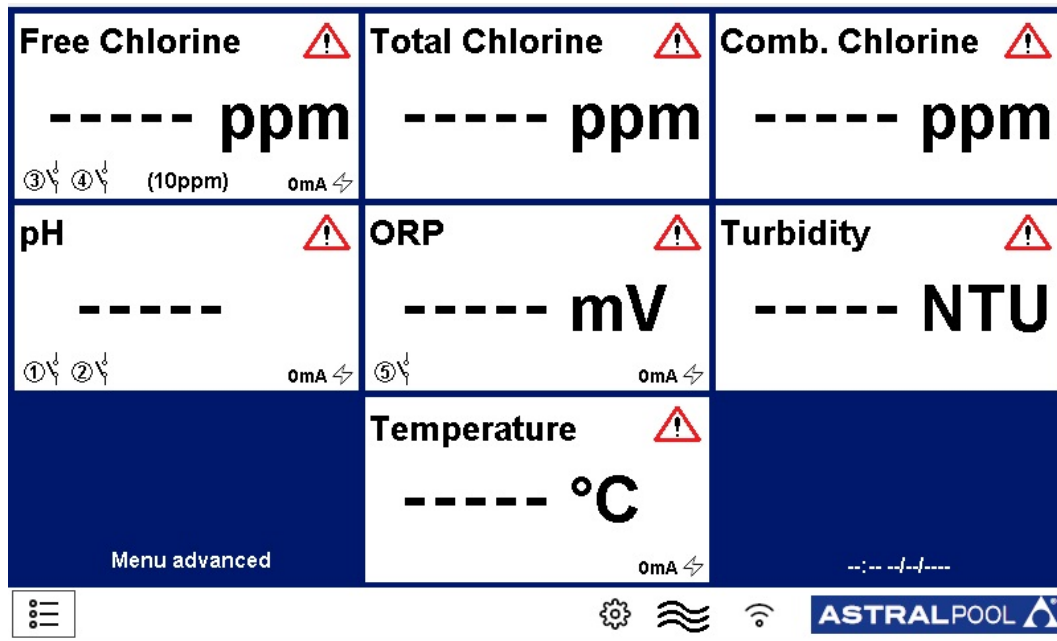
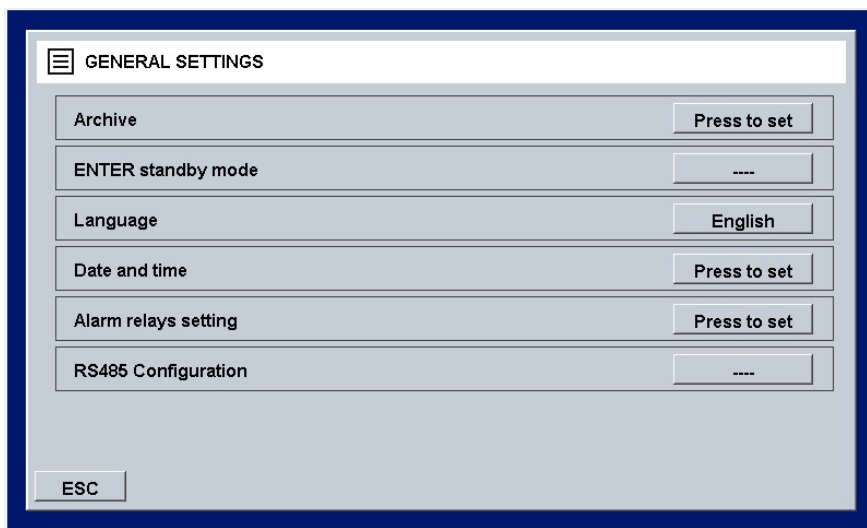

Figure 2 Ajustes generales

- **Archivo:** cómo guardar los datos
 - **PASO:** Elija la frecuencia con la que el sistema toma datos (minutos).
 - **TIPO:** Decida el tipo de archivo de datos:
 - **Círculo:** Toma datos en modo FIFO.
 - **Lleno:** Toma datos hasta que esté lleno. Entonces requiere estar vacío.
 - **Restablecer:** Restablece los datos guardados.
 - **Guardar en pendrive:** El sistema guarda los datos en el puerto USB.
 - **Ver registro: Muestra los datos archivados.**
 - **Registro de alarmas: Muestra el historial de alarmas.**



Figura 3 Ajuste de archivos

- **ENTRAR en el modo de espera**
El sistema entra en reposo, el sistema mide, pero no realiza dosificaciones ni comandos.
- **Idioma**
Ajuste del idioma operativo (inglés).
- **Fecha y hora:**
Ajuste de la fecha y la hora que se visualiza en la ventana principal.

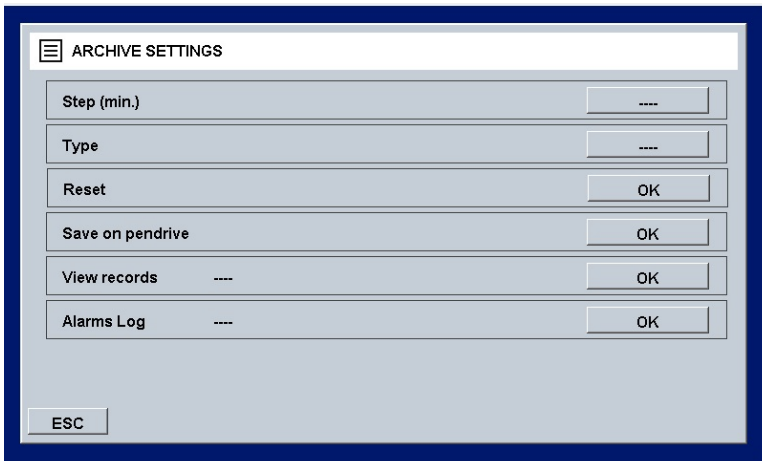

Figura 4 Fecha y hora

- **Ajuste de los relés de alarma**

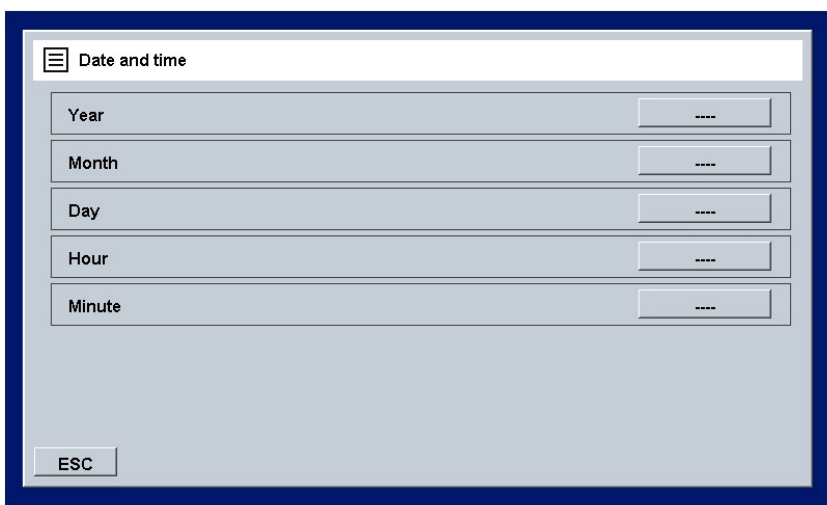

Figura 5 Fecha y hora

Hay dos relés de alarma y son asignables:

- **ASIGNACIÓN DEL RELÉ DE ALARMA:** Elija la medida a la que asignar el relé; es posible elegir entre: todas las medidas, Combine Cloro Setpoint o Turbidity Setpoint
- **ESTADO DEL RELÉ DE ALARMA:** Permite elegir el estado normal del relé:
NO (Abierto Normal)
NC (Cerrado Normal)
- **RETARDO DEL RELÉ DE ALARMA (s):** Elija el tiempo (segundos) después del cual el relé cambia su estado.

3.1.2 AJUSTES DE FÁBRICA

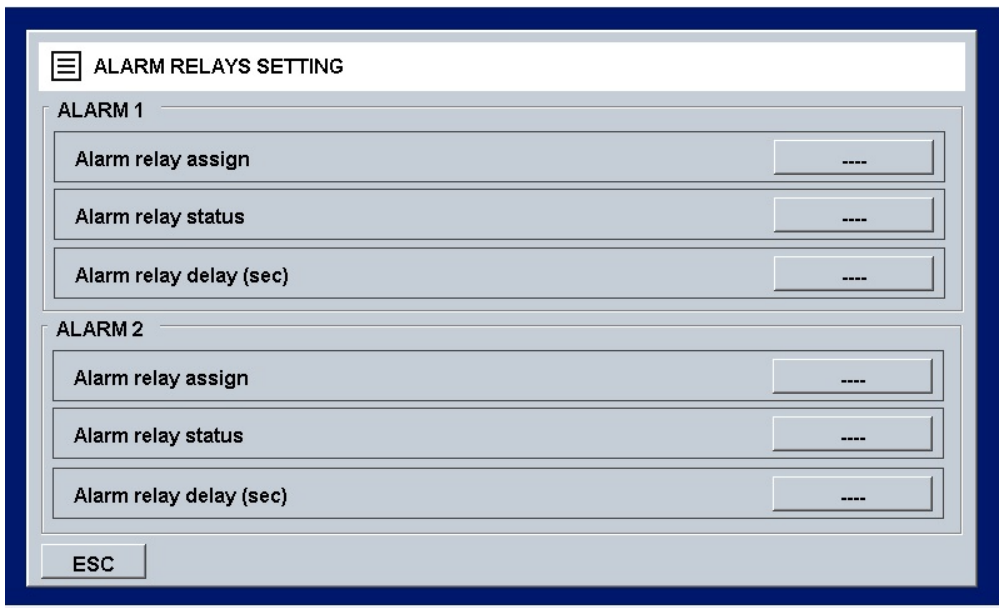
Esta ventana está protegida por contraseña. La explicación se encuentra en el apéndice.

3.1.3 CAUDAL

Hay dos estados:

 - ON: cuando hay caudal.

 - OFF: cuando no hay caudal.

3.1.4 WI-FI

Este icono muestra si hay una conexión LAN Wi-Fi.

Para conectarse a la red LAN Wi-Fi, siga los pasos a continuación:

- 1) Conéctese al wi-fi SSID-XXXX con un teléfono u ordenador; la contraseña de la red es:
1234567890
- 2) Inicie un navegador y conéctese a la dirección: **192.168.4.1** y use los siguientes datos para iniciar sesión:
 - Nombre de usuario: **admin**
 - Contraseña: **0000**
- 3) Cuando esté conectado, asegúrese de que, en la parte superior izquierda del tablero, junto a **Up since_**, aparece la fecha y la hora en que se ha encendido la tarjeta



Figura 6 Menú de punto de ajuste

3.1.5 FECHA Y HORA

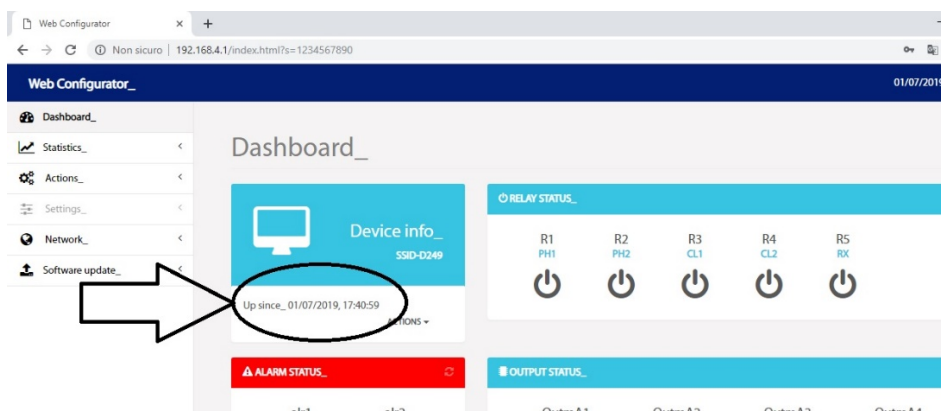

Muestra la fecha y la hora que se están configurando en la ventana del menú.

3.2 MEDIDAS



Figura 7 Ventana principal

Cuando se toca la pestaña de la medida en la ventana principal, se abre (Figura 7):

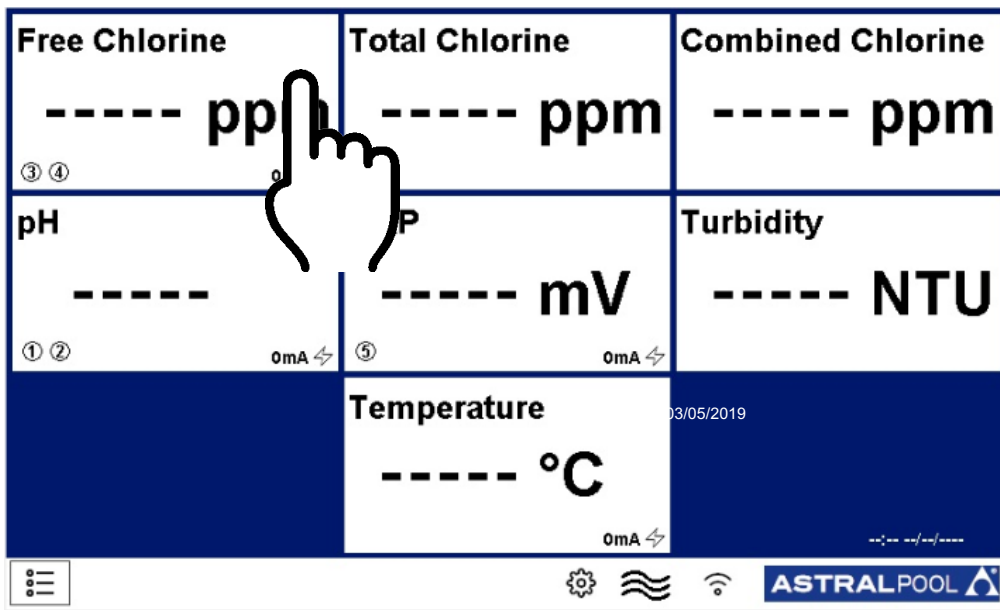

Figura 8 Menú de medidas

Esta ventana es la misma para todas las medidas.

3.2.1 PUNTO DE AJUSTE

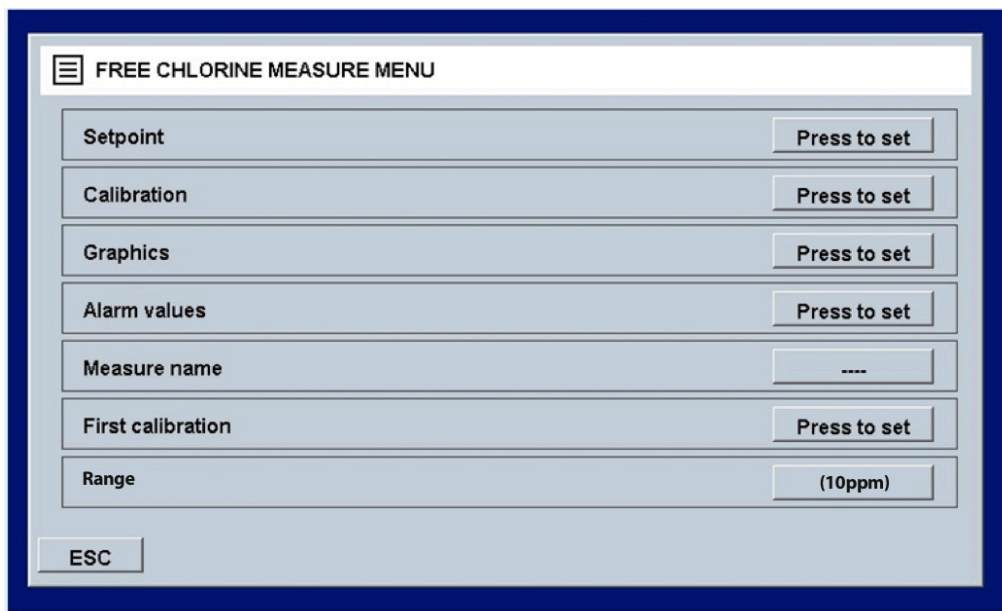
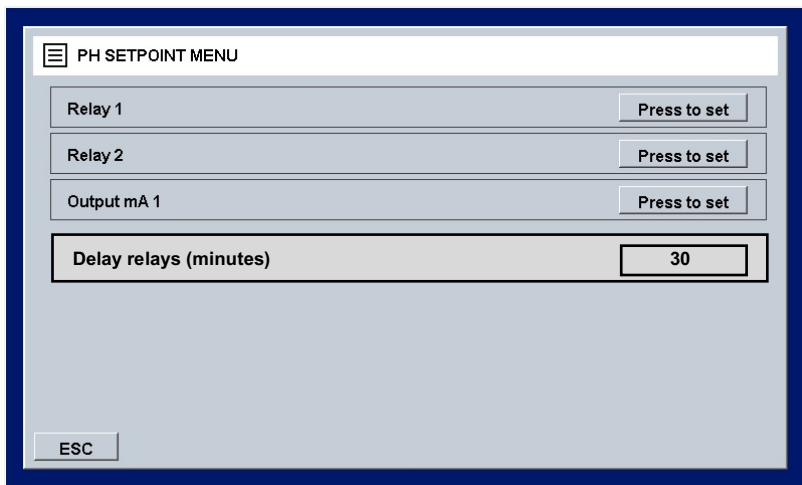

Nota:

el menú "relés de retardo" sólo afecta a los relés 3 y 4 del cloro libre, se activa al encender el instrumento, tiene la función de esperar un tiempo de polarización de la sonda de cloro libre, se muestra un reloj de arena en la pantalla principal. 

Figura 9 Menú de punto de ajuste

- **Relés**

El número del relé que se puede utilizar es diferente para las medidas:

- **Relé n.º 1, 2 pH**
- **Relé n.º 3, 4 cloro libre**
- **Relé n.º 5 Rx**



Figura 10 Menú de punto de ajuste del relé

Son las ventanas dedicadas para transmitir:

VALOR DE AJUSTE: Establecer el valor del punto de ajuste en ppm

HISTÉRESIS: Establece el intervalo alrededor del punto de ajuste (la histéresis del punto de ajuste es el intervalo)

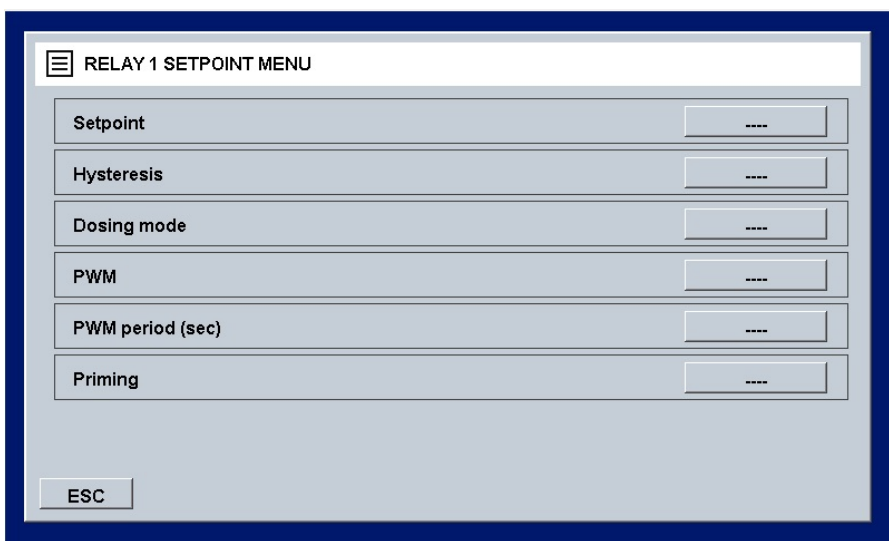
MODOS DE DOSIFICACIÓN: Establecer el modo Relé:

- **ALTO:** El relé se cierra cuando las medidas son inferiores al punto de ajuste \pm histéresis, y se abre cuando la medida es superior al punto de ajuste \pm histéresis
- **BAJO:** El relé se abre cuando las medidas son inferiores al punto de ajuste \pm histéresis, y se cierra cuando la medida es superior al punto de ajuste \pm histéresis

Cebado: Es posible activar manualmente las bombas dosificadoras relacionadas con los productos.

Ejemplos ALTO/BAJO:

Dosing mode: HIGH



Figura 1 Menú de punto de ajuste del relé

Es la opción para aumentar el valor de la medición cuando cae por debajo de un valor elegido. El relé se cierra si el valor de la medida está por debajo del mínimo del intervalo y se abre cuando vuelve al máximo del intervalo.

Dosing mode: LOW

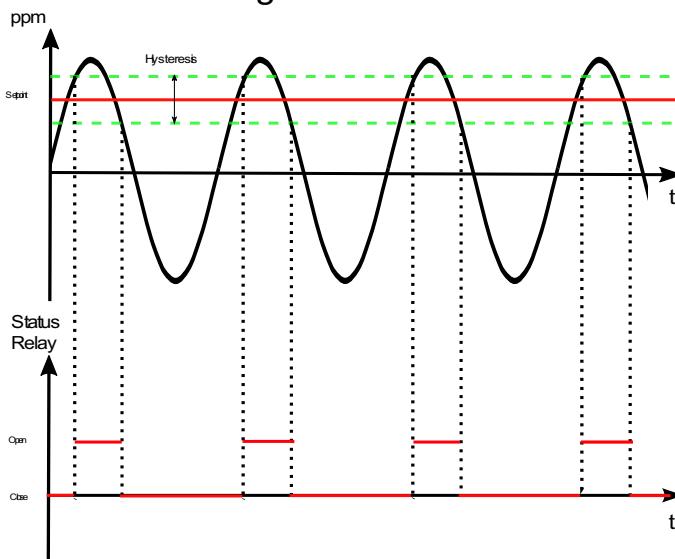

Figura 2 Menú de punto de ajuste del relé

Es la opción para disminuir el valor de la medición cuando sube por encima de un valor elegido. El relé se cierra si el valor de la medida está por debajo del máximo del intervalo y se abre cuando vuelve al mínimo del intervalo.

- **SALIDA mA**

El número de mA de salida que se puede utilizar es diferente para las medidas:

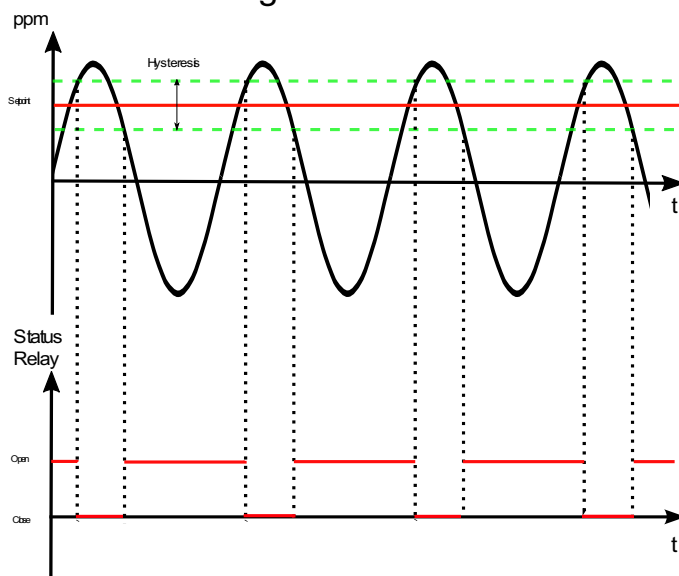
- **Salida mA 1 pH**
- **Salida mA 2 cloro libre**
- **Salida mA 3 Rx**
- **Salida mA 4 Temperatura**

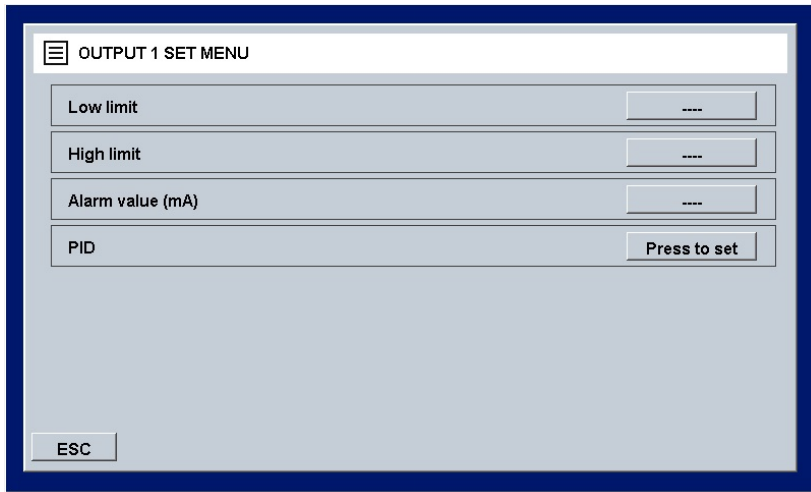

Figure 53 Menú de configuración de salida

Es la ventana reservada a la salida mA:

Límite BAJO: Establece el valor mínimo de la salida.

Límite ALTO: Establece el valor máximo de la salida.

Valor de alarma (mA): Establece el valor que, si se supera, genera una alarma.

PID: Presione para abrir la ventana del PID.



Figura 14 Menú de configuración de PID

PID: PID habilitado en la salida (ON/OFF).

Punto de ajuste del PID: Establece el punto de ajuste del PID.

Algoritmo PID: Establece el tipo de PID (P/I/D).

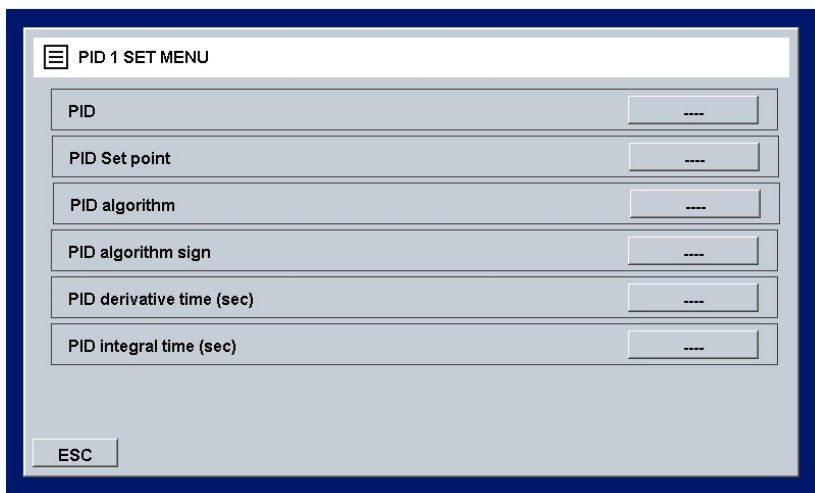
Signo del algoritmo PID: Establece el tipo de control (directo/inverso).

- **Valor máximo lógico / Valor mínimo lógico**

Si la histéresis no está presente, se pueden establecer los límites superior e inferior; si la medida supera estos valores, se genera una alarma.

3.2.2 CALIBRACIÓN



Figura 15 Calibración

Esta pestaña muestra el método de calibración para las mediciones; siga las instrucciones en la pantalla: Inserte la sonda en la solución tampón, espere a que la medida sea estable (en las áreas rodeadas por un círculo), y luego presione OK. Se abrirá la siguiente ventana:

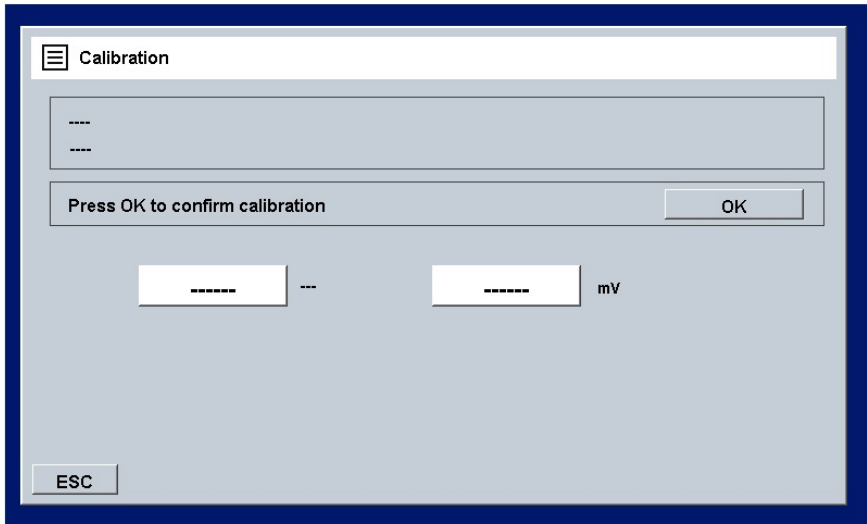

Figura 66 Configurar valor

Configure el valor de la solución tampón y presione OK.

Solo el pH requiere una calibración de 2 puntos (con soluciones tampón de pH 4 y pH 7): Cuando se presiona «Calibrar», se abre la ventana de las otras calibraciones.

3.2.3 GRÁFICOS

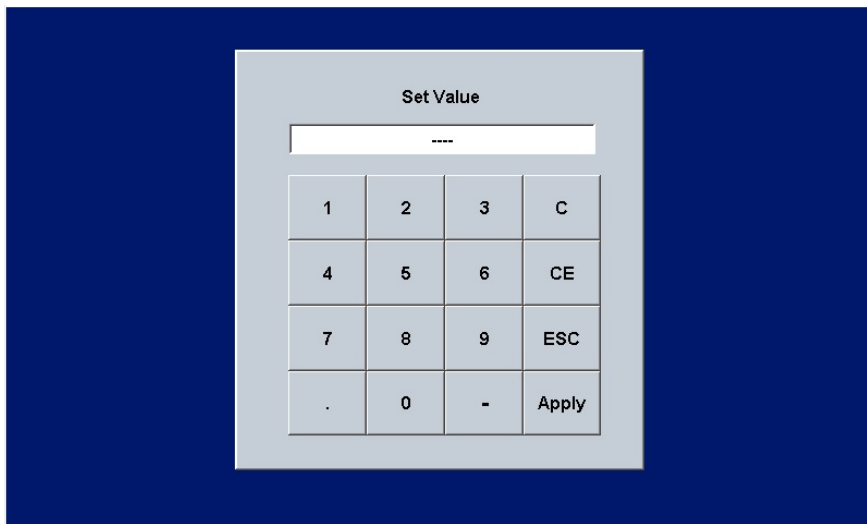

Figura 7 Menú de gráficos

- **Valor mínimo en el diagrama:** establezca el valor mínimo en el gráfico
- **Valor máximo en el diagrama:** establezca el valor máximo en el gráfico
- **Ajuste de tiempo del gráfico:** establezca los ejes de tiempo
- **Gráficos:** presione para visualizar el gráfico (figura 18)

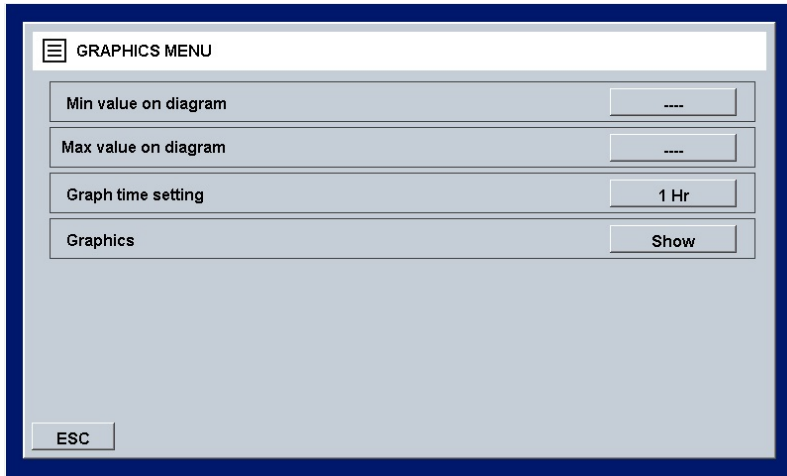

Figura 8 Gráfico

3.2.4 VALORES DE ALARMA

Establece el valor máximo / mínimo, por encima / por debajo del cual se activa la alarma.

3.2.5 NOMBRE DE LA MEDIDA

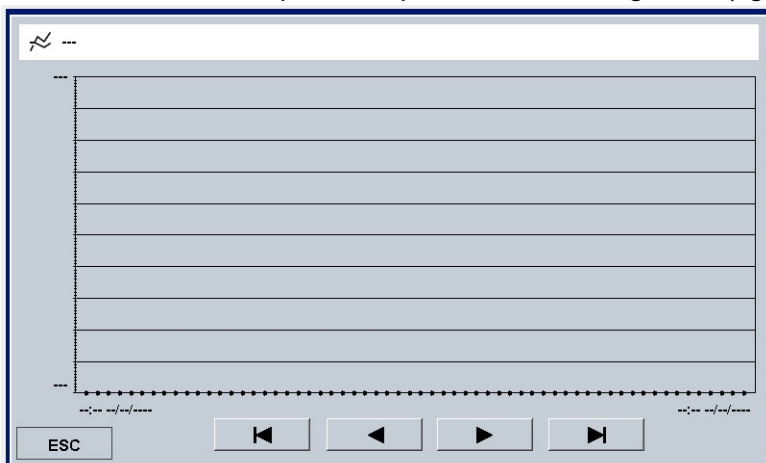
Permite modificar el nombre de la medida en esa pestaña.

3.2.6 PRIMERA CALIBRACIÓN

Realice la primera calibración solo después de esperar 90 minutos.

3.2.7 INTERVALO

Establece el intervalo de medida de funcionamiento de la sonda.

4 INSTALACIÓN

Antes de instalar el **multiparámetro AstralPOOL**, lea atentamente lo siguiente. Esta sección describe los pasos para instalar el equipo y el cableado eléctrico. Siga estas indicaciones durante la instalación.

- Asegúrese de que el equipo y todos los dispositivos relacionados estén apagados antes de comenzar a trabajar.
- Si encuentra anomalías o señales de advertencia, deténgase inmediatamente. Comience a trabajar de nuevo solamente cuando haya eliminado la causa del problema.
- No instale el equipo en lugares peligrosos o en áreas con riesgo de incendio o explosión.
- Evite los peligros eléctricos. Nunca utilice equipos dañados o defectuosos.

4.1 KIT DE INSTALACIÓN

	 1: Tornillos de fijación (φ=tornillos de 6 mm)	 2: Tubo de cristal de PVC 8x12 (4 m)	 3: Soporte de sonda	 4: Conectores	
	 5: Sonda de cloro libre 2 ppm	 6: Sonda de cloro libre 10 ppm	 7: Sonda de cloro total 10 ppm	 8: Cable para sonda de cloro (1 m)	
	 9: Sonda de pH	 10: Sonda Redox	 11: Soluciones tampón de pH	 12: Solución tampón ORP	
 13: Cartucho de filtro	 14: Sistema de retrolavado	 15: Soporte para sonda de turbidez PSS8	 16: Sonda de turbidez	 17: Sensor de temperatura	 18: Sonda de conductividad y cable

N	Elemento	Pool_NN 1	Pool_NN 2	Pool_NN 3	Pool_NN 4	Pool_NN 5	Pool_NN 6	Pool_NN 7
	Codigo	4						
1	Tornillos de fijación	72700	72701	72702	72703	72704	72705	74720
2	Tubo de PVC 8x12 4 metros	•	•	•	•	•	•	•
3	Soporte de sonda	•	•	•	•	•	•	•
4	Conectores	•	•	•	•	•	•	•
5	Sonda de cloro libre de 2 ppm	•	•	•	•	•	•	•
6	Sonda de cloro libre de 10 ppm		•					
7	Sonda de cloro total de 10 ppm	•		•		•	•	•
8	Cable de cloro 1 metro						•	
9	Sonda de pH	•(x1)	•(x1)	•(x1)		•(x1)	•(x2)	•(x1)
10	Sonda Redox			•	•	•	•	•
11	Solución tampón de pH 7 y pH 4				•	•	•	
12	Solución tampón Redox de 465 mV			•	•	•	•	•
13	Filtro de cartucho de 80 µm				•	•	•	
14	Sistema de retrolavado	•	•	•	•	•	•	•
15	Soporte para sonda de turbidez PSS8	(*1)	(*1)	(*1)	(*1)	(*1)	(*1)	(*1)
16	Sonda de turbidez						•	
17	Sonda de temperatura	(*1)	(*1)	(*1)	(*1)	(*1)	(*1)	
18	Sonda de conductividad y cable	(*1)	(*1)	(*1)	(*1)	(*1)	(*1)	

(*1 bajo pedido).

4.2 MONTAJE EN LA PARED

Instale la unidad de control lejos de fuentes de calor, en un lugar seco, sin salpicaduras de agua y protegida de goteos, a temperaturas inferiores a 40 °C. La temperatura mínima no debe ser inferior de 0 °C.

La unidad de control debe instalarse asegurándose de dejar suficiente espacio para los cables y las conexiones.

El panel trasero de la unidad de control tiene 4 orificios cerca de las esquinas para montar la unidad en la pared. La siguiente figura muestra la posición de los orificios de perforación y las dimensiones máximas del panel.



Figura 9 Montaje en pared del sistema

Si es adecuado para el soporte, utilice los tacos de pared suministrados, en caso contrario elija un tipo adecuado. La unidad se suministra ya montada y cableada internamente.

Para garantizar un soporte óptimo para el sistema, la pared debe ser lo más recta y uniforme posible.

Perfore dos orificios alineados horizontalmente a una altura que permita al operador tener una vista correcta del panel de control y en una posición adecuada para las operaciones de calibración y control.

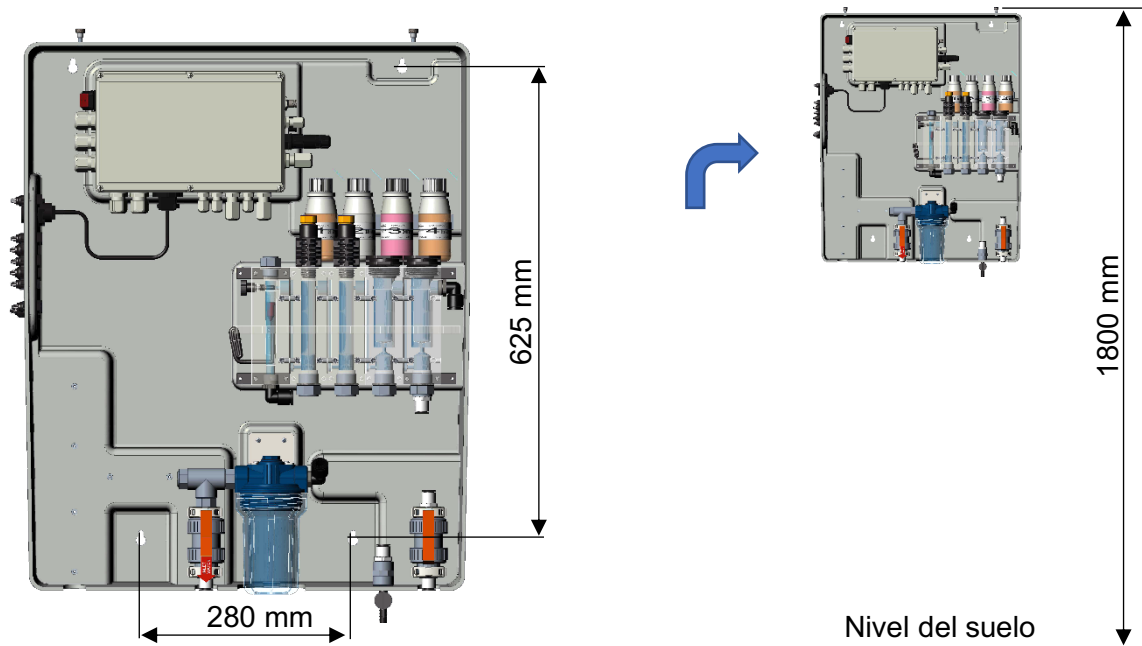
La altura recomendada desde el suelo es de unos 180 cm, o al menos a la altura de los ojos.

La distancia entre los agujeros se indica en la imagen de arriba.

Utilice un nivel de burbuja durante la instalación para nivelar correctamente la unidad de control.

Las dimensiones totales de la caja son: 730x600x230 mm (A x A x P)



Figura 10 Dimensiones del sistema

4.3 BLOQUE TERMINAL DE CONEXIÓN

Antes de instalar el multiparámetro Astralpool, lea atentamente lo siguiente.



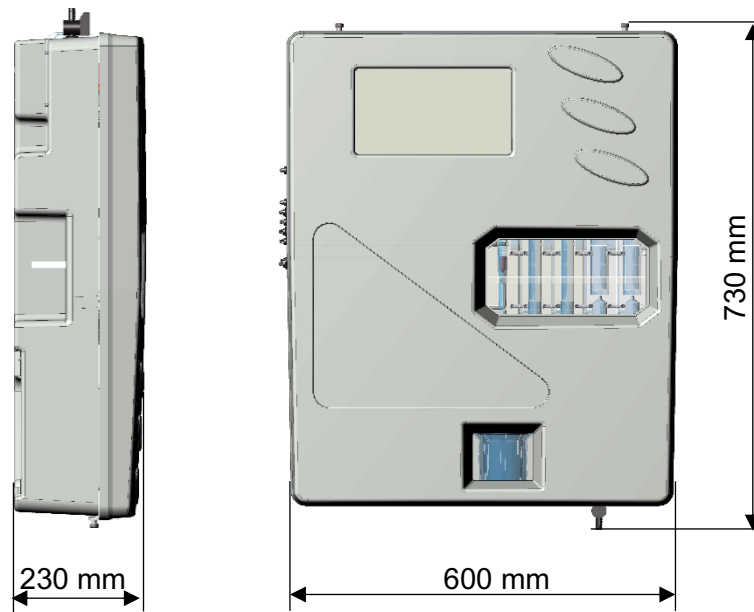







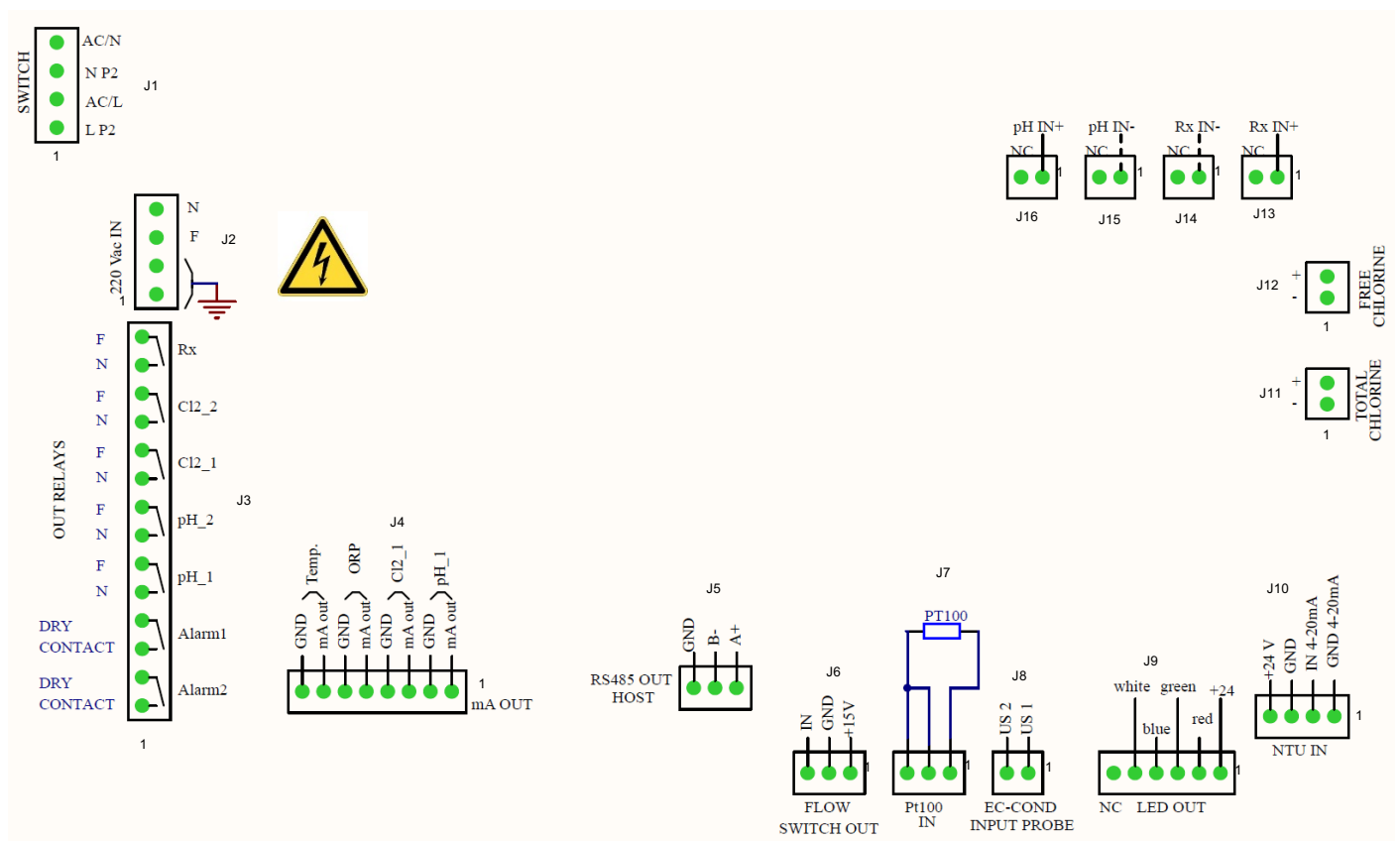
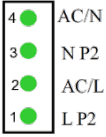
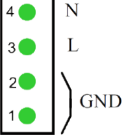













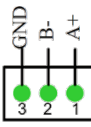
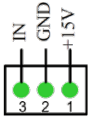

Figura 11 Conexiones

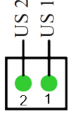
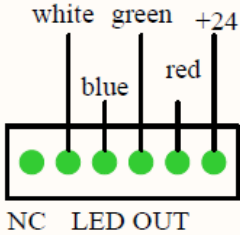
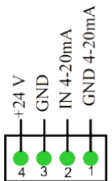
Conector	Terminal	IMAGEN	DESCRIPCIÓN	
J1	1		Cable neutro de la fuente de alimentación CA	
	2		Cable neutro 220 Vca	
	3		Cable de línea de la fuente de alimentación CA	
	4		Cable de línea 220 Vca	
J2	1		Cable de tierra 1	
	2		Cable de tierra 2	
	3		Cable de línea de la fuente de alimentación 220 Vca	
	4		Cable neutro de la fuente de alimentación 220 Vca	
J3	1	ALARMA 2 	Relé de alarma remota (2)	contacto seco
	2		Relé de alarma remota (2)	
	3	ALARMA 1 	Relé de alarma remota (1)	contacto seco
	4		Relé de alarma remota (1)	
	5	pH_1 	Punto de ajuste de pH 1	contacto alimentado (100-240 Vca)
	6		Punto de ajuste de pH 1	
	7	pH_2 	Punto de ajuste de pH 2	contacto alimentado (100-240 Vca)
	8		Punto de ajuste de pH 2	
	9	Cl ₂ _1 	Punto de ajuste de Cl ₂ 1	contacto alimentado (100-240 Vca)
	10		Punto de ajuste de Cl ₂ 1	
	11	Cl ₂ _2 	Punto de ajuste de Cl ₂ 2	contacto alimentado (100-240 Vca)
	12		Punto de ajuste de Cl ₂ 2	
	13	Rx 	Punto de ajuste Rx	contacto alimentado (100-240 Vca)
	14		Punto de ajuste Rx	
J4	1	pH_1 	Cable positivo pH mA	
	2		Cable negativo pH mA	
	3	Cl ₂ _1 	Cable positivo Cl ₂ (1) mA	
	4		Cable negativo Cl ₂ (1) mA	
	5	ORP 	Cable positivo ORP mA	
	6		Cable negativo ORP mA	
	7	Temp 	Cable positivo de temperatura mA	
	8		Cable negativo de temperatura mA	
J5	1		Interfaz RS485 (A+)	
	2		Interfaz RS485 (B-)	
	3		Interfaz RS485 (Tierra)	

(* 1 El relé de alarma se puede configurar en: Alarma de todas las medidas, Punto de ajuste CL combinado; Punto de ajuste de turbidez)

Conector	Terminal	IMAGEN	DESCRIPCIÓN		
J6	1		Cable +15 V		
	2		Cable de tierra		
	3		Cable IN		
J7	1		Cable de conexión PT 100		
	2		Cable de conexión PT 100		
	3		Cable de conexión PT 100		
J8	1		Sonda EC-Cond	Cable 1 μ S	
	2			Cable 2 μ S	
J9	1		+24 V		
	2		Rojo		
	3		Verde		
	4		Azul		
	5		Blanco		
	6		NC		
J10	1		Sonda de turbidez	4-20 mA (Tierra)	
	2			4-20 mA (IN)	
	3			Fuente de alimentación 24 V-	
	4			Fuente de alimentación 24 V+	
J11	1		Sonda de cloro total	Cable negativo Cl_{tot}	
	2			Cable positivo Cl_{tot}	
J12	1		Sonda de cloro libre	Cable negativo Cl_2	
	2			Cable positivo Cl_2	
J13	1		Sonda ORP	RG 174 Rx (IN +)	
	2				
J14	1				RG 174 Rx (IN -)
	2				
J15	1		Sonda de pH	RG 174 pH (IN -)	
	2				
J16	1				RG 174 pH (IN +)
	2				

4.4 CONEXIONES ELÉCTRICAS

Bloque terminal de conexiones:

N	Elemento	Función	Pool_NN 1	Pool_NN 2	Pool_NN 3	Pool_NN 4	Pool_NN 5	Pool_NN 6	Pool_NN 7
		Codigo	72700	72701	72702	72703	72704	72705	74720
1	100-240 Vca 50-60 Hz	Fuente de alimentación	•	•	•	•	•	•	•
2	Relé 1 (pH 1)	Acción de dosis alimentada			•	•	•	•	•
3	Relé 2 (pH 2)	Acción de dosis alimentada			•	•	•	•	•
4	Relé 3 (CL 1)	Acción de dosis alimentada	•	•	•		•	•	•
5	Relé 4 (CL 2)	Acción de dosis alimentada	•	•	•		•	•	•
6	Relé 5 (Rx)	Acción de dosis alimentada				•	•	•	
7	Relé 6 (Alr 1)	Estado de alarma contacto seco	•	•	•	•	•	•	•
8	Relé 7 (Alr 2)	Estado de alarma contacto seco	•	•	•	•	•	•	•
9	mA 1 (pH)	Salida mA			•	•	•	•	•
10	mA 2 (Cl)	Salida mA	•	•	•		•	•	•
11	mA 3 (Rx)	Salida mA				•	•	•	
12	mA 4 (°C)	Salida mA	•	•	•	•	•	•	•
13	Puerto serial RS485	Comunicación	•	•	•	•	•	•	•
14	Entrada Reed	Entrada de estado de caudal	•	•	•	•	•	•	•
15	Sonda de pH	Entrada señal mV			•	•	•	•	•
16	Sonda CL 1	Entrada señal mA	•	•	•		•	•	•
17	Sonda CL 2	Entrada señal mA						•	
18	Sonda de turbidez	Entrada señal mA						•	•
19	Sonda Rx	Entrada señal mV				•	•	•	
20	Sonda temp.	Entrada señal Ohm	•	•	•	•	•	•	•
21	Salida 5 VCC	Fuente de alimentación para luz Led	•	•	•	•	•	•	•
22	Conexión Wi-Fi	Conexión Wi-Fi	•	•	•	•	•	•	•
23	Sonda de conductividad	Entrada señal mV	•	•	•	•	•	•	•

4.5 CONEXIONES HIDRÁULICAS



Figura 12 Conexiones hidráulicas

4.6 CONEXIÓN DE SONDAS

4.6.1 CONEXIÓN DE Sonda REDOX Y pH

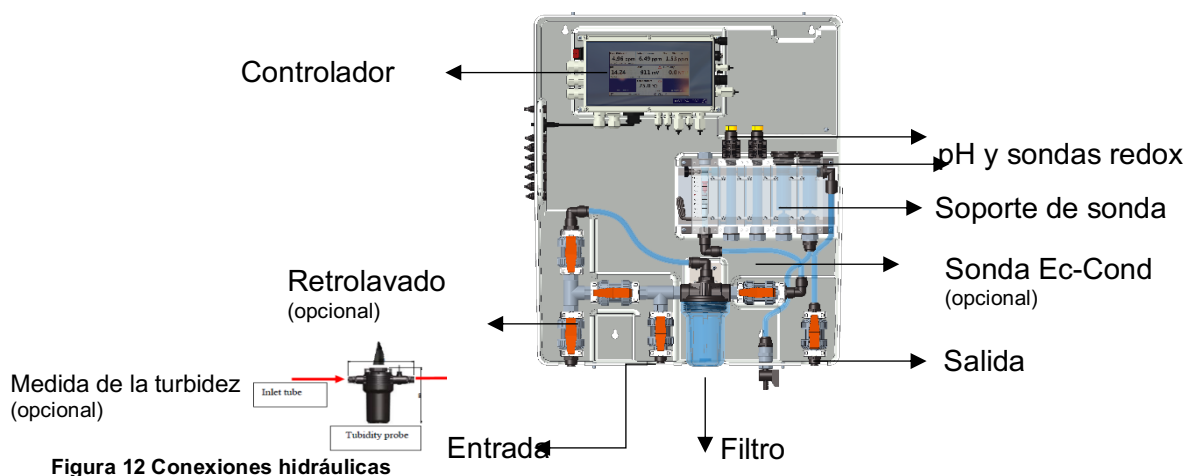

Figura 13 Conectores de pH y Redox

4.6.2 CONEXIÓN DE Sonda DE CONDUCTIVIDAD

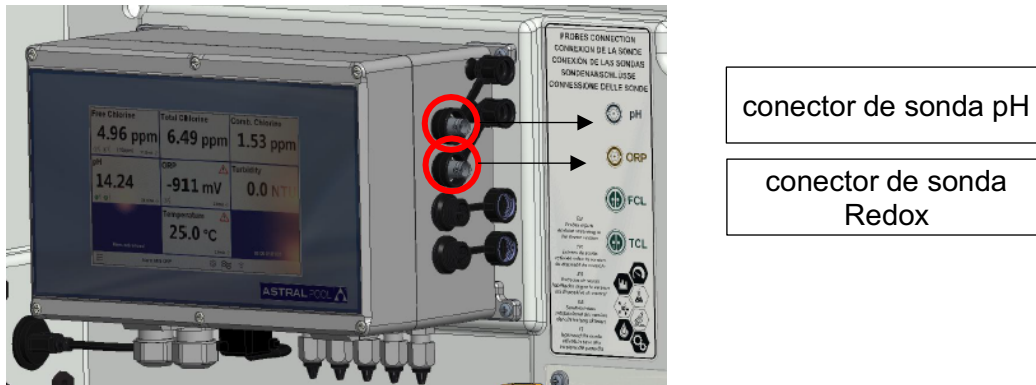

Figura 14 Conector de conductividad

4.6.3 CONEXIÓN DE Sonda DE CLORO

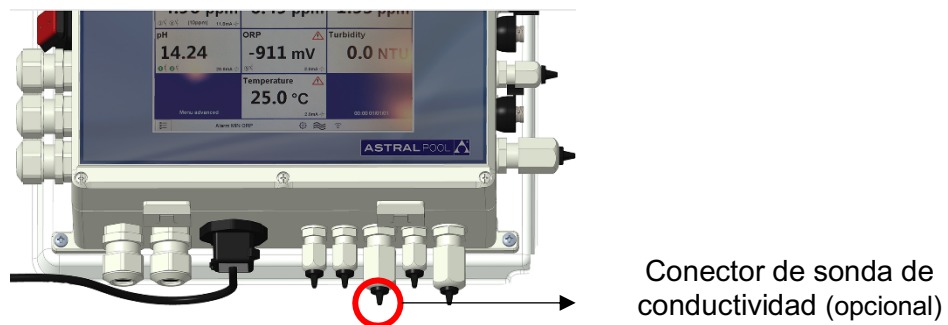
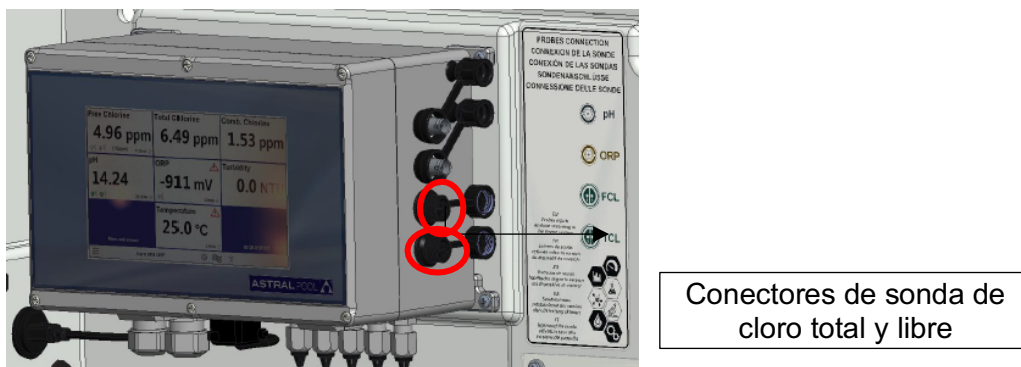

(Nota: por favor, verifique las conexiones de la etiqueta con la conexión de polaridad de las sondas de cloro)

Figura 15 Conectores de cloro

4.6.4 CONEXIÓN DE SONDA DE TEMPERATURA



Figura 16 Conector de temperatura

5 PUESTA EN MARCHA Y FUNCIONAMIENTO

5.1 PUESTA EN MARCHA

Encienda el sistema usando el interruptor de encendido en el lado superior izquierdo del controlador.

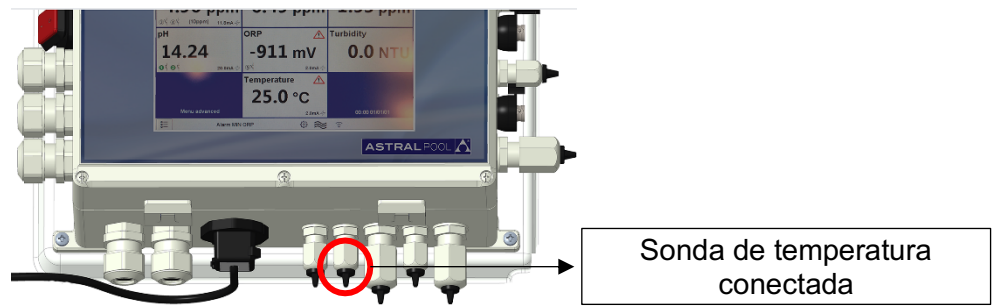

Figura 17 Interruptor de alimentación

5.2 OPERACIÓN

- A: Conecte el tubo de entrada
- B: Conecte el tubo de salida
- C: Abra completamente la regulación de caudal
- D: Desgasifique el aire del filtro

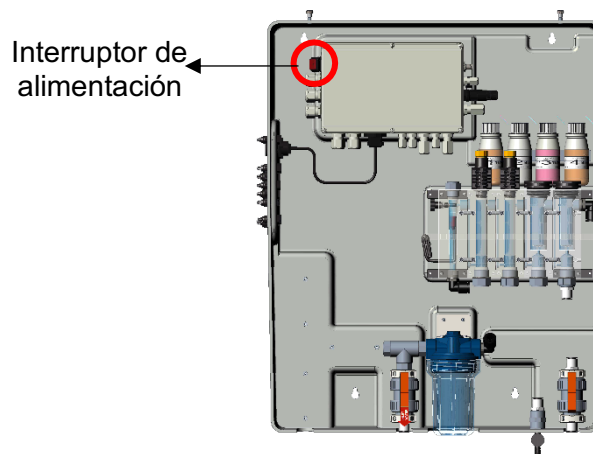
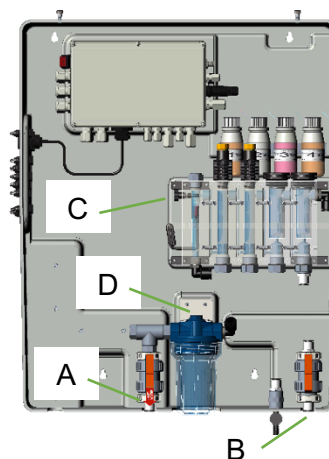

5.3 REGULACIÓN DEL CAUDAL

El caudal de agua debe ajustarse mediante la válvula indicada en la figura siguiente



Figura 18 Grifo de caudal

6 MANTENIMIENTO

Para garantizar siempre un rendimiento óptimo del equipo, se debe realizar un mantenimiento periódico. También recomendamos seguir nuestros programas de mantenimiento.

A continuación, puede encontrar una indicación de los intervalos de mantenimiento máximos:

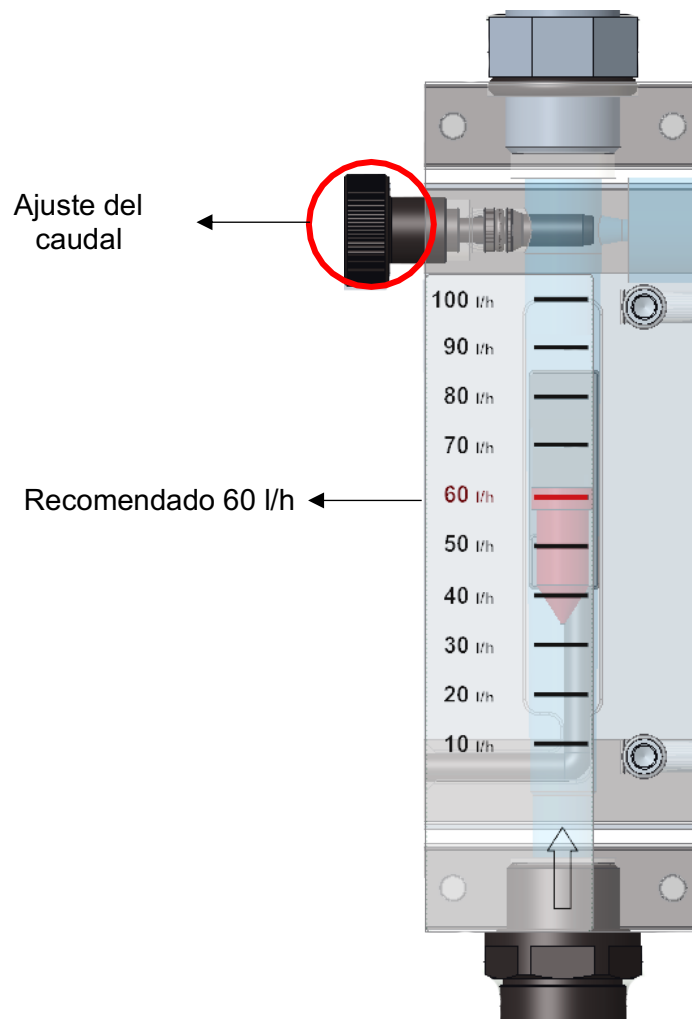
Operación de mantenimiento	INTERVALOS DE TIEMPO			
	1 mes	2 meses	3 meses	6 meses
Limpieza general del sistema				X
Limpieza de la malla del filtro de agua	X			
Inspección del circuito hidráulico		X		
Limpieza de la sonda	De acuerdo con el manual de instrucciones del electrodo/sonda.			

PRECAUCIÓN



Antes de realizar cualquier operación de mantenimiento, apague eléctricamente el equipo presionando el interruptor principal de la línea donde se encuentra el mismo.

PRECAUCIÓN



Antes de realizar cualquier operación de mantenimiento, detenga el caudal de agua que llega al equipo desde el sistema y despresurice abriendo completamente la válvula de muestreo.

6.1 LIMPIEZA GENERAL DEL SISTEMA

Realice esta operación una vez al mes.

Limpie periódicamente todas las superficies del equipo. Utilice únicamente un paño húmedo sin añadir ningún disolvente o producto.

6.2 LIMPIEZA/SUSTITUCIÓN DEL FILTRO DE AGUA

Realice esta operación cada dos meses.

Espere hasta que no salga más agua del circuito hidráulico.

Desenrosque la bandeja de la unidad de filtro y retire el cartucho del filtro del interior; tenga cuidado de no perder las juntas.

Coloque el cartucho bajo el chorro de agua y elimine todos los residuos del filtro con un cepillo suave. Vuelva a montar el cartucho del filtro y la bandeja del filtro en el sistema, teniendo cuidado de volver a colocar las juntas en su lugar, correctamente.

Cierre completamente la válvula de muestreo y restablezca el caudal de agua en el circuito, abriendo las válvulas gradualmente y liberando el aire del sistema. Reactive el sistema eléctricamente y verifique las condiciones de funcionamiento después de haber realizado la prueba inicial.

6.3 LIMPIEZA DEL ELECTRODO/SONDA

Consulte el manual de instrucciones del electrodo/sonda antes de realizar esta operación.

Espere hasta que no salga más agua del circuito hidráulico. Desconecte los cables de los electrodos destornillando los conectores en sus extremos y las abrazaderas de sujeción, luego retírelos del soporte de sondas en el circuito hidráulico del sistema. Lave el extremo sensible con agua tibia y un jabón suave, eliminando los restos de grasa con un pincel de cerdas suaves.

Para limpiar las sondas, no las frote con objetos abrasivos o paños que puedan cargarlas electrostáticamente.

En caso de suciedad extrema, limpie los electrodos con alcohol desnaturalizado. Una vez finalizadas las operaciones de limpieza, vuelva a conectar los electrodos con sus respectivos cables, y calíbrelos sin restablecer el caudal de agua al sistema. Cuando finalice el procedimiento de calibración, apague el sistema eléctricamente y vuelva a colocar los electrodos en el soporte de la sonda. Vuelva a conectar la fuente de alimentación y el caudal de agua al sistema, después de cerrar la válvula de muestreo.

6.4 INSPECCIÓN DEL CIRCUITO HIDRÁULICO

Realice esta operación cada seis meses.

Inspeccione visualmente el circuito hidráulico del equipo después de apagarlo eléctricamente. En presencia de fuga de líquido, daños en la tubería o cualquier problema de sellado, intervenga en el circuito hidráulico solo después de haber interrumpido el caudal de agua que llega a la estación y despresurice el sistema abriendo la válvula de muestreo.

Sustituya las partes dañadas únicamente con repuestos originales o recomendados.

PRECAUCIÓN



No deje impurezas en el interior del circuito hidráulico que puedan obstruirlo.

PRECAUCIÓN



Cierre la válvula de muestreo antes de volver a conectar el caudal de agua al sistema. Restaure la presión del sistema procediendo gradualmente, y luego encienda el equipo.

7 SOLUCIÓN DE PROBLEMAS

Fallos mecánicos	
El caudal dentro de la celda de medición es demasiado bajo	<ul style="list-style-type: none"> Compruebe el sello de las juntas tóricas Compruebe si el filtro está obstruido Compruebe las válvulas de entrada y salida Compruebe la válvula de muestreo
Fallos eléctricos	
Sin señal luminosa, pantalla apagada	<ul style="list-style-type: none"> Compruebe que el equipo esté correctamente alimentado (toma y enchufe). Si el equipo permanece inactivo, póngase en contacto con nuestro Centro de Servicio
Mediciones incorrectas	<ul style="list-style-type: none"> Compruebe la calibración cuidadosamente; en caso de duda, restablezca el instrumento con su configuración predeterminada de fábrica Compruebe que las sondas funcionen correctamente y compruebe su estado de uso

A veces, el líquido puede filtrarse por una conexión suelta o una tuerca anular, o simplemente debido a la ruptura del tubo de suministro de agua. Una vez eliminada la fuga, debe limpiar y secar el agua residual en el sistema, que podría dañar las partes en contacto al estancarse.

8 APÉNDICE

TENGA CUIDADO



Esta PESTAÑA está protegida por contraseña. Se indica en este manual solo para información.

APÉNDICE 1 - AJUSTES DE FÁBRICA



Figura 19 Ajustes de fábrica

8.1 VERSIÓN PLUS

Permite seleccionar el tipo de versión que desea obtener:

- PLUS 1 (Guardian NN 1): Cloro libre 10 ppm y temperatura
- PLUS 2 (Guardian NN 2): Cloro libre 2 ppm y temperatura
- PLUS 3 (Guardian NN 3): Cloro libre 10 ppm, pH y temperatura
- PLUS 4 (Guardian NN 4): pH, Redox y temperatura
- PLUS 5 (Guardian NN 5): cloro libre, pH, redox y temperatura
- PLUS 6 (Guardian NN 6): Cloro libre, pH, Redox, cloro combinado, turbidez y temperatura
- PLUS 7 (Guardian NN 6): Cloro libre, pH, turbidez y temperatura

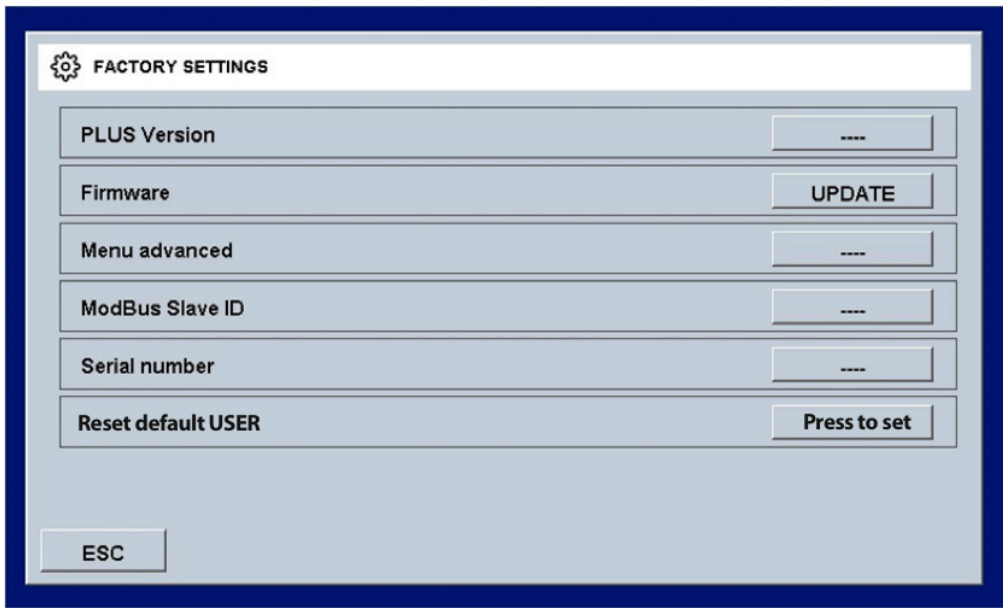
8.2 FIRMWARE

Permite actualizar el firmware: el archivo de firmware debe estar en una memoria USB, que debe insertarse antes de presionar OK en la PESTAÑA «Presionar OK para comenzar»



Figura 30 Actualización de firmware

8.3 MENÚ AVANZADO

Permite configurar el modo avanzado desbloqueando algún menú oculto del modo estándar (ON/OFF)

8.4 ID DE ESCLAVO MODBUS

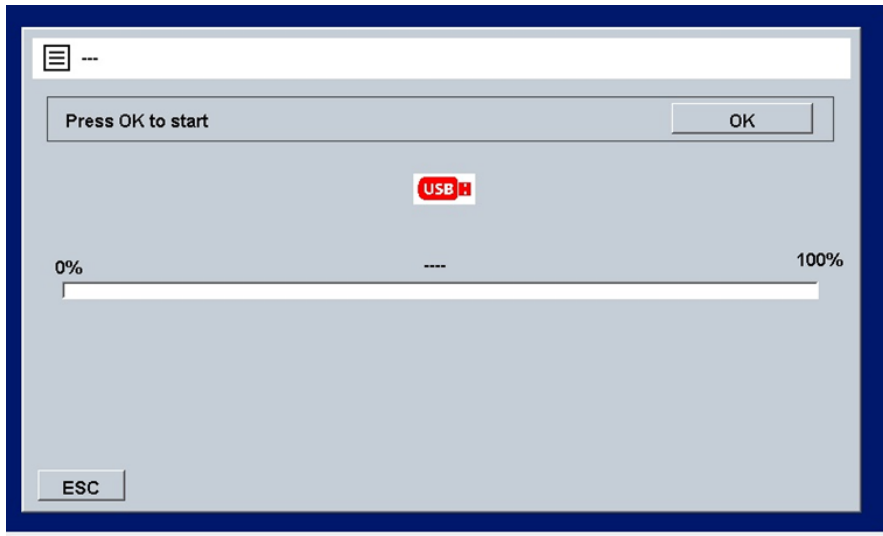
Permite modificar la ID de esclavo, introduciendo una nueva (ID = 1 por defecto)

8.5 NÚMERO DE SERIE

Permite modificar el número de serie del instrumento

8.6 RESETEAR USUARIO PREDETERMINADO

Permite resetear todos los parámetros y restablecer las configuraciones de fábrica.

8.7 CONEXIÓN A FLUIDRA CONNECT

Conexión al armario de control Connect & Go

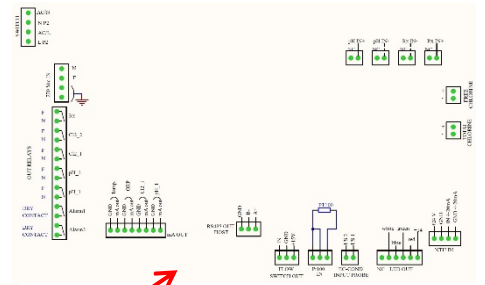
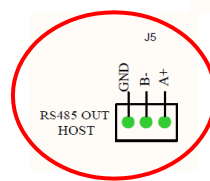
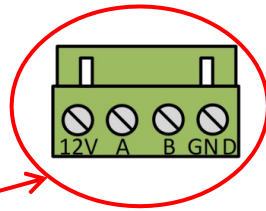

Conexionado:

Connect & Go	12V	A	B	GND
Guardian Pool	No usado	A+	B-	GND

Conexión a la Connect Box

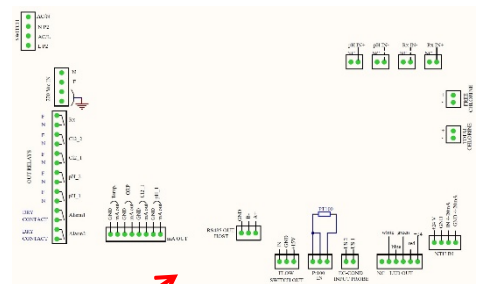
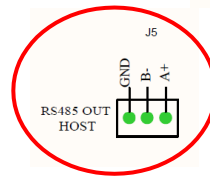
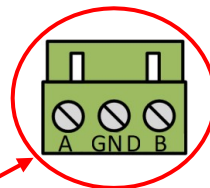
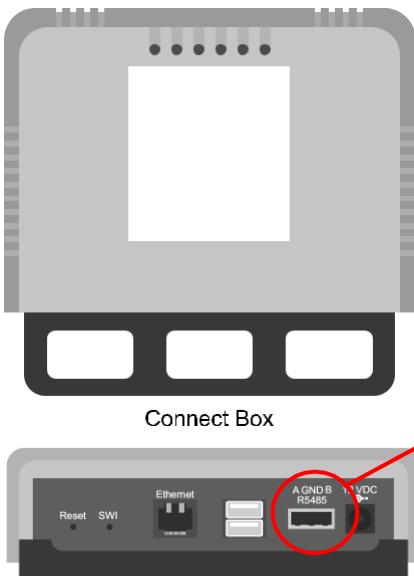

Conexionado:

Connect Box	A	B	GND
Guardian Pool	A+	B-	GND

CONTRÔLEUR MULTIPARAMÉTRIQUE FLUIDRA

SYSTÈMES GUARDIAN Pool_NN

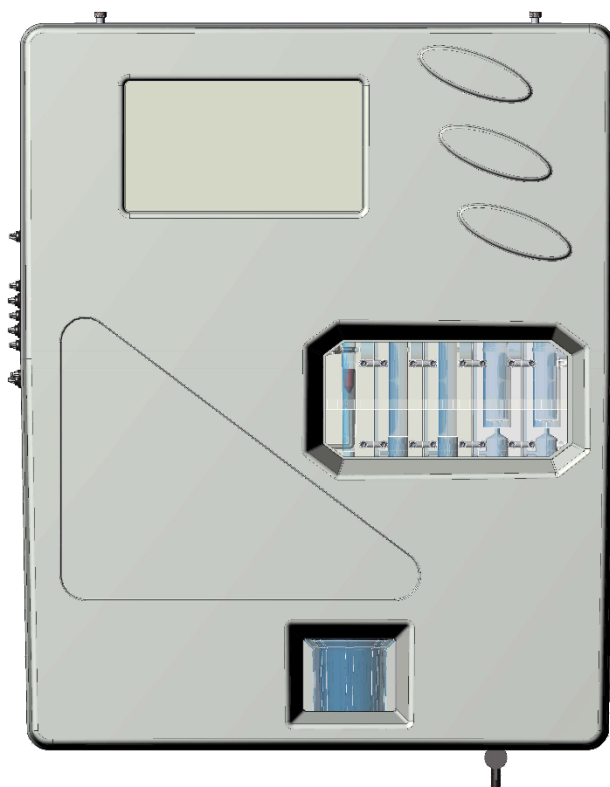

MANUEL D'UTILISATION

INDEX

1	GÉNÉRALITÉS	4
1.1	LIMITES D'UTILISATION ET PRÉCAUTIONS POUR LA SÉCURITÉ	4
1.1.1	SÉCURITÉ ÉLECTRIQUE	4
1.2	SYMBOLE ATTENTION.....	4
1.2.1	ATTENTION PARTICULIÈRE À ACCORDER À CERTAINS COMPOSANTS CRITIQUES.....	5
1.2.2	SÉCURITÉ DE L'ENVIRONNEMENT D'UTILISATION.....	5
1.3	CARACTÉRISTIQUES TECHNIQUES PRINCIPALES	6
1.3.1	CARACTÉRISTIQUES TECHNIQUES	7
2	DESCRIPTION GÉNÉRALE	8
3	PROGRAMMATION	9
3.1	ÉCRAN PRINCIPAL.....	9
3.1.1	PARAMÈTRES GÉNÉRAUX.....	9
3.1.2	RÉGLAGES D'USINE	11
3.1.3	DÉBIT.....	11
3.1.4	WI-FI.....	12
3.1.5	DATE ET HEURE	12
3.2	MESURES.....	13
3.2.1	SET POINT [Point de consigne]	14
3.2.2	CALIBRATION [Étalonnage].....	17
3.2.3	GRAPHICS [Graphiques]	18
3.2.4	ALARM VALUES [Valeurs alarme]	18
3.2.5	MEASURE NAME [Nom mesure]	18
3.2.6	FIRST CALIBRATION [Premier étalonnage].....	18
3.2.7	PLAGE.....	18
4	INSTALLATION	19
4.1	KIT D'INSTALLATION	19
4.2	MONTAGE MURAL.....	20
4.3	BORNIER DE CONNEXION	21
4.4	BRANCHEMENTS ÉLECTRIQUES.....	24
4.5	BRANCHEMENTS HYDRAULIQUES.....	25
4.6	CONNEXION DES SONDES.....	26
4.6.1	CONNEXION DE LA SONDE PH ET REDOX	26
4.6.2	CONNEXION DE LA SONDE DE CONDUCTIVITÉ.....	26
4.6.3	CONNEXION DE LA SONDE DE CHLORE.....	26
4.6.4	CONNEXION DE LA SONDE DE TEMPÉRATURE.....	26
5	MISE EN MARCHÉ ET FONCTIONNEMENT	27
5.1	MISE EN MARCHÉ	27
5.2	FONCTIONNEMENT	27
5.3	RÉGLAGE DU DÉBIT	28
6	ENTRETIEN	29
6.1	NETTOYAGE GÉNÉRAL DU SYSTÈME.....	29
6.2	NETTOYAGE/REPLACEMENT DU FILTRE À EAU	29
6.3	NETTOYAGE DE LA SONDE/ÉLECTRODE	30
6.4	INSPECTION DU CIRCUIT HYDRAULIQUE	30
7	DÉPANNAGE	31
8	APPENDIX [ANNEXES]	32
8.1	Version PLUS.....	32

8.2	FIRMWARE [MICROLOGICIEL]	33
8.3	MENU « ADVANCED » [avancé]	33
8.4	MODBUS SLAVE ID	33
8.5	SERIAL NUMBER [numéro de série].....	33
8.6	RESET DEFAULT USER [REINITIALISATION UTILISATEUR PAR DEFAUT].....	33
8.7	CONNEXION À FLUIDRA CONNECT	34

1 GÉNÉRALITÉS

1.1 LIMITES D'UTILISATION ET PRÉCAUTIONS POUR LA SÉCURITÉ

Afin d'assurer la sécurité de l'opérateur ainsi que le bon fonctionnement de l'équipement, il est important de travailler dans les limites autorisées et d'adopter toutes les précautions énumérées ci-dessous :

ATTENTION



Avant l'utilisation, vérifier que toutes les exigences de sécurité sont parfaitement respectées. Ne pas allumer ni connecter l'équipement à un autre équipement tant que les conditions de sécurité ne sont pas satisfaites.

1.1.1 SÉCURITÉ ÉLECTRIQUE

ATTENTION



Toutes les connexions doivent être isolées de la terre de l'environnement (la masse n'est pas isolée).

Ne raccorder AUCUNE de ces connexions à la terre.

Afin de garantir des conditions de sécurité maximale pour l'opérateur, nous recommandons de suivre toutes les indications fournies dans ce manuel.

- **Alimenter l'équipement en utilisant exclusivement la tension du réseau, conformément aux spécifications (100 ÷ 240 Vca/cc 50-60 Hz)**
- **Remplacer immédiatement tout composant endommagé. Remplacer immédiatement tout câble, connecteur, accessoire ou autre composant de l'équipement qui est abimé ou qui ne fonctionne pas correctement. Le cas échéant, contacter le centre d'assistance technique agréé le plus proche.**
- **Conformément à la norme UL, ne pas connecter à des sorties de relai dont la tension dépasse 115 V**

1.2 SYMBOLE ATTENTION

Le symbole **ATTENTION** représenté ci-dessous rappelle à l'opérateur qu'il doit lire le manuel d'utilisation pour disposer d'informations, conseils et suggestions importants pour l'utilisation correcte et sûre de l'équipement.

Ce symbole est aussi utilisé dans le logiciel, en particulier à l'écran « mesures » [mesures], pour porter l'attention sur un événement qui est expliqué dans les pages-écrans successives.



En particulier, lorsqu'il est situé près de points de raccordement à des câbles et périphériques, ce symbole indique qu'il est nécessaire de lire attentivement le manuel d'utilisation pour disposer des instructions liées à la nature de ces câbles et périphériques et aux méthodes à suivre pour des raccordements corrects et sûrs.

Ce chapitre comporte les reproductions des panneaux de l'équipement, avec les commandes, connexions, symboles et étiquettes correspondants. Chaque symbole d'attention est accompagné d'une explication détaillée de sa signification.

1.2.1 ATTENTION PARTICULIÈRE À ACCORDER À CERTAINS COMPOSANTS CRITIQUES

L'instrument est doté d'un écran à cristaux liquides LCD qui contient de petites quantités de substances toxiques.

1.2.2 SÉCURITÉ DE L'ENVIRONNEMENT D'UTILISATION

Le panneau est protégé contre l'introduction de liquides. Ne pas soumettre l'équipement à des risques d'écoulement d'eau, de pulvérisations d'eau ou d'immersions dans l'eau, et éviter de l'utiliser dans des environnements qui présentent ces risques. Les équipements dans lesquels des liquides ont accidentellement pénétré doivent être immédiatement éteints, nettoyés et contrôlés par un personnel qualifié et autorisé.

Après la programmation, nous recommandons de fermer le panneau transparent.

Protection :

- avec un panneau transparent fermé IP65 EN60529
- avec un panneau transparent ouvert IP54
- EMI/RFI CEI EN55011 - 05/99
- Utiliser l'équipement dans les limites environnementales de température, d'humidité et de pression indiquées.

Cet instrument a été développé pour fonctionner dans les conditions environnementales suivantes :

- Température de l'environnement de fonctionnement : $-0\text{ °C} \div +50\text{ °C}$
- Température de stockage et de transport : $-10\text{ °C} \div +50\text{ °C}$
- Humidité relative : $10\% \div 95\%$ humidité relative – sans condensation

ATTENTION



L'installation de traitement de l'eau dans laquelle l'instrument est introduit doit être développée conformément aux exigences fonctionnelles imposées par la loi en vigueur.

L'appareil doit être parfaitement inséré dans l'installation.

L'installation doit être maintenue en état de fonctionner en parfaite conformité avec les dispositions réglementaires en matière de sécurité.

Les paramètres indiqués sur le boîtier du dispositif de commande de l'analyseur doivent être conformes aux réglementations en vigueur.

Tout instrument de signalisation d'erreur au dispositif doit être positionné dans un environnement constamment sous contrôle des opérateurs ou des assistants de l'installation.

Toute non conformité à une des conditions peut faire fonctionner la « logique » de l'appareil d'une manière potentiellement dangereuse pour les utilisateurs du service.

Par conséquent, nous recommandons que le personnel de service et/ou maintenance agisse avec une prudence maximale, et qu'il informe immédiatement de tout changement dans les paramètres de sécurité, afin d'éviter que des situations potentiellement dangereuses ne surviennent.

Étant donné que les considérations susmentionnées ne peuvent pas être contrôlées par le produit en question, le fabricant se dégage de toute responsabilité en cas de dommages causés par ces dysfonctionnements à des personnes ou des biens.

1.3 CARACTÉRISTIQUES TECHNIQUES PRINCIPALES

- Mesure simultanée de : Chlore libre, pH, Redox et Température
(En option : Chlore total, Chlore combiné)
- **Programmation** : à travers le menu de l'écran tactile
- LCD STN 240x128 rétroéclairé
- Enregistreur de données interne Flash avec 4 Mbit de stockage, soit un équivalent de 16 000 enregistrements, avec possibilité de voir l'évolution des mesures à travers des tableaux et des schémas, où sont indiquées les valeurs minimum, maximum et moyenne de la période.
 - **Intervalle d'enregistrement** : 00:00 ÷ 99:99 min
 - **Type** : circulaire / remplissage
 - **Affichage** : tableau/schéma
- **P.I.D. Réglage pour la sortie de pH**
- **Sortie série RS485** : Protocole MODBUS RTU avec vitesse programmable 1200 ÷ 38400 de débit en Bauds. Pour la configuration, condition Real Time ou téléchargement de données
- 4 sorties analogiques :
 - **Quantité** : ppm Cl₂, pH, Redox, Température.
 - **Typologie** : 0,00 / 4,00 ÷ 20,00 mA isolées galvaniquement
 - **Programmation de la limite** : inférieure/supérieure/Inversion
 - **Charge max** : 500 Ohm
- sortie d'alarme selon NAMUR 2,4 mA (avec plage 4/20 mA)
- 2 sorties de relai d'alarme (absence d'eau échantillon, réactifs épuisés, projecteur grillé, cellule sale)
- 2 sorties de relai du point de consigne 2 pour la mesure du chlore
- 2 sorties de relai du point de consigne 2 pour la mesure du pH
- 1 sortie de relai du point de consigne 2 pour la mesure de Redox
- 1 sortie de relai du point de consigne 2 pour la mesure de la température (mais aussi, sur demande, du chlore total et du chlore combiné).

Caractéristiques matérielles principales du dispositif

- La structure matérielle de ce périphérique repose sur l'adoption d'un nouveau processeur CMOS avec 16 bits, spécifiquement développé pour l'exécution des applications dites « intégrées ».
- La carte utilise un EEPROM pour enregistrer les données de configuration, et des mémoires flash pour l'enregistrement des archives des données historiques et des fichiers LOG des événements.
- La carte a un bus RS485 (opto-isolé) pour les réseaux locaux utilisés en vue des connexions avec les dispositifs de communication locaux (ordinateur de configuration, bornes et télécommandes, etc.).
- La carte comprend une horloge temps réel (horloge avec date) qui permet au logiciel d'enregistrer les données par ordre chronologique.

1.3.1 CARACTÉRISTIQUES TECHNIQUES

Contrôleur multiparamétrique pour la détermination de :
Chlore libre, Chlore total, pH, Redox, Température et Turbidité

Paramètre	Plage	Résolution	Précision
Chlore libre	00,00 ÷ 02,00 ppm ou 10,00 ppm Cl ₂	0,01 ppm	1 % pleine échelle
Chlore total	00,00 ÷ 10,00 ppm Cl ₂	0,01 ppm	1 % pleine échelle
pH	00,00 ÷ 14,00 pH	0,01 pH	1 % pleine échelle
Redox	±1 000 mV	1 mV	1 % pleine échelle
Température	00,0 ÷ 65,0 °C	0,1 °C	1 % pleine échelle
Écran graphique	Écran tactile résistif rétroéclairé TFT 7". Affichage simultané des valeurs de mesure, de la condition des sorties numériques, de la condition de la mémoire, des dysfonctionnements. Programmation tactile		
Enregistreur de données interne	Flash 32 Mbit Intervalle d'enregistrement : 00:00 ÷ 99:99 min Type : circulaire / remplissage Affichage : tableau/schéma		
4 sorties analogiques	ppm Cl ₂ , ppm Cl _{tot} , pH, Température Typologie : 0,00 / 4,00 ÷ 20,00 mA isolées galvaniquement Programmation de la limite : inférieure/supérieure/Inversion Charge max : 500 Ohm Régulation de P.I.D		
5 sorties de relai de point de consigne	2 pour Chlore + 2 pour pH + 1 pour Redox Point de consigne avec hystérésis : 00,00 ÷ 05,00 ppm Cl ₂ / 00,00 ÷ 14,00 pH / ± 1 500 mV Programmation de l'hystérésis Charge résistive max du relai 6 A à 250 Vca		
2 sorties de relai d'alarme	Cumulative ON-OFF pour : Min/Max, point de consigne Charge résistive max des relais 6 A à 250 Vca		
Entrée numérique	Pour capteur de débit		
Sortie série RS485	Protocole MODBUS RTU avec vitesse programmable 1200 ÷ 38400 de débit en Bauds, pour la configuration, condition Real Time ou téléchargement de données		
Conditions de fonctionnement	Température de fonctionnement : 0÷50 °C Stockage et transport : -25÷65 °C Humidité 10-95 % sans condensation		
Alimentation électrique/ Protection électrique	Alimentation : 90÷260Vca/cc 50-60 Hz Absorption moyenne : 30 W Protection électrique :		
Boîtier	Boîtier plaque unique ABS		

2 DESCRIPTION GÉNÉRALE

Le panneau Guardian **Pool_NN** comprend les modèles suivants :

N.	Modèle	Code	Description
1	Guardian Pool_NN 1 Chlore libre 10 ppm	72700	- Avec capteur pour chlore organique (2) 0-10 ppm - Température
2	Guardian Pool_NN 2 Eau potable Chlore libre 2 ppm	72701	- Avec capteur pour chlore organique (2) 0-2 ppm - Température
3	Guardian Pool_NN 3 pH et chlore libre	72702	- pH - Chlore libre organique (2) 0-10 ppm. - Température
4	Guardian Pool_NN 4 pH – ORP	72703	- pH - Capteur ORP, dans électrode en or (Sensorex) - Température
5	Guardian Pool_NN 5 pH – ORP – chlore libre	72704	- pH - Capteur ORP, dans électrode en or (Sensorex) - Chlore libre organique (2) - Température
6	Guardian Pool_NN 6 pH, ORP, chlore libre, chlore total, chlore combiné. Entrée pour NTU (4- 20 mA)	72705	- pH - Capteur ORP, dans électrode en or (Sensorex), - Chlore libre - Chlore total - Capteur de turbidité - Température
7	Guardian Pool_NN 7 pH, chlore libre, Entrée pour NTU (4- 20 mA)	74720	- pH - Chlore libre - Capteur de turbidité - Température

REMARQUES :

(1) Dans la version ppm, avec la conversion au **Bromure** (facteur de conversion 2,4) dans l'équipement réel, le client peut choisir de lire le chlore ou le bromure.

(2) Ce capteur peut lire le **NaClO** (hypochlorite de sodium), le **Ca(ClO)₂** (hypochlorite de calcium), le **Cl₂** (chlore gazeux), le chlore généré électrolytiquement et le chlore combiné organique à partir de l'acide isocyanurique (testé à une concentration d'acide isocyanurique jusqu'à 500 mg/l).

3 PROGRAMMATION

Ce manuel contient toutes les informations servant à l'utilisation de l'écran de l'instrument. Toutes les fenêtres opérationnelles seront analysées, avec des photos et des explications.

3.1 ÉCRAN PRINCIPAL

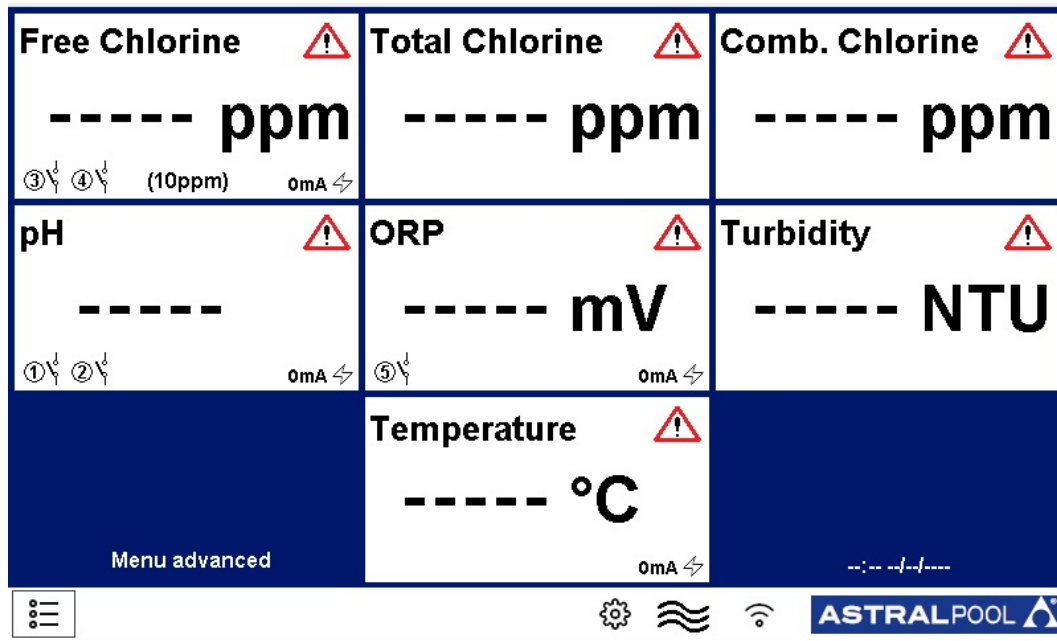

Figure 1 Écran principal

3.1.1 PARAMÈTRES GÉNÉRAUX

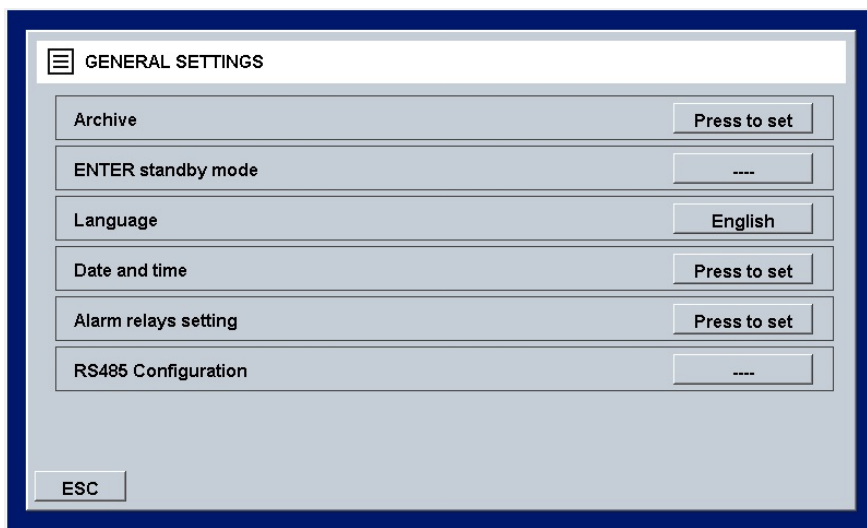

Figure 2 Paramètres généraux

- **Archive** : comment enregistrer les données
 - **STEP [ÉTAPE]** : Choisir à quelle fréquence le système prélève les données (minutes).
 - **TYPE** : Décider le type d'archive de données :
 - **Circle [Cercle]** : Prend les données en mode PEPS.
 - **Finite** : Prend les données jusqu'à atteindre la capacité maximale. Il faut ensuite le vider.
 - **Reset [Réinitialisation]** : Réinitialisation des données enregistrées.
 - **Save on pen drive [Enregistrer sur clé USB]** : Le système enregistre les données sur un port USB.
 - **View record [Voir registre]** : Montre les données archivées.
 - **Alarms Log [Registre des alarmes]** : Montre l'historique des alarmes.

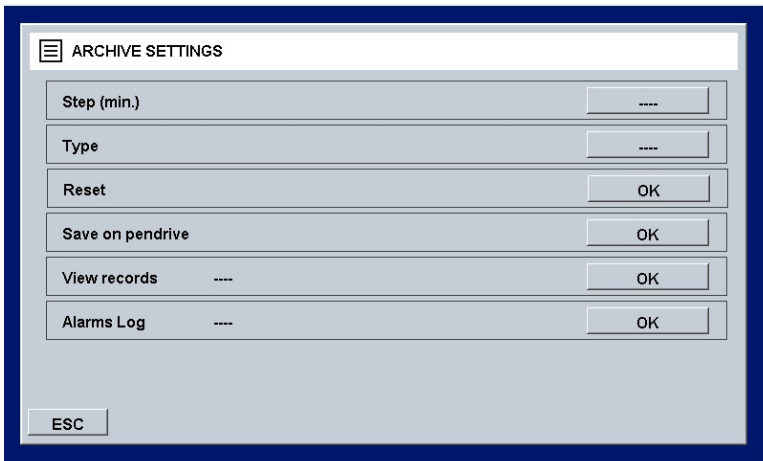

Figure 3 Archive settings [Paramètres des archives]

- **ENTER standby mode [Entrer en mode veille]**
Le système entre en mode veille, il mesure mais il ne fait pas de dosages ni de commandes.
- **Language [Langue]**
Langue définie (Anglais).
- **Date and time [Date et heure] :**
Réglage de la date et l'heure affichée dans la fenêtre principale.

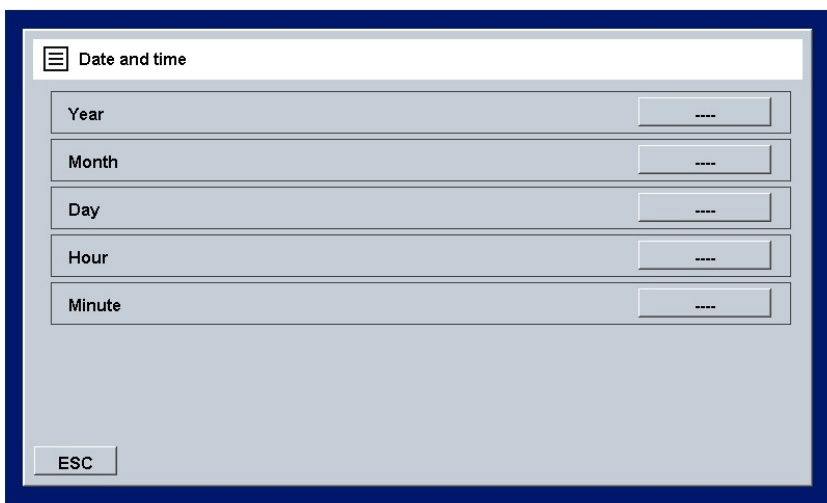

Figure 4 Date and time [Date et heure]

- **Alarm relays setting [Paramètre des relais d'alarme]**

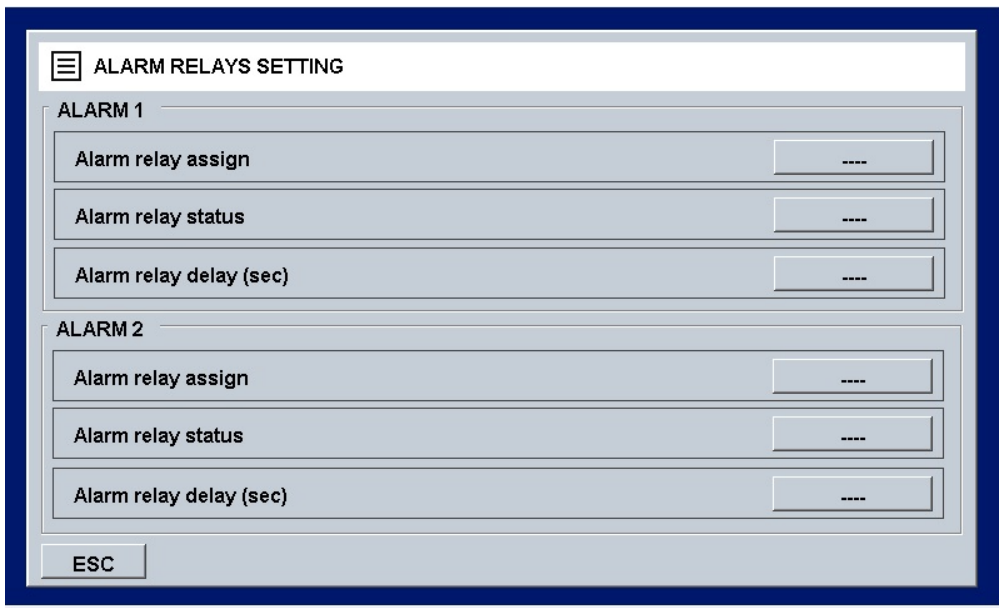

Figure 5 Date and time [Date et heure]

Il y a deux relais d'alarme, et ils sont assignables :

- **ALARM RELAY ASSIGN [Attribution du relai d'alarme]** Choisir la mesure à laquelle affecter le relai; il est possible de choisir entre: toutes les mesures, Combine Chlore Setpoint ou Turbidity Setpoint
- **ÉTAT DU RELAIS D'ALARME** : Il permet de choisir l'état normal du relai :
NO (Normalement ouvert)
NC (Normalement fermé)
- **ALARM RELAY DELAY (SEC) [retard relai alarme (s)]**: Choisir le temps (secondes) au bout duquel le relai change son statut.

3.1.2 RÉGLAGES D'USINE

La fenêtre est protégée par mot de passe. L'explication est à l'annexe.

3.1.3 DÉBIT

Il y a deux états :

 - ON : quand il y a du débit.

 - OFF : quand il n'y a pas de débit.

3.1.4 WI-FI

Cette icône montre s'il y a une connexion Wi-Fi LAN.

Pour se connecter au réseau Wi-Fi LAN, suivre les étapes ci-dessous :

- 1) Se connecter au SSID-XXXX Wi-Fi avec un téléphone ou un ordinateur ; le mot de passe du réseau est : **1234567890**
- 2) Démarrer le navigateur et le connecter à l'adresse : **192.168.4.1** et utiliser les données suivantes pour la connexion :
 - Nom d'utilisateur : **admin**
 - Mot de passe : **0000**
- 3) Après la connexion, s'assurer qu'en haut à gauche du « dashboard » [tableau de bord], la date et l'heure à laquelle la carte a été allumée s'affichent près de **Up since_**

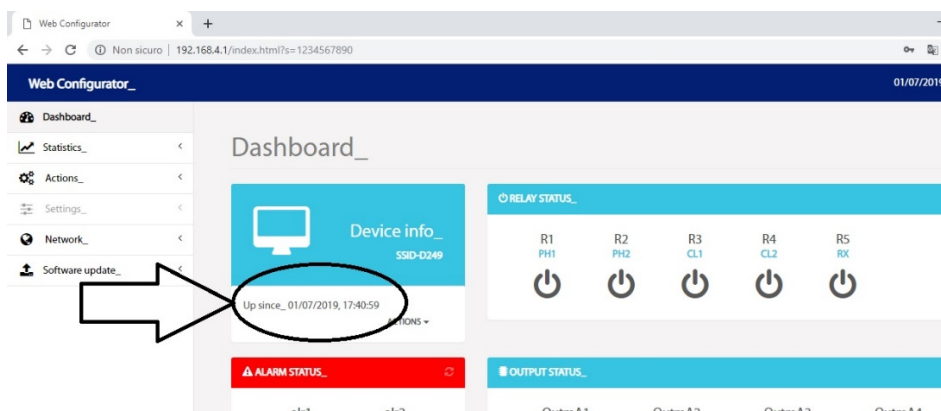

Figure 6 Menu « Setpoint » [point de consigne]

3.1.5 DATE ET HEURE

Ceci montre la date et l'heure réglées dans la fenêtre menu.

3.2 MESURES

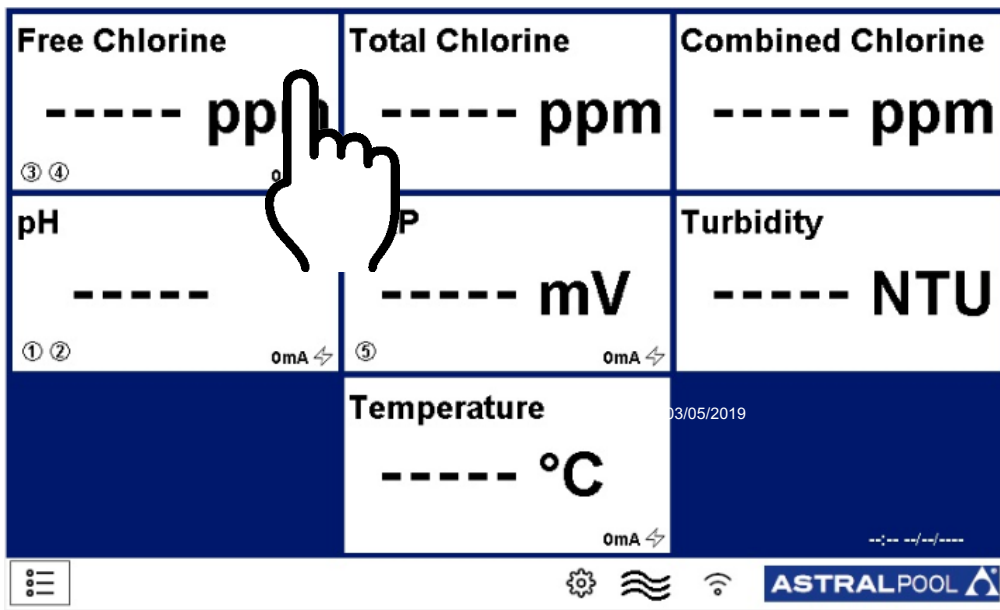

Figure 7 Fenêtre principale

En touchant la case de la mesure dans la fenêtre principale, elle s'ouvre (Figure 7) :

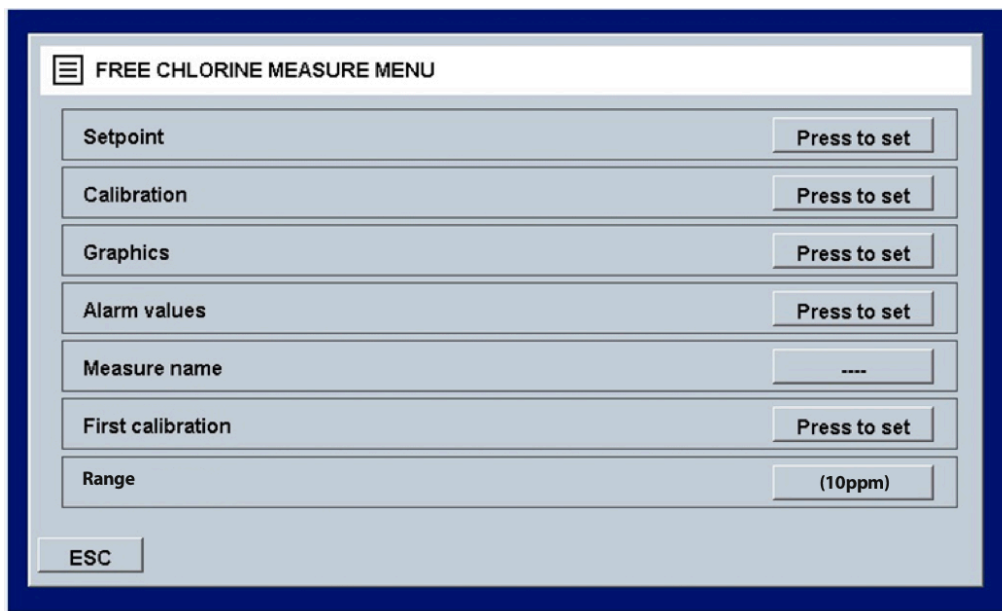
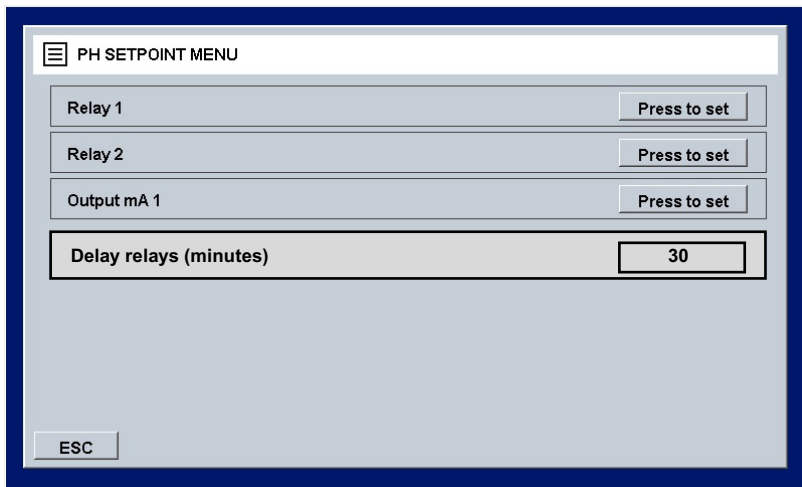

Figure 8 Menu des mesures

Cette fenêtre est la même pour toutes les mesures.

3.2.1 SET POINT [POINT DE CONSIGNE]



Noter:

le menu "retard relais" n'affecte que les relais 3 et 4 du chlore libre, il est activé à la mise sous tension de l'instrument, il a pour fonction d'attendre un temps de polarisation de la sonde chlore libre, un sablier s'affiche sur l'écran principal. 

Figure 9 Menu « Setpoint » [point de consigne]

- **Relays [Relais]**

Le numéro de relai utilisable est différent pour les mesures :

- **Relai n° 1, 2 pH ;**
- **Relai n° 3, 4 Chlore libre ;**
- **Relai n° 5 Rx ;**

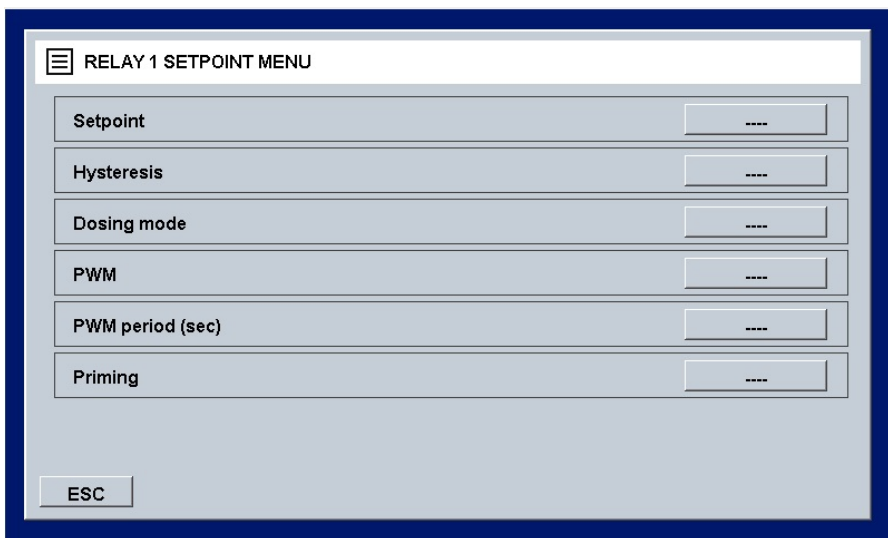

Figure 10 Menu « Relay Setpoint » [point de consigne relai]

Il s'agit des fenêtres réservées au relai :

SETPOINT [point de consigne] : Configurer la valeur du point de consigne en ppm

HYSTERESIS [Hystérésis] : Configurer la plage autour du point de consigne (l'hystérésis du point de consigne est la plage)

DOSING MODE [Mode de dosage] : Configurer le mode du relai :

- HIGH [haut] : Le relai se ferme quand la mesure est inférieur au point de consigne \pm hystérésis, et il s'ouvre quand la mesure est supérieure au point de consigne \pm hystérésis

- LOW [bas] : Le relai s'ouvre quand la mesure est inférieure au point de consigne \pm hystérésis, et il se ferme quand la mesure est supérieure au point de consigne \pm hystérésis

Priming [Amorçage] : Il est possible d'activer les pompes de dosage manuellement en fonction des produits.

Exemples de HIGH/LOW :

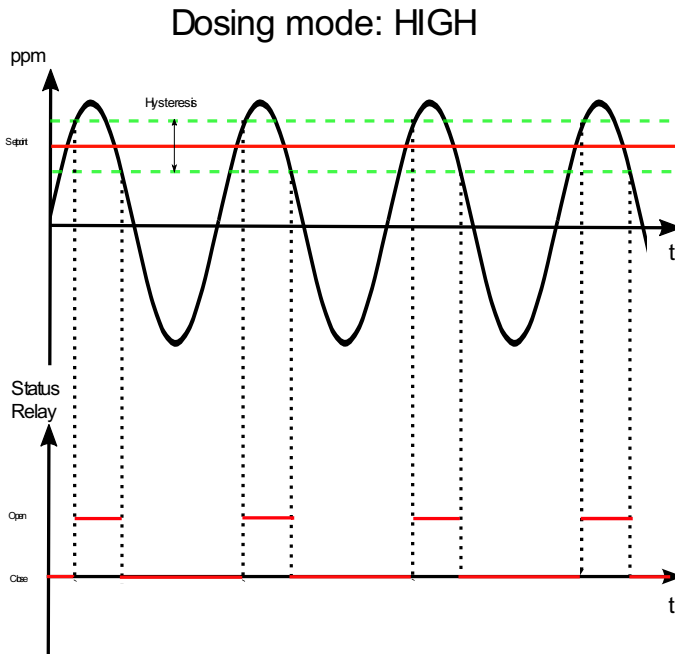

Figure 1 Menu « Relay Setpoint » [point de consigne relai]

C'est choisir d'augmenter la valeur de mesure quand elle chute en dessous d'une valeur définie. Le relai se ferme si la valeur de mesure est inférieure le minimum de la plage, et il s'ouvre quand elle revient au maximum de la plage.

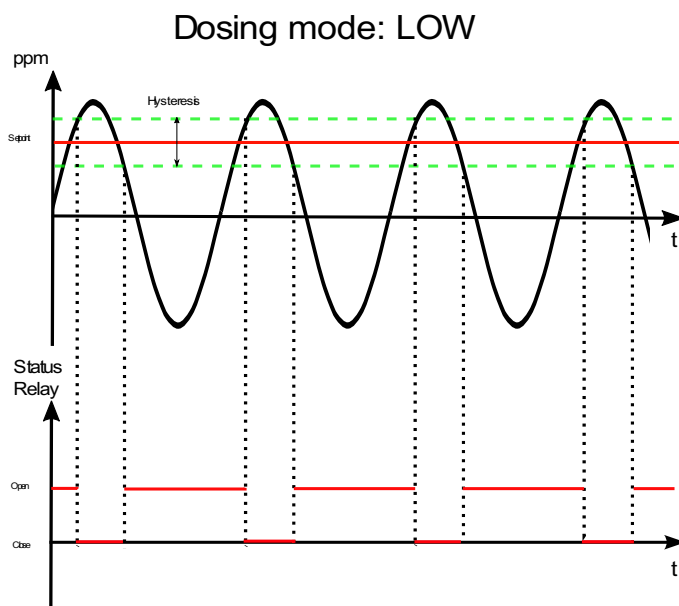

Figure 2 Menu « Setpoint » [point de consigne]

C'est choisir de diminuer la valeur de mesure quand elle augmente au-dessus d'une valeur définie.

Le relais se ferme quand la valeur de mesure est supérieure au maximum de la plage, et il s'ouvre quand elle revient au minimum de la plage.

- **OUTPUT [sortie] mA**

Le nombre de sorties mA utilisables est différent pour les mesures :

- **Sortie mA 1 pH ;**
- **Sortie mA 2 Chlore libre ;**
- **Sortie mA 3 Rx ;**
- **Sortie mA 4 Température ;**

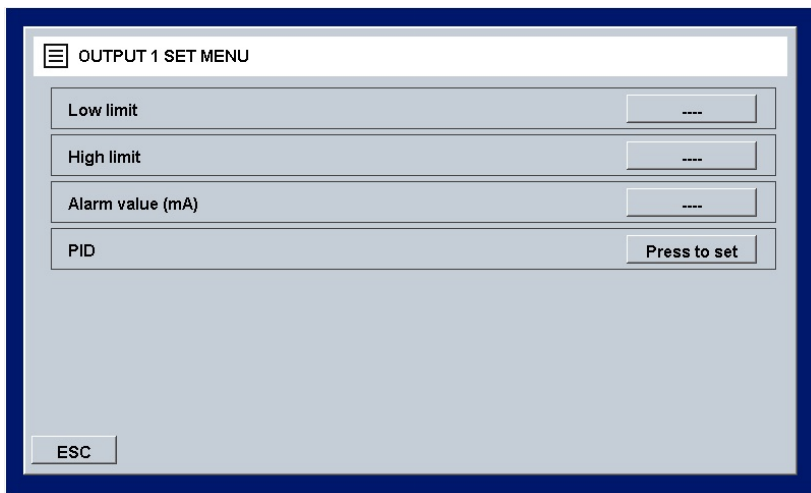

Figure 53 Menu « Output set » [Réglage sortie]

Il s'agit de la fenêtre réservée à la sortie mA :

LOW limit [Limite INFÉRIEURE] : Régler la valeur minimale de sortie.

HIGH limit [Limite SUPÉRIEURE] : Régler la valeur maximale de sortie.

Alarm value (mA) [Valeur alarme (mA)] : Régler la valeur au-delà de laquelle l'alarme se déclenche.

PID : Appuyer pour ouvrir la fenêtre du PID

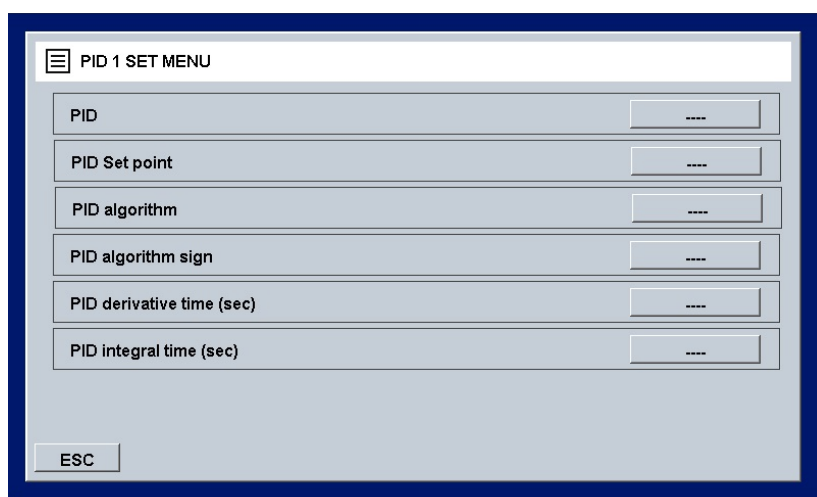

Figure 14 Menu « PID set » [Réglage PID]

PID : PID activé sur la sortie (ON/OFF).

PID Set point [Point de consigne PID] : Définit le point de consigne du PID.

PID algorithm [Algorithme PID] : Définit quel type de PID (P/I/D).

PID algorithm sign [Signe algorithme PID] : Définit le type de contrôle (Direct/Inverse).

- **Valeur Max logique/Valeur Min logique**

Si l'hystérésis n'est pas présente, les limites inférieures et supérieures peuvent être réglées ; si la mesure dépasse ces valeurs, une alarme peut être générée.

3.2.2 CALIBRATION [ÉTALONNAGE]

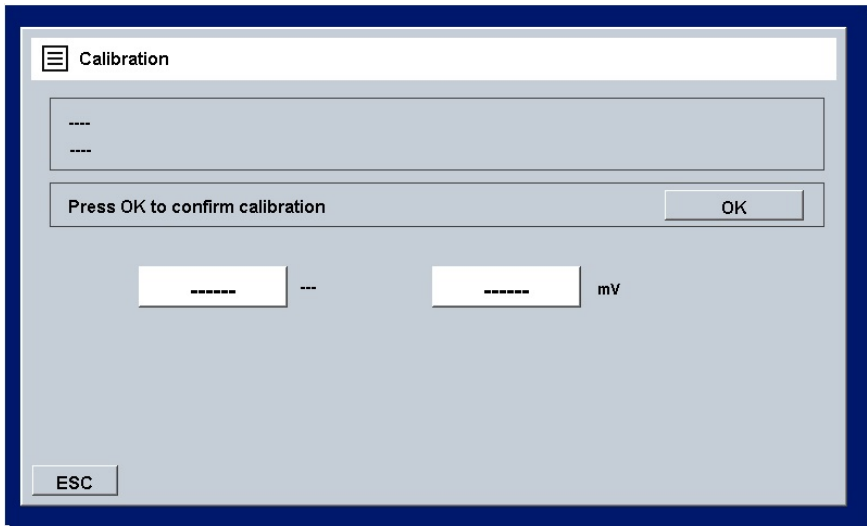

Figure 15 « Calibration » [Étalonnage]

Cet onglet montre la méthode d'étalonnement pour les mesures ; suivre les instructions à l'écran : Insérer la sonde dans le buffer, attendre que la mesure soit stable (dans les zones entourées d'un cercle) puis appuyer sur OK. Ceci ouvre la fenêtre suivante :

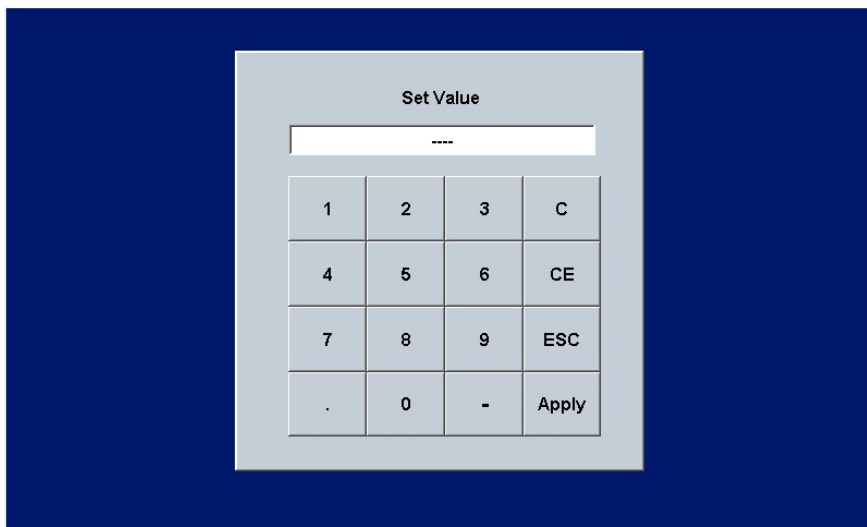

Figure 66 « Set value » [Réglage valeur]

Définir la valeur du tampon et appuyer sur OK.

Seul le pH nécessite un étalonnage à 2 points (avec des solutions buffer 4 pH et 7 pH) : Lorsque vous appuyez sur « Calibrate » [Étalonner], la fenêtre des autres étalonnages s'ouvre.

3.2.3 GRAPHICS [GRAPHIQUES]

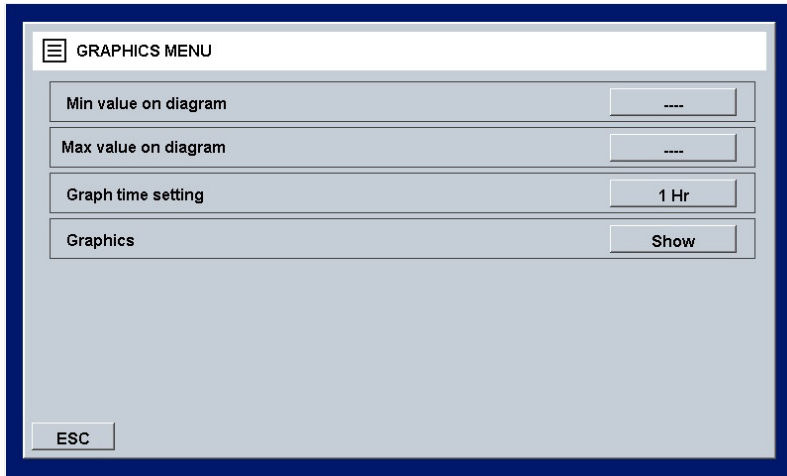

Figure 7 Menu « Graphics » [Graphiques]

- **Min value on diagram [Valeur min. sur schéma]** : Définit la valeur min sur le graphique
- **Max value on diagram [Valeur max sur schéma]** : Définit la valeur max sur le graphique
- **Graph time setting [Réglage temps graphique]** : Définit les axes temps
- **Graphics [Graphiques]** : Appuyer pour visualiser le graphique (figure 18)

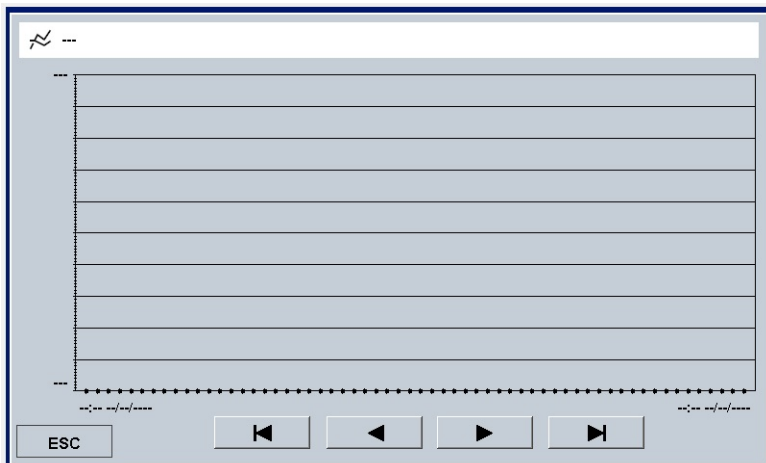

Figure 8 « Graphics » [Graphiques]

3.2.4 ALARM VALUES [VALEURS ALARME]

Définit la valeur max/min au-dessus/en dessous de laquelle l'alarme s'active

3.2.5 MEASURE NAME [NOM MESURE]

Cela permet de modifier le nom de la mesure dans cet onglet

3.2.6 FIRST CALIBRATION [PREMIER ETALONNAGE]

Réalise le premier étalonnage seulement après avoir attendu 90 minutes

3.2.7 PLAGES

Définit la plage de mesure de la sonde.

4 INSTALLATION

Avant d'installer le **contrôleur multiparamétrique AstralPOOL**, lire attentivement ce qui suit. Cette section décrit les étapes pour l'installation de l'équipement et du câblage électrique. Suivre ces indications pendant l'installation.

- S'assurer que l'équipement et tous les appareils associés sont éteints avant de commencer à travailler.
- Si vous observez des anomalies ou des signaux d'avertissement, arrêtez immédiatement. Ne recommencez à travailler qu'après avoir éliminé la cause du problème.
- Ne pas installer l'équipement dans des endroits dangereux ou à risque d'incendie ou d'explosion.
- Éviter les risques électriques. Ne jamais utiliser d'équipement endommagé ou défectueux.

4.1 KIT D'INSTALLATION

	 1 : Vis de fixation (φ=vis 6 mm)	 2 : 8x12 tuyaux PVC Crystal (4 m)	 3 : Porte sonde	 4 : Connecteurs
	 5 : Sonde de chlore libre 2 ppm	 6 : Sonde de chlore libre 10 ppm	 7 : Sonde de chlore total 10 ppm	 8 : Câble pour sonde de chlore(1 m)
	 9 : sonde de pH	 10 : Sonde redox	 11 : Solutions tampon pH	 12 : Solution tampon ORP
 13 : Cartouche de filtre	 14 : Système de contre-lavage	 15 : Porte sonde de turbidité PSS8	 16 : Sonde de turbidité	 17 : Capteur de température
			 18 : Câble et sonde de conductivité	

Numéro	Élément	Pool_NN 1	Pool_NN 2	Pool_NN 3	Pool_NN 4	Pool_NN 5	Pool_NN 6	Pool_NN 7
	Code produit	72700	72701	72702	72703	72704	72705	74720
1	Vis de fixation	•	•	•	•	•	•	•
2	8x12 tuyaux PVC 4 mètres	•	•	•	•	•	•	•
3	Porte sonde	•	•	•	•	•	•	•
4	Connecteurs	•	•	•	•	•	•	•
5	Sonde de chlore libre 2 ppm		•					
6	Sonde de chlore libre 10 ppm	•		•		•	•	•
7	Sonde de chlore total 10 ppm						•	
8	Câble chlore 1 mètre	•(x1)	•(x1)	•(x1)		•(x1)	•(x2)	•(x1)
9	Sonde de pH			•	•	•	•	•
10	Sonde de redox				•	•	•	
11	solution tampon pH7 et pH4			•	•	•	•	•
12	Solution tampon redox 465 mV				•	•	•	
13	Filtre à cartouche 80 µm	•	•	•	•	•	•	•

14	Système de contre-lavage	(*1)	(*1)	(*1)	(*1)	(*1)	(*1)	(*1)
15	Porte sonde de turbidité PSS8						•	
16	Sonde de turbidité						•	
17	Sonde de Température	•	•	•	•	•	•	•
18	Câble et sonde de conductivité	(*1)	(*1)	(*1)	(*1)	(*1)	(*1)	(*1)

(*1 sur demande).

4.2 MONTAGE MURAL

Installer l'unité de commande loin des sources de chaleur, dans un lieu sec, sans éclaboussures d'eau et à l'abri des gouttes d'eau, à une température inférieure à 40 °C. La température minimale ne doit pas descendre en dessous de 0 °C.

S'assurer de laisser assez de place pour les câbles et les connexions pendant l'installation de l'unité de commande.

Le panneau arrière de l'unité de commande est équipé de 4 orifices près des angles, pour monter l'unité au mur. La figure ci-dessous présente la position des orifices à percer ainsi que les dimensions maximales du panneau.

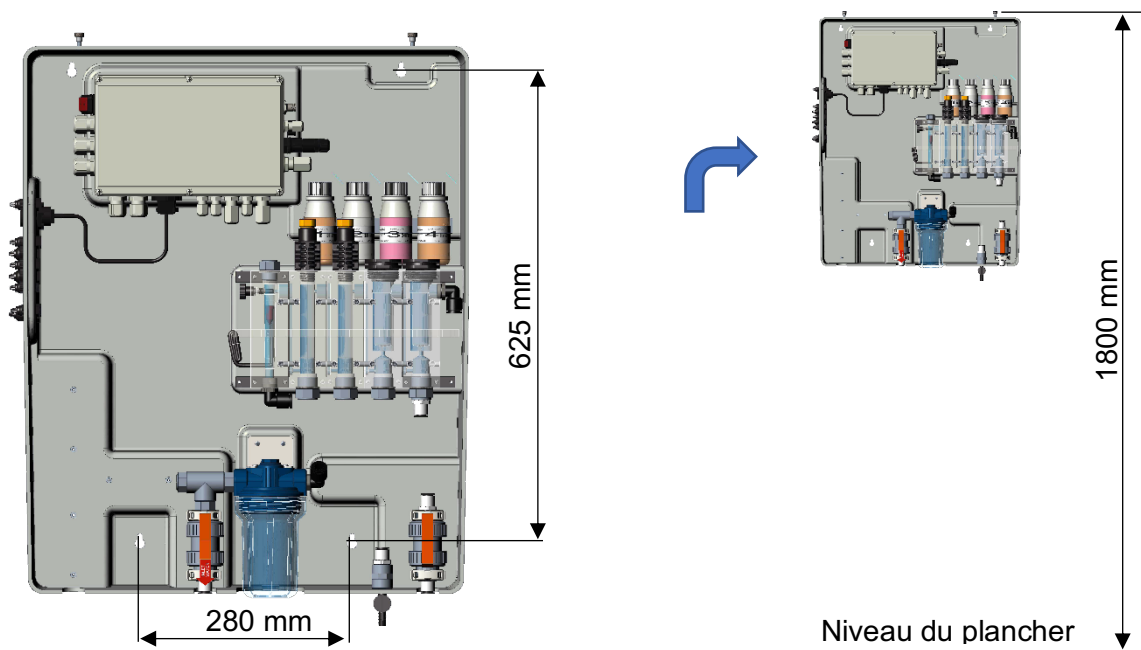

Figure 9 Montage mural du système

Si elles conviennent pour le support, utiliser les prises murales fournies, autrement en choisir d'un type adéquat. L'unité est fournie déjà assemblée et câblée à l'intérieur.

Pour assurer un support optimal pour le système, la paroi doit être aussi droite et lisse que possible.

Percer deux trous alignés horizontalement à une hauteur qui permette à l'opérateur d'avoir une bonne vision du panneau de commande, et à une position qui permette d'effectuer les opérations de commande et d'étalonnage.

La hauteur recommandée à partir du sol est environ 180 cm ou au moins au niveau des yeux.

La distance entre les trous est indiquée sur l'image ci-dessus.

Utiliser un niveau à bulle pendant l'installation, pour mettre l'unité de commande au bon niveau.

La dimension globale du boîtier est : 730x600x230 mm (H x L x P)

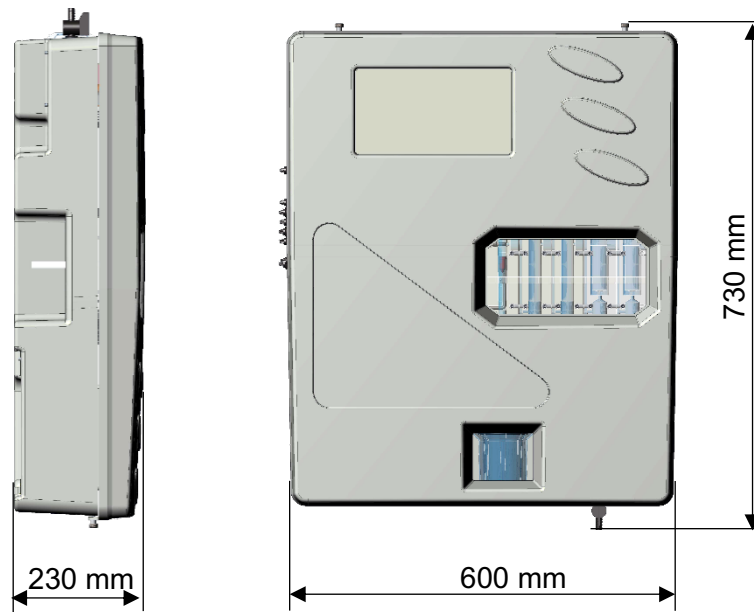

Figure 10 Dimensions du système

4.3 BORNIER DE CONNEXION

Avant d'installer le contrôleur multiparamétrique Astralpool, lire attentivement ce qui suit

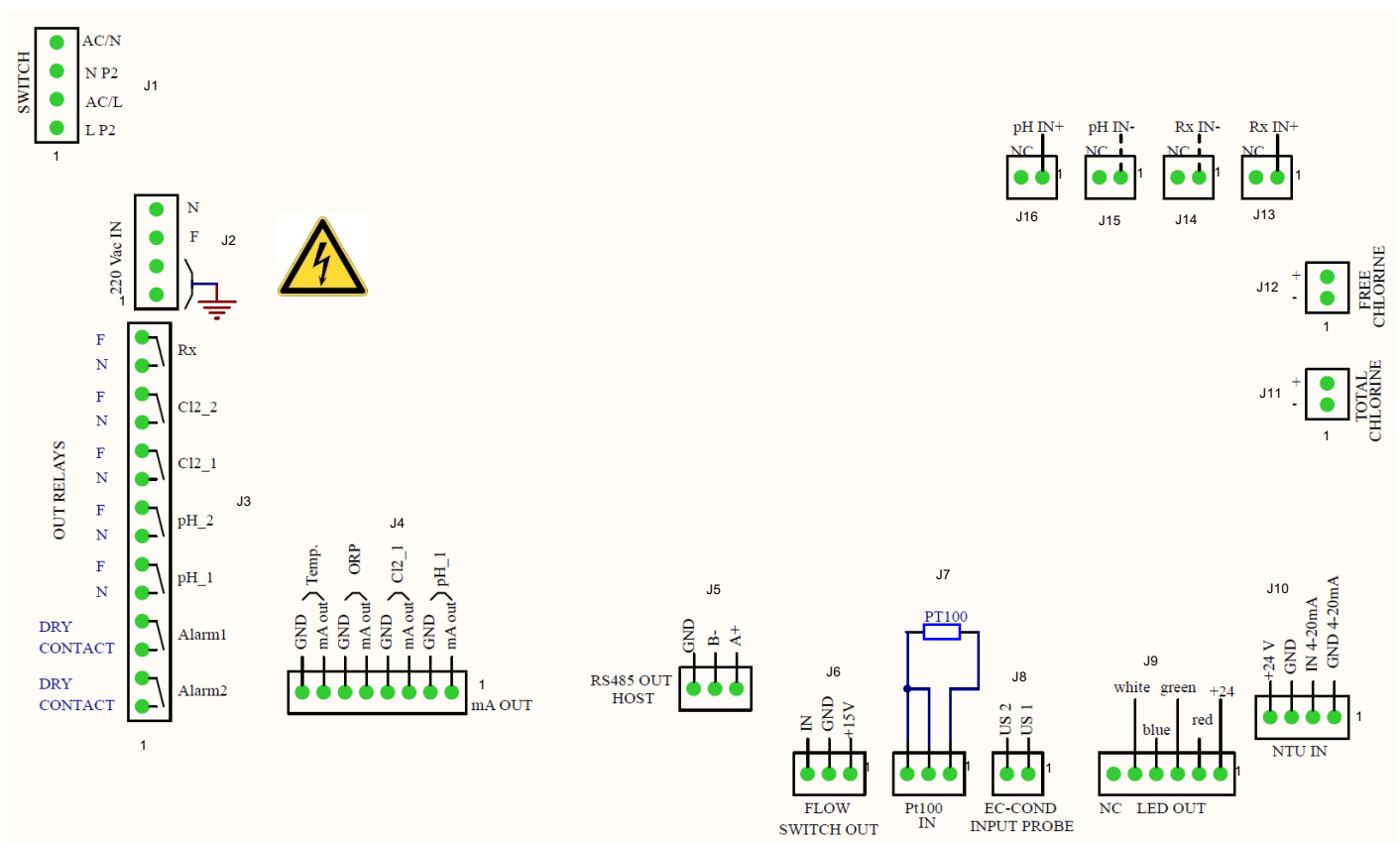
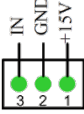

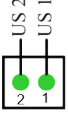
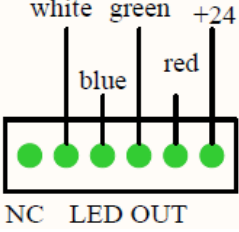
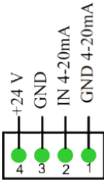







Figure 11 Connexions

Connecteur	Borne	IMAGE	DESCRIPTION	
J1	1		Câble neutre alimentation c.a.	
	2		Câble neutre 220 Vca	
	3		Câble d'alimentation électrique c.a.	
	4		Câble d'alimentation 220 Vca	
J2	1		Câble à terre 1	
	2		Câble à terre 2	
	3		Câble d'alimentation électrique 220 Vca	
	4		Câble neutre alimentation 220 Vca	
J3	1	ALARME 2 	Relai (2) alarme à distance	Contact libre de potentiel
	2		Relai (2) alarme à distance	
	3	ALARME 1 	Relai (1) alarme à distance	Contact libre de potentiel
	4		Relai (1) alarme à distance	
	5	pH_1 	Point de consigne 1 pH	contact alimenté (100-240 Vca)
	6		Point de consigne 1 pH	
	7	pH_2 	Point de consigne 2 pH	contact alimenté (100-240 Vca)
	8		Point de consigne 2 pH	
	9	Cl2_1 	Point de consigne 1 Cl ₂	contact alimenté (100-240 Vca)
	10		Point de consigne 1 Cl ₂	
	11	Cl2_2 	Point de consigne 2 Cl ₂	contact alimenté (100-240 Vca)
	12		Point de consigne 2 Cl ₂	
	13	Rx 	Point de consigne Rx	contact alimenté (100-240 Vca)
	14		Point de consigne Rx	
J4	1	pH_1 	Câble positif pH mA	
	2		Câble négatif pH mA	
	3	Cl2_1 	Câble positif (1) mA Cl ₂	
	4		Câble négatif (1) mA Cl ₂	
	5	ORP 	Câble positif ORP mA	
	6		Câble négatif ORP mA	
	7	Temp 	Câble positif Température mA	
	8		Câble négatif Température mA	
J5	1		Interface RS485 (A+)	
	2		Interface RS485 (B-)	
	3		Interface RS485 (Terre)	

(* 1 Le relais d'alarme peut être réglé sur: Mesure d'alarme tout, point de consigne Comb. CL; point de consigne de turbidité)

Connecteur	Borne	IMAGE	DESCRIPTION		
J6	1		Câble +15 V		
	2		Câble à terre		
	3		Câble IN		
J7	1		Câble de raccordement PT 100		
	2		Câble de raccordement PT 100		
	3		Câble de raccordement PT 100		
J8	1		Sonde EC-Cond	câble 1 μ S	
	2			câble 2 μ S	
J9	1		+24 V		
	2		Rouge		
	3		Vert		
	4		Bleu		
	5		Blanc		
	6		NC		
J10	1		Sonde de turbidité	4-20 mA (Terre)	
	2			4-20 mA (IN)	
	3			Alimentation électrique 24 V-	
	4			Alimentation électrique 24 V+	
J11	1		Sonde de chlore total	Câble négatif Cl_{tot}	
	2			Câble positif Cl_{tot}	
J12	1		Sonde de chlore libre	Câble négatif Cl_2	
	2			Câble positif Cl_2	
J13	1		Sonde ORP	RG 174 Rx (IN +)	
	2				
J14	1				RG 174 Rx (IN -)
	2				
J15	1		Pompe pH	RG 174 pH (IN -)	
	2				
J16	1				RG 174 pH (IN +)
	2				

4.4 BRANCHEMENTS ÉLECTRIQUES

Connexions du bornier :

N	Élément	Fonction	Pool_NN 1	Pool_NN 2	Pool_NN 3	Pool_NN 4	Pool_NN 5	Pool_NN 6	Pool_NN 7
	Code								
1	100-240 Vac 50-60 Hz	Alimentation électrique	72700	72701	72702	72703	72704	72705	74720
2	Relay1 (pH1)	Action dose alimentée	•	•	•	•	•	•	•
3	Relay2 (pH2)	Action dose alimentée			•	•	•	•	•
4	Relay3 (CL1)	Action dose alimentée			•	•	•	•	•
5	Relay4 (CL2)	Action dose alimentée	•	•	•		•	•	•
6	Relai5 (Rx)	Action dose alimentée	•	•	•		•	•	•
7	Relai6 (alr1)	Contact libre de potentiel état d'alarme				•	•	•	
8	Relai7 (Alr2)	Contact libre de potentiel état d'alarme	•	•	•	•	•	•	•
9	mA1 (pH)	Sortie mA	•	•	•	•	•	•	•
10	mA2 (Cl)	Sortie mA			•	•	•	•	•
11	mA3 (Rx)	Sortie mA	•	•	•		•	•	•
12	mA4 (°C)	Sortie mA				•	•	•	
13	Port série RS485	Communication	•	•	•	•	•	•	•
14	Entrée Reed	Entrée état du débit	•	•	•	•	•	•	•
15	Pompe pH	Signal mV d'entrée	•	•	•	•	•	•	•
16	Sonde1 CL	Signal mA d'entrée			•	•	•	•	•
17	Sonde2 CL	Signal mA d'entrée	•	•	•		•	•	•
18	Sonde de turbidité	Signal mA d'entrée						•	
19	Sonde Rx	Signal mV d'entrée						•	•
20	Sonde temp.	Signal Ohm entrée				•	•	•	
21	Sortie Vcc 5	Alimentation électrique des lumières LED	•	•	•	•	•	•	•
22	Connexion Wifi	Connexion Wifi	•	•	•	•	•	•	•
23	Sonde de conductivité	Signal mV d'entrée	•	•	•	•	•	•	•

4.5 BRANCHEMENTS HYDRAULIQUES

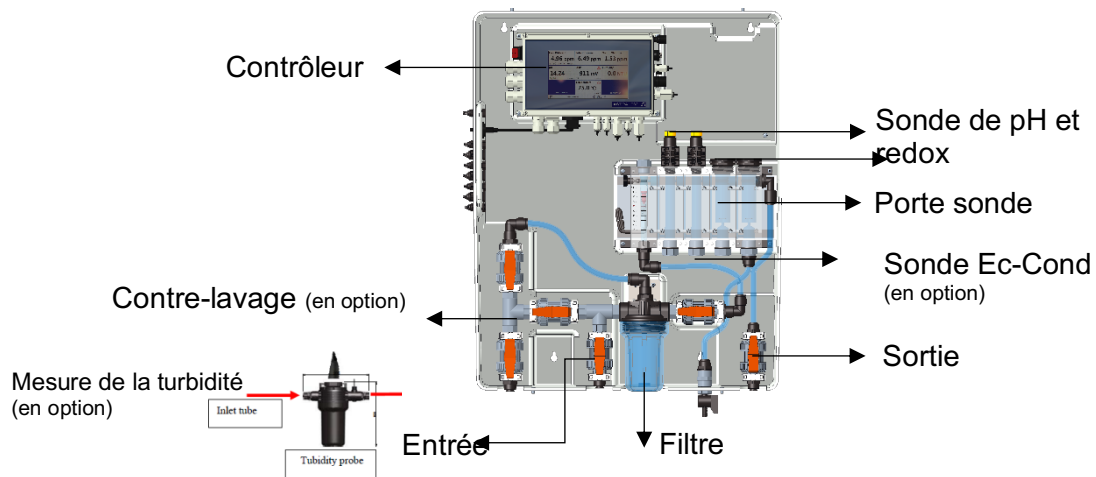

Figure 12 Raccordements hydrauliques

4.6 CONNEXION DES SONDÉS

4.6.1 CONNEXION DE LA SONDE PH ET REDOX

Figure 13 connecteurs pH et Redox



Connecteur sonde
pH

Connecteur sonde
Redox

4.6.2 CONNEXION DE LA SONDE DE CONDUCTIVITÉ

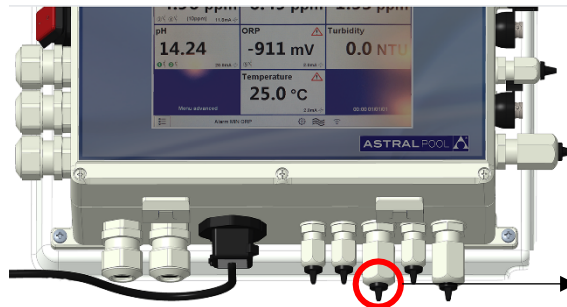

Figure14 Connecteur de conductivité

Connecteur de la sonde de
conductivité (en option)

4.6.3 CONNEXION DE LA SONDE DE CHLORE



Figure 15 Connecteurs chlore

(Remarque : veuillez vérifier les connexions de l'étiquette avec la connexion de polarité des sondes de chlore)

Connecteurs de la sonde de
chlore total et de chlore libre

4.6.4 CONNEXION DE LA SONDE DE TEMPÉRATURE

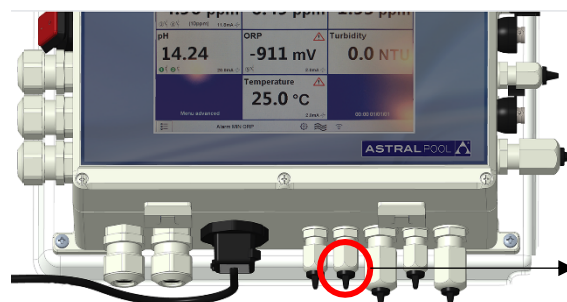

Figure 16 Connecteur température

Connecteur sonde de
température

5 MISE EN MARCHÉ ET FONCTIONNEMENT

5.1 MISE EN MARCHÉ

Allumer le système avec l'interrupteur d'alimentation en haut à gauche du contrôleur.

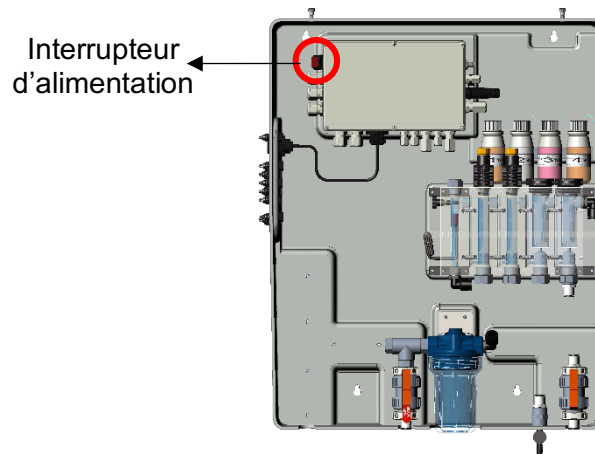
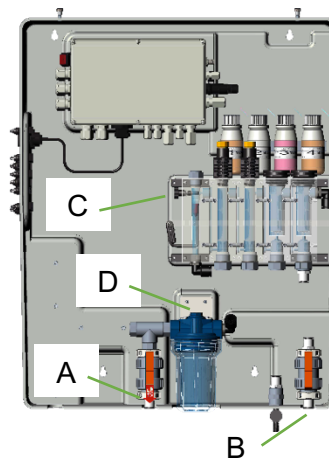

Figure 17 Interrupteur d'alimentation

5.2 FONCTIONNEMENT

- A : Connecter le tuyau d'entrée
- B : Connecter le tuyau de sortie
- C : Ouvrir complètement la régulation du débit
- D : Dégazage de l'air du filtre



5.3 RÉGLAGE DU DÉBIT

Le débit d'eau doit être réglé avec la vanne indiquée dans la figure ci-dessous

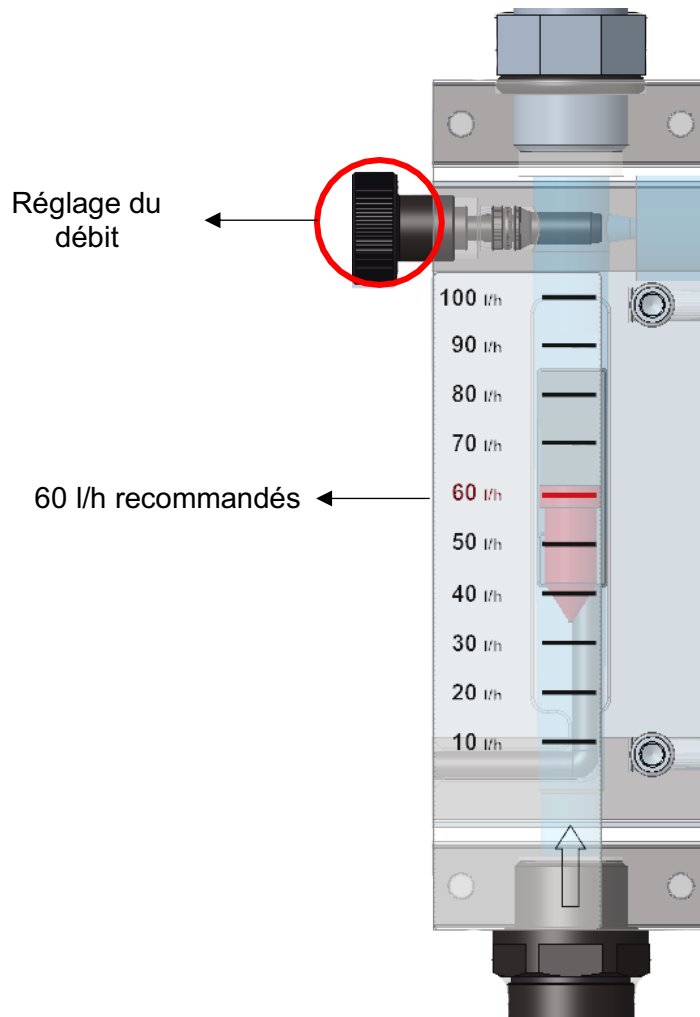

Figure 18 Robinet de débit

6 ENTRETIEN

Effectuer régulièrement l'entretien de l'équipement, afin qu'il maintienne des performances optimales. Nous recommandons aussi de suivre notre programme d'entretien.

Veillez trouver ci-dessous une indication des intervalles maximaux d'entretien :

Opération d'entretien	INTERVALLES DE TEMPS			
	1 mois	2 mois	3 mois	6 mois
Nettoyage général du système				X
Nettoyage du filtre d'eau à maille	X			
Inspection du circuit hydraulique		X		
Nettoyage de la sonde	Selon le manuel d'instructions de la sonde/électrode.			

ATTENTION



Avant de commencer l'entretien, mettre l'équipement hors tension en appuyant sur l'interrupteur principal de la ligne où il est installé.

ATTENTION



Avant d'effectuer toute opération d'entretien, couper le débit d'eau qui arrive à l'équipement depuis le système, et dépressuriser en ouvrant complètement la vanne d'échantillonnage.

6.1 NETTOYAGE GÉNÉRAL DU SYSTÈME

Effectuer cette opération une fois par mois.

Nettoyer régulièrement toutes les surfaces de l'équipement. Utiliser seulement un chiffon humide sans ajouter de solvant ni de produit.

6.2 NETTOYAGE/REPLACEMENT DU FILTRE À EAU

Effectuer cette opération tous les deux mois.

Attendre qu'il n'y ait plus d'eau venant du circuit hydraulique.

Dévisser le bac de l'unité filtre et enlever la cartouche du filtre de l'intérieur ; attention à ne pas perdre les joints.

Placer la cartouche sous l'eau courante et enlever tous les débris du filtre à l'aide d'une brosse souple. Remonter la cartouche du filtre et le bac du filtre sur le système, en étant attentif à remettre les joints bien en place.

Fermer complètement la vanne d'échantillonnage et rétablir le débit d'eau dans le circuit, en ouvrant les vannes graduellement et en relâchant l'air du système. Remettre le système sous tension et vérifier les conditions de fonctionnement après avoir effectué les tests initiaux.

6.3 NETTOYAGE DE LA SONDÉ/ÉLECTRODE

Consulter le manuel d'instructions de la sonde/électrode avant cette opération.

Attendre qu'il n'y ait plus d'eau venant du circuit hydraulique. Déconnecter les câbles de l'électrode en dévissant les connecteurs à leurs extrémités ainsi que les brides de fixation, puis les enlever du porte sonde dans le circuit hydraulique du système. Laver la partie sensible avec de l'eau chaude et du savon doux, en enlevant la graisse résiduelle avec un pinceau à poils doux.

Ne pas laver les sondes en les frottant avec des objets ou chiffons abrasifs qui peuvent les charger électrostatiquement.

En cas de saleté extrême, nettoyer les électrodes en utilisant de l'alcool dénaturé. À la fin du nettoyage, reconnecter les électrodes avec leurs câbles respectifs et les étalonner sans rétablir le débit d'eau du système. Quand la procédure d'étalonnage est terminée, mettre le système hors tension et remplacer les électrodes dans le porte sonde. Reconnecter l'alimentation électrique et le débit d'eau au système après avoir fermé la vanne d'échantillonnage.

6.4 INSPECTION DU CIRCUIT HYDRAULIQUE

Effectuer cette opération tous les six mois.

Inspecter visuellement le circuit hydraulique de l'équipement après l'avoir mis hors tension. En cas de fuite de liquide, de dommages de la tuyauterie ou de problèmes d'étanchéité, agir sur le circuit hydraulique après avoir coupé le débit d'eau arrivant à la station et après avoir dépressurisé le système en ouvrant la vanne d'échantillonnage.

Remplacer les parties endommagées, en recourant uniquement à des pièces de rechange d'origine ou recommandées.

ATTENTION



Ne pas laisser d'impuretés à l'intérieur du circuit hydraulique, car elles pourraient l'obstruer.

ATTENTION



Fermer la vanne d'échantillonnage avant de reconnecter le débit d'eau au système. Rétablir graduellement la pression du système puis remettre l'équipement sous tension.

7 DÉPANNAGE

Défauts mécaniques	
Le débit dans la cellule de mesure est trop faible	Vérifier l'étanchéité des joints toriques Vérifier si le filtre est obstrué Vérifier les vannes d'entrée et de sortie Vérifier la vanne d'échantillonnage
Défauts électriques	
Pas de signal lumineux, écran éteint	Vérifier que l'équipement est correctement alimenté (prise et fiche). Si l'équipement reste inactif, contacter le centre de service
Mesures incorrectes	Vérifier attentivement l'étalonnage, en cas de doutes, réinitialiser les réglages d'usine de l'instrument définis par défaut Vérifier que les sondes fonctionnent correctement et vérifier leur état d'usure

Parfois, du liquide peut fuir d'un raccord mal serré ou d'un écrou à œil, ou simplement à cause de la rupture du tuyau d'alimentation d'eau. Après l'élimination de la fuite, nettoyer et sécher toute eau résiduelle dans le système, car elle pourrait endommager les parties en contact à cause de la stagnation.

8 APPENDIX [annexes]

ATTENTION



Cet ONGLET est protégé par mot de passe. Il est reporté dans ce manuel seulement pour information.

APPENDIX 1 - FACTORY SETTINGS [annexe 1 - réglages d'usine]

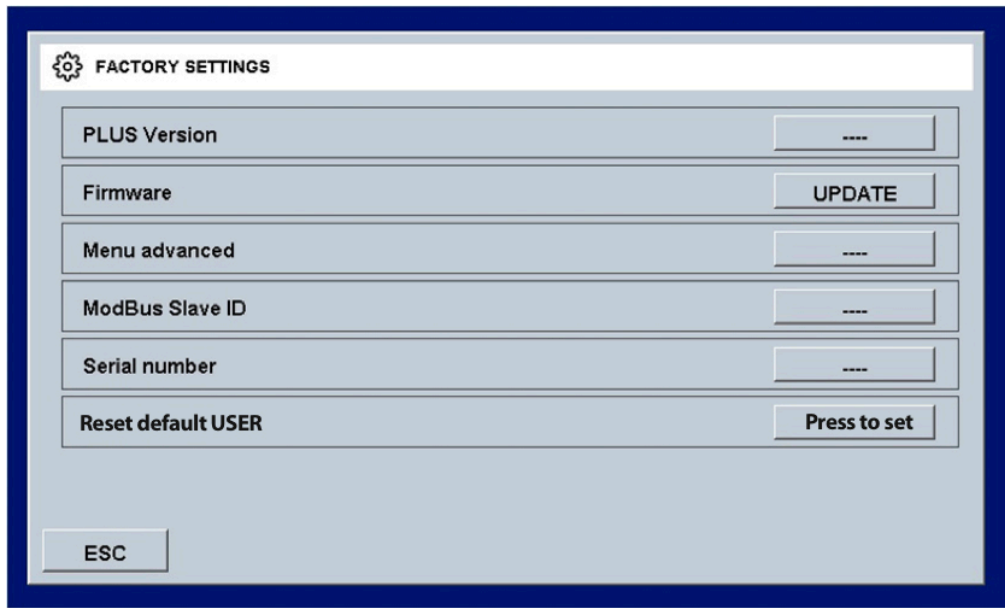

Figure 19 « Factory Settings » [Réglages d'usine]

8.1 VERSION PLUS

Ceci permet de sélectionner le type de version que vous voulez obtenir :

- PLUS 1 (Guardian NN 1) : Chlore libre 10 ppm et Température
- PLUS 2 (Guardian NN 2) : Chlore libre 2 ppm et Température
- PLUS 3 (Guardian NN 3) : Chlore libre 10 ppm, pH et Température
- PLUS 4 (Guardian NN 4) : pH, Redox et Température
- PLUS 5 (Guardian NN 5) : Chlore libre, pH, Redox et Température
- PLUS 6 (Guardian NN 6) : Chlore libre, pH, Redox, Chlore combiné, Turbidité et Température
- PLUS 7 (Guardian NN 7) : Chlore libre, pH, Redox, Turbidité et Température

8.2 FIRMWARE [MICROLOGICIEL]

Ceci permet de mettre à jour le micrologiciel : le fichier du micrologiciel doit être dans une clé USB, qui doit être branchée avant d'appuyer sur OK dans la CASE « Press OK to Start » [Appuyer sur OK pour commencer]

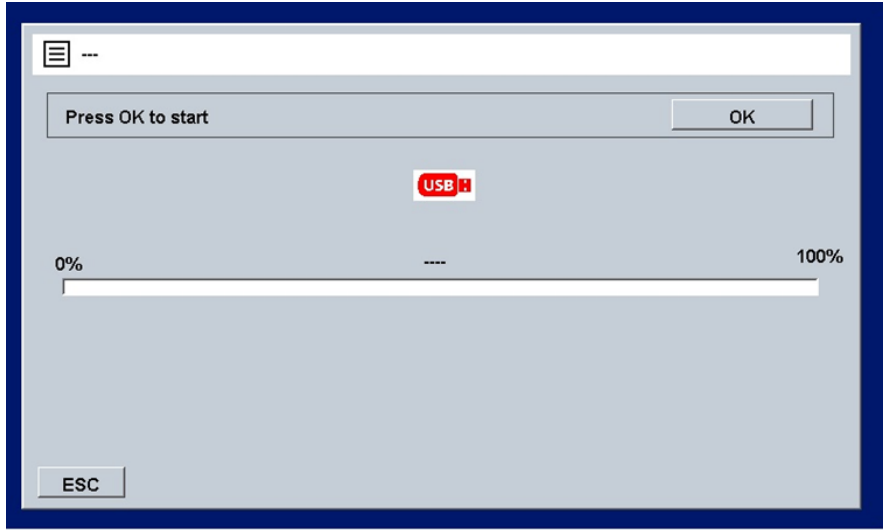

Figure 30 Mise à jour du micrologiciel

8.3 MENU « ADVANCED » [AVANCE]

Il permet de définir le mode avancé, en déverrouillant des menus cachés en mode standard (ON/OFF)

8.4 MODBUS SLAVE ID

Il permet de modifier l'ID Slave, en saisissant un nouveau (ID=1 défaut)

8.5 SERIAL NUMBER [NUMERO DE SERIE]

Il permet de modifier le numéro de série de l'instrument

8.6 RESET DEFAULT USER [REINITIALISATION UTILISATEUR PAR DEFAUT]

Ceci permet de réinitialiser tous les paramètres et de rétablir les réglages d'usine.

8.7 CONNEXION À FLUIDRA CONNECT

Connexion à l'armoire de commande Connect & Go

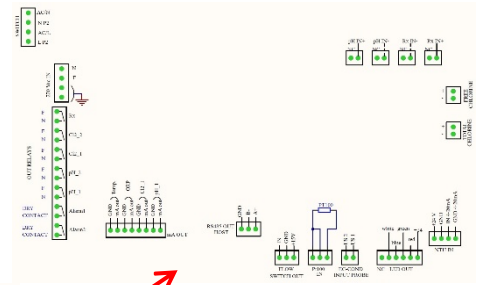
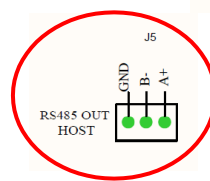
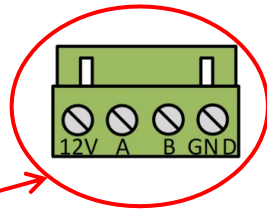

Connexions:

Connect & Go	12V	A	B	GND
Guardian Pool	Non utilisé	A+	B-	GND

Connection to Connect Box

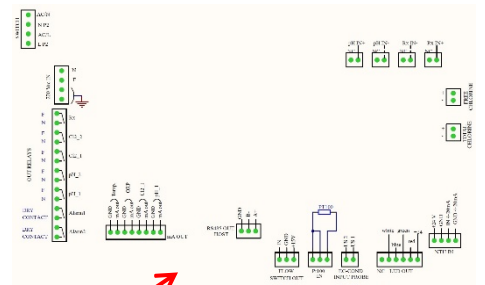
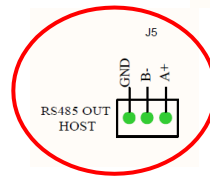
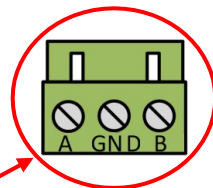
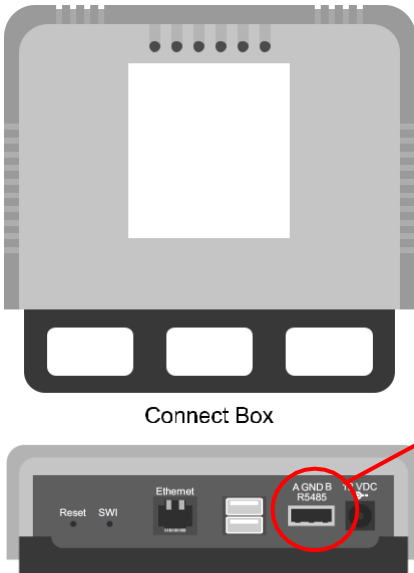

Connexions:

Connect Box	A	B	GND
Guardian Pool	A+	B-	GND

FLUIDRA MULTIPARAMETRICA

SISTEMI GUARDIAN Pool_NN

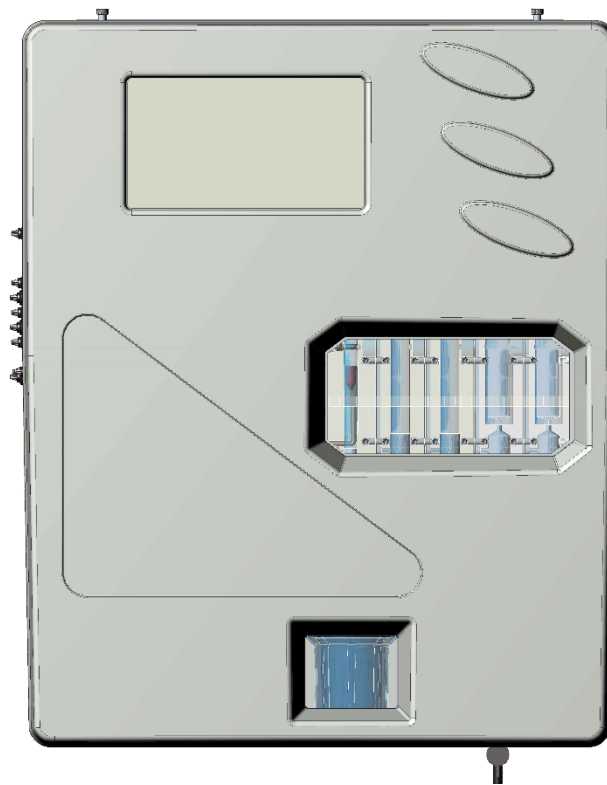

MANUALE D'USO

INDICE

1	GENERALITÀ	4
1.1	LIMITI DI UTILIZZO E PRECAUZIONI PER LA SICUREZZA	4
1.1.1	SICUREZZA ELETTRICA	4
1.2	SIMBOLO DI ATTENZIONE	4
1.2.1	ATTENZIONE SPECIALE AI COMPONENTI CRITICI.....	4
1.2.2	SICUREZZA DELL'AMBIENTE DI ESERCIZIO	5
1.3	CARATTERISTICHE TECNICHE PRINCIPALI	6
1.3.1	CARATTERISTICHE TECNICHE	7
2	DESCRIZIONE GENERALE	8
3	PROGRAMMAZIONE	9
3.1	SCHERMATA PRINCIPALE	9
3.1.1	GENERAL SETTINGS (IMPOSTAZIONI GENERALI).....	9
3.1.2	FACTORY SETTINGS (PARAMETRI DI FABBRICA).....	11
3.1.3	FLOW (FLUSSO).....	11
3.1.4	WI-FI.....	12
3.1.5	DATA AND TIME (DATA E ORA).....	12
3.2	MEASURES (MISURE)	13
3.2.1	SETPOINT.....	14
3.2.2	CALIBRATION (CALIBRAZIONE).....	17
3.2.3	GRAPHICS (GRAFICI).....	18
3.2.4	ALARM VALUES (VALORI ALLARMI).....	18
3.2.5	MEASURE NAME (NOME MISURE).....	18
3.2.6	FIRST CALIBRATION (ULTIMA CALIBRAZIONE).....	18
3.2.7	RANGE (INTERVALLO).....	18
4	INSTALLAZIONE	19
4.1	KIT DI INSTALLAZIONE	19
4.2	MONTAGGIO A PARETE	20
4.3	MORSETTIERA DI COLLEGAMENTO	21
4.4	COLLEGAMENTI ELETTRICI	24
4.5	COLLEGAMENTI IDRAULICI	24
4.6	COLLEGAMENTO SONDE	25
4.6.1	COLLEGAMENTO SONDA PH E REDOX.....	25
4.6.2	COLLEGAMENTO DELLA SONDA DI CONDUCIBILITÀ.....	25
4.6.3	COLLEGAMENTO DELLA SONDA DEL CLORO	25
4.6.4	COLLEGAMENTO SONDA TEMPERATURA.....	26
5	AVVIO E FUNZIONAMENTO	26
5.1	AVVIO	26
5.2	OPERAZIONE	26
5.3	REGOLAZIONE DEL FLUSSO	27
6	MANUTENZIONE	28
6.1	PULIZIA GENERALE DEL SISTEMA	28
6.2	PULIZIA/SOSTITUZIONE DEL FILTRO DELL'ACQUA	28
6.3	PULIZIA SONDA/ELETTRODO	29
6.4	ISPEZIONE DEL CIRCUITO IDRAULICO	29
7	INDIVIDUAZIONE E RISOLUZIONE DEI GUASTI	30
8	APPENDICE	31
8.1	PLUS Version (Versione PLUS)	31

8.2	FIRMWARE.....	32
8.3	MENU ADVANCED (AVANZATO)	32
8.4	MODBUS SLAVE ID (ID SLAVE MODBUS).....	32
8.5	SERIAL NUMBER (NUMERO SERIALE)	32
8.6	RESET DEFAULT USER (REINIZIALIZZA UTENTE PREDEFINITO)	32
8.7	COLLEGAMENTO A FLUIDRA CONNECT	33

1 GENERALITÀ

1.1 LIMITI DI UTILIZZO E PRECAUZIONI PER LA SICUREZZA

Per garantire la sicurezza dell'operatore e il corretto funzionamento dell'apparecchiatura, è importante operare nei limiti consentiti e adottare tutte le precauzioni elencate di seguito:

ATTENZIONE



Controllare prima dell'uso per assicurarsi che tutti i requisiti di sicurezza siano pienamente soddisfatti. L'apparecchio non deve essere alimentato o connesso ad altri apparecchi fino a quando le condizioni di sicurezza non sono soddisfatte.

1.1.1 SICUREZZA ELETTRICA

ATTENZIONE



Tutti i collegamenti devono essere isolati da terra nell'ambiente in cui si trovano (la massa non è isolata).

NON collegare nessuna di queste connessioni alla massa.

Per garantire le condizioni di massima sicurezza per l'operatore, si raccomanda di rispettare tutte le indicazioni elencate in questo manuale.

- **Alimentare l'apparecchiatura utilizzando esclusivamente la tensione di rete secondo le specifiche (100 ÷ 240 Vac/dc 50-60 Hz)**
- **Sostituire immediatamente parti danneggiate. Cavi, connettori, accessori o altre parti dell'apparecchio che risultano danneggiate o non correttamente funzionanti devono essere sostituite immediatamente. In simili casi, rivolgersi al centro di assistenza tecnica autorizzato più vicino.**
- **In base a UL, non collegare alle uscite relè una tensione superiore a 115V**

1.2 SIMBOLO DI ATTENZIONE

L'immagine illustrata di seguito rappresenta il simbolo di **ATTENZIONE** e ricorda all'operatore di leggere il manuale d'uso per avere informazioni importanti, consigli e suggerimenti relativi all'uso corretto e sicuro dell'apparecchiatura.

Questo simbolo è utilizzato anche all'interno del software, in particolare nella schermata "misure", per attirare l'attenzione su un evento che verrà spiegato nella pagina successiva della schermata.



In particolare, se posizionato vicino ai punti di collegamento a cavi e periferiche, il simbolo in questione si riferisce all'attenta lettura del manuale d'uso per ricevere istruzioni relative alla natura di tali cavi e periferiche e ai metodi di collegamento corretti e sicuri.

Le riproduzioni dei pannelli dell'apparecchiatura, con i relativi comandi, collegamenti, simboli ed etichette sono disponibili in questo capitolo. Ciascun simbolo di attenzione è accompagnato da una descrizione dettagliata del suo significato.

1.2.1 ATTENZIONE SPECIALE AI COMPONENTI CRITICI

Lo strumento è dotato di un display LCD a cristalli liquidi che contiene piccole quantità di materiali tossici.

1.2.2 SICUREZZA DELL'AMBIENTE DI ESERCIZIO

Il pannello è protetto dalla penetrazione di liquidi. Evitare di sottoporre l'apparecchiatura a eventuali gocciolamenti, spruzzi o immersioni in acqua e di usarla in ambienti in cui tali rischi possono essere presenti. Qualsiasi dispositivo nel quale possa essere entrato accidentalmente del liquido deve essere immediatamente spento, pulito e controllato dal personale autorizzato e qualificato.

Una volta effettuata la programmazione, si consiglia di chiudere il pannello trasparente.

Protezione:

- con pannello trasparente chiuso IP65 EN60529
- con pannello trasparente aperto IP54
- EMI /RFI CEI EN55011 - 05/99
- Utilizzare l'apparecchio entro i limiti ambientali di temperatura, umidità e pressione specificati.

Lo strumento è stato sviluppato per operare nelle seguenti condizioni ambientali:

- Temperatura dell'ambiente di esercizio: $0^{\circ}\text{C} \div +50^{\circ}\text{C}$
- Temperatura di stoccaggio e trasporto: $-10^{\circ}\text{C} \div +50^{\circ}\text{C}$
- Umidità relativa: $10\% \div 95\%\text{UR}$ – senza condensa

ATTENZIONE



L'impianto di trattamento delle acque in cui viene introdotto lo strumento deve essere sviluppato secondo i requisiti funzionali imposti dalla normativa vigente.

L'apparato deve essere perfettamente inserito nell'impianto.

L'impianto deve essere mantenuto operativo nel pieno rispetto delle norme di sicurezza previste.

I parametri indicati sulla scatola degli alimentatori dell'analizzatore devono essere conformi alle normative vigenti.

Eventuali segnali di guasto al dispositivo devono essere posizionati in un ambiente costantemente controllato da personale operativo o assistenti dell'impianto.

Il mancato rispetto anche di una sola di queste condizioni può portare le "logiche" del dispositivo a operare in modo potenzialmente pericoloso per gli utenti del servizio.

Si consiglia pertanto al personale di servizio e/o manutenzione di operare con la massima attenzione, segnalando immediatamente eventuali modifiche ai parametri di sicurezza, al fine di evitare la creazione di situazioni potenzialmente pericolose.

Poiché le considerazioni sopra indicate non possono essere controllate dal prodotto in oggetto, il produttore non sarà ritenuto responsabile per eventuali danni causati da malfunzionamenti a persone o cose.

1.3 CARATTERISTICHE TECNICHE PRINCIPALI

- Misure contemporanee di: Cloro libero, pH, Redox e Temperatura (Opzionale: cloro totale, cloro combinato)
- **Programmazione:** tramite tastiera con 4 tasti a bolla
- LCD STN 240x128 retroilluminato
- Memoria Flash 4 Mbit Data Logger Interno pari a 16000 registrazioni con la possibilità di visualizzare tramite tabelle e grafici l'andamento della misura con l'indicazione dei valori minimo, massimo e medio del periodo
 - **Intervallo di registrazione:** 00:00 ÷ 99:99 min
 - **Tipo:** circolare / riempimento
 - **Visualizzazione:** tabella/grafico
- **P.I.D. Regolazione per uscita pH**
- **Uscita seriale RS485:** Protocollo MODBUS RTU con Baud Rate 1200 ÷ 38400 a velocità programmabile per la configurazione, la condizione in tempo reale o il download dei dati
- N. 4 uscite analogiche:
 - **Quantità:** ppm Cl₂, pH, Redox, Temperatura.
 - **Tipologia:** 0,00 / 4,00 ÷ 20,00 mA isolato galvanicamente
 - **Programmazione limite:** inferiore/superiore/inversione
 - **Carico max:** 500 Ohm
- Allarme uscita conforme a NAMUR 2.4 mA (con intervallo da 4/20mA)
- 2 Uscite relè allarme (mancanza di acqua campione, carenza di reagenti, proiettore bruciato, cella sporca)
- 2 Uscite relè del setpoint 2 per misurazione cloro
- 2 Uscite relè del setpoint 2 per misurazione pH
- 1 Uscita relè del setpoint 2 per misurazione Redox
- 1 Uscita relè del setpoint 2 per misurazione Temperatura (ma anche Cloro totale o combinato su richiesta)

Caratteristiche hardware principali del dispositivo

- La struttura hardware di questa periferica si basa sull'adozione di CPU CMOS di nuovissima generazione con 16 bit, sviluppati appositamente per l'esecuzione delle cosiddette applicazioni "embedded".
- La scheda utilizza una EEPROM per memorizzare i dati di configurazione e memorie flash per la memorizzazione degli archivi dei dati storici e dei file LOG degli eventi.
- La scheda dispone di 1 porta RS485 (optoisolata) per reti locali utilizzata per collegamenti con dispositivi di comunicazione locali (computer di configurazione, terminali, telecomandi ecc.).
- La scheda integra un Real Time Clock (orologio con data) che permette al software di memorizzare le cifre in ordine cronologico.

1.3.1 CARATTERISTICHE TECNICHE

Unità di potenza multiparametro per la determinazione di:
Cloro libero, Cloro totale, pH, Redox, Temperatura e Torbidità

Parametro	Intervallo	Risoluzione	Precisione
Cloro libero	00,00 ÷ 02,00ppm o 10,00ppm Cl ₂	0,01ppm	1% f.s.
Cloro totale	00.00 ÷ 10,00ppm Cl ₂	0,01ppm	1% f.s.
pH	00,00 ÷ 14,00 pH	0,01 pH	1% f.s.
Redox	±1000mV	1 mV	1% f.s.
Temperatura	00,0 ÷ 65,0 °C	0,1°C	1% f.s.
Display grafico	TFT 7" touch resistivo retroilluminato. Visualizzazione simultanea dei valori di misura, stato uscite digitali, stato memorizzazione, malfunzionamenti. Programmazione touch		
Data Logger interno	Flash 32 Mbit Intervallo di registrazione: 00:00 ÷ 99:99 min Tipo: circolare / riempimento Visualizzazione: tabella/grafico		
N. 4 uscite analogiche	ppm Cl ₂ , ppm Cl _{tot} , pH, Temperatura Tipologia: 0,00 / 4,00 ÷ 20,00 mA isolato galvanicamente Programmazione limite: inferiore/superiore/inversione Carico max: 500 Ohm P.I.D. Regolazione		
N. 5 uscite relè del setpoint	N. 2 per Cloro + N. 2 per pH + 1 per Redox Setpoint con isteresi: 00,00 ÷ 05,00 ppm Cl ₂ / 00,00 ÷ 14,00 pH / ± 1500 mV Programmazione di isteresi Carico resistivo max relè 6A a 250Vac		
N. 2 Uscite Relè Allarme	ON-OFF cumulativo per: Min/Max, setpoint Carico resistivo max relè 6A a 250Vac		
Ingressi digitali	Sensore di flusso		
Uscita seriale RS485	Protocollo MODBUS RTU con Baud Rate 1200 ÷ 38400 a velocità programmabile per la configurazione, lo stato in tempo reale o il download dei dati		
Condizioni operative	Temperatura operativa: 0÷50°C Stoccaggio e trasporto: -25÷65°C Umidità 10-95% senza condensa		
Alimentazione/ Protezione elettrica	Alimentazione: 90÷260Vac/dc 50-60Hz Assorbimento medio: 30 W Protezione elettrica:		
Alloggiamento	Alloggiamento a piastra singola in ABS		

2 DESCRIZIONE GENERALE

La serie di Pannelli Guardian **Pool_NN** comprende i seguenti modelli:

N.	Modello	Codice	Descrizione
1	Guardian Pool_NN 1 Cloro libero 10 ppm	72700	Con sensore per cloro organico ⁽²⁾ 0-10 ppm
2	Guardian Pool_NN 2 Acqua potabile Cloro libero 2 ppm	72701	Con sensore per cloro organico ⁽²⁾ 0-2 ppm
3	Guardian Pool_NN 3 pH e Cloro libero	- 72702	- pH - Cloro organico libero ⁽²⁾ 0-10 ppm.
4	Guardian Pool_NN 4 pH – ORP	- 72703	- pH - Sensore ORP, in elettrodo dorato (Sensorex)
5	Guardian Pool_NN 5 pH – ORP – Cloro libero	- 72704	- pH - Sensore ORP, in elettrodo dorato (Sensorex) - Cloro organico libero ⁽²⁾
6	Guardian Pool_NN 6 pH, ORP, cloro libero, cloro totale, cloro combinato. Ingresso per NTU (4- 20mA)	- 72705	- pH - Sensore ORP, in elettrodo dorato (Sensorex), - Cloro libero - Cloro totale - Sensore di torbidità
7	Guardian Pool_NN 7 pH, ORP, cloro libero, Torbidità Ingresso per NTU (4- 20mA)	- 74720	- pH - Cloro libero - Sensore di torbidità

NOTE:

(¹) Nella versione ppm, con la conversione in **Bromuro** (fattore di conversione 2,4) nell'attrezzatura reale, il cliente può selezionare la lettura Cloro o Bromuro.

(²) Questo sensore può leggere **NaClO** (ipoclorito di sodio), **Ca(ClO)₂** (ipoclorito di calcio), **Cl₂** (gas di cloro), cloro generato elettroliticamente e cloro organico combinato a base di acido isocianurico (testato fino a concentrazione di acido cianurico di 500 mg/l).

3 PROGRAMMAZIONE

Questo manuale contiene tutte le informazioni per l'utilizzo dello schermo di strumentazione. Verranno analizzate tutte le finestre operative, con foto e spiegazioni.

3.1 SCHERMATA PRINCIPALE



Figura 1 Schermata principale

3.1.1 GENERAL SETTINGS (IMPOSTAZIONI GENERALI)

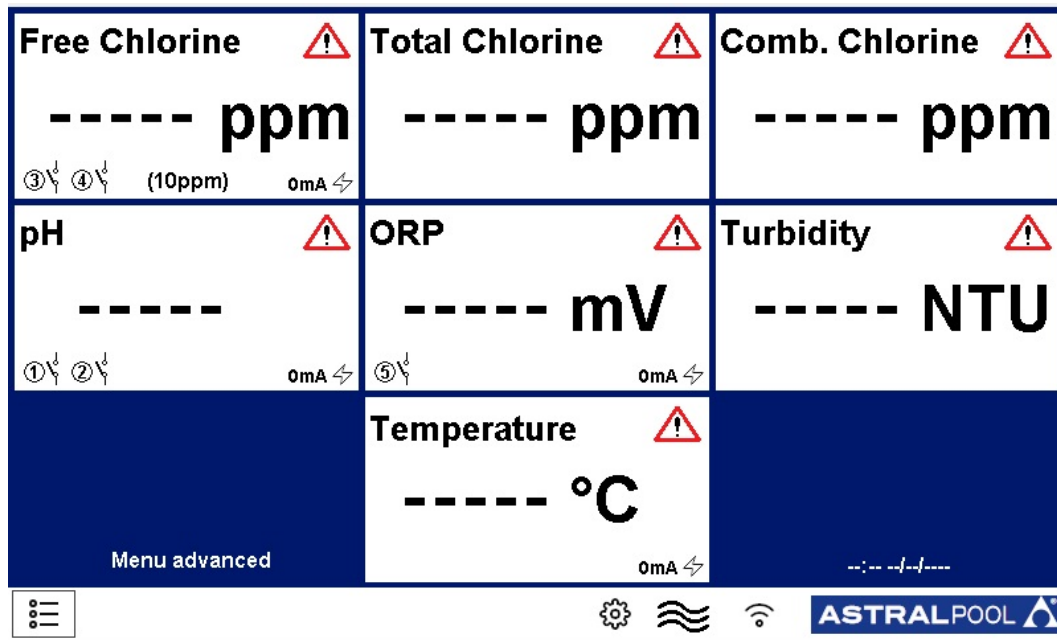

Figura 2 Impostazioni generali

- **Archive (Archivio):** modalità per salvare i dati
 - **STEP (FASE):** Sceglie la frequenza in cui il sistema acquisisce dati (minuti).
 - **TYPE (TIPO):** Decide il tipo di archivio dati:
 - **Circle (Cerchio):** Acquisisce dati in modalità FIFO.
 - **Finite (Finito):** Acquisisce dati fino quando è pieno. Quindi deve essere svuotato.
 - **Reset (Reinizializzazione):** Azzera i dati salvati.
 - **Save on pen drive (Salva su pen drive):** Il sistema salva i dati sulla porta USB.
 - **View record (Visualizza archiviazione):** Mostra i dati archiviati.
 - **Alarms Log (Registro allarmi):** Mostra la cronologia allarmi.

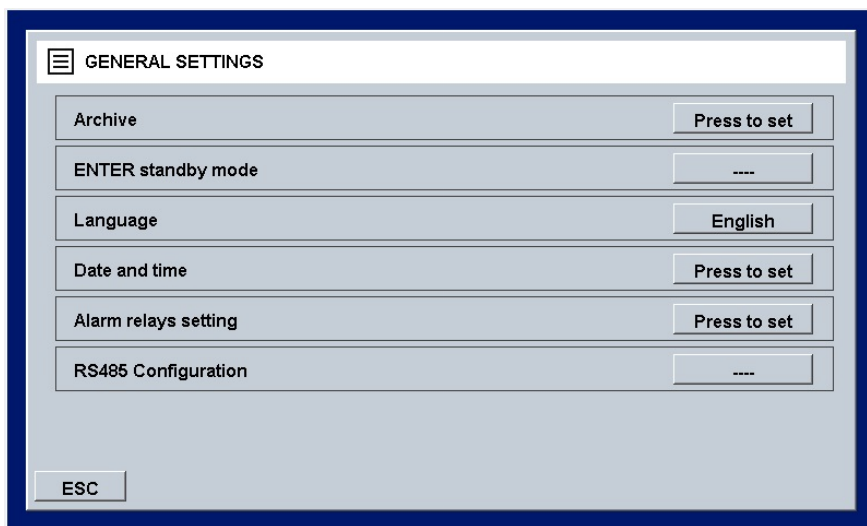

Figura 3 Impostazioni archivio

- **ENTER standby mode (ACCEDI modalità standby)**
Il sistema passa in standby, misura, ma non esegue dosaggi o comandi.
- **Language (Lingua):**
Imposta la lingua operativa (inglese).
- **Date and time (data e ora):**
Imposta data e ora visualizzate sulla finestra principale.

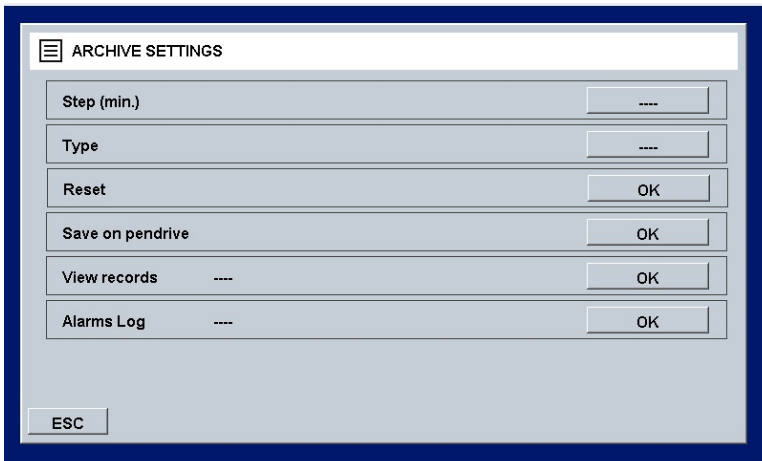

Figura 4 Data e ora

- **Alarm relays setting (Impostazione relè allarme)**

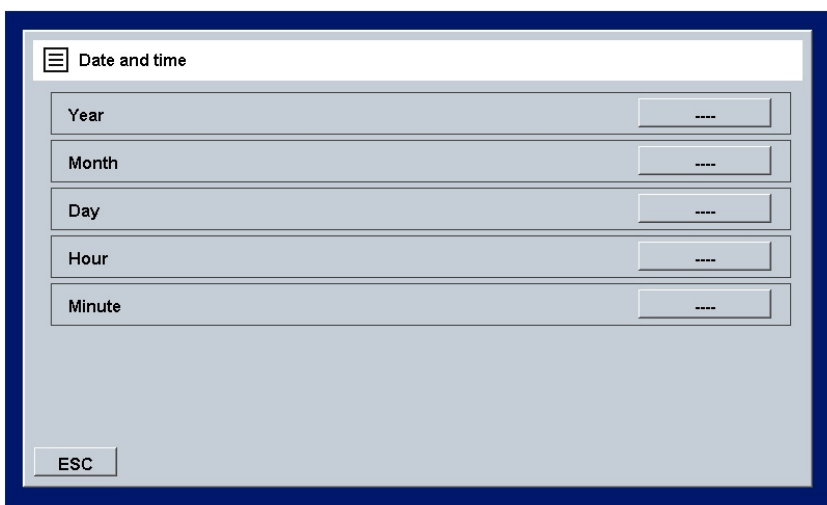

Figura 5 Data e ora

Esistono due relè di allarme e sono assegnabili:

- **ALARM RELAY ASSIGN (ASSEGNA RELÈ ALLARME):** Scegli la misura alla quale assegnare il relè; è possibile scegliere tra: tutte le misure, Combina Setpoint Cloro o Setpoint Torbidità
- **ALARM RELAY STATUS (STATO RELÈ ALLARME):** Consente di scegliere lo stato normale del relè:
NO (Normalmente aperto)
NC (Normalmente chiuso)
- **ALARM RELAY DELAY (SEC) (RITARDO RELÈ ALLARME (SEC)):** Selezionare il tempo (secondi) dopo il quale il relè cambia il proprio stato.

3.1.2 FACTORY SETTINGS (PARAMETRI DI FABBRICA)

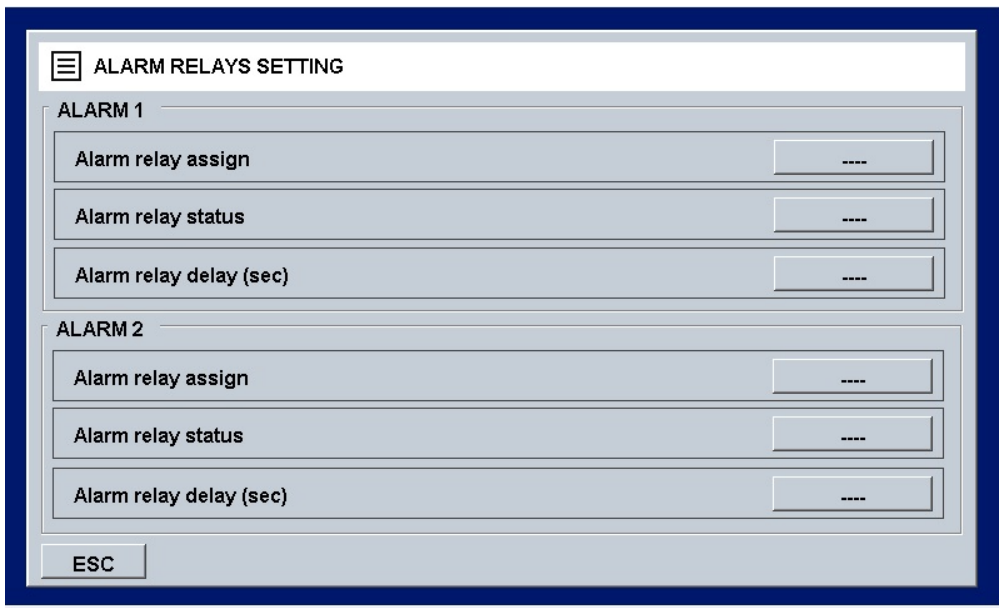

Questa finestra è protetta da password. La spiegazione si trova nell'appendice.

3.1.3 FLOW (FLUSSO)



Sono disponibili due stati:

 - ON: in presenza di flusso.

 - OFF: in assenza di flusso.

3.1.4 WI-FI

Questa icona mostra la presenza di una connessione Wi-Fi LAN.
Per collegare al rete Wi-Fi LAN seguire i punti riportati di seguito:

- 1) Collegarsi al wi-fi SSID-XXXX con un telefono o un PC; la password di rete è: **1234567890**
- 2) Avviare un browser e collegarsi all'indirizzo: **192.168.4.1** e usare i seguenti dati per fare il login:
 - Username: **admin**
 - Password: **0000**
- 3) Una volta connessi, assicurarsi che nella parte in alto a sinistra del dashboard, accanto a **Up since_** compaia la data e l'ora in cui la scheda è stata accesa



Figura 6 Menu Setpoint

3.1.5 DATA AND TIME (DATA E ORA)

10:00 03/05/2019

Mostra la data e l'ora impostate nella finestra del menu.

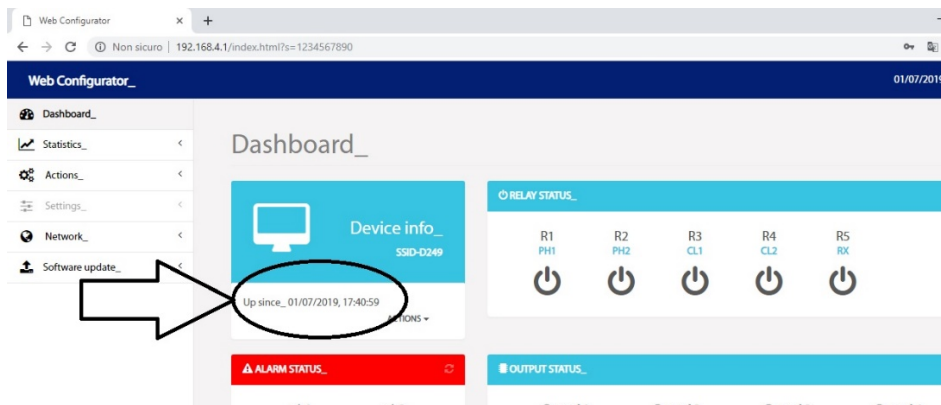
3.2 MEASURES (MISURE)



Figura 7 Finestra principale

Quando si tocca il tab della misura nella finestra principale, questo si apre (Figura 7):

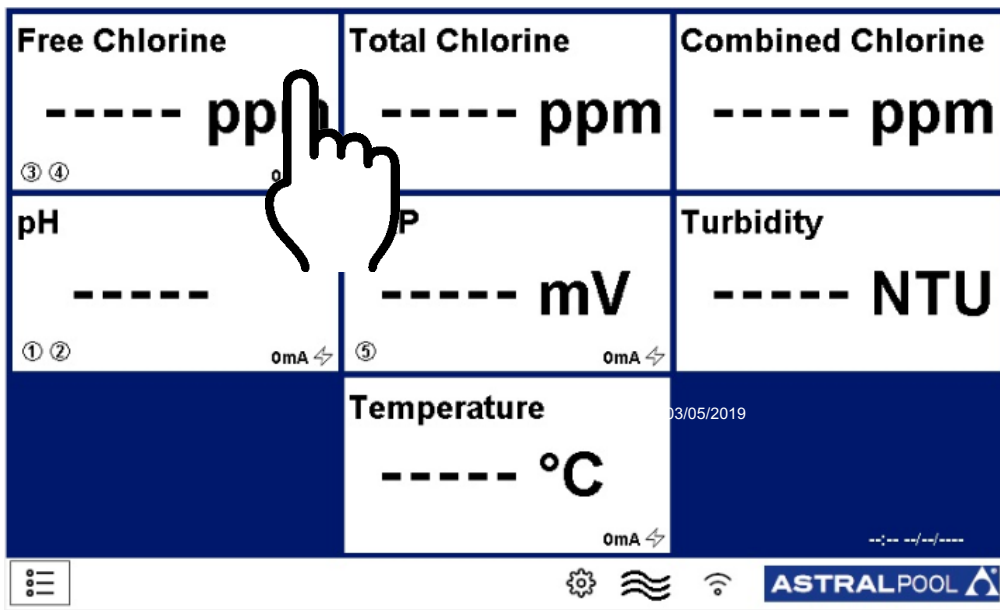

Figura 8 Menu Misura

Questa finestra è la stessa per tutte le misure.

3.2.1 SETPOINT

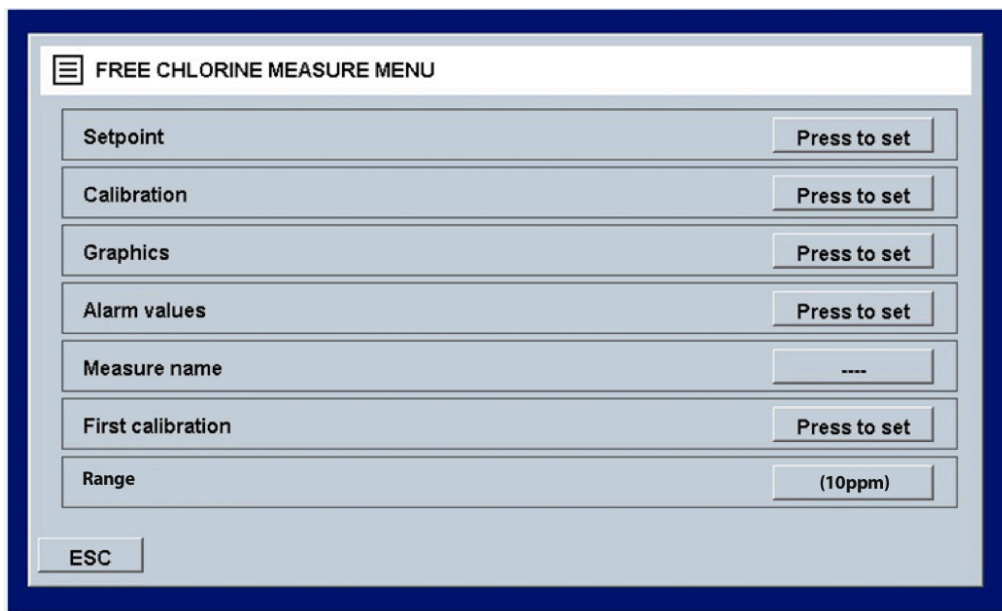
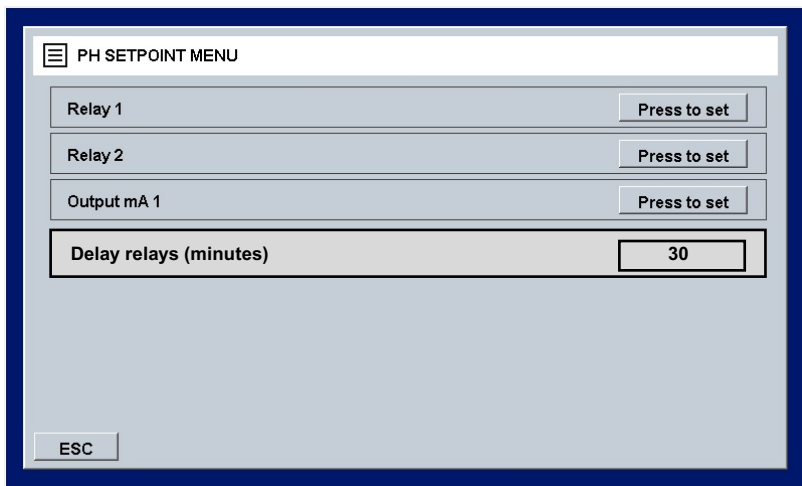

Nota:

il menù "ritardo relè" ha effetto solo sui Relè 3 e 4 del cloro libero, si attiva all'accensione dello strumento, ha la funzione di attendere un tempo di polarizzazione della sonda cloro libero, nella schermata principale viene visualizzata una clessidra. 

Figura 9 Menu Setpoint

- **Relays (Relè)**

Il numero di relè utilizzabili è diverso per le misure:

- **Relè n. 1, 2 pH;**
- **Relè n. 3, 4 Cloro libero;**
- **Relè n. 5 Rx;**



Figura 10 Menu Setpoint relè

Si tratta della finestra dedicata al relè:

SETPOINT: Imposta il valore del setpoint in ppm

HYSTERESIS (ISTERESI): Imposta l'intervallo intorno al setpoint (l'intervallo è isteresi ± setpoint)

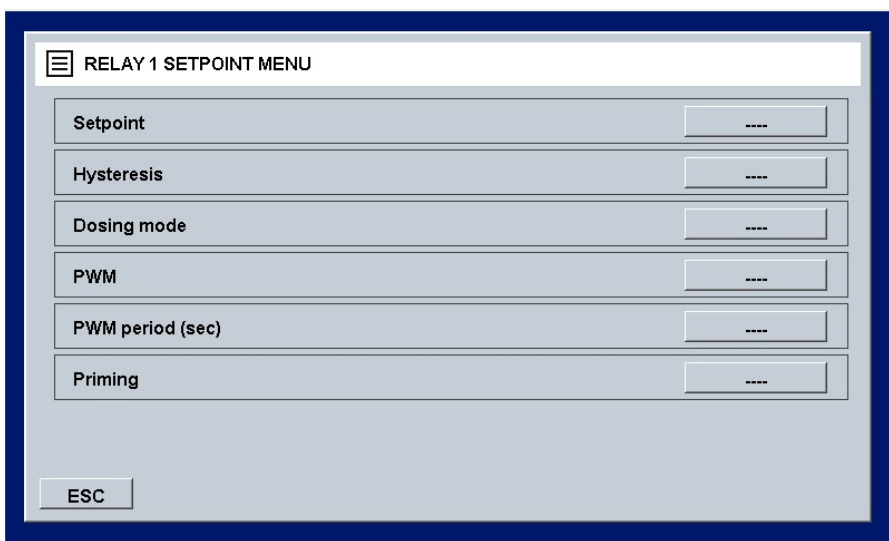
DOSING MODE (MODALITÀ DOSAGGIO): Imposta la modalità Relè:

- **HIGH (ALTO):** Il relè si chiude quando la misura è inferiore a setpoint ± isteresi e si apre quando la misura è superiore a setpoint ± isteresi
- **LOW (BASSO):** Il relè si apre quando la misura è inferiore a setpoint ± isteresi e si chiude quando la misura è superiore a setpoint ± isteresi

Priming (Adescamento): E' possibile attivare manualmente le pompe dosatrici relative ai prodotti.

HIGH/LOW examples (Esempi ALTO/BASSO):



Figura 1 Menu Setpoint relè

Rappresenta la scelta di aumentare il valore della misurazione quando scende al di sotto di un valore selezionato.

Il relè si chiude se il valore della misura è inferiore al minimo dell'intervallo e si apre quando ritorna al massimo dell'intervallo.

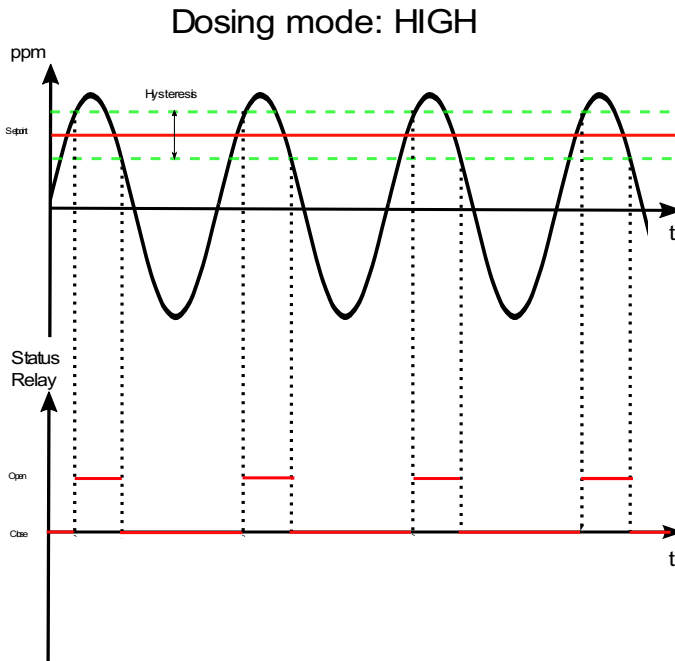

Figura 2 Menu Setpoint relè

Rappresenta la scelta di diminuire il valore della misurazione quando sale sopra a un valore selezionato.

Il relè si chiude quando il valore della misura è superiore al massimo dell'intervallo e si apre quando ritorna al minimo dell'intervallo

- **OUTPUT mA (USCITA mA)**

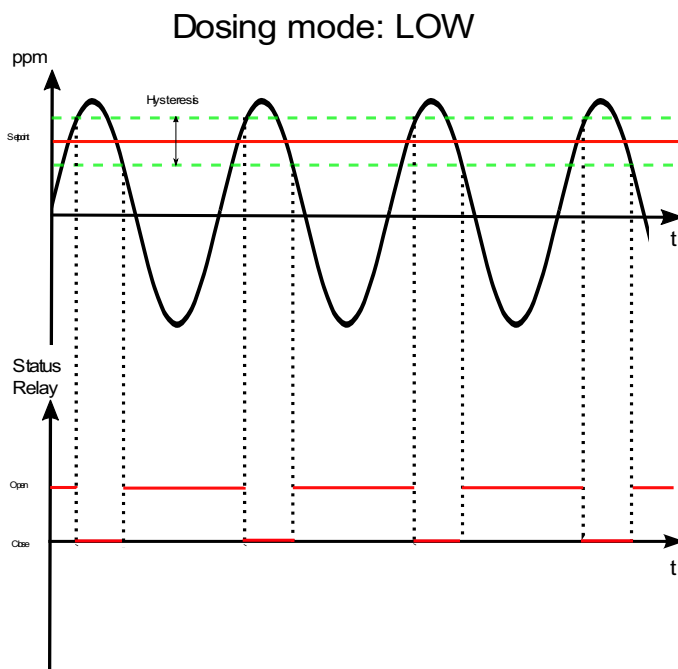
Il numero mA di USCITE utilizzabili è diverso per le misure:

- **Uscita mA 1 pH;**
- **Uscita mA 2 Cloro libero;**
- **Uscita mA 3 Rx;**
- **Uscita mA 4 Temperatura;**



Figura 53 Menu impostazione uscite

Si tratta della finestra riservata all'uscita mA:

LOW limit (Limite BASSO): Imposta il valore minimo dell'uscita.

HIGH limit (Limite ALTO): Imposta il valore massimo dell'uscita.

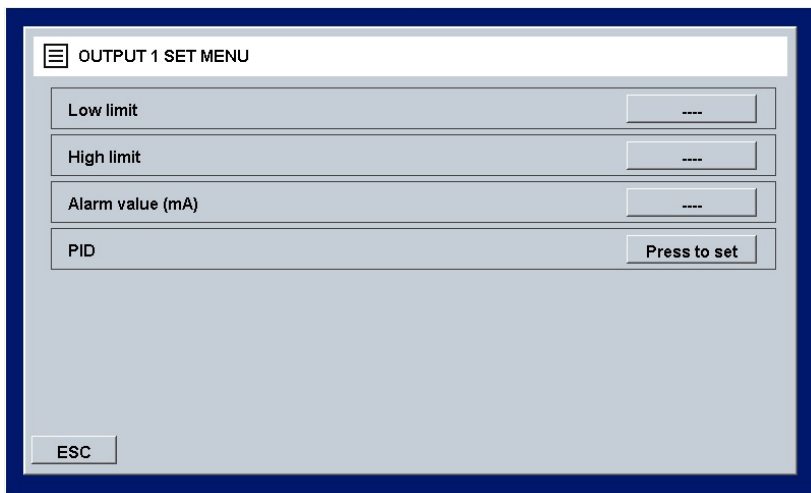
Alarm value (mA) (Valore allarme (mA)): Imposta quel valore che, se superato, genera un allarme.

PID: Premere per aprire la finestra del PID



Figura 14 Menu impostazione PID

PID: Abilita il PID sull'uscita (ON/OFF).

PID Set point (Setpoint PID): Imposta il setpoint del PID.

PID algorithm (Algoritmo PID): Imposta il tipo di PID (P/I/D).

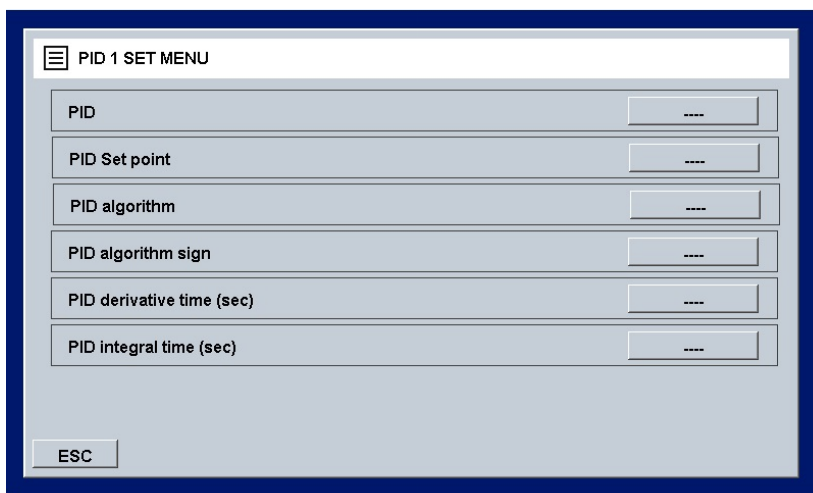
PID algorithm sign (Segno algoritmo PID): Imposta il tipo di controllo (diretto/inverso).

- **Logic Max value / Logic Min. Value (Valore min/max logica)**

Se l'isteresi non è presente, è possibile impostare i limiti superiore e inferiore; se la misura supera questi valori, viene generato un allarme.

3.2.2 CALIBRATION (CALIBRAZIONE)



Figura 15 Calibrazione

Questo tab mostra il metodo di calibrazione per le misurazioni; seguire le istruzioni sullo schermo: Inserire la sonda nel tampone, attendere che la misura sia stabile (nelle aree cerchiata), quindi premere OK. Si apre la seguente finestra:

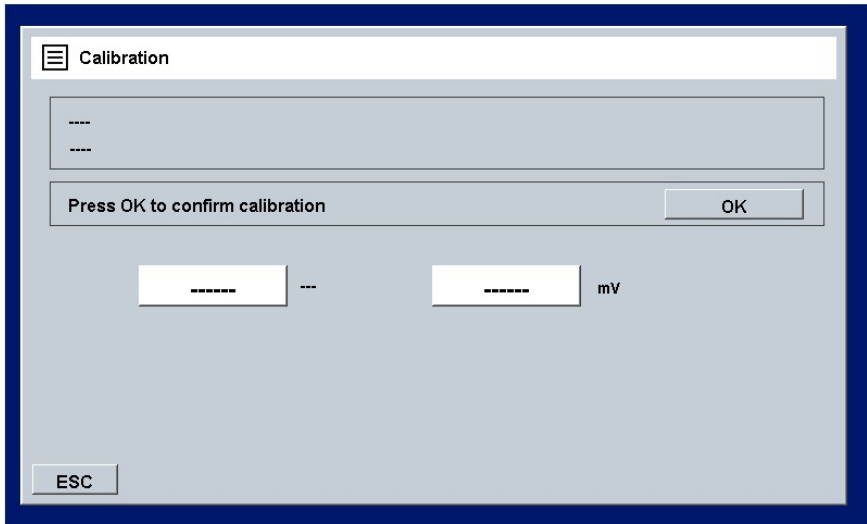

Figura 66 Imposta valore

Impostare il valore del tampone e premere OK.

Solo il pH richiede una calibrazione a 2 punti (con soluzioni tampone pH 4 e pH 7): Premendo il tasto "Calibrate" (Calibra), si apre al finestra delle altre calibrazioni.

3.2.3 GRAPHICS (GRAFICI)

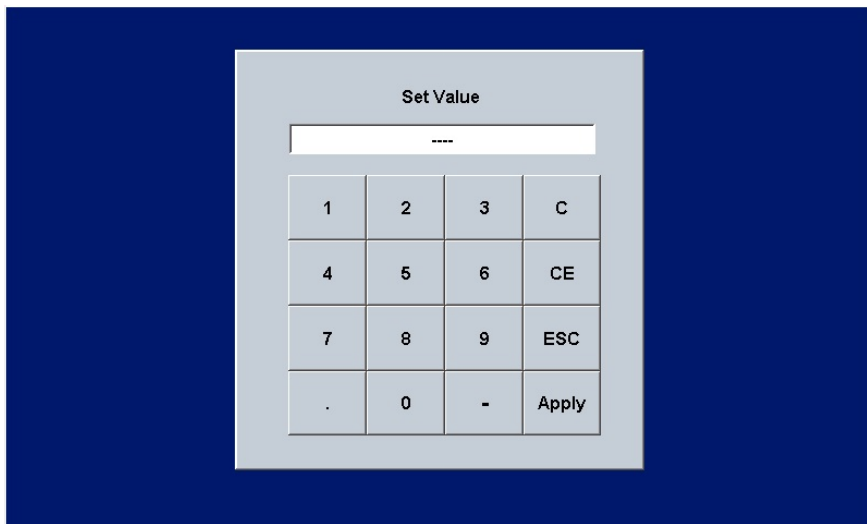

Figura 7 Menu Grafici

- **Min value on diagram (Valore min su diagramma):** Imposta il valore minimo sul grafico
- **Max value on diagram (Valore max su diagramma):** Imposta il valore massimo sul grafico
- **Graph time setting (Impostazione tempo grafico):** Imposta gli assi temporali
- **Graphics (Grafici):** Premere per visualizzare il grafico (figura 18)

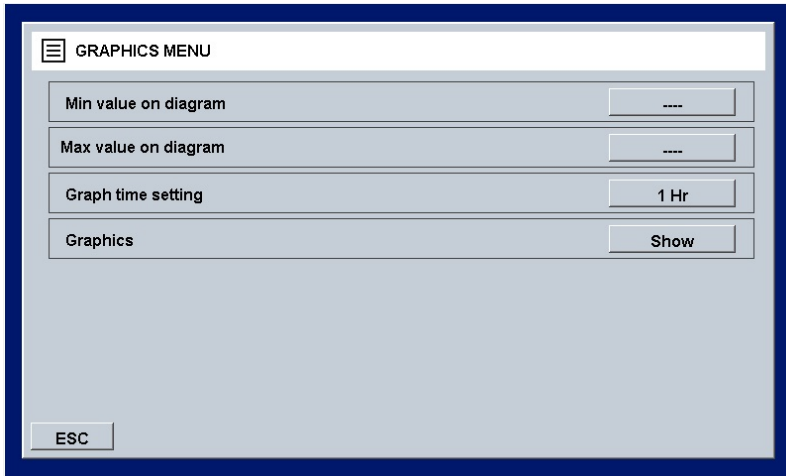

Figura 8 Grafico

3.2.4 ALARM VALUES (VALORI ALLARMI)

Imposta il valore min/max sopra/sotto il quale si attiva l'allarme

3.2.5 MEASURE NAME (NOME MISURE)

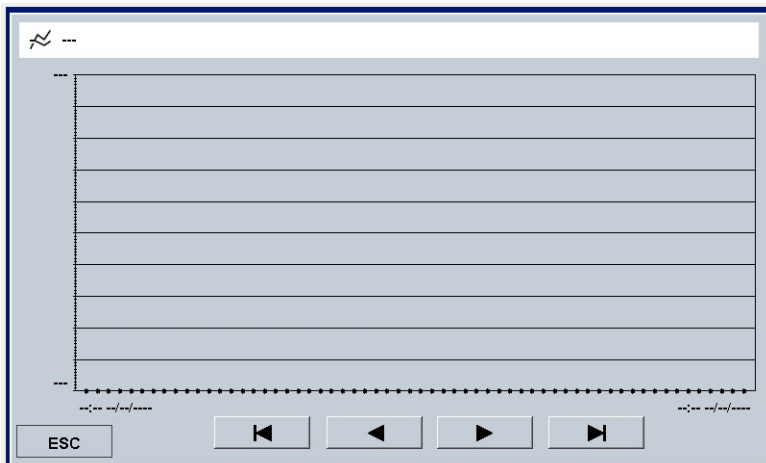
Consente di modificare il nome della misura nel relativo tab

3.2.6 FIRST CALIBRATION (ULTIMA CALIBRAZIONE)

Esegue la prima calibrazione solo dopo un'attesa di 90 minuti

3.2.7 RANGE (INTERVALLO)

Imposta l'intervallo di misura operativo della sonda.

4 INSTALLAZIONE

Prima di installare il **multiparametro AstralPOOL**, leggere attentamente quanto segue. Questa sezione descrive i vari passaggi per l'installazione dell'apparecchiatura e del cablaggio elettrico. Seguire queste indicazioni durante l'installazione.

- Prima di iniziare il lavoro assicurarsi che l'attrezzatura e tutti i relativi dispositivi siano spenti.
- In caso di anomalie o segnali di avvertimento, fermarsi immediatamente. Riprendere il lavoro solo dopo aver rimosso la causa del problema.
- Non installare l'apparecchiatura in luoghi pericolosi o in aree a rischio di incendio o esplosione.
- Evitare rischi elettrici. Non utilizzare mai apparecchiature danneggiate o difettose.

4.1 KIT DI INSTALLAZIONE

	 1: Viti di fissaggio (ϕ =viti da 6 mm)	 2: Tubo trasparente in PVC 8x12 (4 m)	 3: Porta sonda	 4: Connettori
	 5: Sonda cloro libero 2 ppm	 6: Sonda cloro libero 10 ppm	 7: Sonda cloro totale 10 ppm	 8: Cavo per sonda cloro (1m)
	 9: sonda pH	 10: sonda Redox	 11: soluzioni tampone pH	 12: soluzione tampone ORP
 13: Cartucce filtro	 14: Sistema di controlavaggio	 15: Porta sonda torbidità PSS8	 16: Sonda torbidità	 17: Sensore di temperatura
			 18: Cavo e sonda di conducibilità	

N	Componente	Pool_NN	Pool_NN	Pool_NN	Pool_NN	Pool_NN	Pool_NN	Pool_NN
		1	2	3	4	5	6	7
	Codice	72700	72701	72702	72703	72704	72705	74720
1	Viti di fissaggio	•	•	•	•	•	•	•
2	Tubo PVC 8X12 da 4 metri	•	•	•	•	•	•	•
3	Porta sonda	•	•	•	•	•	•	•
4	Connettori	•	•	•	•	•	•	•
5	Sonda cloro libero 2 ppm		•					
6	Sonda cloro libero 10 ppm	•		•		•	•	•
7	Sonda cloro totale 10 ppm						•	
8	Cavo cloro 1 metro	•(x1)	•(x1)	•(x1)		•(x1)	•(x2)	•(x1)
9	Sonda pH			•	•	•	•	•
10	Sonda Redox				•	•	•	
11	Soluzione tampone pH7 e pH4			•	•	•	•	•
12	Soluzione tampone Redox 465 mV				•	•	•	
13	Filtro cartuccia 80 μ m	•	•	•	•	•	•	•
14	Sistema di controlavaggio	(*1)	(*1)	(*1)	(*1)	(*1)	(*1)	(*1)
15	Porta sonda torbidità PSS8						•	
16	Sonda torbidità						•	
17	Sonda Temperatura	•	•	•	•	•	•	•
18	Cavo e sonda di conducibilità	(*1)	(*1)	(*1)	(*1)	(*1)	(*1)	(*1)

(*1 su richiesta).

4.2 MONTAGGIO A PARETE

Installare la centralina lontano da fonti di calore, in luogo asciutto, senza spruzzi d'acqua, al riparo da gocciolamenti e a temperature inferiori a 40°C. La temperatura minima non deve essere inferiore a 0 ° C. La centralina deve essere installata facendo in modo di lasciare spazio sufficiente per i cavi e le connessioni.

Il pannello posteriore dell'unità di controllo è provvisto di 4 fori in prossimità degli angoli per il fissaggio a parete dell'unità. La figura seguente mostra la posizione dei fori e le dimensioni massime del pannello.



Figura 9 Montaggio a parete del sistema

Se adeguati come supporto, utilizzare i tasselli in dotazione, altrimenti sceglierne un tipo adatto. L'unità viene fornita già assemblata e cablata internamente.

Per garantire un supporto ottimale del sistema, il muro deve essere il più diritto e uniforme possibile.

Praticare due fori allineati orizzontalmente a un'altezza che consenta all'operatore di avere una corretta visuale del pannello di controllo e una posizione idonea per le operazioni di calibrazione e controllo.

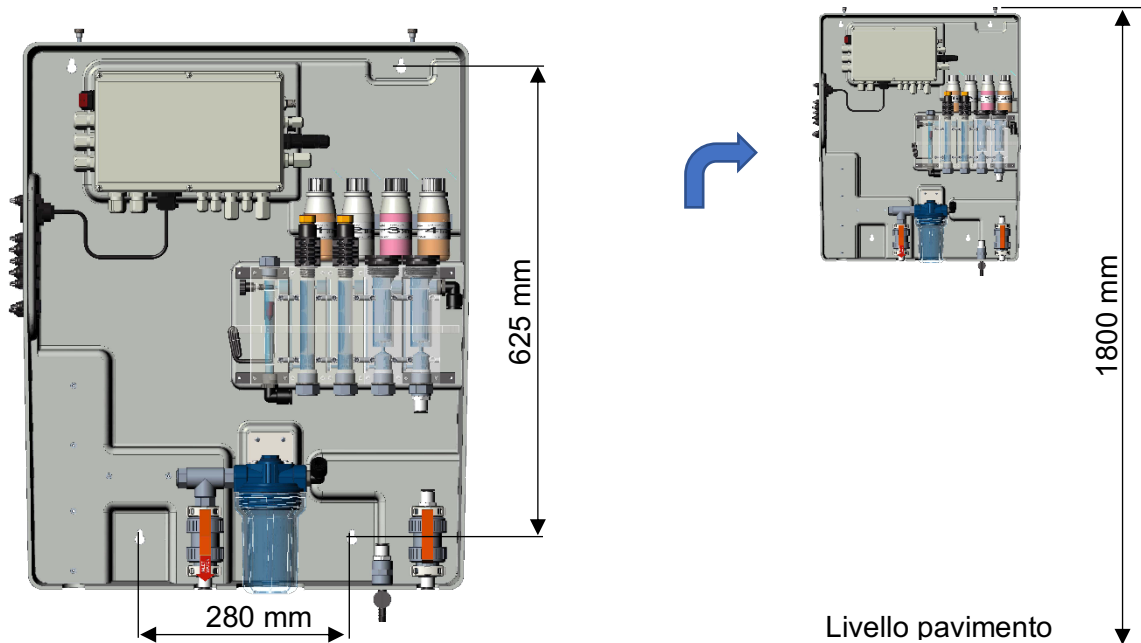
L'altezza da terra consigliata è di circa 180 cm o almeno all'altezza degli occhi.

La distanza tra i fori è indicata nella foto sopra.

Utilizzare una livella a bolla d'aria durante l'installazione per livellare correttamente l'unità di controllo.

Le dimensioni totali dell'involucro sono: 730x600x230 mm (H x L x P)



Figura 10 Dimensioni del sistema

4.3 MORSETTIERA DI COLLEGAMENTO

Prima di installare il multiparametro Astralpool, leggere attentamente quanto segue



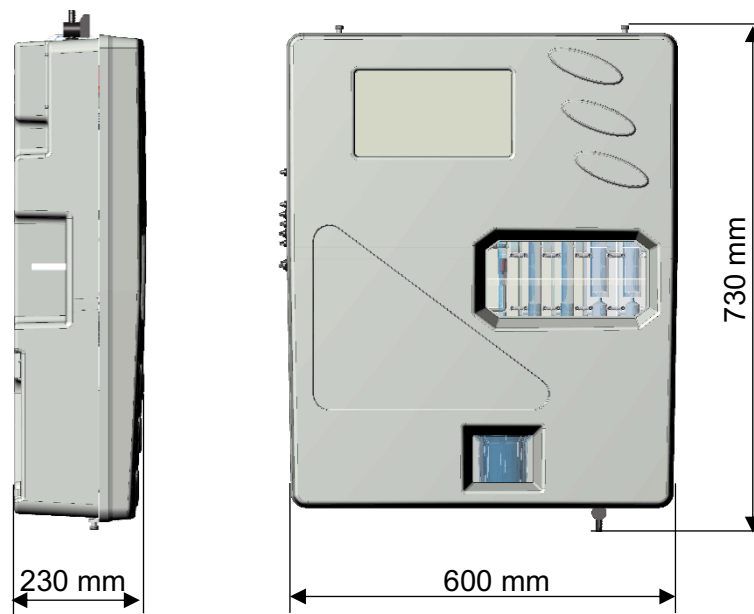







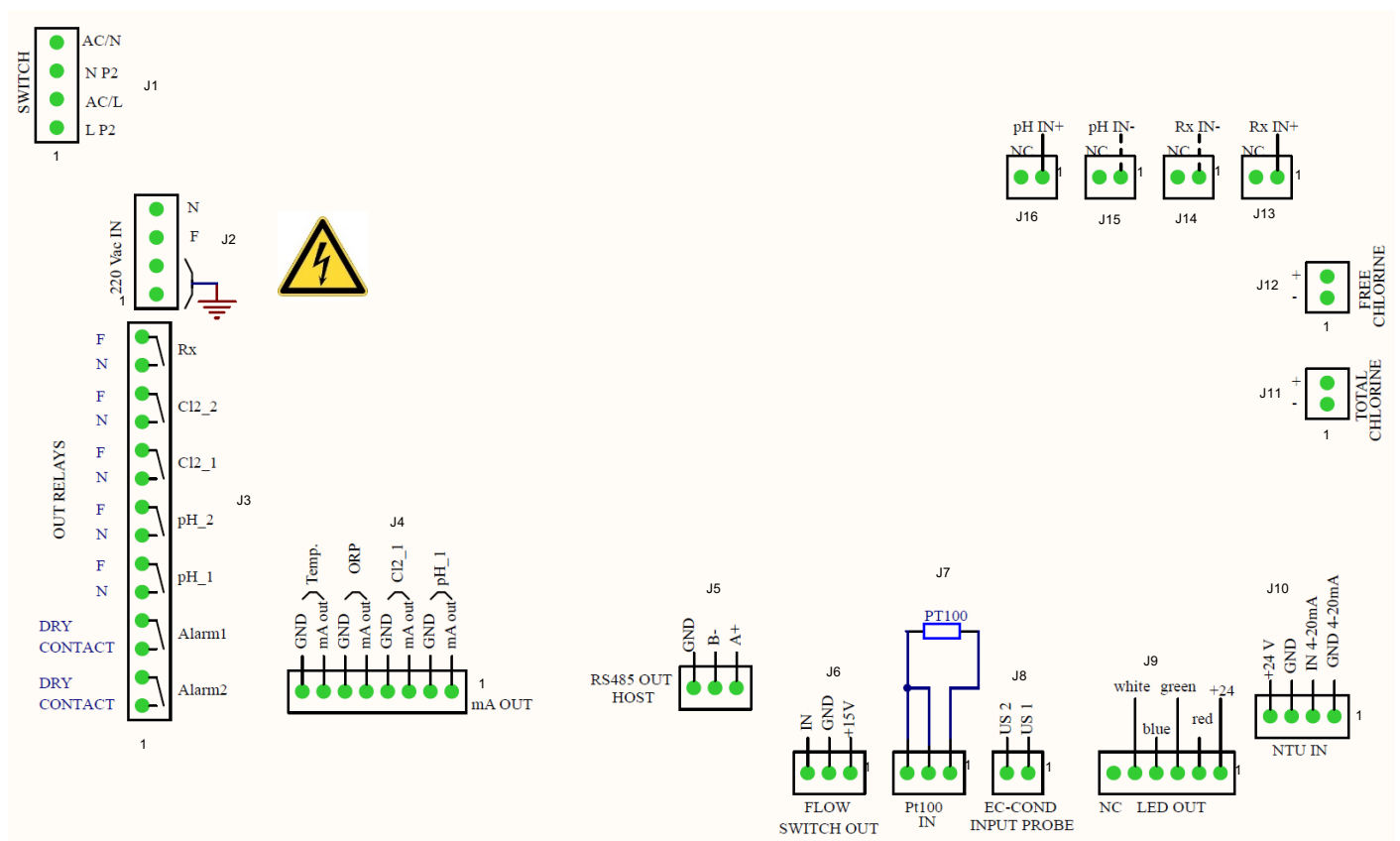
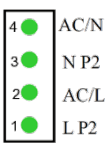
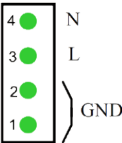









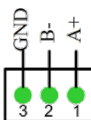
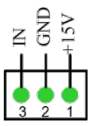

Figura 11 Collegamenti

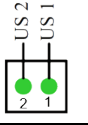
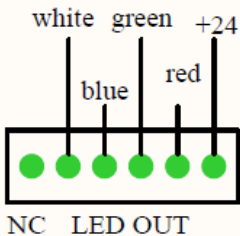
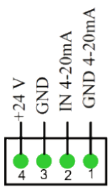
Connettore	Morsetto	FIGURA	DESCRIZIONE	
J1	1		Cavo neutro alimentazione elettrica AC	
	2		Cavo neutro 220 Vac	
	3		Cavo linea alimentazione AC	
	4		Cavo linea 220 Vac	
J2	1		Cavo di terra 1	
	2		Cavo di terra 2	
	3		Cavo linea alimentazione 220 Vac	
	4		Cavo neutro alimentazione elettrica 220 Vac	
J3	1	ALLARME 2 	Relè di allarme remoto (2)	Contatto pulito
	2		Relè di allarme remoto (2)	
	3	ALLARME 1 	Relè di allarme remoto (1)	Contatto pulito
	4		Relè di allarme remoto (1)	
	5	pH_1 	Setpoint pH 1	Contatto alimentato (100-240Vac)
	6		Setpoint pH 1	
	7	pH_2 	Setpoint pH 2	Contatto alimentato (100-240Vac)
	8		Setpoint pH 2	
	9	Cl2_1 	Setpoint 1 Cl ₂	Contatto alimentato (100-240Vac)
	10		Setpoint 1 Cl ₂	
	11	Cl2_2 	Setpoint 2 Cl ₂	Contatto alimentato (100-240Vac)
	12		Setpoint 2 Cl ₂	
	13	Rx 	Setpoint Rx	Contatto alimentato (100-240Vac)
	14		Setpoint Rx	
J4	1	pH_1 	Cavo positivo pH mA	
	2		Cavo negativo pH mA	
	3	Cl2_1 	Cavo positivo Cl ₂ mA (1)	
	4		Cavo negativo Cl ₂ mA (1)	
	5	ORP 	Cavo positivo ORP mA	
	6		Cavo negativo ORP mA	
	7	Temp 	Cavo positivo temperatura mA	
	8		Cavo negativo temperatura mA	
J5	1		Interfaccia RS485 (A+)	
	2		Interfaccia RS485 (B-)	
	3		Interfaccia RS485 (terra)	

(*¹ Il relè di allarme può essere impostato su: Misura Allarme All, Setpoint CL Comb; Setpoint Torbidità)

Connettore	Morsetto	FIGURA	DESCRIZIONE	
J6	1		Cavo +15 V	
	2		Cavo di terra	
	3		Cavo ING	
J7	1		Cavo connessione PT 100	
	2		Cavo connessione PT 100	
	3		Cavo connessione PT 100	
J8	1		Sonda EC-Cond (conducibilità elettrica)	Cavo μ S 1
	2			Cavo μ S 2
J9	1		+24V	
	2		Rosso	
	3		Verde	
	4		Blu	
	5		Bianco	
	6		NC	
J10	1		Sonda torbidità	4-20 mA (terra)
	2			4-20 mA (IN)
	3			Alimentazione 24 V-
	4			Alimentazione 24 V+
J11	1		Sonda cloro totale	Cavo negativo Cl_{tot}
	2			Cavo positivo Cl_{tot}
J12	1		Sonda Cloro libero	Cavo negativo Cl_2
	2			Cavo positivo Cl_2
J13	1		Sonda ORP	RG 174 Rx (IN +)
	2			
J14	1			RG 174 Rx (IN -)
	2			
J15	1		Sonda pH	RG 174 pH (IN -)
	2			
J16	1			RG 174 pH (IN +)
	2			

4.4 COLLEGAMENTI ELETTRICI

Connessioni morsetti:

N	Componente	Funzione	Pool_NN	Pool_NN	Pool_NN	Pool_NN	Pool_NN	Pool_NN	Pool_NN
			1	2	3	4	5	6	7
Codice			72700	72701	72702	72703	72704	72705	74720
1	100-240Vac 50-60Hz	Alimentazione elettrica	•	•	•	•	•	•	•
2	Relè 1 (pH1)	Azione dosaggio alimentata			•	•	•	•	•
3	Relè 2 (pH2)	Azione dosaggio alimentata			•	•	•	•	•
4	Relè 3 (CL1)	Azione dosaggio alimentata	•	•	•		•	•	•
5	Relè 4 (CL2)	Azione dosaggio alimentata	•	•	•		•	•	•
6	Relè 5 (Rx)	Azione dosaggio alimentata				•	•	•	
7	Relè 6 (Alr1)	Contatto pulito stato allarme	•	•	•	•	•	•	•
8	Relè 7 (Alr2)	Contatto pulito stato allarme	•	•	•	•	•	•	•
9	mA1 (pH)	Uscita mA			•	•	•	•	•
10	mA2 (Cl)	Uscita mA	•	•	•		•	•	•
11	mA3 (Rx)	Uscita mA				•	•	•	
12	mA4 (°C)	Uscita mA	•	•	•	•	•	•	•
13	Porta seriale RS485	Comunicazione	•	•	•	•	•	•	•
14	Ingresso Reed	Ingresso stato flusso	•	•	•	•	•	•	•
15	Sonda pH	Segnale mV ingresso			•	•	•	•	•
16	Sonda1 CL	Segnale mA ingresso	•	•	•		•	•	•
17	Sonda2 CL	Segnale mA ingresso						•	
18	Sonda torbidità	Segnale mA ingresso						•	•
19	Sonda Rx	Segnale mV ingresso				•	•	•	
20	Sonda temp.	Segnale Ohm ingresso	•	•	•	•	•	•	•
21	Uscita 5 VDC	Alimentazione elettrica per Led rosso	•	•	•	•	•	•	•
22	Connessione Wi-Fi	Connessione Wi-Fi	•	•	•	•	•	•	•
23	Sonda di conducibilità	Segnale mV ingresso	•	•	•	•	•	•	•

4.5 COLLEGAMENTI IDRAULICI



Figura 12 Collegamenti idraulici

4.6 COLLEGAMENTO SONDE

4.6.1 COLLEGAMENTO SONDA PH E REDOX

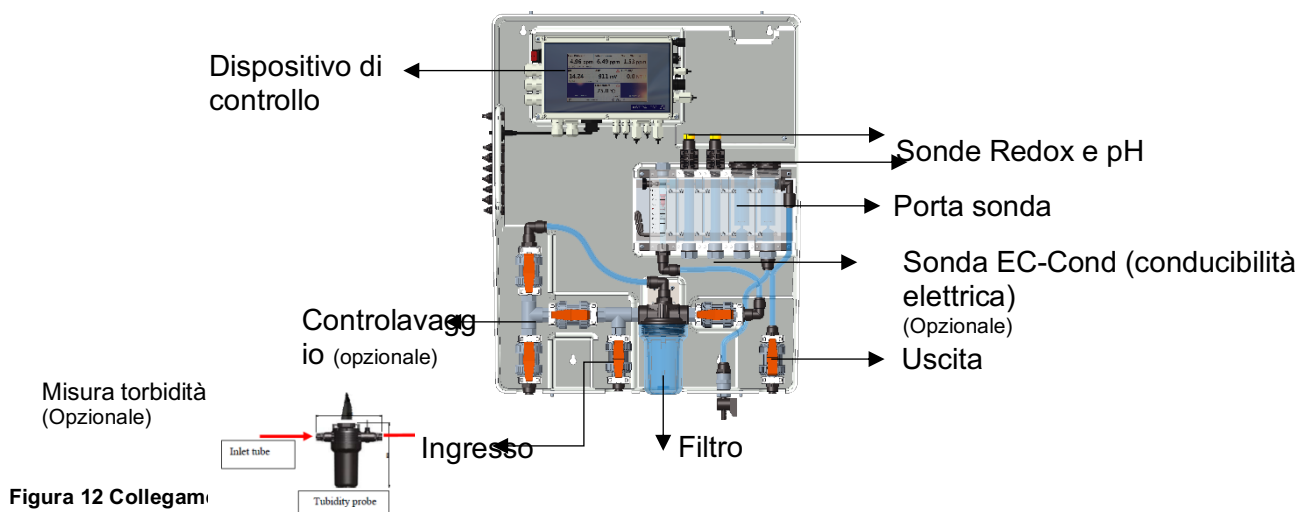

Figura 13 Connettori pH e Redox

4.6.2 COLLEGAMENTO DELLA SONDA DI CONDUCEBILITÀ

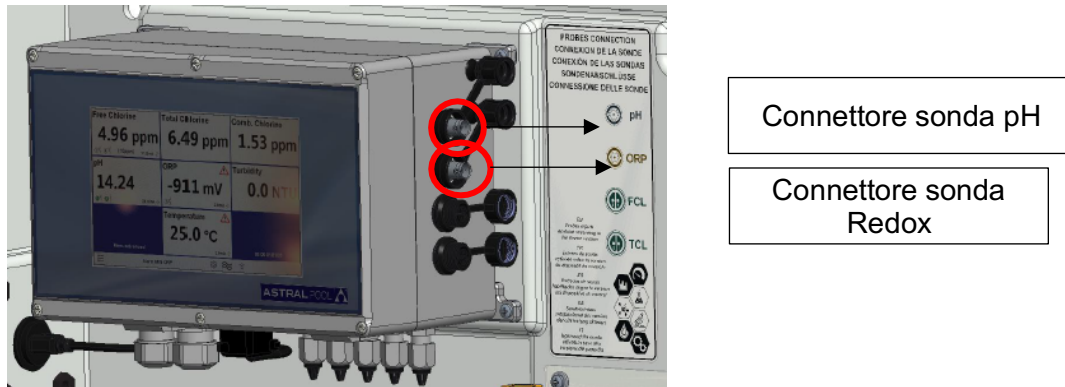

Figura 14 Connettore di conducibilità

4.6.3 COLLEGAMENTO DELLA SONDA DEL CLORO

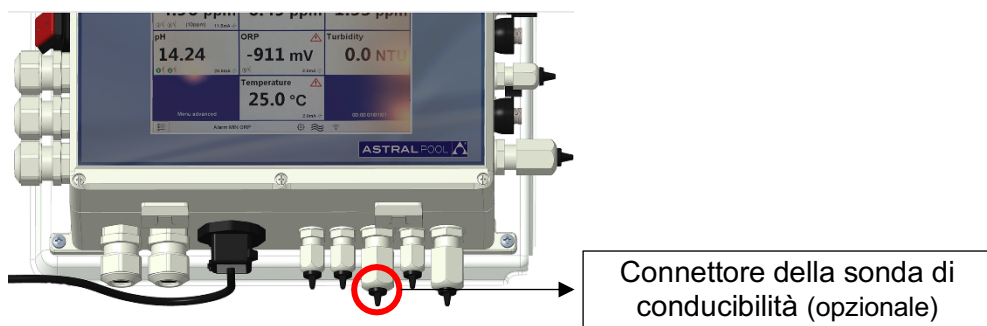
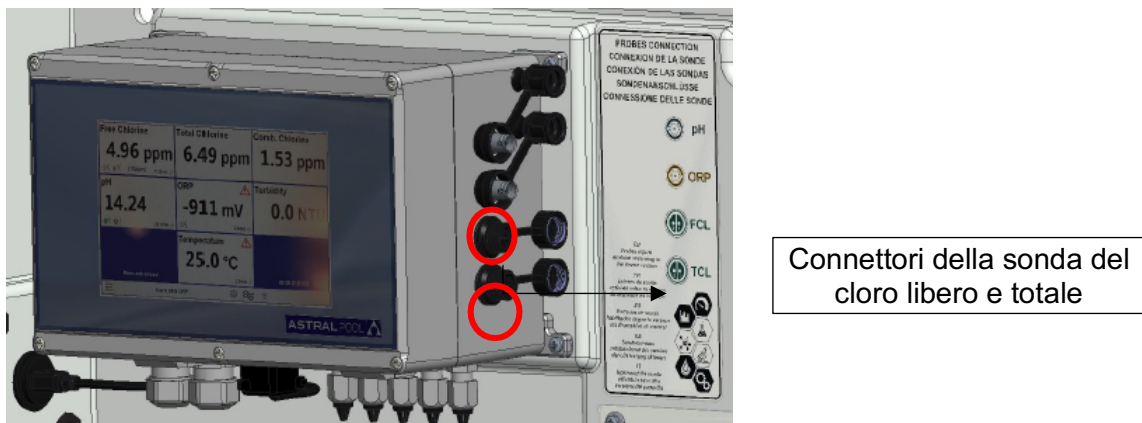

(Nota: controllare i collegamenti dell'etichetta con il collegamento di polarità delle sonde di cloro)

Figura 15 Connettori del cloro

4.6.4 COLLEGAMENTO SONDA TEMPERATURA

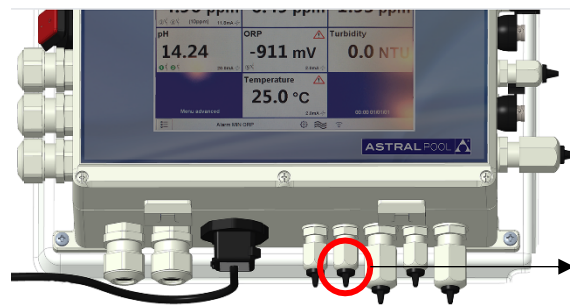

sonda temperatura collegata

Figur 16 Connettore temperatura

5 AVVIO E FUNZIONAMENTO

5.1 AVVIO

Accendere il sistema utilizzando l'interruttore di alimentazione posizionato sul lato superiore sinistro del dispositivo di controllo.



Figura 17 Interruttore di alimentazione

5.2 OPERAZIONE

- A: Collegare il tubo di ingresso
- B: Collegare il tubo di scarico
- C: Aprire completamente la regolazione del flusso
- D: Degassare il filtro dell'aria

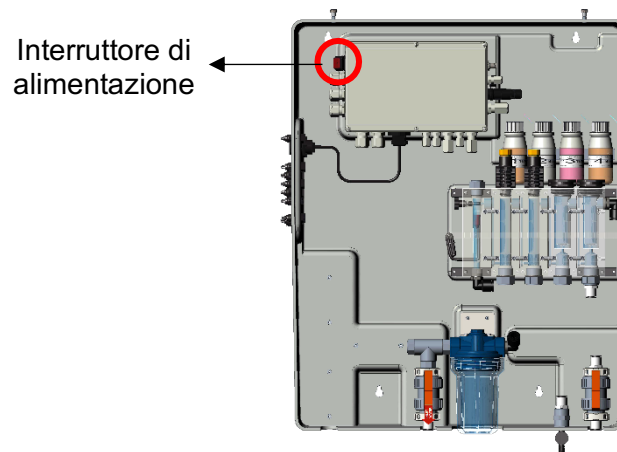
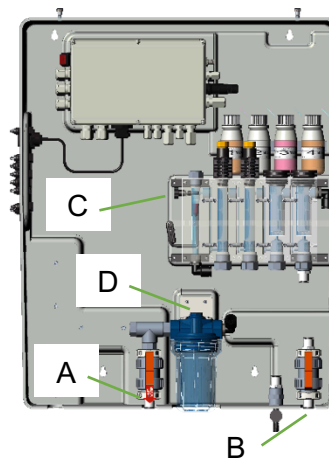

5.3 REGOLAZIONE DEL FLUSSO

La regolazione del flusso d'acqua deve essere eseguita tramite la valvola indicata nella figura riportata di seguito



Figura 18 Rubinetto portata

6 MANUTENZIONE

Per garantire sempre prestazioni ottimali dell'attrezzatura, è necessario sottoporla regolarmente a manutenzione. Consigliamo inoltre di seguire i nostri programmi di manutenzione.

Di seguito riportiamo un'indicazione degli intervalli massimi di manutenzione:

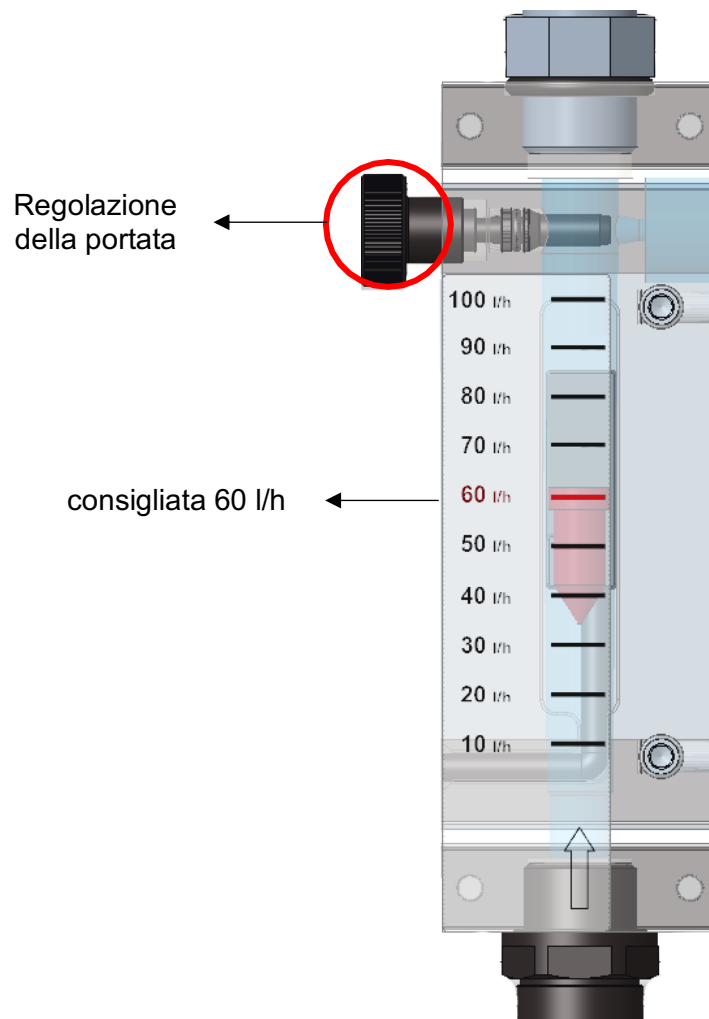
Operazione di manutenzione	INTERVALLI TEMPORALI			
	1 mese	2 mesi	3 mesi	6 mesi
Pulizia generale del sistema				X
Pulizia della rete del filtro dell'acqua	X			
Ispezione del circuito idraulico		X		
Pulizia della sonda	Secondo quanto riportato nel manuale d'istruzioni dell'elettrodo/della sonda.			

ATTENZIONE



Prima di eseguire qualsiasi operazione di manutenzione, spegnere l'apparecchiatura premendo l'interruttore elettrico generale della linea a cui è collegata.

ATTENZIONE



Prima di eseguire qualsiasi operazione di manutenzione, arrestare il flusso d'acqua che arriva all'apparecchiatura dall'impianto e depressurizzare aprendo completamente la valvola di prelievo campione.

6.1 PULIZIA GENERALE DEL SISTEMA

Eseguire questa operazione una volta al mese.

Pulire con regolarità tutte le superfici dell'apparecchiatura. Usare solo un panno umido senza aggiungere solventi o altri prodotti.

6.2 PULIZIA/SOSTITUZIONE DEL FILTRO DELL'ACQUA

Eseguire questa operazione ogni due mesi.

Attendere finché non esce più acqua dal circuito idraulico.

Svitare il vassoio dell'unità filtro e rimuovere la cartuccia del filtro dall'interno; fare attenzione a non perdere le guarnizioni.

Posizionare la cartuccia sotto l'acqua corrente e rimuovere tutti i detriti dal filtro utilizzando una spazzola morbida. Rimontare la cartuccia e il vassoio del filtro sull'impianto, facendo attenzione a riposizionare correttamente le guarnizioni.

Chiudere completamente la valvola di prelievo e ripristinare il flusso d'acqua nel circuito, aprendo gradualmente le valvole e rilasciando l'aria dall'impianto. Ricollegare il sistema all'alimentazione elettrica e verificare le condizioni di funzionamento dopo aver eseguito il test iniziale.

6.3 PULIZIA SONDA/ELETTRODO

Prima di eseguire questa operazione consultare il manuale d'istruzioni dell'elettrodo/della sonda.

Attendere finché non esce più acqua dal circuito idraulico. Scollegare i cavi degli elettrodi svitando i connettori alle loro estremità e le fascette di fissaggio, quindi rimuoverli dal porta sonda nel circuito idraulico del sistema. Lavare l'estremità sensibile con acqua tiepida e sapone neutro, rimuovendo eventuali residui di grasso utilizzando un pennello a setole morbide.

Per pulire le sonde non strofinarle con oggetti o panni abrasivi che possano caricarle elettrostaticamente.

In caso di sporco estremo, pulire gli elettrodi utilizzando alcool denaturato. Terminate le operazioni di pulizia, ricollegare gli elettrodi con i rispettivi cavi e calibrarli senza ripristinare l'afflusso di acqua al sistema. Al termine della procedura di calibrazione, scollegare il sistema dall'alimentazione elettrica e sostituire gli elettrodi nel portasonda. Ricollegare l'alimentazione e il flusso d'acqua al sistema dopo aver chiuso la valvola di prelievo campioni.

6.4 ISPEZIONE DEL CIRCUITO IDRAULICO

Eseguire questa operazione ogni sei mesi.

Ispezionare visivamente il circuito idraulico dell'attrezzatura dopo averlo scollegato dall'alimentazione elettrica. In presenza di perdite di liquido, danneggiamenti alle tubazioni o qualsiasi problema di tenuta, intervenire sul circuito idraulico solo dopo aver interrotto il flusso dell'acqua in arrivo alla stazione e depressurizzare l'impianto aprendo la valvola di prelievo campioni.

Sostituire le parti danneggiate solo con ricambi originali o consigliati.

ATTENZIONE



Non lasciare all'interno del circuito idraulico impurità che potrebbero otturarlo.

ATTENZIONE



Chiudere la valvola di prelievo campioni prima di ricollegare il flusso idrico al sistema. Ripristinare la pressione del sistema procedendo gradualmente, quindi alimentare elettricamente l'apparecchiatura.

7 INDIVIDUAZIONE E RISOLUZIONE DEI GUASTI

Guasti meccanici	
Il flusso all'interno della cella di misurazione è troppo basso	<ul style="list-style-type: none"> Controllare la guarnizione degli o-ring Controllare se il filtro è intasato Controllare la valvole di ingresso e scarico Controllare la valvola di prelievo campioni
Guasti elettrici	
Nessun segnale luminoso, display spento	Controllare che l'apparecchiatura sia alimentata correttamente (presa e spina). Se l'apparecchiatura resta inattiva contattare il nostro Centro assistenza
Misure errate	<ul style="list-style-type: none"> Controllare con cura la calibrazione, in caso di dubbio resettare lo strumento riportandolo alle impostazioni di fabbrica predefinite Verificare che le sonde funzionino correttamente e controllarne lo stato d'usura

Talvolta può fuoriuscire del liquido da un collegamento allentato o da una ghiera o semplicemente a seguito della rottura del tubo di alimentazione dell'acqua. Una volta eliminata la perdita, pulire e asciugare eventuali residui d'acqua nel sistema che stagnando potrebbero danneggiare le parti con cui vengono a contatto.

8 APPENDICE

ATTENZIONE



Questo TAB è protetto da password. Viene riportata nel presente manuale solo a scopo informativo.

APPENDICE 1 - FACTORY SETTINGS (IMPOSTAZIONI DI FABBRICA)



Figura 19 Impostazioni di fabbrica

8.1 PLUS VERSION (VERSIONE PLUS)

Consente di selezionare il tipo di versione che si vuole avere:

- PLUS 1 (Guardian NN 1): Cloro libero 10 ppm e Temperatura
- PLUS 2 (Guardian NN 2): Cloro libero 2 ppm e Temperatura
- PLUS 3 (Guardian NN 3): Cloro libero 10 ppm, pH e Temperatura
- PLUS 4 (Guardian NN 4): pH, Redox e Temperature
- PLUS 5 (Guardian NN 5): Cloro libero, pH, Redox e Temperatura
- PLUS 6 (Guardian NN 6): Cloro libero, pH, Redox, Cloro combinato, Torbidità e Temperatura
- PLUS 7 (Guardian NN 7): Cloro libero, pH, Torbidità e Temperatura

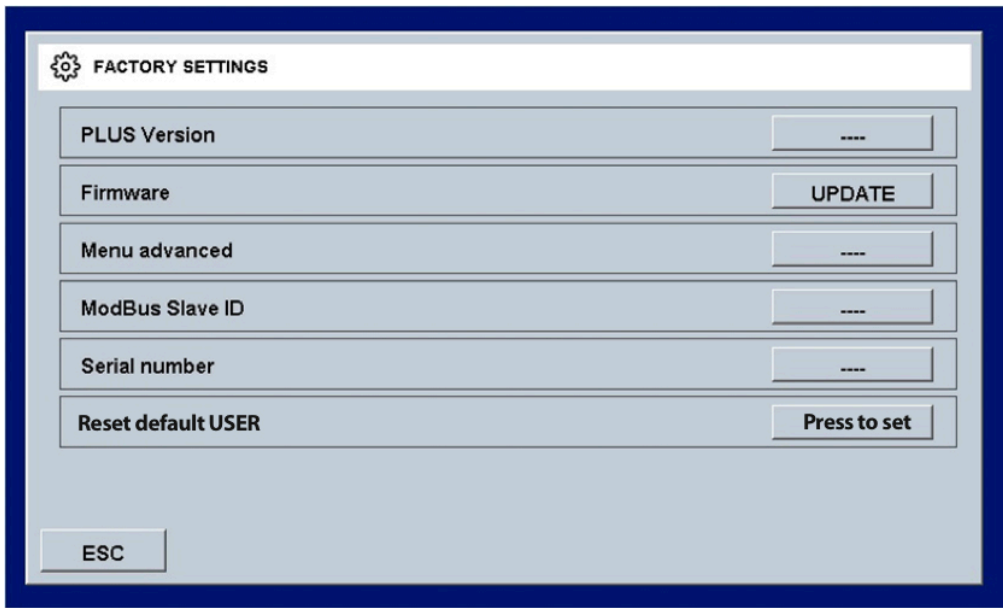
8.2 FIRMWARE

Permette di aggiornare il firmware: il file del firmware deve essere in una penna USB che deve essere inserita prima di premere OK sul tab "Press OK to Start" (Premere OK prima di avviare).



Figura 30 Aggiornamento del firmware

8.3 MENU ADVANCED (AVANZATO)

Consente di impostare la modalità avanzata, sbloccando alcuni menu nascosti in modalità standard (ON/OFF)

8.4 MODBUS SLAVE ID (ID SLAVE MODBUS)

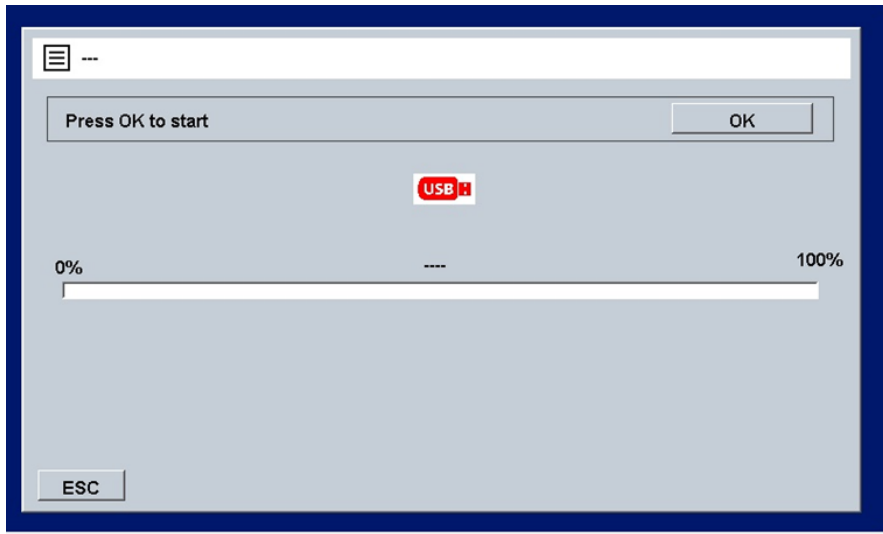
Consente di modificare l'ID slave, inserendone una nuova (ID=1 predefinita)

8.5 SERIAL NUMBER (NUMERO SERIALE)

Consente di modificare il numero seriale dello strumento

8.6 RESET DEFAULT USER (REINIZIALIZZA UTENTE PREDEFINITO)

Consente di azzerare tutti i parametri e ripristinare le impostazioni di fabbrica.

8.7 COLLEGAMENTO A FLUIDRA CONNECT

Connessione al quadro elettrico Connect & Go

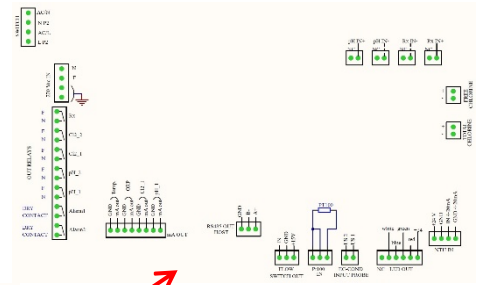
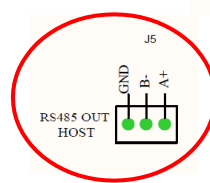
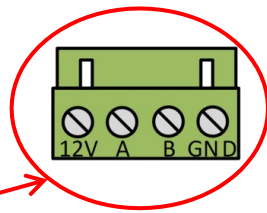

Connessione:

Connect & Go	12V	A	B	GND
Guardian Pool	Non usato	A+	B-	GND

Connessione a Connect Box

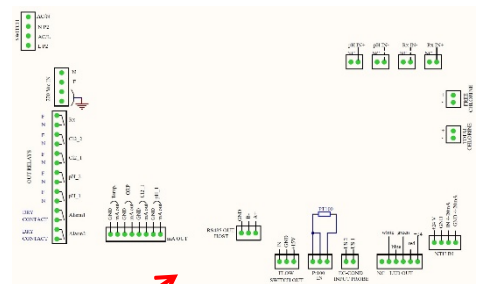
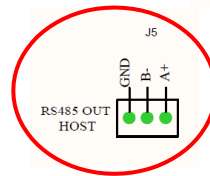
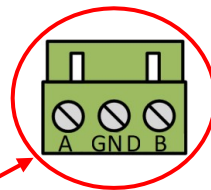
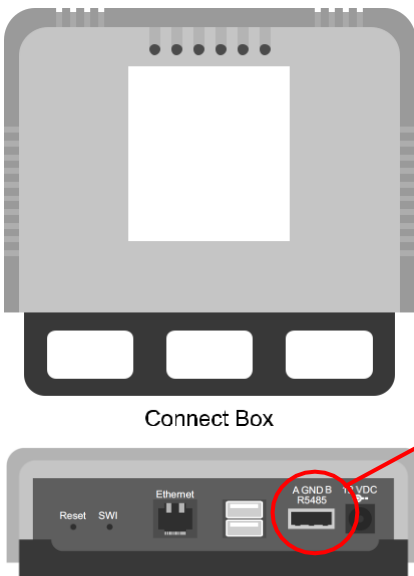

Connessione:

Connect Box	A	B	GND
Guardian Pool	A+	B-	GND

MULTIPARAMETRIC FLUIDRA

GUARDIAN Pool_NN SYSTEMS

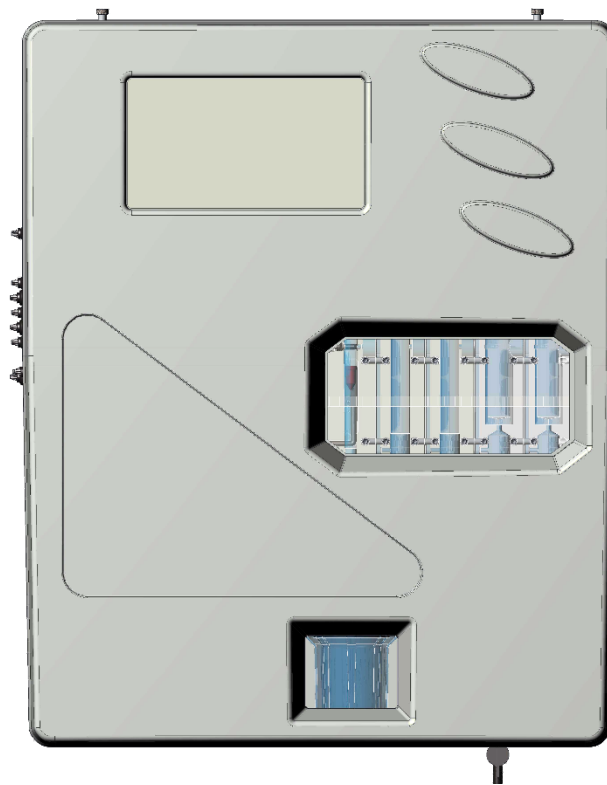

MANUAL DE UTILIZADOR

ÍNDICE

1	GERAL	4
1.1	LIMITES DE USO E PRECAUÇÕES PARA SEGURANÇA	4
1.1.1	SEGURANÇA ELÉTRICA	4
1.2	SÍMBOLO DE ATENÇÃO	4
1.2.1	ATENÇÃO ESPECIAL A COMPONENTES CRÍTICOS	4
1.2.2	SEGURANÇA DO AMBIENTE DE OPERAÇÃO	5
1.3	CARACTERÍSTICAS TÉCNICAS PRINCIPAIS	6
1.3.1	CARACTERÍSTICAS TÉCNICAS	7
2	DESCRIÇÃO GERAL	8
3	PROGRAMAÇÃO	9
3.1	PÁGINA PRINCIPAL	9
3.1.1	CONFIGURAÇÕES GERAIS	9
3.1.2	CONFIGURAÇÕES DE FÁBRICA	11
3.1.3	FLUXO	11
3.1.4	WI-FI	12
3.1.5	DATA E HORA	12
3.2	MEDIDAS	13
3.2.1	SET POINT [PONTO DE DEFINIÇÃO]	14
3.2.2	CALIBRAÇÃO	17
3.2.3	GRÁFICOS	18
3.2.4	ALARM VALUES [VALORES ALARME]	18
3.2.5	MEASURE NAME [NOME MEDIÇÃO]	18
3.2.6	FIRST CALIBRATION [PRIMEIRA CALIBRAÇÃO]	18
3.2.7	RANGE [LIMIAR]	18
4	INSTALAÇÃO	19
4.1	KIT DE INSTALAÇÃO	19
4.2	MONTAGEM NA PAREDE	20
4.3	CONEXÃO DA PLACA DE TERMINAIS	21
4.4	CONEXÕES ELÉTRICAS	24
4.5	CONEXÕES HIDRÁULICAS	24
4.6	CONEXÃO SONDAS	25
4.6.1	CONEXÃO DA Sonda DE pH E REDOX	25
4.6.2	CONEXÃO Sonda DE CONDUTIVIDADE	25
4.6.3	CONEXÃO Sonda DE CLORO	25
4.6.4	CONEXÃO Sonda DE TEMPERATURA	26
5	INICIALIZAÇÃO E OPERAÇÃO	26
5.1	INICIALIZAÇÃO	26
5.2	OPERAÇÃO	26
5.3	REGULAÇÃO DO FLUXO	27
6	MANUTENÇÃO	28
6.1	LIMPEZA GERAL DO SISTEMA	28
6.2	LIMPEZA/SUBSTITUIÇÃO DO FILTRO DE ÁGUA	28
6.3	LIMPEZA DO ELÉTRODO/SONDA	29
6.4	INSPEÇÃO DO CIRCUITO HIDRÁULICO	29
7	RESOLUÇÃO DE PROBLEMAS	30
8	APÊNDICE	31
8.1	Versão PLUS	31

8.2	FIRMWARE.....	32
8.3	MENU AVANÇADO.....	32
8.4	MODBUS SLAVE ID	32
8.5	NÚMERO DE SÉRIE	32
8.6	RESET UTILIZADOR PADRÃO	32
8.7	CONEXÃO A FLUIDRA CONNECT	33

1 GERAL

1.1 LIMITES DE USO E PRECAUÇÕES PARA SEGURANÇA

Para garantir a segurança do operador e o correto funcionamento do equipamento, é importante trabalhar dentro dos limites permitidos e adotar todas as precauções listadas em baixo:

ATENÇÃO



Verificar antes de usar para se certificar que todos os requisitos de segurança são totalmente satisfeitos. O equipamento não deve ser alimentado ou conectado a outro equipamento até que as condições de segurança estiverem satisfeitas.

1.1.1 SEGURANÇA ELÉTRICA

ATENÇÃO



Todas as conexões devem ser isoladas do solo (massa não isolada).
NÃO conectar qualquer destas conexões à terra.

Para garantir as condições de maior segurança para o operador, recomendamos que todas as indicações listadas neste manual sejam respeitadas.

- Alimentar o equipamento exclusivamente usando tensão de rede de acordo com as especificações (100 ÷ 240 Vac/dc 50-60 Hz)
- Substituir imediatamente as partes danificadas. Cabos, conectores, acessórios ou outras partes do equipamento que poderão estar danificados ou não funcionando corretamente devem ser substituídas imediatamente. Neste caso contactar o seu centro de assistência técnica autorizada mais próximo.
- De acordo com UL, não conectar às saídas de relé uma tensão superior a 115V

1.2 SÍMBOLO DE ATENÇÃO

O símbolo ilustrado em baixo representa o símbolo de **ATENÇÃO** e recorda ao operador que ele deve ler o manual de utilizador para as informações, recomendações e sugestões importantes para o uso correto e seguro do equipamento.

Este símbolo é também usado no software, em particular no ecrã “medidas”, prestando atenção a um evento que será explicado na página seguinte do ecrã.



Em particular, quando está posicionado junto dos pontos de conexão a cabos e periféricos, o símbolo em questão refere-se à leitura atenta do manual de utilizador para instruções relativas à natureza de tais cabos e periféricos e métodos de conexão correta e segura.

As reproduções de painéis de equipamento, com os relativos comandos, conexões, símbolos e etiquetas são fornecidas neste capítulo. Cada símbolo de cuidado é acompanhado por uma explicação detalhada do seu significado.

1.2.1 ATENÇÃO ESPECIAL A COMPONENTES CRÍTICOS

O instrumento está equipado com um ecrã de cristais líquidos LCD, que contém uma pequena quantidade de materiais tóxicos.

1.2.2 SEGURANÇA DO AMBIENTE DE OPERAÇÃO

O painel está protegido contra a introdução de líquidos. Evitar sujeitar o equipamento ao risco de gotas de água, jatos de água ou imersão em água e o uso em ambientes onde tais riscos poderão estar presentes. Equipamento no qual líquidos poderão acidentalmente ter penetrado deve ser imediatamente desligado, limpo e controlado por pessoal qualificado e autorizado.

Assim que a programação tiver sido realizada, recomendamos que o painel transparente seja fechado.

Proteção:

- com um painel transparente fechado IP65 EN60529
- com um painel transparente aberto IP54
- EMI /RFI CEI EN55011 - 05/99
- Uso do equipamento dentro dos limites ambientais de temperatura, humidade e pressão especificados.

O instrumento foi desenvolvido para operar nas seguintes condições ambientais:

- Temperatura do ambiente de trabalho: 0°C ÷ +50°C
- Temperatura de armazenamento e transporte: -10°C ÷ +50°C
- Humidade relativa: 10% ÷ 95%RH – sem condensação

ATENÇÃO



A estação de tratamento de água na qual o instrumento é inserido deve ser desenvolvida de acordo com os requisitos funcionais impostos pela legislação atual.

O aparelho deve ser inserido perfeitamente na estação.

A estação deve ser mantida operativa em total conformidade com as normas de segurança fornecidas.

Os parâmetros indicados na caixa de controlo do analisador devem estar em conformidade com as normas em vigor.

Quaisquer sinais de falhas do dispositivo devem estar posicionados em um ambiente que é constantemente controlado por pessoal operativo ou assistentes da estação.

A não conformidade com mesmo uma destas condições poderá fazer com que a “lógica” do dispositivo opere de um modo potencialmente perigoso para os utilizadores do sistema.

Portanto, recomendamos que o pessoal de assistência e/ou pessoal de manutenção opere com a maior atenção, comunicando imediatamente qualquer alteração nos parâmetros de segurança, para evitar a criação de situações potencialmente perigosas.

Porque as considerações indicadas em cima não podem ser controladas pelo produto em questão, o fabricante não pode ser considerado responsável por quaisquer danos que estes maus funcionamentos poderão causar a pessoas ou bens.

1.3 CARACTERÍSTICAS TÉCNICAS PRINCIPAIS

- Medição simultânea de: Livre de Cloro, pH, Redox e Temperatura (Opcional: Cloro Total, Cloro Combinado)
- **Programação:** usando o teclado com 4 teclas bolha
- LCD STN 240x128 retroiluminado
- Registador de Dados Interno Flash 4 Mbit armazenamento igual 16000 registos com possibilidade de visualizar em tabelas e gráficos a tendência de medição com a indicação dos valores mínimo, máximo e médio do período
 - **Intervalo de registo:** 00:00 ÷ 99:99 min
 - **Tipo:** circular / enchimento
 - **Visualização:** tabela/gráfico
- **P.I.D. Regulação para Saída pH**
- **Saída de Série RS485:** Protocolo MODBUS RTU com velocidade programável 1200 ÷ 38400 Baud Rate. para configuração, condição Tempo Real, ou download de dados
- 4 saídas analógicas:
 - **Quantidade:** ppm Cl₂, pH, Redox, Temperatura.
 - **Tipo:** 0.00 / 4.00 ÷ 20.00 mA galvanicamente isolado
 - **Programação limite:** inferior / superior / Inversão
 - **Carga máx:** 500 Ohm
- Saída de alarme de acordo com NAMUR 2.4 mA (com faixa 4/20mA)
- 2 Saídas de Relé de Alarme (falta de água de amostra, exaustão de reagentes, projetor queimado, célula suja)
- 2 Saídas Relé de Ponto Definição 2 para medição de Cloro
- 2 Saídas Relé de Ponto Definição 2 para medição de pH
- 1 Saída Relé de Ponto Definição 2 para medição de Redox
- 1 Saída Relé de Ponto Definição 2 para medição Temperatura (mas também Cloro Total ou Combinado a pedido)

Características de hardware principais do dispositivo

- A estrutura hardware deste periférico é baseada na adoção do extremamente novo CPU CMOS com 16 bits desenvolvido especificamente para a execução das denominadas aplicações “integradas”.
- A Placa usa um EEPROM para armazenar os dados de Configuração e memórias flash para armazenar os arquivos de dados históricos e ficheiros LOG de eventos.
- A Placa tem 1 porta RS485 (isolada opticamente) para redes locais usada para conexões com dispositivos de comunicação local (configuração computador, terminais e controlos remotos, etc).
- A placa integra um Relógio em Tempo Real (relógio com data) que permite ao software de armazenar números em uma ordem cronológica.

1.3.1 CARACTERÍSTICAS TÉCNICAS

Módulo de potência multiparâmetros para a determinação de:
Livre de Cloro, Cloro Total, pH, Redox, Temperatura e Turbidez

Parâmetro	Limiar	Resolução	Precisão
Livre de Cloro	00.00 ÷ 02.00ppm ou 10.00ppm Cl ₂	0.01ppm	1% f.s.
Cloro total	00.00 ÷ 10.00ppm Cl ₂	0.01ppm	1% f.s.
pH	00.00 ÷ 14.00 pH	0.01 pH	1% f.s.
Redox	±1000mV	1 mV	1% f.s.
Temperatura	00.0 ÷ 65.0 °C	0.1°C	1% f.s.
Ecrã gráfico	TFT 7" Toque resistivo retroiluminado. Visualização simultânea de valores de medição, condição de saídas digitais, condição de armazenamento, maus funcionamentos. Programação tátil		
Registador de Dados Interno	Flash 32 Mbit Intervalo de registo: 00:00 ÷ 99:99 min Tipo: circular / enchimento Visualização: tabela/gráfico		
4 Saídas Analógicas	ppm Cl ₂ , ppm Cl _{tot} , pH, Temperatura Tipo: 0.00 / 4.00 ÷ 20.00 mA galvanicamente isolado Programação limite: inferior / superior / Inversão Carga máx: 500 Ohm P.I.D. Regulação		
5 Saídas Relé de Ponto de Definição	Nº 2 para Cloro + Nº 2 para pH + 1 para Redox Ponto de definição com histerese: 00.00 ÷ 05.00 ppm Cl ₂ / 00.00 ÷ 14.00 pH / ± 1500 mV Programação de Histerese Carga resistiva máx relé 6A a 250Vac		
2 Saídas relé Alarme	ON-OFF cumulativo para: Mín/Máx, ponto de definição Carga resistiva máx relés 6A a 250Vac		
Entrada Digital	Para sensor de fluxo		
Saída de Série RS485	Protocolo MODBUS RTU com velocidade programável 1200 ÷ 38400 Baud Rate. para configuração, condição Tempo Real, ou download de dados		
Condições de operação	Temperatura Operacional: 0÷50°C Transporte e Armazenamento: -25÷65°C Humidade 10-95% não condensada		
Alimentação/ Proteção Elétrica	Alimentação: 90÷260Vac/dc 50-60Hz Absorção média: 30 W Proteção elétrica:		
Alojamento	Alojamento chapa individual ABS		

2 DESCRIÇÃO GERAL

A série de Painéis **Pool_NN** Guardian inclui os seguintes modelos:

Nº	Modelo	Código	Descrição
1	Guardian Pool_NN 1 Livre de Cloro 10 ppm	72700	Com sensor para cloro orgânico ⁽²⁾ 0-10 ppm Temperatura
2	Guardian Pool_NN 2 Água potável Livre de Cloro 2 ppm	72701	Com sensor para cloro orgânico ⁽²⁾ 0-2 ppm Temperatura
3	Guardian Pool_NN 3 pH e Livre de Cloro	- 72702	- pH - Livre de cloro orgânico ⁽²⁾ 0-10 ppm. Temperatura
4	Guardian Pool_NN 4 pH – ORP	- 72703	- pH - Sensor ORP, em eléctrodo de ouro (Sensorex) Temperatura
5	Guardian Pool_NN 5 pH – ORP – Sem Cloro	- 72704	- pH - Sensor ORP, em eléctrodo de ouro (Sensorex) - Livre de cloro orgânico ⁽²⁾ Temperatura
6	Guardian Pool_NN 6 pH, ORP, Livre de Cloro, Cloro Total, Cloro Combinado. Entrada para NTU (4- 20mA)	- 72705	- pH - Sensor ORP, em eléctrodo de ouro (Sensorex), - Livre de Cloro - Cloro Total - Sensor de turbidez Temperatura
7	Guardian Pool_NN 7 pH, Livre de Cloro, turbidez Entrada para NTU (4- 20mA)	- 74720	- pH - Sensor ORP, em eléctrodo de ouro (Sensorex), - Livre de Cloro - Cloro Total - Sensor de turbidez Temperatura

NOTAS:

(¹) Na versão ppm, com conversão para **Brometo** (fator de conversão 2.4) no equipamento atual, o cliente pode selecionar se ler Cloro ou Brometo.

(²) Este sensor pode ler **NaClO** (hipoclorito de sódio), **Ca(ClO)₂** (hipoclorito de cálcio), **Cl₂** (gás de cloro), cloro gerado eletroliticamente, e cloro combinado orgânico em base a ácido isocianúrico (testado até uma concentração de ácido isocianúrico de 500 mg/l).

3 PROGRAMAÇÃO

Este manual contém todas as informações para usar a página de instrumentos. Todas as janelas operativas serão analisadas, com fotografias e explicações.

3.1 PÁGINA PRINCIPAL



Figura 1 Página principal

3.1.1 CONFIGURAÇÕES GERAIS

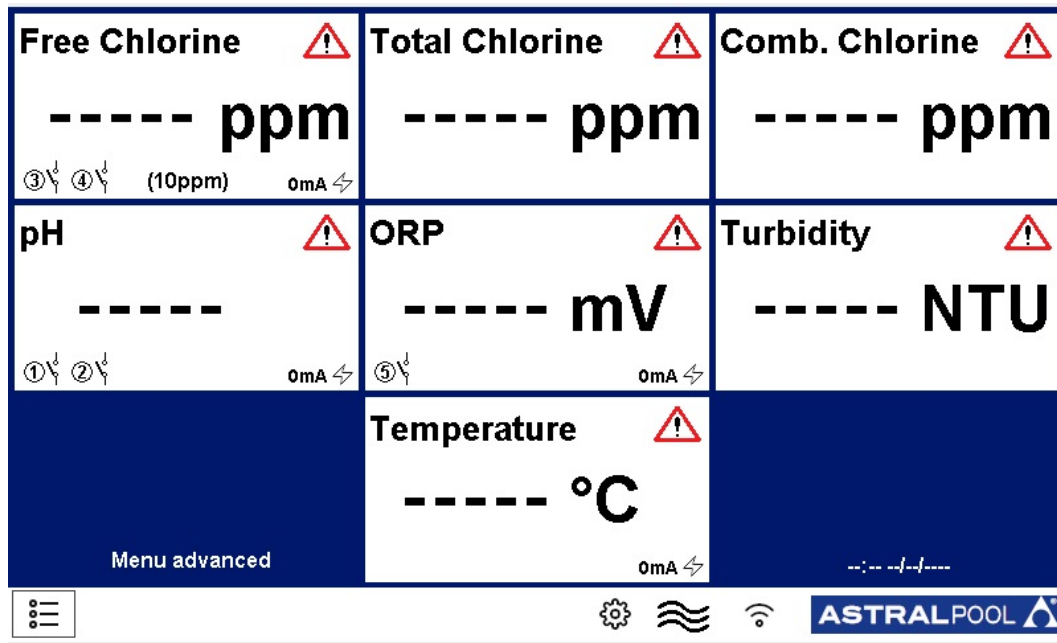

Figura 2 Configurações gerais

- **Arquivo:** como salvar os dados
 - **STEP [PASSO]:** Escolher a frequência de aquisição de dados por parte do sistema (minutos).
 - **TYPE [TIPO]:** Decidir o tipo de arquivo de dados:
 - **Circle [Círculo]:** Adquire os dados em modo FIFO.
 - **Finite [Finito]:** Adquire os dados até estar cheio. Depois necessita de ser esvaziado.
 - **Reset:** Faz reset aos dados salvados.
 - **Save on pen drive [Salvar na pen drive]:** O sistema salva os dados na porta USB.
 - **View record [Ver registo]:** Mostra os dados arquivados.
 - **Alarms Log [Registo de Alarmes]:** Mostra o histórico de alarmes.

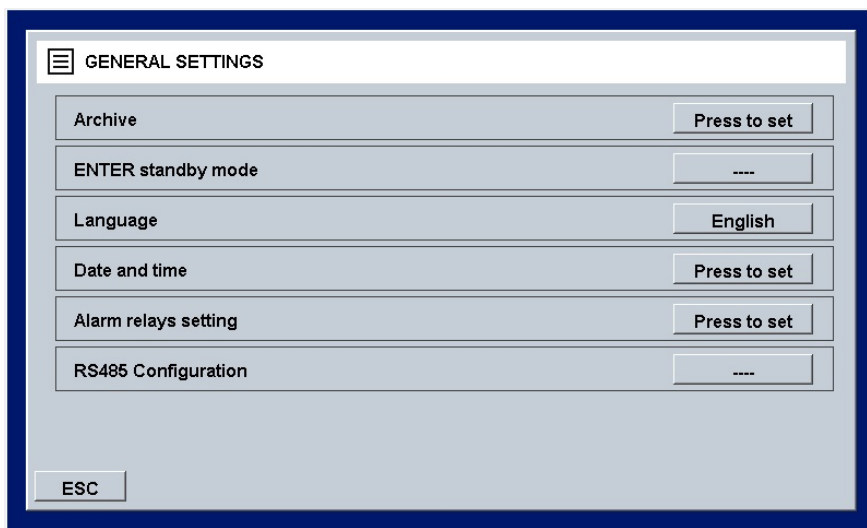

Figura 3 Configurações de arquivo

- **ENTER standby mode [ENTRAR em modo standby]**
O sistema entra em standby, o sistema mede mas não realiza dosagens ou comandos.
- **Language [Idioma]**
Configuração do idioma operativo (Inglês).
- **Date and time [Data e Hora]:**
Configuração da data e hora que são visualizadas na janela principal.

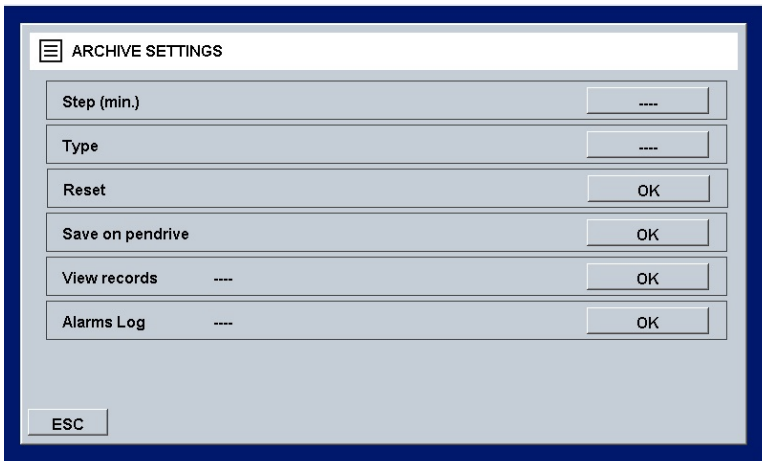

Figura 4 Data e hora

- **Configuração de relés de alarme**

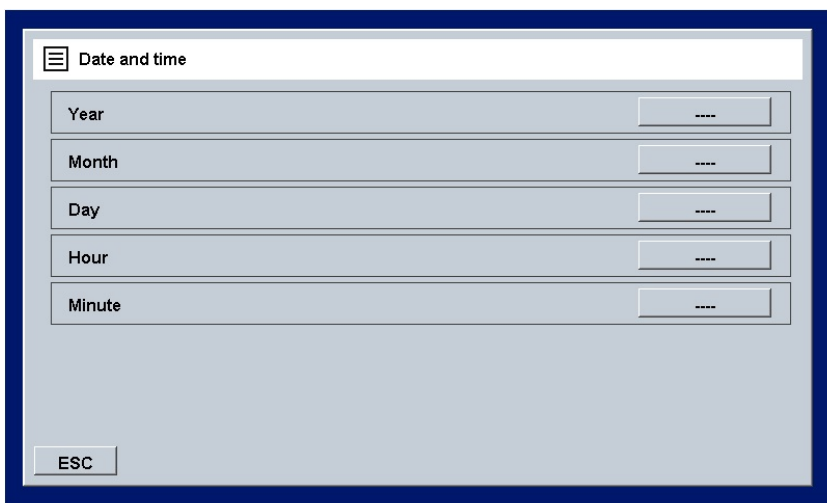

Figura 5 Data e hora

Existem dois relés de alarme e são atribuíveis:

- **ALARM RELAY ASSIGN [ATRIBUIR RELÉ DE ALARME]:** Escolher a medida na qual atribuir o relé; é possível escolher entre: todas as medidas, Combinar Cloro Setpoint ou Turbidity Setpoint
- **ALARM RELAY STATUS [ESTADO RELÉ DE ALARME]:** Permite escolher o estado normal do relé:
NO (Normal Aberto)
NC (Normal Fechado)
- **ALARM RELAY DELAY (SEC) [ATRASSO RELÉ ALARME (SEG)]:** Escolher o tempo (segundos) depois do qual o relé altera o seu estado.

3.1.2 CONFIGURAÇÕES DE FÁBRICA

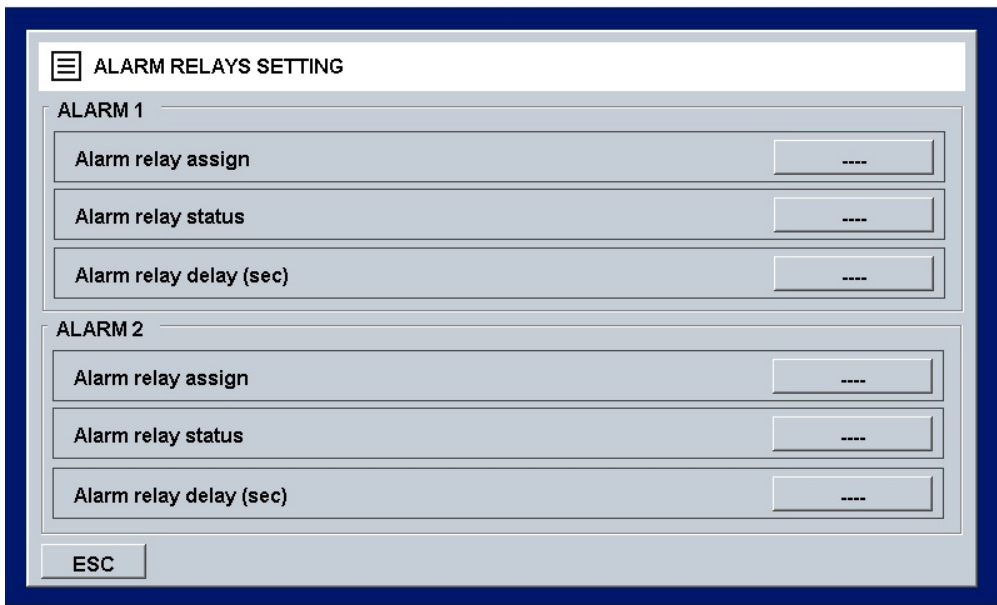

Esta janela está protegida por palavra-passe. A explicação é fornecida no apêndice.

3.1.3 FLUXO



Existem dois estados:



- ON: quando existe fluxo.



- OFF: quando não existe fluxo.

3.1.4 WI-FI

Este ícone mostra se existe uma conexão Wi-Fi LAN.

Para conectar à rede Wi-Fi LAN fazer do seguinte modo:

- 1) Conectar ao wi-fi SSID-XXXX com um telemóvel ou PC; a palavra-passe da rede é:
1234567890
- 2) Iniciar um navegador internet e conectar ao endereço: **192.168.4.1** e usar os seguintes dados para fazer o login:
 - Nome de utilizador: **admin**
 - Palavra-passe: **0000**
- 3) Quando conectado, certificar-se que no lado superior esquerdo do painel de instrumentos, junto de **Up since_ [Ligado desde_]** apareça a data e hora em que a placa foi ativada



Figura 6 Menu ponto de definição

3.1.5 DATA E HORA

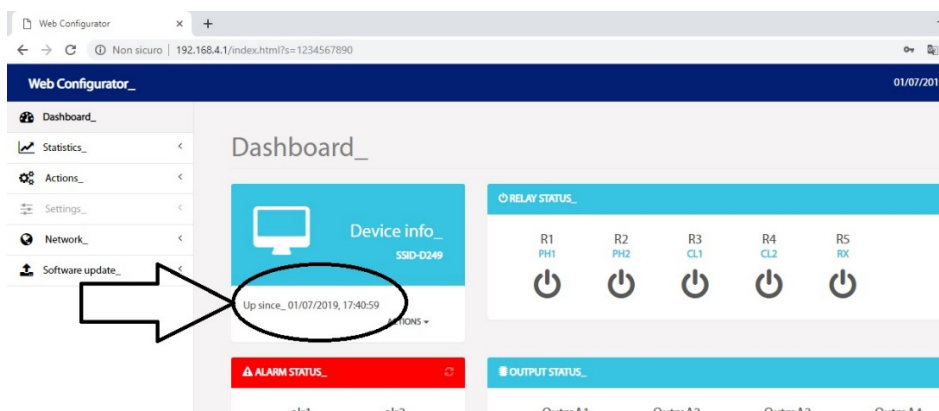

Mostra a data e hora que estão definidas na janela de menu

3.2 MEDIDAS



Figura 7 Janela principal

Quando se toca no separador da medição na janela principal, abre-se (Figura 7):

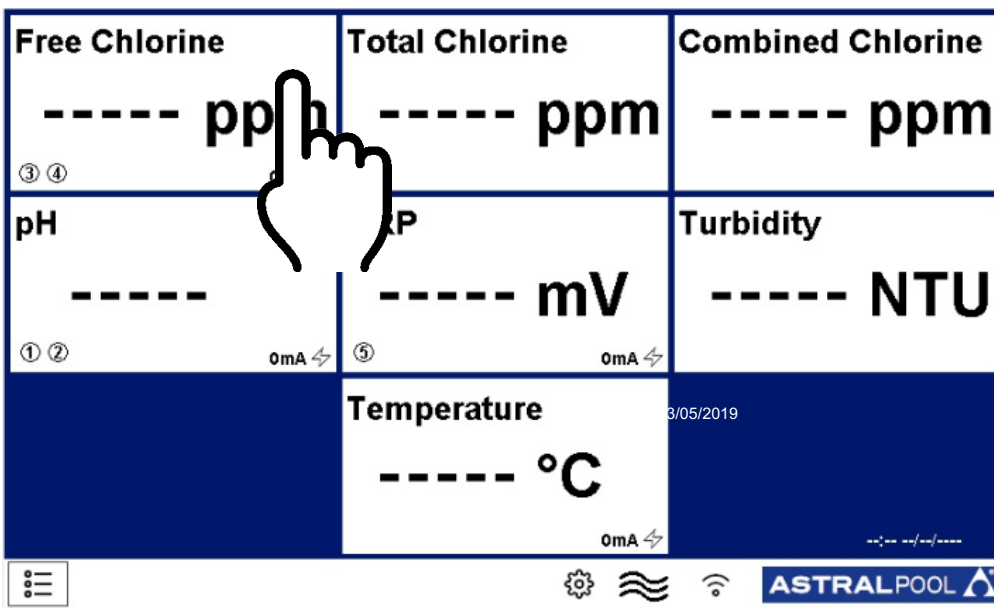
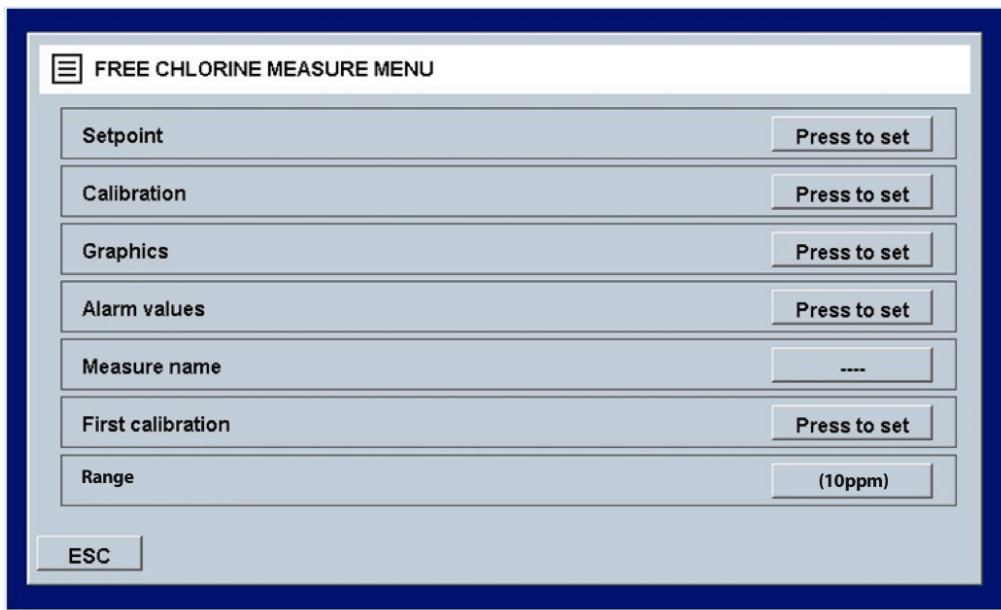
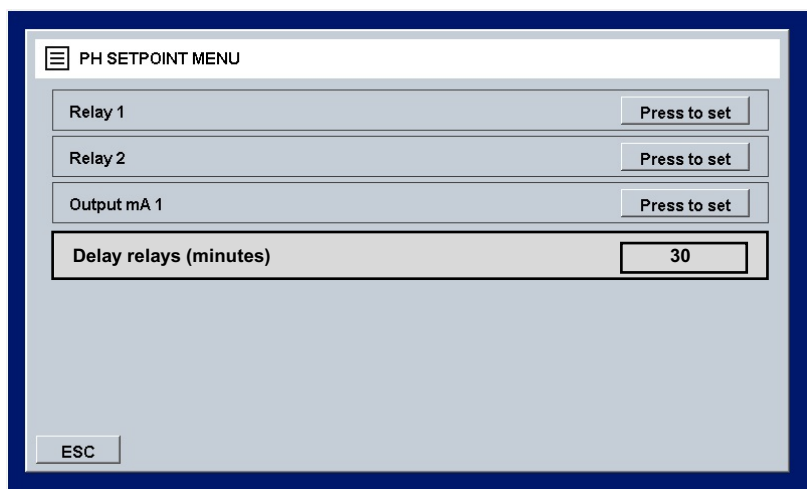

Figure 8 Menu medição

Esta janela é a mesma para todas as medições.

3.2.1 SET POINT [PONTO DE DEFINIÇÃO]:



Observação:

o menu “relés de retardo” afeta apenas os relés 3 e 4 do cloro livre, é ativado quando o instrumento é ligado, tem a função de aguardar o tempo de polarização da sonda de cloro livre, uma ampulheta é exibida na tela principal.



Figura 9 Menu de ponto de definição

- **Relés**

O número de relé utilizável é diferente para as medições:

- **Relé nº 1, 2 pH;**
- **Relé nº 3, 4 Sem Cloro;**
- **Relé nº 5 Rx;**



Figura 10 Menu de ponto de definição de relé

É a janela reservada ao relé:

SETPOINT [PONTO DE DEFINIÇÃO]: Definir o valor do ponto de definição em ppm

HYSTERESIS [HISTERESE]: Definir os limites em redor do ponto de definição (ponto de definição \pm histerese é a faixa)

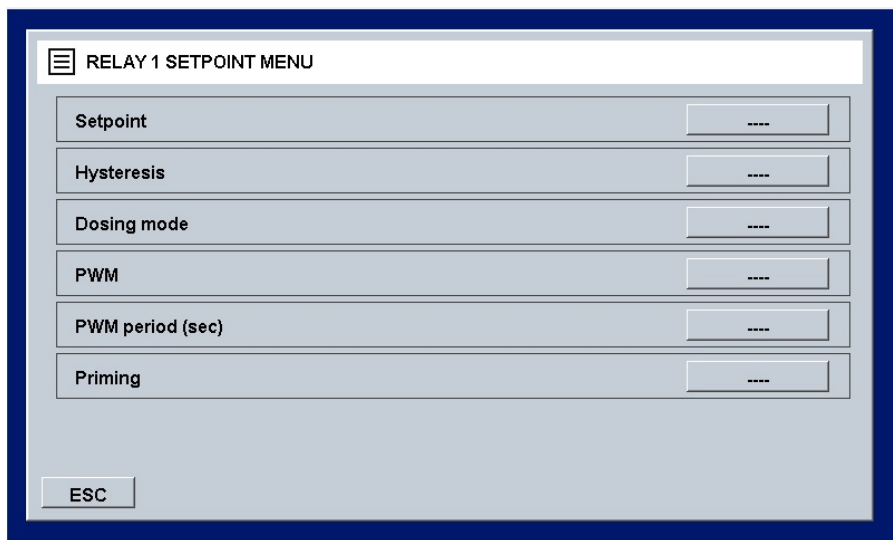
DOSING MODE [MODO DE DOSAGEM]: Set the Relay mode [Definir modo de Relé]:

- **HIGH [ALTO]:** O Relé fecha-se quando a medição é inferior ao ponto de definição \pm histerese, e abre-se quando a medição é superior ao ponto de definição \pm histerese

- LOW [BAIXO]: O Relé abre-se quando a medição é inferior ao ponto de definição \pm histerese, e fecha-se quando a medição é superior ao ponto de definição \pm histerese

Priming [Escorvamento]: É possível ativar manualmente as bombas de dosagem relativas aos produtos.

Exemplo ALTO/BAIXO:



Figura 1 Menu de ponto de definição de relé

É a escolha para aumentar o valor de medição quando desce abaixo de um valor definido.

O relé fecha-se se o valor de medição for inferior ao limite mínimo e abre-se quando regressa ao limite máximo.

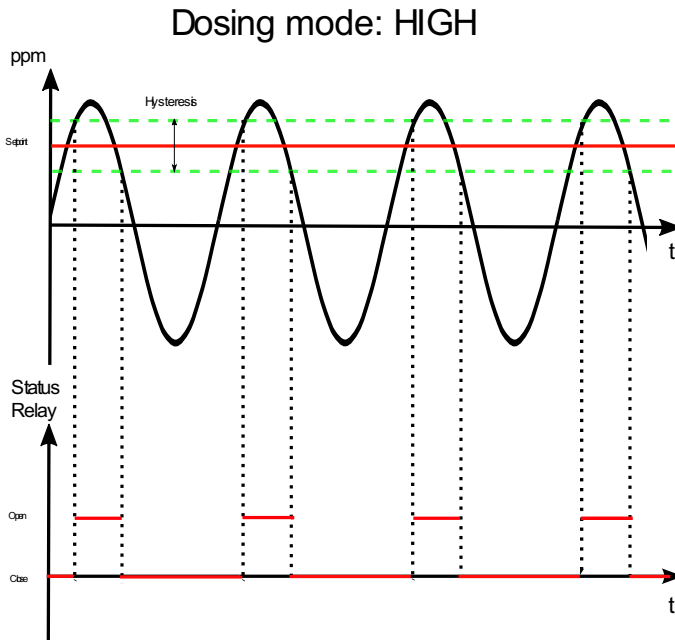

Figura 2 Menu de ponto de definição de relé

É a escolha para diminuir o valor de medição quando sobe acima de um valor definido.

O relé fecha-se quando o valor de medição for além do limite máximo e abre-se quando regressa ao limite mínimo.

- **SAÍDA mA**

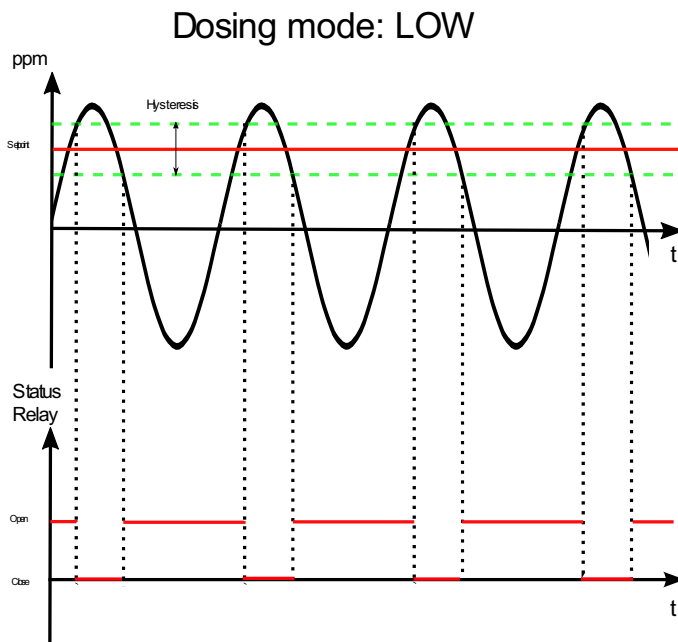
O número de saída mA utilizável é diferente para as medições:

- **Saída mA 1 pH;**
- **Saída mA 2 Livre de Cloro;**
- **Saída mA 3 Rx;**
- **Saída mA 4 Temperatura;**



Figura 53 Menu de configuração de saída

É a janela reservada para a saída mA:

LOW limit [Limite BAIXO]: Definir o valor mínimo da saída.

HIGH limit [Limite ALTO]: Definir o valor máximo da saída.

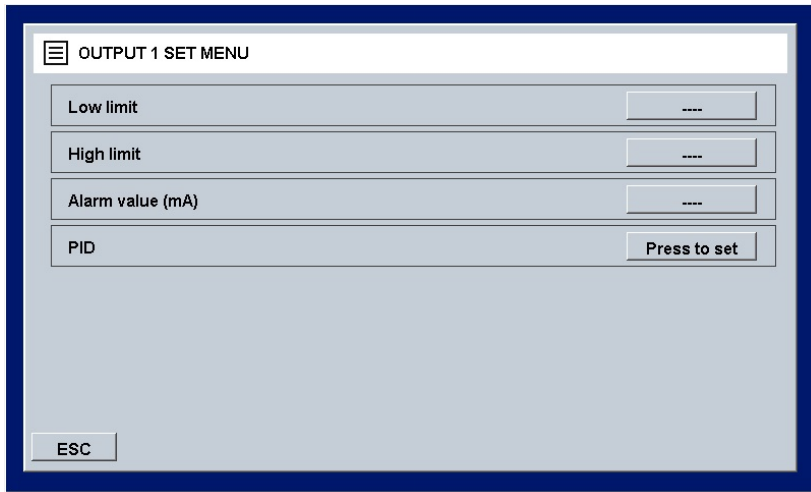
Alarm value (mA) [Valor alarme (mA)]: Definir o valor que, se for ultrapassado, irá gerar um alarme.

PID: Pressionar para abrir a janela do PID



Figura 14 Menu de configuração PID

PID: PID habilitado na saída (ON/OFF).

PID Set point [Ponto de definição PID]: Define o ponto de definição do PID.

PID algorithm [Algoritmo PID]: Define o tipo de PID (P/I/D).

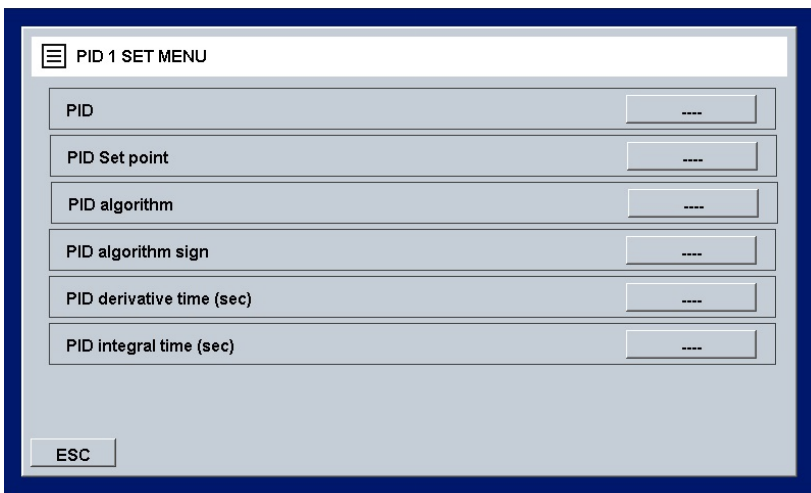
PID algorithm sign [Sinal de algoritmo PID]: Define o tipo de controlo (Direto/Inverso).

- **Valor Máx Lógico / Valor Mín Lógico**

Se a histerese não estiver presente, podem ser definidos os limites superior e inferior; se a medição excede estes valores é gerado um alarme.

3.2.2 CALIBRAÇÃO



Figura 15 Calibração

Este separador mostra o método de calibração para medições; seguir as instruções no ecrã: Inserir a sonda no tampão, esperar que a medição se estabilize (nas áreas no círculo) e depois pressionar OK. Abre a seguinte janela:

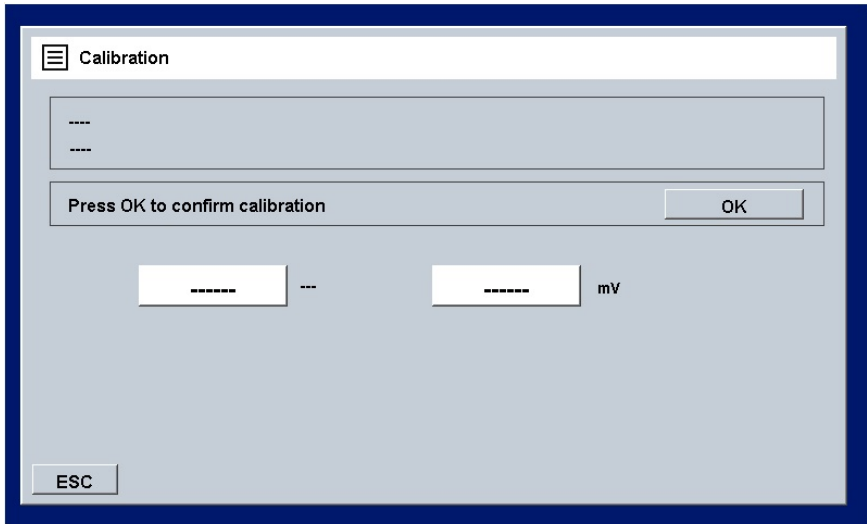

Figura 66 Definir valor

Definir o valor do tampão e pressionar OK.

Apenas o pH necessita de calibração de 2 pontos (com soluções tampão de 4 pH e 7 pH): Quando se pressionar "Calibrate" [Calibrar], abre a janela das outras calibrações.

3.2.3 GRÁFICOS

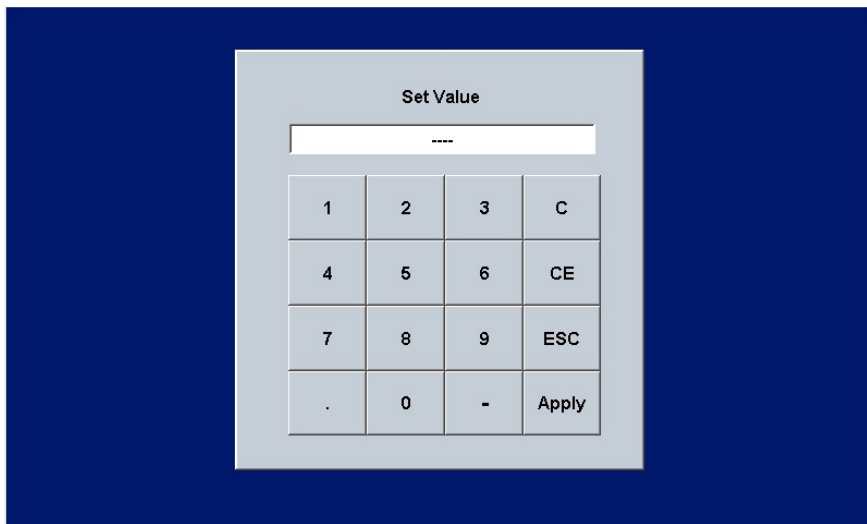

Figura 7 Menu gráficos

- **Min value on diagram [Valor mín no diagrama]:** Define o valor mín no gráfico
- **Max value on diagram [Valor máx no diagrama]:** Define o valor máx no gráfico
- **Graph time setting [Configuração tempo gráfico]:** Define os eixos de tempo
- **Graphics [Gráficos]:** Pressionar para visualizar o gráfico (figura 18)

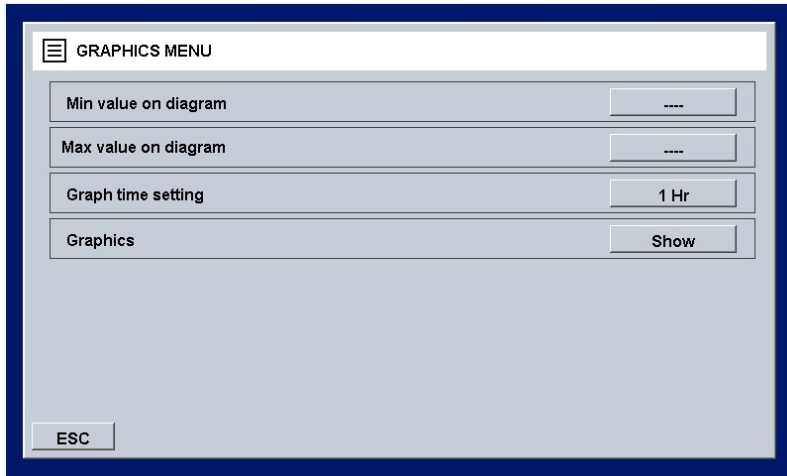

Figura 8 Gráfico

3.2.4 ALARM VALUES [VALORES ALARME]

Define o valor mín/máx acima/abaixo que ativa o alarme

3.2.5 MEASURE NAME [NOME MEDIÇÃO]

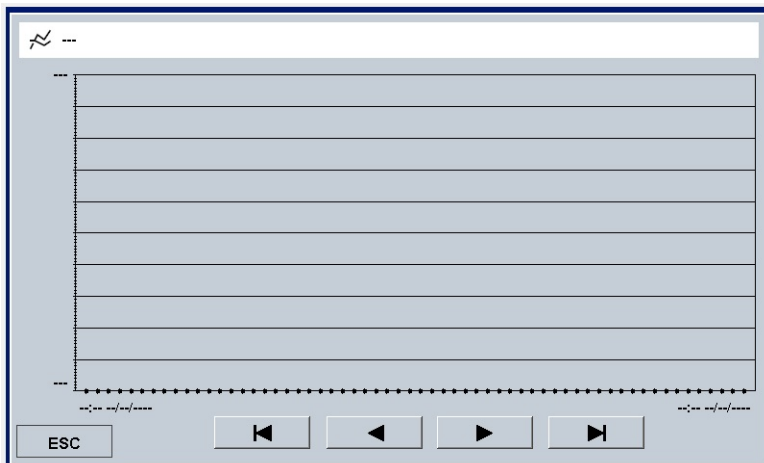
Permite modificar o nome da medição no separador

3.2.6 FIRST CALIBRATION [PRIMEIRA CALIBRAÇÃO]

Realizar a primeira calibração apenas depois de esperar 90 minutos

3.2.7 RANGE [LIMIAR]

Define os limiares de medição de operação da sonda.

4 INSTALAÇÃO

Antes de instalar o **multi-parâmetros AstralPOOL**, ler o seguinte atentamente. Esta secção descreve os passos para a instalação do equipamento e ligação elétrica. Seguir estas indicações durante a instalação.

- Certificar-se que o equipamento e todos os dispositivos relacionados estejam desligados antes de iniciar os trabalhos.
- Se se encontrarem anomalias ou sinais de aviso, parar imediatamente. Retomar o trabalho apenas depois de se ter removido a causa do problema.
- Não instalar o equipamento em locais perigosos ou em áreas com risco de incêndio ou explosão.
- Evitar riscos elétricos. Nunca usar equipamento danificado ou defeituoso.

4.1 KIT DE INSTALAÇÃO

	 1: Parafusos de fixação (φ=6 mm parafusos)	 2: 8x12 Tubo cristal PVC (4 m)	 3: Alojamento da sonda	 4: Conectores	
	 5: 2 ppm Sonda de Livre de Cloro	 6: 10 ppm Sonda de Livre de Cloro	 7: 10 ppm Sonda de Cloro Total	 8: Cabo para sonda de cloro (1m)	
	 9: sonda pH	 10: Sonda Redox	 11: Soluções tampão pH	 12: Solução tampão ORP	
 13: Cartucho Filtro	 14: Sistema de contralavagem	 15: PSS8 Alojamento de sonda de turbidez	 16: Sonda de turbidez	 17: Sensor de temperatura	 18: Sonda de condutividade e cabo

N	Item	Pool_NN 1	Pool_NN 2	Pool_NN 3	Pool_NN 4	Pool_NN 5	Pool_NN 6	Pool_NN 7
	Codigo	72700	72701	72702	72703	72704	72705	74720
1	Parafusos de fixação	•	•	•	•	•	•	•
2	8x12 Tubo PVC 4 metros	•	•	•	•	•	•	•
3	Alojamento da sonda	•	•	•	•	•	•	•
4	Conectores	•	•	•	•	•	•	•
5	2 ppm Sonda de Livre de Cloro		•					
6	10 ppm Sonda de Livre de Cloro	•		•		•	•	•
7	10 ppm Sonda de Cloro Total						•	
8	Cloro Cabo 1 metro	•(x1)	•(x1)	•(x1)		•(x1)	•(x2)	•(x1)
9	Sonda pH			•	•	•	•	•
10	Sonda Redox				•	•	•	
11	Solução tampão pH7 e 4pH			•	•	•	•	•
12	Solução tampão 465 mV Redox				•	•	•	
13	Filtro cartucho 80µm	•	•	•	•	•	•	•
14	Sistema de contralavagem	(*1)	(*1)	(*1)	(*1)	(*1)	(*1)	(*1)
15	PSS8 Alojamento de Sonda de Turbidez						•	
16	Sonda de Turbidez						•	
17	Sonda Temperatura	•	•	•	•	•	•	•
18	Sonda de Condutividade e Cabo	(*1)	(*1)	(*1)	(*1)	(*1)	(*1)	(*1)

(*1 a pedido).

4.2 MONTAGEM NA PAREDE

Instalar a unidade de controlo afastada das fontes de calor, em um local seco, sem salpicos de água e protegida da queda de gotas, a temperaturas inferiores a 40°C. A temperatura mínima não deve descer abaixo de 0°C.

A unidade de controlo deve ser instalada certificando-se de deixar espaço suficiente para os cabos e conexões.

O painel traseiro da unidade de controlo é dotado de 4 furos junto dos cantos para a montagem da unidade na parede. A figura em baixo indica a posição dos furos de perfuração e as dimensões máximas do painel.



Figura 9 Montagem do sistema na parede

Se adequado para o suporte, usar os tampões de parede fornecidos, se não escolher um tipo adequado. A unidade é fornecida já montada e ligada internamente.

Para assegurar um suporte ideal do sistema a parede deve ser o mais reta e nivelada possível.

Fazer dois furos alinhados horizontalmente a uma altura que permita ao operador de ter uma vista correta do painel de controlo e uma posição adequada para as operações de calibração e controlo.

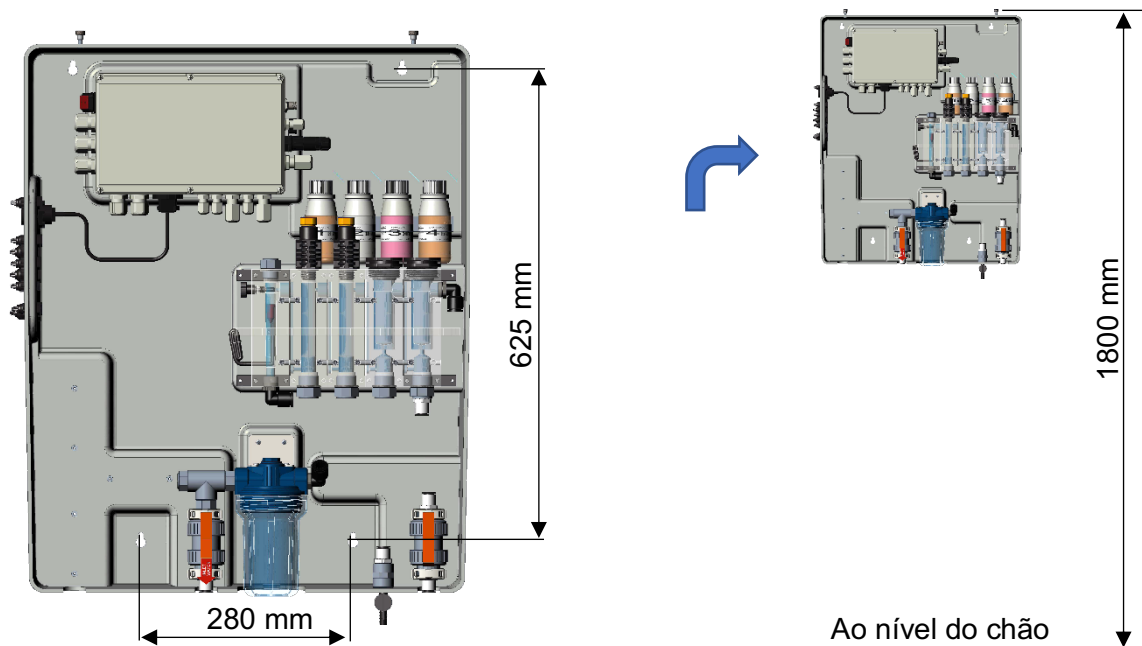
A altura recomendada do chão é de cerca 180 cm ou, pelo menos, ao nível dos olhos.

A distância entre os furos é indicada na fotografia acima.

Usar um nível de bolha durante a instalação para nivelar corretamente a unidade de controlo.

As dimensões totais do invólucro são: 730x600x230 mm (A x C x P)



Figura 10 Dimensões do sistema

4.3 CONEXÃO DA PLACA DE TERMINAIS

Antes de instalar o multi-parâmetros Astralpool, ler o seguinte atentamente



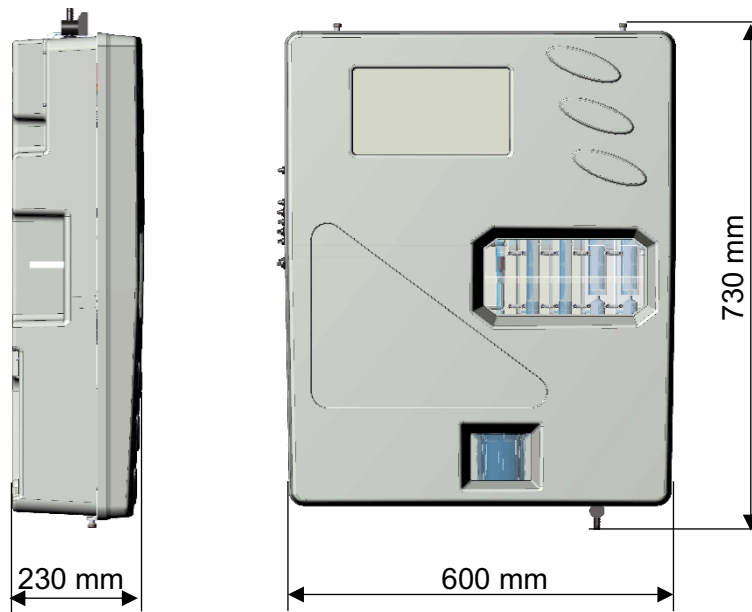







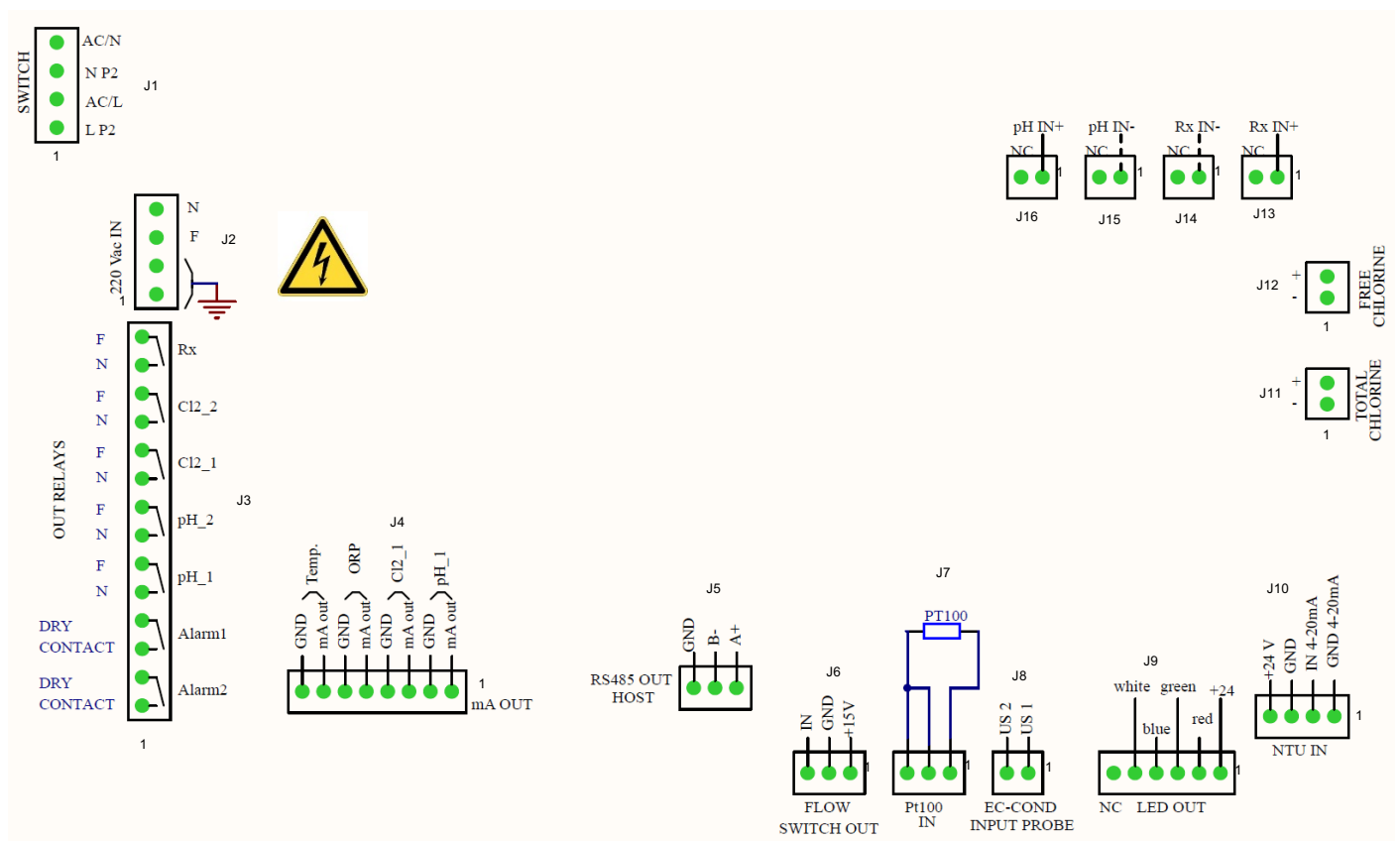
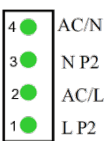
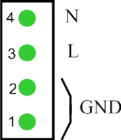









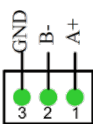
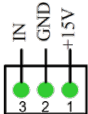

Figura 11 Conexões

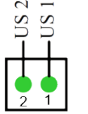
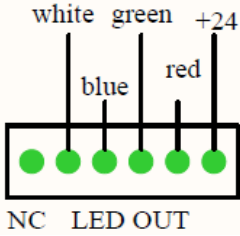
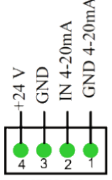
Conector	Terminal	FOTOGRAFIA	DESCRIÇÃO	
J1	1		Cabo neutro alimentação corrente alternada	
	2		Cabo neutro 220 Vac	
	3		Cabo linha alimentação corrente alternada	
	4		Cabo de linha 220 Vac	
J2	1		Cabo de terra 1	
	2		Cabo de terra 2	
	3		Cabo linha alimentação 220 Vac	
	4		Cabo neutro alimentação 220 Vac	
J3	1	ALARME 2 	Relé alarme (2) remoto	contacto seco
	2		Relé alarme (2) remoto	
	3	ALARME 1 	Relé alarme (1) remoto	contacto seco
	4		Relé alarme (1) remoto	
	5	pH_1 	Ponto definição pH 1	contacto alimentado (100-240Vac)
	6		Ponto definição pH 1	
	7	pH_2 	Ponto definição pH 2	contacto alimentado (100-240Vac)
	8		Ponto definição pH 2	
	9	Cl2_1 	Ponto definição Cl ₂ 1	contacto alimentado (100-240Vac)
	10		Ponto definição Cl ₂ 1	
	11	Cl2_2 	Ponto definição Cl ₂ 2	contacto alimentado (100-240Vac)
	12		Ponto definição Cl ₂ 2	
	13	Rx 	Ponto definição Rx	contacto alimentado (100-240Vac)
	14		Ponto definição Rx	
J4	1	pH_1 	cabo positivo mA pH	
	2		cabo negativo mA pH	
	3	Cl2_1 	cabo positivo mA Cl ₂ (1)	
	4		cabo negativo mA Cl ₂ (1)	
	5	ORP 	cabo positivo mA ORP	
	6		cabo negativo mA ORP	
	7	Temp 	cabo positivo mA Temperatura	
	8		cabo negativo mA Temperatura	
J5	1		Interface RS485 (A+)	
	2		Interface RS485 (B-)	
	3		Interface RS485 (Terra)	

(* 1 O relé de alarme é configurável em: Medição de alarme total, Ponto de ajuste CL Comb; Ponto de ajuste de turbidez)

Conector	Terminal	FOTOGRAFIA	DESCRIÇÃO	
J6	1		Cabo +15 V	
	2		Cabo de terra	
	3		Cabo Entrada	
J7	1		Cabo conexão PT 100	
	2		Cabo conexão PT 100	
	3		Cabo conexão PT 100	
J8	1		Sonda EC-Cond	Cabo μ S 1
	2			Cabo μ S 2
J9	1		+24V	
	2		Vermelho	
	3		Verde	
	4		Azul	
	5		Branco	
	6		NC	
J10	1		Sonda de turbidez	4-20 mA (Terra)
	2			4-20 mA (IN)
	3			Alimentação 24 V-
	4			Alimentação 24 V+
J11	1		Sonda Cloro Total	cabo negativo Cl_{tot}
	2			cabo positivo Cl_{tot}
J12	1		Sonda de Livre de Cloro	Cabo negativo Cl_2
	2			Cabo positivo Cl_2
J13	1		Sonda ORP	RG 174 Rx (IN +)
	2			RG 174 Rx (IN -)
J14	1		Sonda pH	RG 174 pH (IN -)
	2			RG 174 pH (IN +)
J15	1		Sonda pH	RG 174 pH (IN -)
	2			RG 174 pH (IN +)
J16	1		Sonda pH	RG 174 pH (IN -)
	2			RG 174 pH (IN +)

4.4 CONEXÕES ELÉTRICAS

Conexão da placa de terminais:

N	Item	Function	Codigo	Pool_N	Pool_NN	Pool_NN	Pool_NN	Pool_NN	Pool_NN	Pool_NN
				N 1	2	3	4	5	6	7
				72700	72701	72702	72703	72704	72705	74720
1	100-240Vac 50-60Hz	Power Supply		•	•	•	•	•	•	•
2	Relay1 (pH1)	Dose action powered				•	•	•	•	•
3	Relay2 (pH2)	Dose action powered				•	•	•	•	•
4	Relay3 (CL1)	Dose action powered		•	•	•		•	•	•
5	Relay4 (CL2)	Dose action powered		•	•	•		•	•	•
6	Relay5 (Rx)	Dose action powered					•	•	•	
7	Relay6 (Alr1)	Alarm Status dry contact		•	•	•	•	•	•	•
8	Relay7 (Alr2)	Alarm Status dry contact		•	•	•	•	•	•	•
9	mA1 (pH)	Output mA				•	•	•	•	•
10	mA2 (Cl)	Output mA		•	•	•		•	•	•
11	mA3 (Rx)	Output mA					•	•	•	
12	mA4 (°C)	Output mA		•	•	•	•	•	•	•
13	RS485 Serial port	Communication		•	•	•	•	•	•	•
14	Reed Input	Flow status input		•	•	•	•	•	•	•
15	pH probe	Input mV signal				•	•	•	•	•
16	CL probe1	Input mA signal		•	•	•		•	•	•
17	CL probe2	Input mA signal							•	
18	Turbidity probe	Input mA signal							•	•
19	Rx probe	Input mV signal					•	•	•	
20	Temp. probe	Input Ohm signal		•	•	•	•	•	•	•
21	5 VDC output	Power supply for Led light		•	•	•	•	•	•	•
22	Wi-Fi Connection	Wi-Fi Connection		•	•	•	•	•	•	•
23	Conductivity Probe	Input mV signal		•	•	•	•	•	•	•

4.5 CONEXÕES HIDRÁULICAS



Figura 12 Conexões hidráulicas

4.6 CONEXÃO SONDAS

4.6.1 CONEXÃO DA SONDA DE pH E REDOX

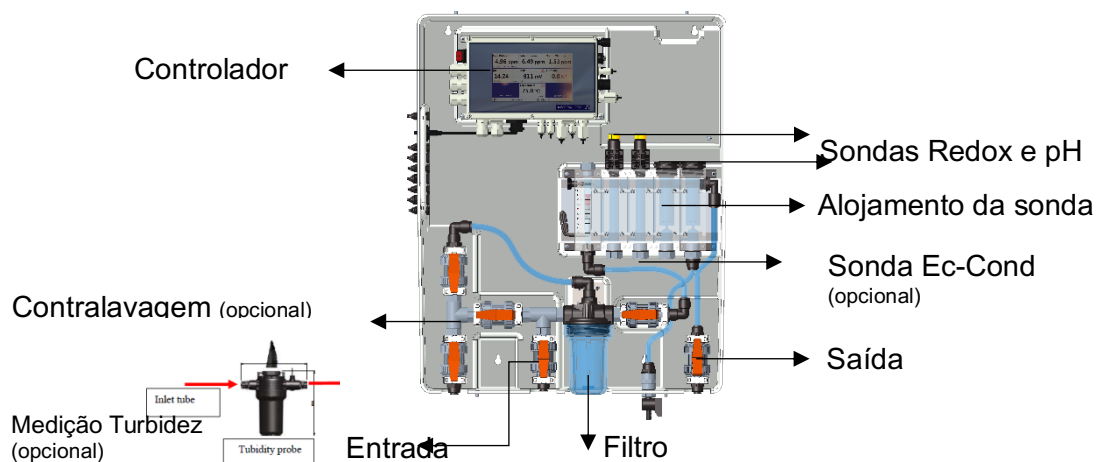

Figura 13 Conectores pH e Redox

4.6.2 CONEXÃO SONDA DE CONDUTIVIDADE

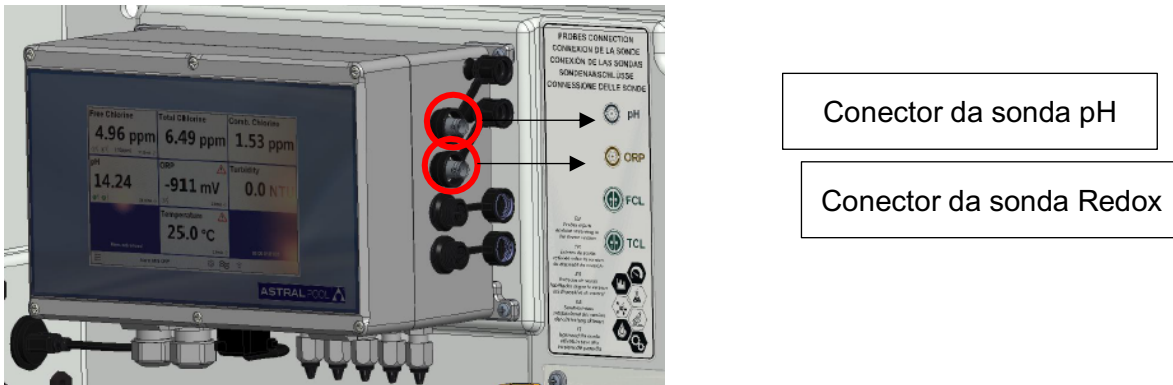

Figura 14 Conector condutividade

4.6.3 CONEXÃO SONDA DE CLORO

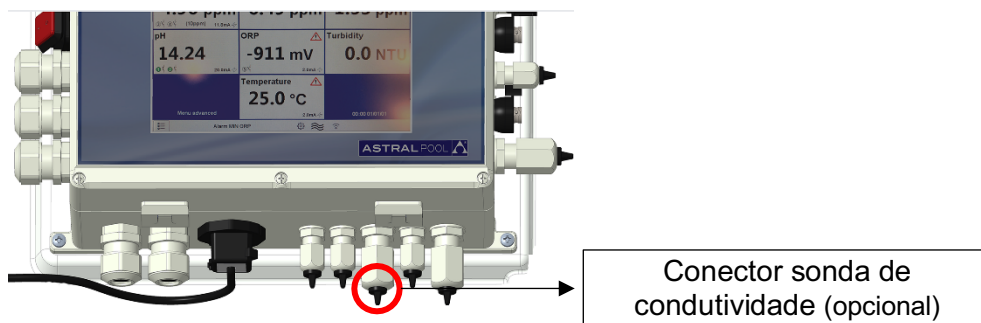
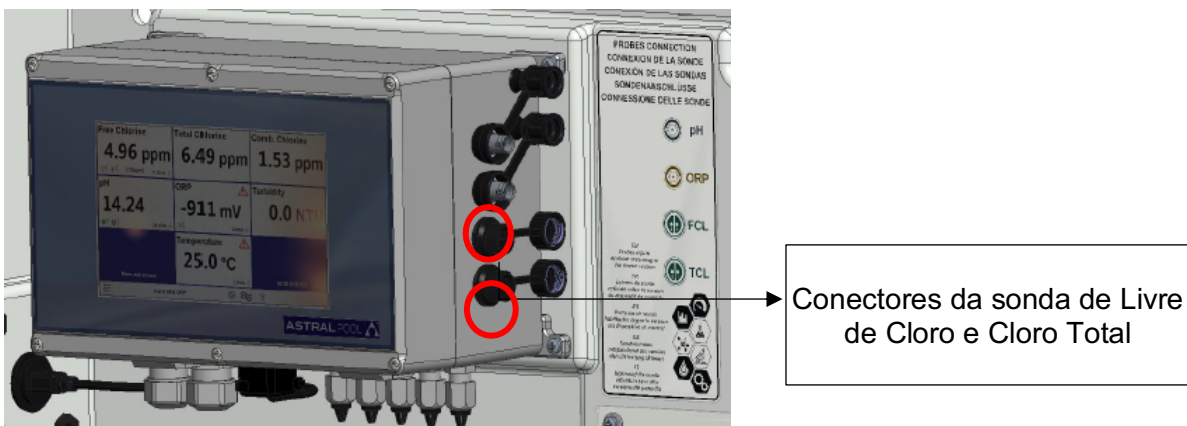

(Nota: por favor, verifique las conexiones de la etiqueta con la conexión de polaridad de las sondas de cloro)

Figura 15 Conectores de cloro

4.6.4 CONEXÃO SONDA DE TEMPERATURA



Figura 16 Conector temperatura

5 INICIALIZAÇÃO E OPERAÇÃO

5.1 INICIALIZAÇÃO

Acender o sistema usando o Interruptor de Acendimento no lado esquerdo superior no controlador.

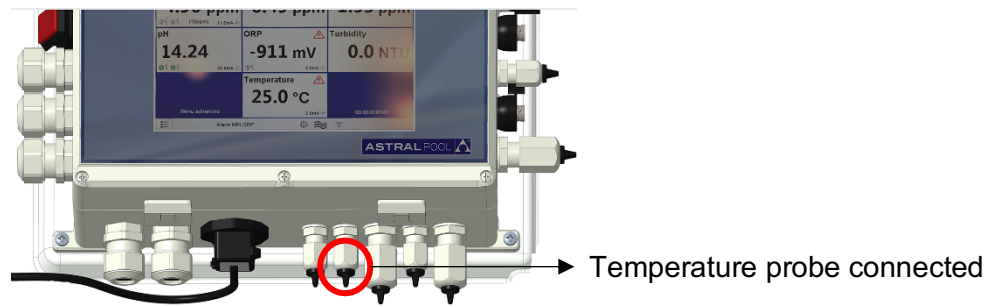

Figura 17 Interruptor de acendimento

5.2 OPERAÇÃO

- A: Conectar Tubo de entrada
- B: Conectar Tubo de saída
- C: Abrir completamente a regulação de fluxo
- D: Desgaseificação do filtro de ar

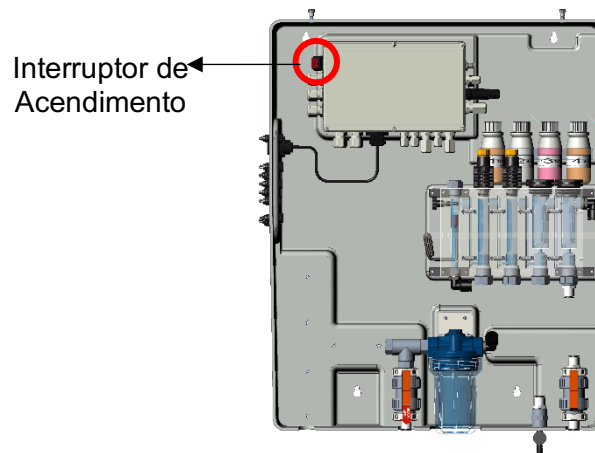
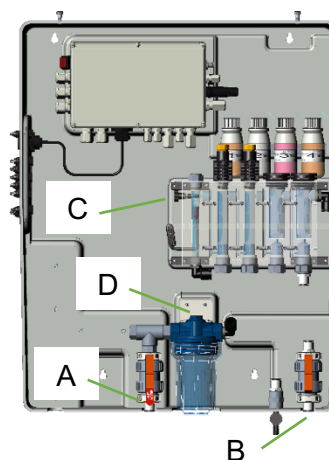

5.3 REGULAÇÃO DO FLUXO

O fluxo de água deve ser ajustado usando a válvula indicada na figura em baixo



Figura 18 Torneira de taxa de fluxo

6 MANUTENÇÃO

Para assegurar sempre o desempenho ideal do equipamento, deve ser submetido regularmente a operações de manutenção. Também recomendamos seguir os nossos programas de manutenção.

Em baixo é possível encontrar uma indicação dos intervalos de manutenção máximos:

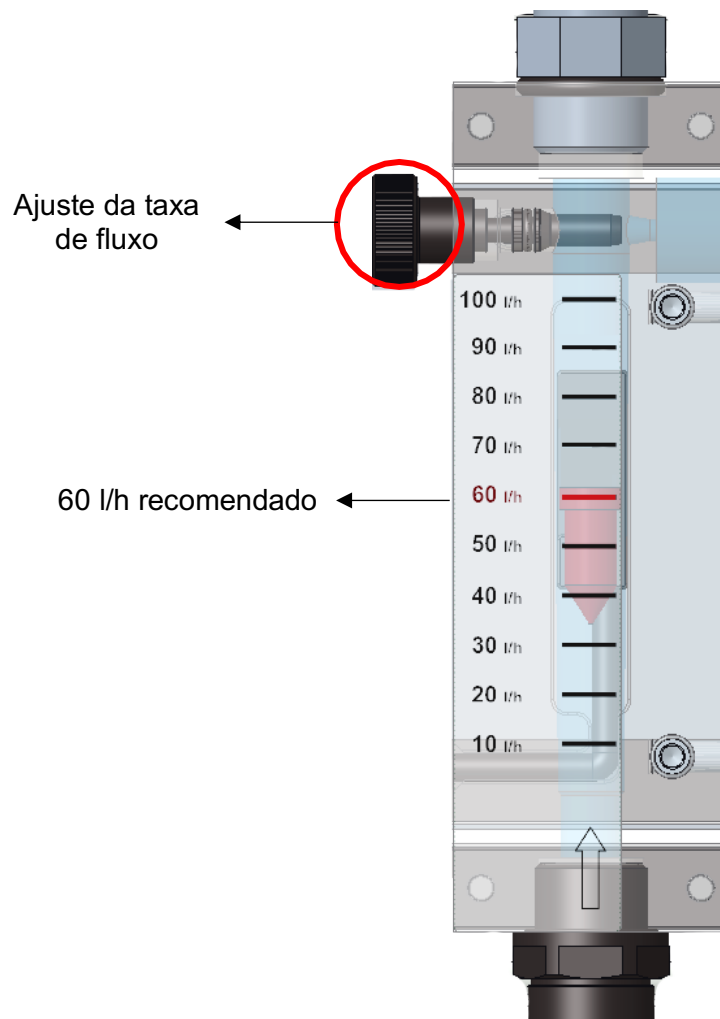
Operação de manutenção	INTERVALOS DE TEMPO			
	1 mês	2 meses	3 meses	6 meses
Limpeza geral do sistema				X
Limpeza da rede do filtro de água	X			
Inspeção do circuito hidráulico		X		
Limpeza da sonda	De acordo com o manual de instruções do elétrodo/sonda.			

ATENÇÃO



Antes de realizar qualquer operação de manutenção, desligar o equipamento eletricamente pressionando o interruptor principal na linha onde este está colocado.

ATENÇÃO



Antes de realizar qualquer operação de manutenção, parar o fluxo de água que chega ao equipamento vindo do sistema e despressurizar abrindo completamente a válvula de amostragem.

6.1 LIMPEZA GERAL DO SISTEMA

Realizar esta operação uma vez por mês.

Limpar regularmente todas as superfícies do equipamento. Usar apenas um pano húmido sem adicionar qualquer solvente ou produto.

6.2 LIMPEZA/SUBSTITUIÇÃO DO FILTRO DE ÁGUA

Realiza esta operação cada dois meses.

Esperar até que não haja água em chegada do circuito hidráulico.

Desparafusar o tabuleiro da unidade de filtro e remover o cartucho de filtro do seu interior; ter cuidado para não perder as juntas.

Colocar o cartucho sob água corrente e remover todos os detritos do filtro usando uma escova macia. Voltar a montar o cartucho do filtro e o tabuleiro do filtro no sistema, prestando atenção para recolocar corretamente as juntas.

Fechar completamente a válvula de amostragem e restaurar o fluxo de água no circuito, abrindo as válvulas gradualmente e libertando o ar do sistema. Reativar o sistema eletricamente e verificar as condições de operação depois de ter executado o teste inicial.

6.3 LIMPEZA DO ELÉTRODO/SONDA

Consultar o manual de instruções do elétrico/sonda antes de realizar esta operação.

Esperar até que não haja água em chegada do circuito hidráulico. Desconectar os cabos do elétrico desparafusando os conectores nas suas extremidades e os grampos de aperto, em seguida removê-los do alojamento da sonda no circuito hidráulico do sistema. Lavar a extremidade sensível com água morna e um sabonete neutro, removendo qualquer graxa residual usando um pincel com cerdas macias.

Para limpar as sondas não as esfregar com objetos abrasivos ou panos que as possam carregar eletrostaticamente.

No caso de sujidade extrema, limpar os elétrodos usando Álcool Desnaturado. Quando as operações de limpeza estiverem completadas, reconectar os elétrodos com os seus respetivos cabos e calibrá-los sem restaurar o fluxo de água ao sistema. Quando o procedimento de calibração estiver completado, desligar o sistema eletricamente e substituir os elétrodos no alojamento da sonda. Reconectar a alimentação elétrica e o fluxo de água ao sistema depois de fechar a válvula de amostragem.

6.4 INSPEÇÃO DO CIRCUITO HIDRÁULICO

Realiza esta operação cada seis meses.

Inspecionar visualmente o circuito hidráulico do equipamento depois de o desligar eletricamente. Em presença de vazamento de líquido, danos nos tubos ou qualquer problema de vedação, agir no circuito hidráulico apenas depois de ter interrompido o fluxo de água que chega à estação e despressurizar o sistema abrindo a válvula de amostragem.

Substituir as partes danificadas apenas por peças sobressalentes originais ou recomendadas.

ATENÇÃO



Não deixar impurezas dentro do circuito hidráulico que o poderão entupir.

ATENÇÃO



Fechar a válvula de amostragem antes de reconectar o fluxo de água ao sistema. Restaurar a pressão do sistema procedendo gradualmente e depois alimentar o equipamento.

7 RESOLUÇÃO DE PROBLEMAS

Falhas mecânicas	
O fluxo dentro da célula de medição é muito baixo	Verificar o selo dos o-rings Verificar se o filtro está entupido Verificar as válvulas de entrada e saída Verificar a válvula de amostragem
Falhas elétricas	
Sem sinal luminoso, ecrã desligado	Verificar que o equipamento esteja alimentado corretamente (ficha e tomada). Se o equipamento permanecer inativo, por favor contactar o nosso Centro de Assistência
Medições Incorretas	Verificar atentamente a calibração, em caso de dúvida fazer reset ao instrumento recolocando-o às configurações de fábrica. Verificar que as sondas estejam a funcionar corretamente e verificar o seu estado de desgaste

Por vezes poderá vazar líquido de uma conexão frouxa ou porca, ou simplesmente devido à ruptura do tubo de fornecimento de água. Quando a fuga foi eliminada, é necessário limpar e secar qualquer água residual no sistema, que poderá danificar as partes em contacto por estagnação.

8 APÊNDICE

PRESTAR ATENÇÃO



Este SEPARADOR está protegido por palavra-passe. É indicado neste manual apenas por questões informativas.

APÊNDICE 1 - CONFIGURAÇÕES DE FÁBRICA



Figura 19 Configurações de Fábrica

8.1 VERSÃO PLUS

Permite seleccionar o tipo de versão que se deseja obter:

- PLUS 1 (Guardian NN 1): Livre de Cloro 10 ppm e Temperatura
- PLUS 2 (Guardian NN 2): Livre de Cloro 2 ppm e Temperatura
- PLUS 3 (Guardian NN 3): Livre de Cloro 10 ppm, pH e Temperatura
- PLUS 4 (Guardian NN 4): pH, Redox e Temperatura
- PLUS 5 (Guardian NN 5): Livre de Cloro, pH, Redox e Temperatura
- PLUS 6 (Guardian NN 6): Livre de Cloro, pH, Redox, Cloro Combinado, Turbidez e Temperatura
- PLUS 7 (Guardian NN 7): Livre de Cloro, pH, Turbidez e Temperatura

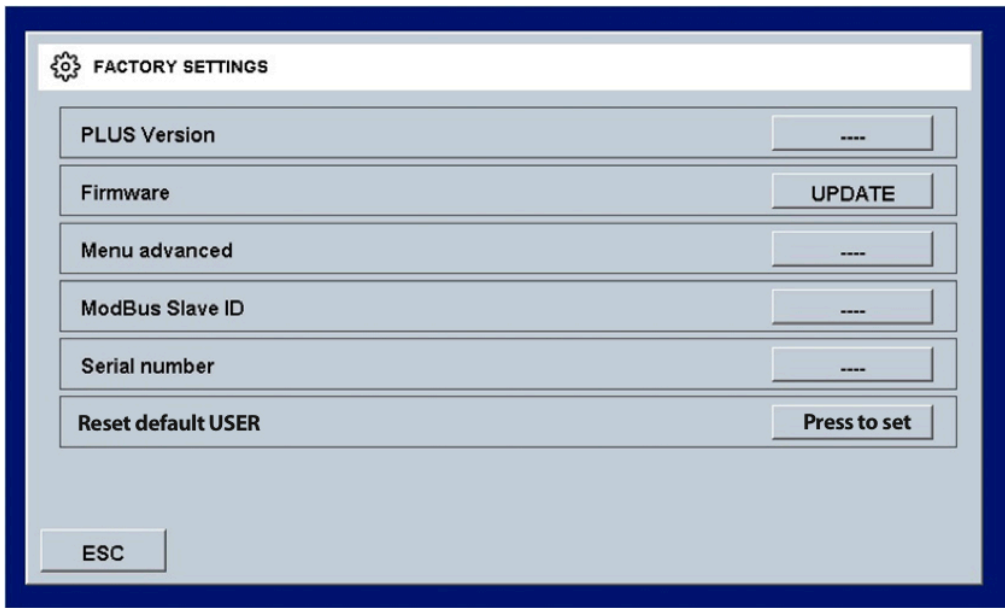
8.2 FIRMWARE

Permite atualizar o firmware: o ficheiro de firmware deve estar em uma pen USB, que deve ser inserida antes de se pressionar OK no Separador “Press OK to Start” [Pressionar OK para Iniciar]



Figura 30 Atualização Firmware

8.3 MENU AVANÇADO

permite definir o modo avançado, desbloqueando alguns menus escondidos do modo padrão (ON/OFF)

8.4 MODBUS SLAVE ID

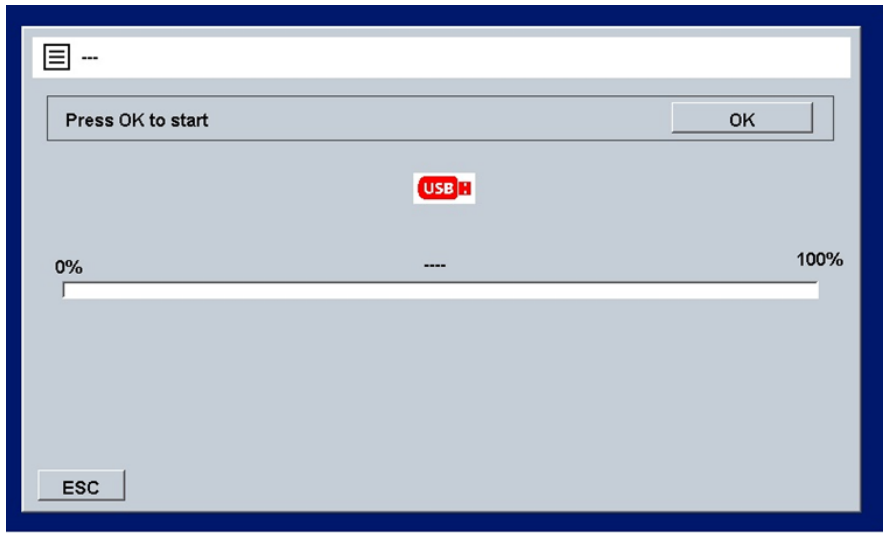
Permite modificar o ID slave, inserindo um novo (ID=1 padrão)

8.5 NÚMERO DE SÉRIE

Permite modificar o número de série do instrumento

8.6 RESET UTILIZADOR PADRÃO

Permite fazer reset a todos os parâmetros e restaurar as configurações de fábrica.

8.7 CONEXÃO A FLUIDRA CONNECT

Conexão ao gabinete de controle Connect & Go

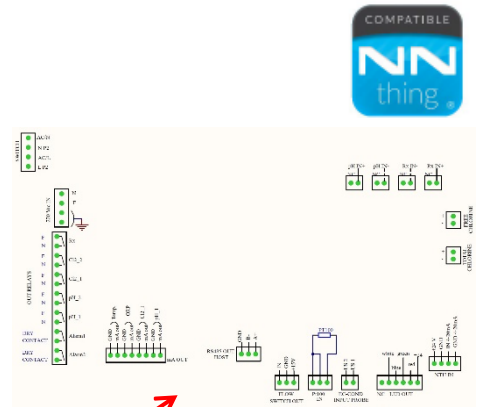
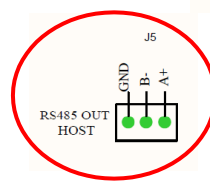
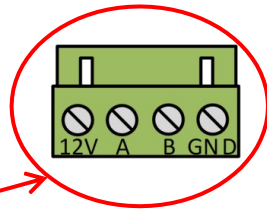

Conexão:

Connect & Go	12V	A	B	GND
Guardian Pool	Não usado	A+	B-	GND

Conexão à Connect Box

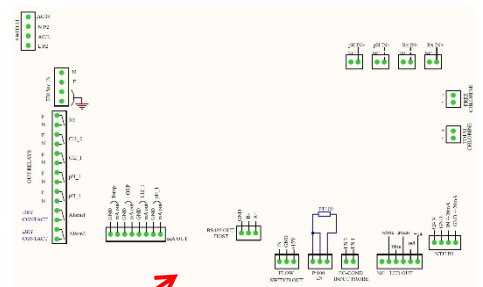
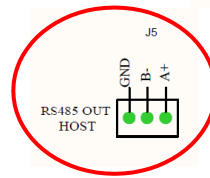
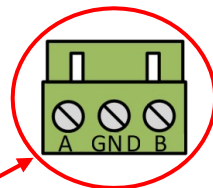
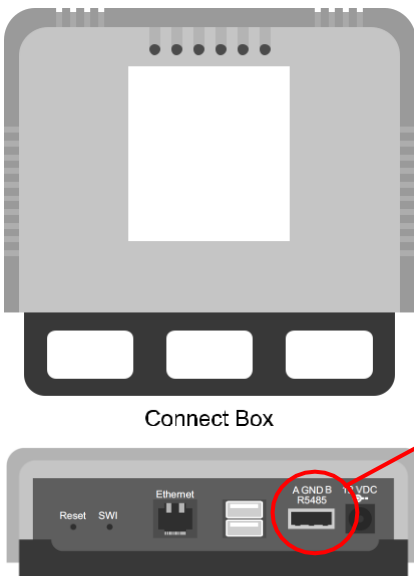

Conexão:

Connect Box	A	B	GND
Guardian Pool	A+	B-	GND