

KAHUNA  CHAIR®

KAHUNA MASSAGE CHAIR
SM 7300
MANUAL



FUNCTION INTRODUCTION

1. With our national patented massage chair, this advanced massage chair can provide you a very comfortable massage on neck and back by doing the different techniques like kneading, tapping, pressing, knocking and shiatsu. This chair provides comfortable human touch massage.



2. With acupuncture point tracking detecting function. It can supply exact massage according to different people with different body height and shape.



3. Combined with human body engineering researches and development of elongate L-shaped S-curve guide, make you fully enjoy intimate massage from head to leg, and achieves the result of rapidly alleviated pressure of the spine.

4. One-button press to perform zero gravity lies down function. It can effectively places the pressure on spine and joints, allowing you to experience the real zero gravity.



5. The forward sliding function of 3 inches from the wall. The backrest and seat frame move together, that can take full advantage of space, the design is full of humanization and will give you perfect feeling.

6. Uniquely designed foot part with 3 different massage techniques on the foot part with gentle air bag force to stimulate the sole.

7. Leg parts equipped with multiple airbags, perform pulse air pressure massage on legs, to promote blood circulation, and restore the vitality.

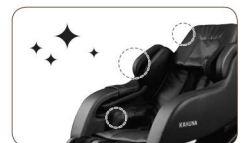

8. Air pressure squeezing massage on your arms, which can promote blood circulation of blood capillary.

FUNCTION INTRODUCTION

9. The seat comes with gentle squeezing massage powered by air bags, relaxing the stressed muscle and quickly eliminates tiredness.

10. The legrest and foot parts can be adjusted to any angle that you desire, It can be extended and retracted within the range of 12 inches, suitable for different people to use.



11. Humanized design high resolution colorful TFT big screen controller, it can display the massage parts, methods and status at the same time.





KAHUNA MASSAGE CHAIR®

BEST 3D ZERO GRAVITY MASSAGE CHAIR®



Please read and follow all safety and operating instructions listed in this user manual prior to use. Basic precautions should always be used when operating an electrical appliance.

Safety instructions	1
External structure parts	5
Internal structure parts	6
Mechanical components diagram	7
Mechanical components list	8
Installation	9
The adjustment before massage	15
Manual control	17
Operation instruction & function illustration	21
After massage	23
Clean and maintenance	24
Malfunction guide	25
Technical data	26



Please keep this manual in a safe place for future reference.





Note We reserve the right for design modification. It is subject to change without notice. The pictures in this manual are only for reference. Please refer to the actual product.

SAFETY INSTRUCTIONS

- Please read this manual carefully to make sure the installation and operation of the massage chair is correct.
- “Safety instructions” are provided in both warning and caution for important safety information.

Both warning and caution are important safety caution, please be more cautious.

 Warning	This sign indicates warning of causing possible death or hurt to body.
 Caution	This sign indicates caution of causing possible pain or damage to body.

	This sign indicates forbidden behavior.		This sign indicates self disassembly is forbidden.
	This sign indicates must follow instruction to operate.		This sign indicates correct operation of cable.

- The following should be kept for any further references.





Warning



	<ul style="list-style-type: none"> • Osteoporosis patient; • People with heart disease including embedded pacemaker or other medical electronic device inside the body; • For pregnant women or people with health issues, please consult doctor before use ; • Patients with a high fever forbid to use this machine. • Perceptual disabilities patients forbid to use this machine. • People over 80 years old forbid to use this machine. • Kids and the drunk people are not allowed to use the chair; • Please don't sleep in the chair. • Don't use the chair when your body is wet. 	<p>People who are not suitable to use the chair</p>
	<ul style="list-style-type: none"> • Make sure there are no kids or pets or other objects around (under, behind or in front of) the chair at the moment of backrest, leg-rest up/down or leg-rest retraction/extension from reclining position. • During operation, if body is being abnormal, please stop the operation and go consult with your physician. • Please do not take strong massage on the head. • Do not massage belly or knees, be careful when massaging neck. • Children or pets are not allowed to play on the chair especially during massage. Standing or sitting on the back or armrest is not allowed either. • Those who move around with difficulty or can't express themselves must be taken care of strictly and continuously during massage. 	<p>Accident/injury</p>
	<ul style="list-style-type: none"> • Insert the plug of the chair into correct and suitable power socket. • Make sure the plug is completely inserted into the socket to reduce short circuit or fire risk. • Unplug the power when not in use, stop all massage functions and turn off on/off key before unplugging. 	<p>Fire and electric shock</p>
	<ul style="list-style-type: none"> • It is prohibited to use the massage chair while any items are covering the massage chair ventilation holes. • Massage cushions of the chair are not allowed to fold for storage. • The machine is forbidden for no-load running for a long time. 	<p>Accident</p>
	<ul style="list-style-type: none"> • Power cord, plug, socket can't be used in broken or loose contact condition. • Don't use other electric power except rated voltage in case of fire, electric shock or any breakdown. • Any broken, re-process, knotted, twisted power cord or pressed under heavy cargo is not allowed to use. 	<p>Fire and electric shock</p>
	<ul style="list-style-type: none"> • If the chair is dysfunctional, or is broken, splashed with water or falls into water, please have it repaired by professional repairman or send the chair to assigned service agent. Self-modification, disassembly or maintenance is forbidden. • If power cord or plug is damaged, please don't replace it yourself, please contact us or appointed dealer for replacement. • To avoid electric shock or body injury, please don't open or disassemble any part of the chair, there is not any attached part of the chair for maintenance by customers. • Check leather or cloth material on the back and other areas is broken or not. If broken, even though it is small, please stop using the chair, unplug the power and have it repaired. 	<p>Disassembly and maintenance</p>

SAFETY INSTRUCTIONS

Caution

	<ul style="list-style-type: none"> • Please operate the chair when it is flat or on leveled place 	To avoid sudden falling.	
	<ul style="list-style-type: none"> • Position the chair 3 inches from the wall to allow for sufficient space to recline up and down. 	To make sure the back lying.	
	<ul style="list-style-type: none"> • The maximum suggested operating time is 30 mins. 10 mins for each position beginning with the slight- step massage. Along continuous massage in the same position may cause uncomfortable feeling. 	Too long time massage is bad for your body.	
	<ul style="list-style-type: none"> • Before sitting on the chair to avoid injury please inspect everything to confirm that the massage heads are in the correct position. 	To avoid accidental injury.	
	<ul style="list-style-type: none"> • Please make sure that the power switch is on "off" position before inserting the plug into the socket. 		
	<ul style="list-style-type: none"> • Turn off all controls before removing plug from outlet. 	To avoid the accident when turn on the power.	
	<ul style="list-style-type: none"> • Make sure the plug is completely inserted into the socket. 	To reduce short circuits and any fire hazard.	
	<ul style="list-style-type: none"> • Checking whether there are any damages on the wire and make sure there are no water or rubbish on the wire. • Installing the wire in a correct way. The plug must be inserted into socket with the connect, the connect couldn't be bent or cut off. 	To avoid electric shock in any leakage or breakdown.	
	<ul style="list-style-type: none"> • Don't press with hands or step on the massage heads with feet. • Don't put hands between the working massage heads. • Don't put hands or feet in the gap of mechanical parts. • Don't drop or insert anything into the slot of massage chair. • Don't stand or sit or put anything on the backrest, armrest, or leg-rest. • Don't stand on the chair during operation. • Don't move the chair during operation. • Don't pull out the plug or turn off the power during operation. • Don't put your hands or head between leg-rest or beneath. • Don't use the massage chair while wearing hair ornaments. • Don't put hard things in pocket when take buttocks and huckle massage. • Don't sit or press on the backrest when the chair is in reclining position. • Don't use on bare skin or wearing thin clothes, thin clothes may cause better massage effect, But it also may cause irritation to the skin or cryogenic burns. 	To avoid accidents or injury	
	<ul style="list-style-type: none"> • Keep the chair away from heat, wet, sharp things and corrosive, inflammable, explosive environment. • To use electric blanket or other heating products on the chair is forssiden. • Don't put in the space of dust serious or corrosive gas environment. • Don't put the chair in a small space places or use in the bad air circulation places. 	To avoid fade, discolor on upholstery or hardened, deteriorated on PU.	
			<ul style="list-style-type: none"> • Keep the chair away from stove or other heating products.
			<ul style="list-style-type: none"> • Don't put the chair directly under the sun or other high temperature places.
	<ul style="list-style-type: none"> • Don't use the chair in outdoor. 		

Caution

	<ul style="list-style-type: none"> • Don't use or store the chair in the wet environment like near the swimming pool, or bathroom. • Keep the chair and remote control dry at all time. • Don't use the chair when your body is wet. 	To avoid leakage or electric shock.
	<ul style="list-style-type: none"> • Make sure to install the wire in correct way(Incorrect install way may cause electric shock. If you don't know how to install, please find a professional electrician) • Don't use plug adapter (If the enclosed plug doesn't match with socket, please don't change the plug by yourself and find a professional electrician to install a matched socket.) 	To avoid electric shock.
	<ul style="list-style-type: none"> • Unplug the power before cleaning the chair. • Unplug the power after using the chair. 	To avoid electric shock or fire harzard.
	<ul style="list-style-type: none"> • Unplug the power when any damage on the power. • Hold the plug to unplug the power but to not try to pull the wire to unplug the power. 	
	<ul style="list-style-type: none"> • Please turn off the power switch and unplug the power after massage. 	To avoid accidents
<ul style="list-style-type: none"> • Unplug the power immediately when electricity goes off. 	To avoid damage or accidents when power on again.	



Warning : 1.Do not use it when gets wet.
 2.The disabled or people who need supervision.
 3.The chair has heat function, people who are insensitive to heat must pay high attention.

Grounding instruction

The chair is equipped with a cord having a grounding conductor.The plug must be plugged into an appropriate socket that is properly installed and matched with the plug.

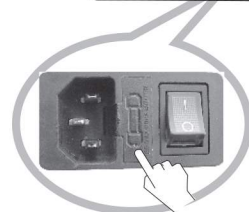
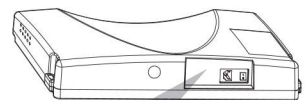













Replace fuse

When the fuse is burned out, please turn off the switch and unplug the power. Open the electrical compartment lid which is located in the switch box. Using a same size fuse to replace the old one, then cover the lid or you can find an electrician to replace the fuse.



Earth wire is not allowed to be in these places

Gas pipe: probably cause explosion or fire.
 Phone wire and lightning rod: probably cause electric shock and fire when thundering.
 Water pipe: earth wire is useless where there are plastics

	<p>1. When powered on, the chair will automatically begin in a preparation position. When powered off, the chair will go back to its original position.</p>
	<p>2. In ON status, press it to enter quick relaxation auto program, there is relative status screen display. Default massage time is 8 minutes. Press it again to stop.</p>
	<p>3. Press this button to stop all the on-going massage immediately. All buttons will not work. If user wants to continue massage, please press the On/off button to turn on the controller.</p>
	<p>4. Button in Main interface to switch to menu interface; user can set different functions or programs for massage chair. Press it in Menu again to return to main interface.</p>
	<p>5. This button will help you navigate between several auto and special programs your massage chair has to offer.</p>
	<p>6. Direction button has 4 buttons for up, down, left and right. In Menu interface is the navigator button, user can press Up or Down to choose menu fast, and press Left or Right to enter previous or next menu, What' s more, Up and Down button can be used to adjust massage position in acupuncture point tracking detecting finish and point massage.</p>
	<p>7. This button will confirm your menu choice.</p>
	<p>8. Keep pressing this button, legrest goes down; release it, legrest stop moving. Controller screen will show position adjusting••• when adjusting the position of massage chair.</p>
	<p>9. Keep pressing this button, legrest goes up, if you release it, then the legrest stop moving. Controller screen will show position adjusting••• when adjusting the position of massage chair.</p>
	<p>10. Keep pressing this button, backrest goes up, legrest goes down, release it, than backrest and legrest stop moving. Controller screen will show position adjusting when adjusting the position of massage chair.</p>
	<p>11. Keep pressing this button, backrest go down, legrest go up, release this button, I backrest and legrest stop moving. When adjusting sitting position, it shows seat position adjusting••• in controller screen.</p>
	<p>12. In On status, press this button, massage chair will go into zero-gravity position, press it again to return to default position.</p>

INTERNAL STRUCTURE PARTS



MECHANICAL COMPONENTS DIAGRAM

| Explosion diagram |

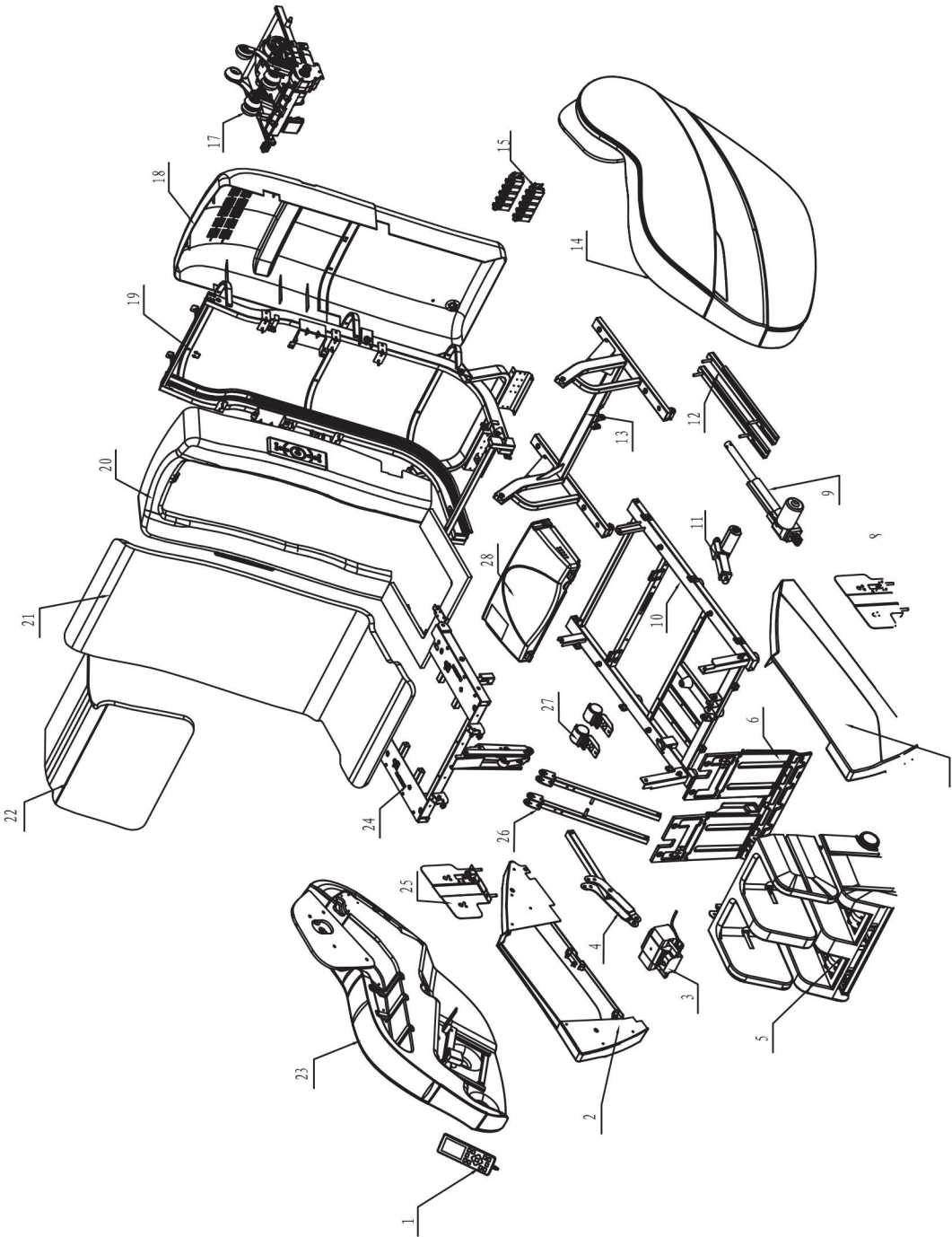

MECHANICAL COMPONENTS LIST

No.	Name	Q'ty	No.	Name	Q'ty
1	Remote control	1	22	Pillow	1
2	Right side fender	1	23	Right armrest assembly	1
3	Air pump assembly	1	24	Seat frame surface assembly	1
4	Connecting rod	1	25	Right side of seat airbag assembly	1
5	Legrest & footrest	1	26	Seat support bar	2
6	Front fender	1	27	Castor	2
7	Left side fender	1	28	Power case assembly	1
8	Left side of seat air bag assembly	1			
9	Backrest electric actuator	1			
10	Bottom seat frame assembly	1			
11	Footrest electric actuator	1			
12	Sliding rail	2			
13	Top seat frame assembly	1			
14	Left amrest assembly	1			
15	Electric magnetic valve	2			
16	Headrest Plastic Parts Assay	1			
17	Massage machine	1			
18	Back cover assembly	1			
19	Back frame assembly	1			
20	Backrest plastic front cover and seat plate assembly	1			
21	Back and seat cushion	1			

INSTALLATION



Youtube installation video available at <https://youtu.be/FQloW2eCoFA> or search: **SM7300 Installation** Video on Youtube.



Step 1. How to move the chair

- 1 Slowly take the chair out of the box. With the help of another person, grab the left and right metal frame of the massage chair.

Note Please place the remote on top of the chair seat in order to avoid it getting crushed when placing down the chair.



- 2 Take out the remainder of the assembly items and place them to the side.



Back seat cushion



Electric power cable



Remote control



Left shoulder massage device



Right shoulder massage device



Remote Control Pocket

Hold the metal seat frame and take the chair out of the box.

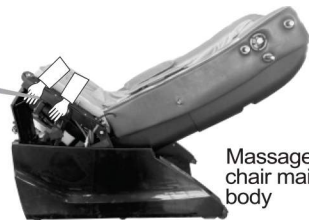

Massage chair main body

- 3 Slowly take out the right and left side of the arm panels from the carton box and place them to the side.



Right armrest



Left armrest

- 4 Carefully take out the leg rest piece from the largest carton box.



Step 7. After the assembly

After the assembly, please operate the chair in this order:

- ❶ Plug the cable line in the hole a on the power box as shown in the right picture. Hole a connect with one end of cable line.
- ❷ Insert the plug of cable line into the socket.
- ❸ Switch on. (Switch on/off "0/1", press I down to turn it on.)
- ❹ Enjoy the massage by using the remote control.



Make sure the switch is off before you insert the plug of cable line into the socket.

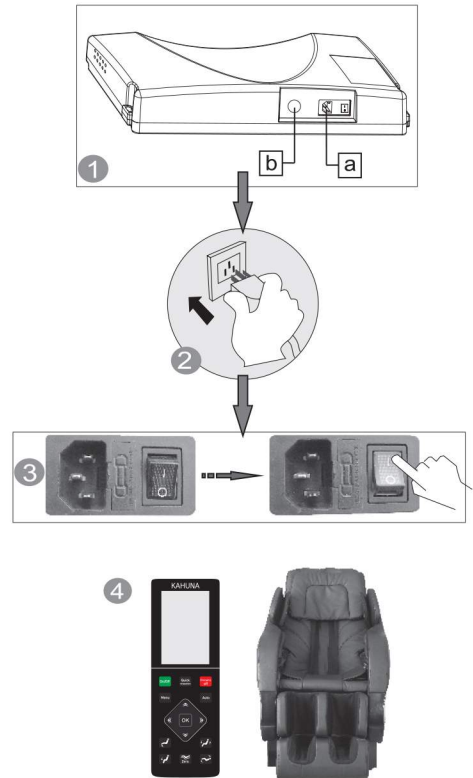

Step5. Set up the seat side air bags and remote control

How to set up the seat side air bags

- ① Take out the left and right seat side air bag, put the zipper side towards the seat cushion, insert the two cylinder pins into the holes of seat frame firmly.
- ② Connect the air tube with the air cock behind the seat firmly.

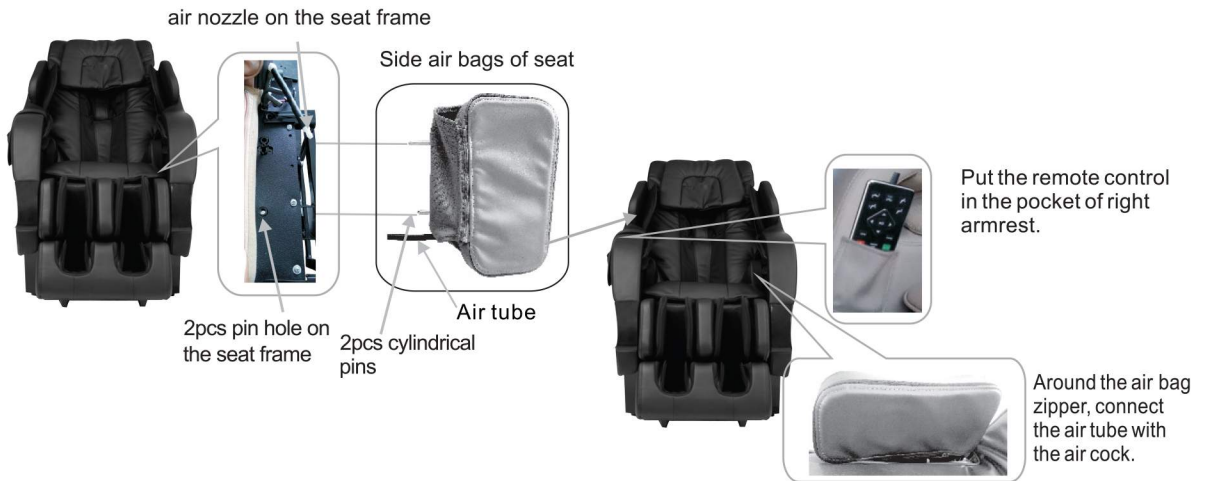

INSTALLATION

| Step6. Put the back |

Set up the cushions on the backrest and connect the two parts with zipper and velcro.



Back seat cushion



Remote Control Pocket

Tip

In order to get exact correct body test data for comfortable massage effect, when you sit on the chair, please make the bottom rim of the head pad level with your ears before zippering the said two parts.

⚠ Installation of back seat cushion should pay attention to: make the middle part of back cushion align to the middle part of backrest

Zipper position on the back cushion

Back seat cushion zipper connect to seat, connect the velcros between them.

① Insert the velcro of remote control pocket through above the right arm upper airbag and connect the velcro together.

② Back seat cushion connect to upper backrest by zipper

Head pad

Backrest

Back seat cushion

③ Back seat cushion connect to the two sides of backrest by zipper

Step2. Massage chair position return

After taking out the main chair body, plug in the power cord and turn on the switch. The chair will recline to the up position. Unplug the power cord to make the chair retain this position

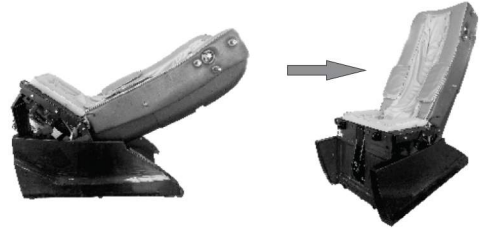

Step3. How to assemble the legrest

Install the legrest to the main body,

1 Unscrew the 2 screws from the latches on the legrest portion of the main chair body.

2 Connect the 3 air tubes to the air connectors on the main chair body. Color specific from left-to-right: grey, brown, and black.

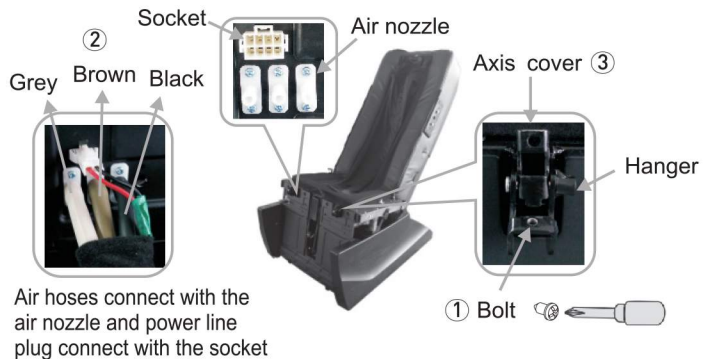

3 Connect the power line to the power socket tightly.

4 Raise the 2 latches on the legrest portion of the main body, place the legrest into them, lower the latches, and screw the 2 screws back in tightly.

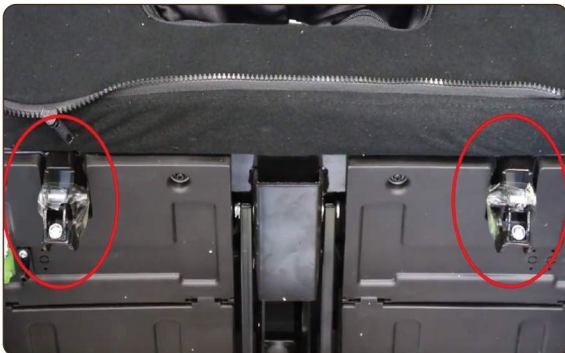

INSTALLATION

Step4. How to assemble the left and right armrest

- 1 Unscrew the M6 screw on the seat frame with a cross screwdriver.
- 2 While pushing down the release button on the fixed hole located in the rear section of the side panel, insert it into the short metal rod sticking out from the top section of the main chair body.
- 3 Insert the square tube like metal piece on the side panel to the side piece located on the rear end of the main chair body. Slightly move the armrest to make the bolt holes align. Screw the M6 screws into the holes (First fix the screw for the rear end, then the front)
- 4 Connect the air hoses of the same color on the side panel to the ones on the seat.



THE ADJUSTMENT BEFORE MASSAGE

Environment

⚠ Caution



Don't use the chair in wet places like near the swimming pool and bath room to avoid leakage or electric shock.



Don't use under the sunlight or near stove or other heating place to avoid upholstery being deteriorated.



Please use chair in a flat place to avoid chair falling or noise or other unexpected troubles.

• Check places in front

Check the areas when back and leg are extending, make sure no people, pets or other things are around.



• Check power cable, plug

- (1) Clean the dust on plug on time. (using dry cloth).
- (2) No damage, re-do, bend, stretch, tie or press with heavy thing (especially can't be pressed by the chair) on power cable.



Check environment

Space size for using the chair

- At least 3 inches from wall.



- At least 11.8 Inches in front of the leg.

Check surroundings

When the backrest or legrest reclines or extends, check any person or things in every direction and space size.



THE ADJUSTMENT BEFORE MASSAGE

How to move massage chair

Caution

Don't move chair when it's working in case of accidents or damage.

How to move

- Bind the cables and put them in the seat to avoid damage when moving.
- If you plump the chair, it may damage the inner parts of the chair.
- Don't use the castor if the floor is wooden or other easy damaged material. It will need 2 or more people to lift the chair.
- Make sure the power is off and the plug doesn't touch the floor. (It's better to let the chair in standing status to avoid the back crashing the floor)



Normally

Lift up the legrest to make the gravity fall on the castor. Then push chair to destination and set it down.



Please hold the footrest to move the chair as shown in the picture in case any scratches on the leatherette.

Adjustment before massage

Before adjustment

- Please make sure the massage head in the seat part before sitting on the chair.



- To avoid injuries caused by wrong position of the massage head.

Acupuncture point tracking

Detecting confirm if massage head can't detect when acupuncture point position detecting, shoulder position was default to the middle position.

The correct position

Lie on the backrest and keep head on the pillow. When body scan is complete, there will be a buzzer or remote control. Press the up or down key to adjust the shoulder position if necessary.



***Avoid the wrong detection of shoulder height during body scan, please follow above direction, otherwise you won't get a good massage.**

Suggestion











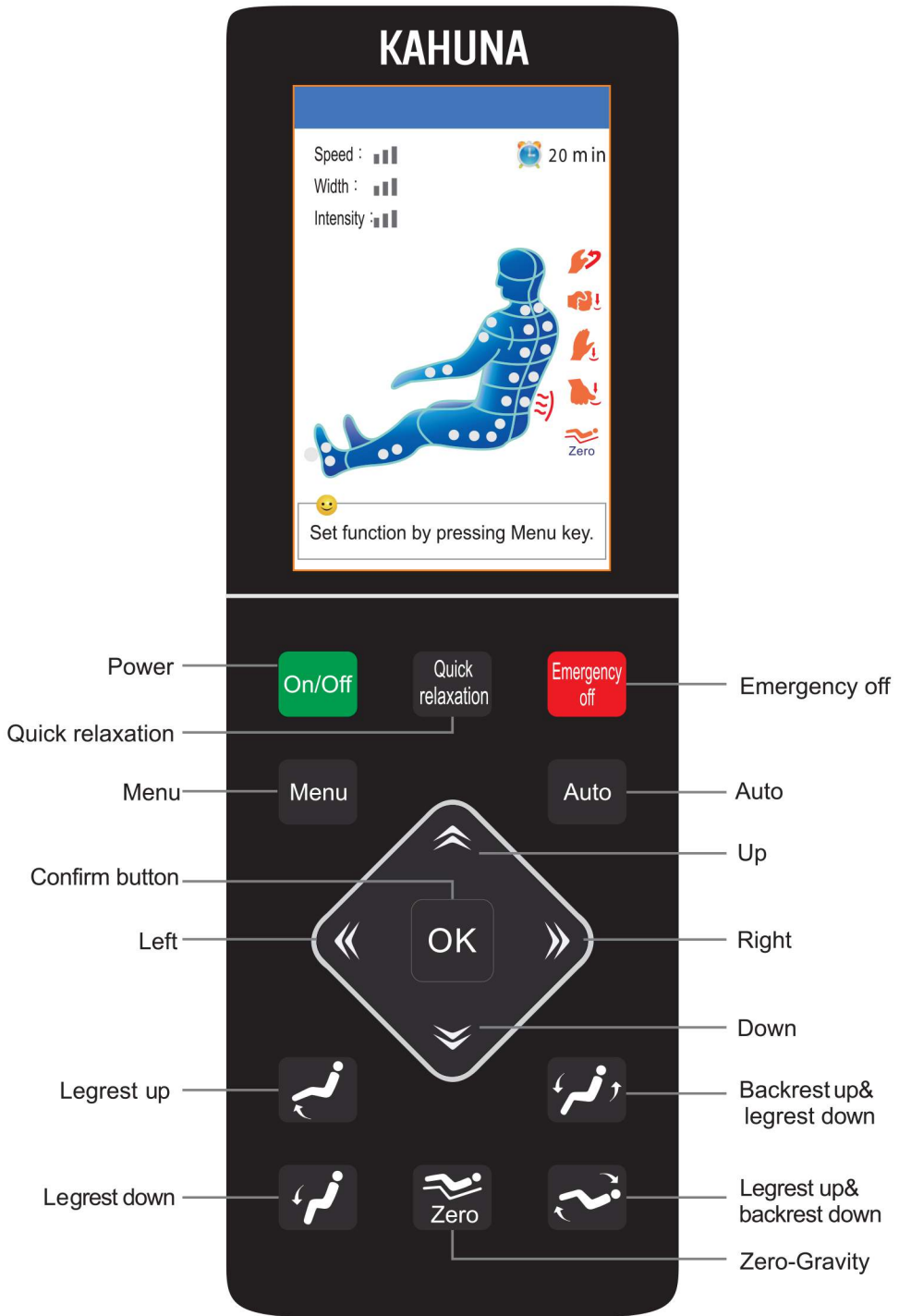



- When you feel the intensity isn't strong enough, take off the pillow or cushion.

- Because the chair is heavy, it may ruin your floor in long time setting. Please put a blanket or other soft things to protect your floor.



MANUAL CONTROL



	<p>1. When powered on, the chair will automatically begin in a preparation position. When powered off, the chair will go back to its original position.</p>
	<p>2. In ON status, press it to enter quick relaxation auto program, there is relative status screen display. Default massage time is 8 minutes. Press it again to stop.</p>
	<p>3. Press this button to stop all the on-going massage immediately. All buttons will not work. If user wants to continue massage, please press the On/off button to turn on the controller.</p>
	<p>4. Button in Main interface to switch to menu interface; user can set different functions or programs for massage chair. Press it in Menu again to return to main interface.</p>
	<p>5. This button will help you navigate between several auto and special programs your massage chair has to offer.</p>
	<p>6. Direction button has 4 buttons for up, down, left and right. In Menu interface is the navigator button, user can press Up or Down to choose menu fast, and press Left or Right to enter previous or next menu, What' s more, Up and Down button can be used to adjust massage position in acupuncture point tracking detecting finish and point massage.</p>
	<p>7. This button will confirm your menu choice.</p>
	<p>8. Keep pressing this button, legrest goes down; release it, legrest stop moving. Controller screen will show position adjusting••• when adjusting the position of massage chair.</p>
	<p>9. Keep pressing this button, legrest goes up, if you release it, then the legrest stop moving. Controller screen will show position adjusting••• when adjusting the position of massage chair.</p>
	<p>10. Keep pressing this button, backrest goes up, legrest goes down, release it, than backrest and legrest stop moving. Controller screen will show position adjusting when adjusting the position of massage chair.</p>
	<p>11. Keep pressing this button, backrest go down, legrest go up, release this button, I backrest and legrest stop moving. When adjusting sitting position, it shows seat position adjusting••• in controller screen.</p>
	<p>12. In On status, press this button, massage chair will go into zero-gravity position, press it again to return to default position.</p>

LCD display graphic description

Main interface



Press "on/off" button when chair power is on, a buzzer beeps once short it. LCD screen display boot screen, after 2-3 seconds it displays the main interface and enter standby mode. Main interface show massage position, method, time, heating current massage status etc., all information will be updated timely when the chair start working.

- Massage function
- Kneading
 - Tapping
 - Knocking
 - Pressing
 - Zero gravity
 - Massage time left



Menu interface



Press the "menu" button to enter the main interface, it will switch to the menu interface, user can set all massage function. Press the "menu" button in the menu interface will exit and return to the main menu interface.

- Auto massage press the "menu" button, the cursor stop on auto can choose the auto massage mode, and also there are five massage program menu item by default, and 4 special programs.

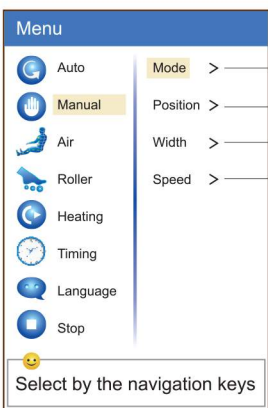

Manual press "menu" key, select manual massage by the navigation key, press the "ok" button, there are four options: mode, position, width adjustment, speed adjustment: select the corresponding function, then press the "ok" button to enter the next menu, select the desired massage method, position, width and speed regulating function.

When massage chair in manual fixed point work modes, users can use up/down button to adjust massage position, information for "massage position adjusting•••" will be show at the bottom of the display screen.

LCD display graphic description

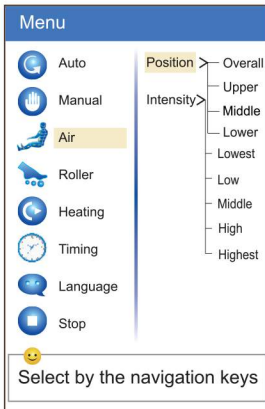

Air

There are two kinds of air pressure related function: Position and Intensity; Choose the corresponding function, then press "ok" to enter next menu and choose required function.

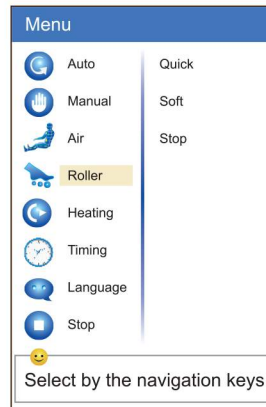

Roller

This menu is for foot massage intensity and off option.



Heating

Health therapy option. The heating symbol will high light display on the interface. With opening and closing two options on the waist.

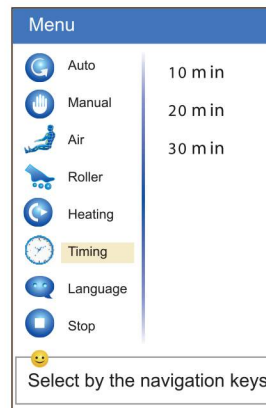

Timing

Time control menu up to 30 min every 10 min interval.



Language

Press "menu" key, select language through the navigation key, then select the preferred language.



Stop

press "menu" key, select stop through the navigation key, it will stop massage, and it will turn back to main interface.



After power is on, the first time to use auto program, massage chair will start acupuncture point position detecting, and "acupuncture point tracking ●●●" will be shown on screen display. After acupuncture point tracking detecting is finished, buzzer will tick 5 times (once every second), meanwhile, the massage machine is

located in shoulders position, if user think the position is not proper, press Up and Down to adjust, "acupuncture point adjusting ●●●" is showing on screen display.

OPERATION INSTRUCTION AND FUNCTION ILLUSTRATION

ON/OFF

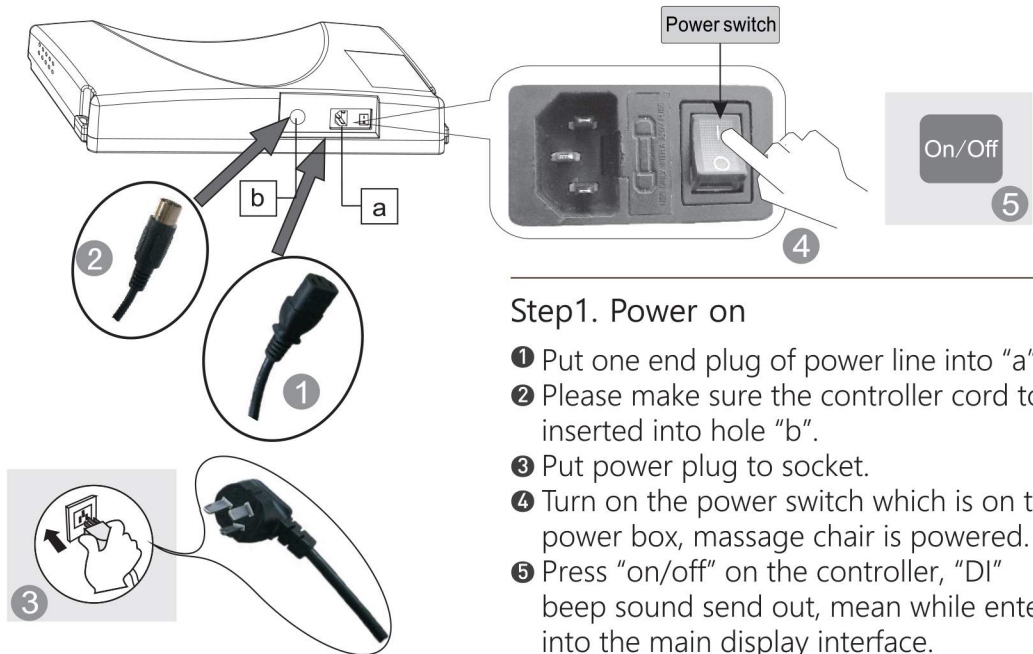

Step1. Power on

- ① Put one end plug of power line into "a" hole.
- ② Please make sure the controller cord to be inserted into hole "b".
- ③ Put power plug to socket.
- ④ Turn on the power switch which is on the power box, massage chair is powered.
- ⑤ Press "on/off" on the controller, "DI" beep sound send out, mean while enter into the main display interface.

Step2. Massage

- ① Operate according to controller operation instruction.
- ② When massage stops, massage machine will return to the default position, mean while "shutting down" will be displayed on the controller, controller off after 2-3 seconds.

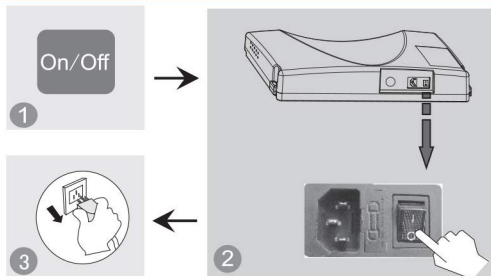

Step3. Turn off the power

- ① When the chair is on, press on/off button to turn off the massage chair and it will restore automatically.
- ② Turn off the power switch on the bottom of the back of chair after the rollers stay at storage position.
- ③ Unplug the power plug from the socket.



- ① Before using, pull up the pillow, back cushion etc. to check if the PU material is broken, if there is damage, please stop using, unplug the chair, and ask for repairment.
- ② Only plug to proper socket.



- ① Before sitting down, make sure there is no things pinched between armrest, legrest, backrest and seat of the chair.
- ② Make sure the chair is in returned position before using.
- ③ Do not stand on it when using the massage chair.

OPERATION INSTRUCTION AND FUNCTION ILLUSTRATION

Function illustration

Legrest up

Press this button on controller, legrest goes up. Release the button, legrest stops moving, the angle is locked in this position.



Legrest down

Press this button on controller, Legrest goes down. Release the button, legrest stops moving, the angle is locked in this position.



Legrest up and backrest down

Press this button on controller, backrest go down and legrest go up. Release this button, backrest and legrest stop moving, the angle is locked in this position.



Backrest up and legrest down

Press this button on controller, backrest goes up and legrest go down. Release this button, backrest and legrest stop moving, the angle is locked in this position.



Zero gravity

Press the button "Zero Gravity", backrest go down and Legrest raise up, the chair go into Zero gravity status automatically. Press the Button again, the backrest and Legrest stop moving, and it will lock at this position. However to change the angels, we can keep comfortable massage status all the time.



Legrest extend and retract

Legrest can extend or retract within a range of 12 inches.



Arm massage

Put arms between arm airbags before the embedded airbags before filled with air. It will preform pinch massage techniques to arms and hands after airbags inflating.



Shoulder massage

Multi-layer extrusion airbags is deployed on both sides of the shoulder. Achieve pressure shoulder stretch massage, relieve shoulder fatigue.



Foot roller massage

Footrest parts with roller massage and air pressure massage function. Through stimulating the foot reflex zones, and clear the body meridians, regulate and restore human organs function, improve the body resistance and immunity effectively.



- 1 Please make sure there are no people, no pets or any stuff within range for backrest to avoid unexpected hurt or property loss.
- 2 When adjusting the backrest, be careful the gap between the backrest and armrest.
- 3 When the Legrest is moving, please do not stand on or leave from the seat, and do not stop the legrest from moving in case of causing damage to the chair.
- 4 Please refer to control instruction for more details.

AFTER MESSAGE

| Restoration of massage chair |

- ① Make sure there is no people or pet or anything within the range of backrest and legrest.



- ② Make backrest and legrest restore to the normal position by controller.(or press on/off key to make backrest and legrest restore to the normal position)



- ③ Put the remote control back to the pocket after chair gets reset.



- ④ Put the pillow pad on to the right position.

- ⑤ Switch off the power.

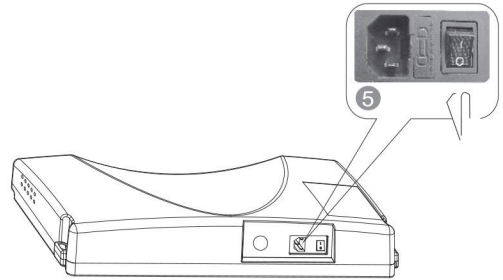

- ⑥ Unplug the electricity from the socket. (Attention: hold the right plug position)

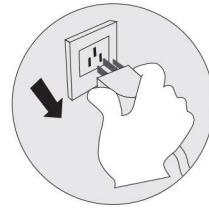

- ⑦ Clean the chair if necessary.

Attention

- After using, press on/off to end all the massage method and wait for restoration.
 - Make sure to cut the electricity to avoid any unexpected hurt to children or pets.
 - After using, turn off the power, unplug the electricity. Avoid moisture, dirt and aging of insulation in case of causing damage.
-

Synthetic leather

General cleaning

Clean with tidy, soft and dry cloth slightly.



(Chemical or medical cleaning products are forbidden)



Forbidden



If leather is dirty

- ① Dip soft cloth into 3-5% neutral detergent solution, squeeze it then clean the stain on the surface gently.
- ② Wash cloth, squeeze it and wipe with detergent.



- ③ Clean it softly with dry cloth.
- ④ Allow to dry (air blower is prohibited)

Plastic parts

- ① Dip cloth into neutral detergent, squeeze it and clean.
- ② Wipe with water-dipped but squeezed cloth.
- ③ Let it dry fully before using it.



Clean the controller

- ① Wipe with soft cloth after squeezing.
- ② Allow to dry. Propellant, diluent or alcohol are prohibited.



Forbidden



Cloth material

- ① Dip cloth into weak neutral detergent, squeeze it and clean the material surface. (Diluent, gas, alcohol are prohibited)



Forbidden



Brush the dirty parts with weak neutral detergent. (avoid excessive brushing)

- ② Excessive cleaning may cause damage to cloth material.
- ③ Wipe with water-dipped but squeezed cloth.
- ④ Allow to dry.



About cleaning

- Before cleaning, unplug the electricity, don't touch plug with wet hands.
- Make sure hands are dry when plugging to the socket.
- If failed to follow the mentioned instruction, user may get electric shock or burned.

MALFUNCTION GUIDE

FAQ and troubleshooting

Trouble	Possible reasons	Troubleshooting
The massage chair doesn't work after power is on.	Check if the control is on or not.	Open control switch
	Not selected massage function	Choose massage function
	Check whether the plug and socket in poor contact.	Make sure plug and socket are connected.
	Wire or plug has visible damages.	Please contact service @kahunachair.com for checking and replacement.
	The fuse burned out.	Replace fuse of same specification.
	Something wrong with inner circuit.	Please ask appointed or authorized maintenance man for checking and repairing.
There is beep sound inside the massager while working.	It is sound of air pump, motor and mechanical parts.	Normal sound, no need to pay attention to it.
Different height of the left roller and right roller.	Massage rollers work on shifts.	Normal, no need to pay attention to it.
Sound suddenly becomes much louder while working.	Check if it is due to long time working.	Turn off the power to have the massager rest for over half an hour before next turn working.
	Inner parts fretted away due to long time work. It's normal	Please ask appointed or authorized maintenance man for checking and repairing.
Massage function suddenly stops while working.	Suddenly power-down	Connect the electricity power again
	Setting time is up.	Turn off the power to have the massager rest for over half an hour before next turn working.
Neither the backrest nor the legrest can be lay down	Check if there are any obstacles; the chair overloads; for the sake of safety, sometimes the massage machine may automatically stop working.	Remove the obstacles; turn off the power to have the massager rest for over half an hour before next turn working.
The chair can't return to its original position.	Excessive operation; setting time is up.	Please ask manufacturer or appointed or authorized maintenance man for checking and replacement.
Electric wire or plug give out heat	It may work overload	Turn off the power to have the massager rest for over half an hour before next turn working.
	Other abnormal case	Stop using, and ask appointed maintenance man for help.

 *Note: If the troubles are not caused by above reasons, please turn off the power switch and cut off the power, then contact the manufacturer or service agent to repair your chair.*

TECHNICAL DATA

Name	SL-track Massage chair	Power	200 W
Model	SM 7300	NW/GW	Main body:198.42 lb/ 246.92 lb Armrest:39.68 lb / 61.73 lb
Input voltage	AC120V, 60Hz	Packing size	Main body 51.18x29.33x49.41 inch Armrest 44.49x 16.54x 33.86 inch
Safety design	Class 1		



KAHUNA CHAIR PRODUCT WARRANTY REGISTRATION
<https://www.kahunachair.com/services/>



Product Massage Chair

Model SM 7300

Developed by AJX Distribution LLC

11125 Knott Ave, Suite D

Cypress, CA 90630

Tel 1-855-646-9500

Email INFO@KAHUNACHAIR.COM

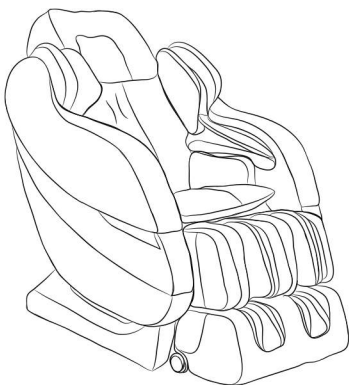

You must register warranty at www.kahunachair.com/services/

INSTRUCTION MANUAL
MODEL:SM 7300

Please read this user manual thoroughly prior to operating the massage chair. Store this booklet for future reference.