

KAHUNA  CHAIR®

KAHUNA MASSAGE CHAIR

EM8300

MANUAL





CONTENTS





Please read and follow all safety instructions listed in this user manual prior to use. Basic precautions should always be considered when operating an electrical appliance.

Safety Instructions	2
Product Components	7
Chair Installation	9
Operation Guide	11
Troubleshooting	16
Maintenance	17
Product Specifications	18



- Please read this manual carefully to make sure the installation and operation of the massage chair is done correctly.
- “Safety Instructions” are provided for important safety information. Both Warning and Caution are important safety caution, please be more cautious.

	Warning	This sign indicates warning of causing possible death or injury to body.
	Caution	This sign indicates caution of causing possible pain or damage to body.

	This sign indicates forbidden behavior.
	This sign indicates must follow instruction to operate.
	This sign indicates self disassembly is forbidden.
	This sign indicates correct operation of cable.

- The following should be kept for any further references.

SAFETY INSTRUCTION



Warning

	<ul style="list-style-type: none"> • Osteoporosis patient ; • People with heart disease including embedded pacemaker or other medical electronic device inside the body ; • For pregnant women or people with health issues, please consult with doctor before use ; • Patients with a high fever forbid to use this machine. • Perceptual disabilities patients forbid to use this machine. • People over 80 years old forbid to use this machine. • Kids are not allowed to use the chair ; • Don't operate the chair after the use of alcohol. • Please don't sleep in the chair. • Don't use the chair when your body is wet. 	<p>People who are not suitable to use the chair</p>
	<ul style="list-style-type: none"> • Make sure there are no kids or pets or other objects around (under, behind or in front of) the chair at the moment of backrest, leg-rest up/down or leg-rest retraction/extension from reclining position. • During operation, if body is being abnormal, please stop the operation and go consult with your physician. • Please do not take strong massage on the head. • Do not massage belly or knees, be careful when massaging neck. • Children or pets are not allowed to play on the chair especially during massage. Standing or sitting on the back or armrest is not allowed either. • Those who move around with difficulty or can't express themselves must be taken care of strictly and continuously during massage. 	<p>Accident /injury</p>
	<ul style="list-style-type: none"> • Insert the plug of the chair into correct and suitable power socket. • Make sure the plug is completely inserted into the socket to reduce short circuit or fire risk. • Unplug the power when not in use, stop all massage functions and turn off on/off key before unplugging. 	<p>Fire and electric shock</p>
	<ul style="list-style-type: none"> • Massage cushions of the chair are not allowed to fold for storage. • The machine is forbidden for no-load running for a long time. 	<p>Accident</p>
	<ul style="list-style-type: none"> • Power cord, plug, socket can't be used in broken or loose contact condition. • Don't use other electric power except rated voltage in case of fire, electric shock or any breakdown. • Any broken, re-process, knotted, twisted power cord or pressed under heavy cargo is not allowed to use. 	<p>Fire and electric shock</p>





Warning





	<ul style="list-style-type: none"> • If the chair is dysfunctional, or is broken, splashed with water or falls into water, please have it repaired by professional repairman or send the chair to assigned service agent. Self-modification, disassembly or maintenance is forbidden. • If power cord or plug is damaged, please don't replace it yourself, please contact us or appointed dealer for replacement. • To avoid electric shock or body injury, please don't open or disassemble any part of the chair, there is not any attached part of the chair for maintenance by customers. • Check leather or cloth material on the back and other areas is broken or not. If broken, even though it is small, please stop using the chair, unplug the power and have it repaired. 	<p>Disassembly and maintenance</p>
--	--	------------------------------------



Caution

	<ul style="list-style-type: none"> • Please operate the chair when it is flat or on leveled place 	<p>To avoid sudden falling.</p>
	<ul style="list-style-type: none"> • Position the chair 4 inches from the wall to allow for sufficient space to recline up and down. 	<p>To make sure the back lying.</p>
	<ul style="list-style-type: none"> • The maximum suggested operating time is 20 mins. 5 mins for each position beginning with the slight- step massage. Along continuous massage in the same position may cause uncomfortable feeling. 	<p>Too long time massage is bad for your body.</p>
	<ul style="list-style-type: none"> • Before sitting on the chair to avoid injury please inspect everything to confirm that the massage heads are in the correct position. 	<p>To avoid accidental injury.</p>
	<ul style="list-style-type: none"> • Please make sure that the power switch is on "OFF" position before inserting the plug into the socket. 	
	<ul style="list-style-type: none"> • Turn off all controls before removing plug from outlet. 	<p>To avoid the accident when turn on the power.</p>
	<ul style="list-style-type: none"> • Make sure the plug is completely inserted into the socket. 	<p>To reduce short circuits and any fire hazard.</p>
	<ul style="list-style-type: none"> • Checking whether there are any damages on the wire and make sure there are no water or rubbish on the wire. 	
<ul style="list-style-type: none"> • Installing the wire in a correct way. The plug must be inserted into socket with   the connect, the connect couldn't be bent or cut off. 	<p>To avoid electric shock in any leakage or breakdown.</p>	
	<ul style="list-style-type: none"> • Don't use or store the chair in the wet environment like near the swimming pool, or bathroom. • Keep the chair and remote control dry at all time. • Don't use the chair when your body is wet. 	<p>To avoid leakage or electric shock.</p>

Caution

	<ul style="list-style-type: none"> • Don't press with hands or step on the massage heads with feet. • Don't put hands between the working massage heads. Don't put hands or feet in the gap of mechanical parts. Don't drop or insert anything into the slot of massage chair. • Don't stand or sit or put anything on the backrest, armrest, or leg-rest. Don't stand on the chair during operation. Don't move the chair during operation. • Don't pull out the plug or turn off the power during operation. Don't put your hands or head between leg-rest or beneath. Don't use the massage chair while wearing hair ornaments. Don't put hard things in pocket when take buttocks and huckle massage. Don't sit or press on the backrest when the chair is in reclining position. Don't use on bare skin or wearing thin clothes, thin clothes may cause better massage effect, But it also may cause irritation to the skin or cryogenic burns. 	<p>To avoid accidents or injury</p>
	<ul style="list-style-type: none"> • Keep the chair away from heat, wet, sharp things and corrosive, inflammable, explosive environment. • To use electric blanket or other heating products on the chair is forbidden. • Don't put in the space of dust serious or corrosive gas environment. • Don't put the chair in a small space places or use in the bad air circulation places. 	<p>To avoid fade, discolor on upholstery or hardened, deteriorated on PU.</p>
	<ul style="list-style-type: none"> • Keep the chair away from stove or other heating products. • Don't put the chair directly under the sun or other high temperature places. • Don't use the chair in outdoor. 	<p>To avoid electric shock.</p>
	<ul style="list-style-type: none"> • Make sure to install the wire in correct way(Incorrect install way may cause electric shock. If you don't know how to install, please find a professional electrician) • Don't use plug adapter (If the enclosed plug doesn't match with socket, please don't change the plug by yourself and find a professional electrician to install a matched socket.) 	<p>To avoid electric shock.</p>

Caution

	<ul style="list-style-type: none"> • Unplug the power before cleaning the chair. • Unplug the power after using the chair. 	To avoid electric shock or fire hazard.
	<ul style="list-style-type: none"> • Unplug the power when any damage on the power. 	
	<ul style="list-style-type: none"> • Hold the plug to unplug the power but to not try to pull the wire to unplug the power. 	To avoid accidents
	<ul style="list-style-type: none"> • Please turn off the power switch and unplug the power after massage. 	
	<ul style="list-style-type: none"> • Unplug the power immediately when electricity goes off. 	



Warning : 1.Do not use it when gets wet.
 2.The disabled or people who need supervision.
 3.The chair has heat function, people who are insensitive to heat must pay high attention.

| Grounding instruction |

The chair is equipped with a cord having a grounding conductor. The plug must be plugged into an appropriate socket that is properly installed and matched with the plug.



Earth wire is not allowed to be in these places

Gas pipe: probably cause explosion or fire.
 Phone wire and lightning rod: probably cause electric shock and fire when thundering.
 Water pipe: earth wire is useless where there are plastics

PRODUCT COMPONENTS

| Main body diagram (front) |

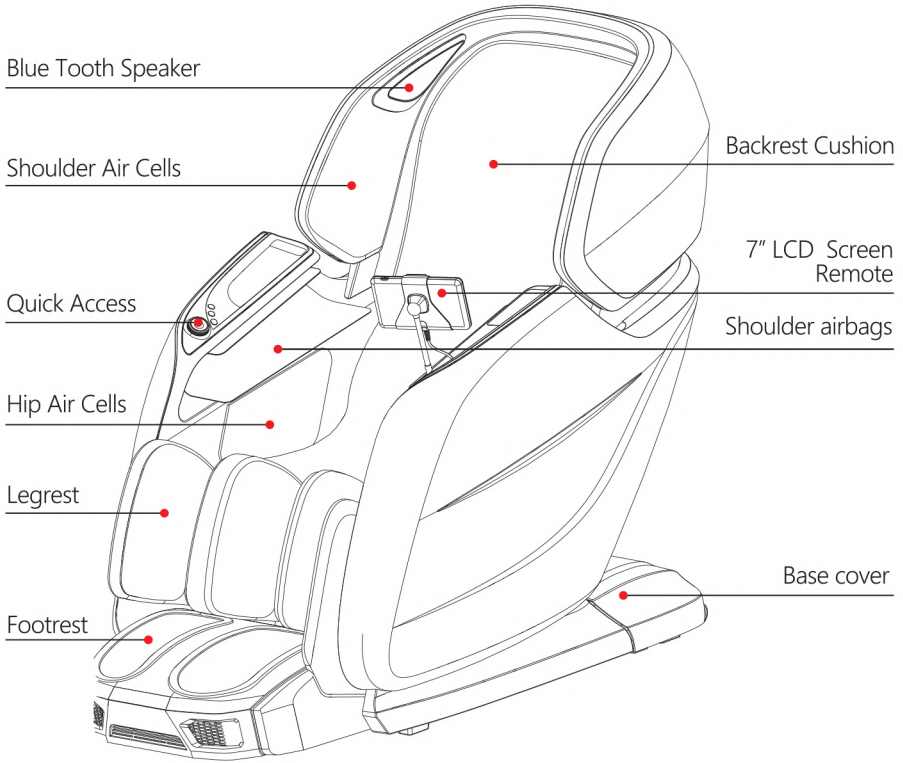

Built in Premium Bluetooth Speakers



| Main body diagram (rear) |

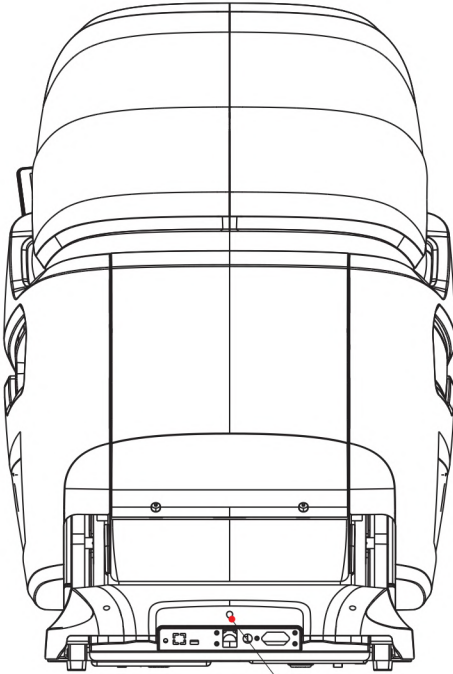

(The Reserve Side)

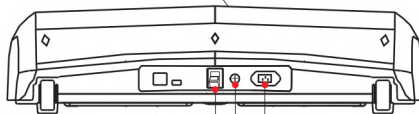

Power Switch

Fuse

Power Inlet

CHAIR INSTALLATION

1. Before use

Use the controller to place the backrest frame to the extreme position, raise the calf to the highest position and raise it to the longest position. Make sure there is sufficient space around the massage chair before operation.

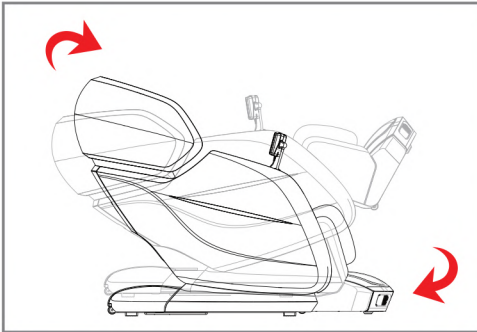

Use the controller to place the backrest frame to the extreme position, raise the calf to the highest position and raise it to the longest position. Make sure there is sufficient space around the massage chair before operation.

2. Moving the massage chair

After completing the installation, put the chair in incline / upright position to move the chair easily.

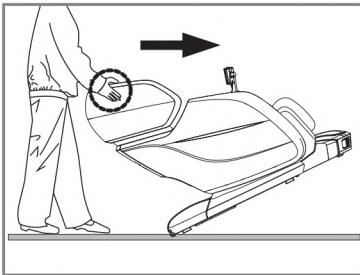

- As illustrated, tilt the chair back onto its wheels at 45° angle. Slowly push and maneuver the massage chair to desired location. Lower massage chair slowly and smoothly until it is fully flat on the ground.

CAUTION

- * Do not move massage chair when occupied or in use.
- * Moving the massage chair may cause damage to the floors. Floor protection is recommended (e.g. rugs or carpet).
- * Do not drop or suddenly let go of the chair when moving as it may damage the chair.
- * Two persons are recommended when moving and extra care when handling the massage chair.
- * Make sure power plug & remote is disconnected to prevent damages. Warranty will not cover the power cord & remote if the chair is moved with the plugs connected.

3. Place the massage chair in an open area |

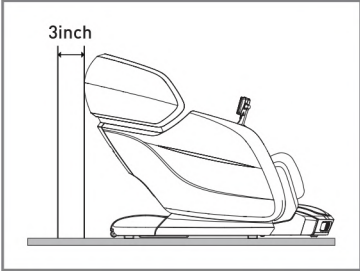

- Allow sufficient space around the chair for recline purposes.
- 3 inch distance for the back side and 19.7 inch in front of the foot rest.



OPERATION GUIDE

Manual Control



1. Turn on LCD SCREEN to start massaging.



2. There are six options on the home page: CLASSIC, SPECIALTY, ELITE TARGET, MANUAL, SETTING, FAVORITES



3. After choosing the CLASSIC mode, there are 8 programs: RENEW, REFRESH, RECOVERY, STRETCH, MORNING, NIGHT, ANTI-STRESS, ENERGIZE

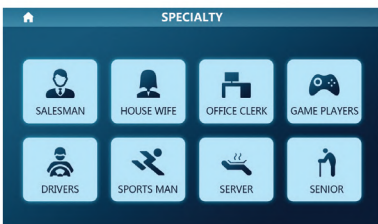

4. After choosing the SPECIALTY mode, there are 8 programs: SALESMAN, HOUSE WIFE, OFFICE CLERK, GAME PLAYER, DRIVER, SPORTS MAN, SERVER, SENIOR.



5. After choosing the ELITE TARGET mode, there are 8 programs: NECK, NECK & SHOULDER, BACK RELIEF, WAIST, WAIST & HIP, LEG FEET, UPPER BODY, LOWER BODY.

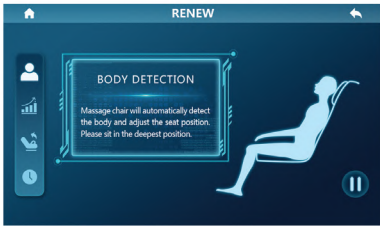

6. After selecting the automatic massage program, the chair will start to body test. For enjoying the most comfortable massage, please put your head on the headrest and try to sit in the deepest of the chair.

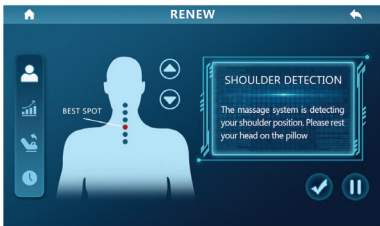

7. After the body test, the shoulder position test will be started, the massage hand will move from top to the shoulder position and start kneading to lock your shoulder position.



8. After choose the CUSTOM mode, it will enter the CUSTOM mode page: In this page, you can select the body parts of the air cells massage, such as the whole body SHOULDER, ARM & HAND, WAIST-HIP, LEG & FOOT massage, or you can select the massage action: like KNEADING, TAPPING, ROLLING, FLAP KNEADING & TAPPING and COMBINATION.



9. In MANUAL mode massage position page, you can control the massage hand position through FIXED POINT, FULL BODY, AREA, UP and DOWN.

In "full body" mode, "up" and "down" are invalid



10. In MANUAL mode OPTIONS page, you can choose the other functions you may need, such as: HEATING, LEG ROLLING, FOOT ROLLING, BLUE TOOTCH, RANGE, WIDTH, MIDDLE and NARROW.

OPERATION GUIDE



11. There are 4 functions: HEATING, LEG ROLLING, AIR MASSAGE and ADD TO FAVORITES. You can add your favorite massage program into ADD TO FAVORITES.

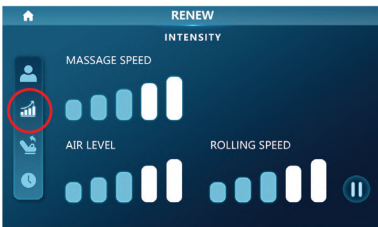

12. This button is to control: CORE POWER, ALL LEVEL and ROLLING FORCE

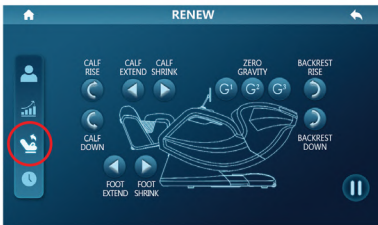

13. This button to help to control: CALF RISE, CALF DOWN, CALF EXTEND, CALF SHRINK, FOOTREST EXTEND, FOOTREST SHRINK, ZERO GRAVITY, BACKREST RISE, BACKREST DOWN.

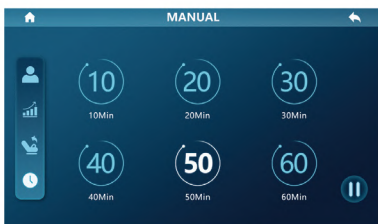

14. This button to change massage time: 10Min, 20Min, 30Min, 40Min, 50Min, 60Min.

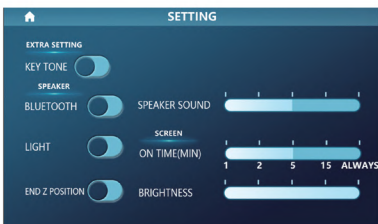

15. Home page SETTING you can control the BLUETOOTH, KEY TONE, DORMANCY, LIGHT, END Z POSITION, BACKLIGHT in setting page.

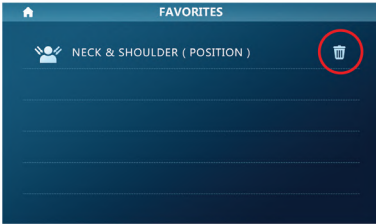

16.FAVORITES:You can add the programs you like into it and when you feel uncomfortable you can delete it.

| key pad |



Open classic mode



Press and hold to control Backrest Down



Press and hold to control Backrest Up



Power on/off

| 3 After use |

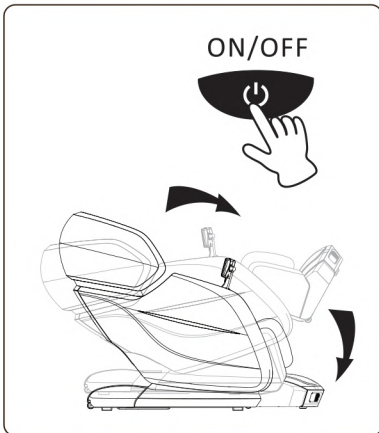

1. After the massage program is completed return the massage chair to upright position by turning off the massage chair.

Please check the surrounding prior to adjust the recline angle, paying special attention to children or pets that may be in close proximity.

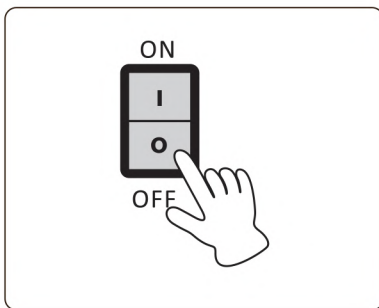

2. Press the power button to power off the massage chair and return remote controller to the storage area on arm pocket.

3. Turn off main power switch when you are not using the chair for a long period of time. Remove Plug from the power outlet to avoid accidents by kids and pets.

4. Do not operate with wet hands.

TROUBLE SHOOTING

If the sounds or movements are not normal, please turn off the massage chair and remove the plug from the electric outlet. Please contact the customer service department for further assistance.

855.646.9500 / 1.714.388.2625, service@kahunachair.com

Problem	Solution
The massage chair is connected to power but is not functioning.	Check to see if the power plug is inserted or if the power outlet is functioning properly.
The remote controller is responding, but the massage chair is not functioning.	The massage chair may have automatically shut down due to overheating protection devices. Please turn off the power and allow the chair to cool off for 30 to 50 minutes.
Both the remote controller and massage chair are not responding.	The massage chair automatically turns into "full stop" mode when a massage program is completed. Please press the power button again to turn of the chair.



KAHUNA CHAIR PRODUCT WARRANTY REGISTRATION
<https://www.kahunachair.com/services/>

MAINTENANCE

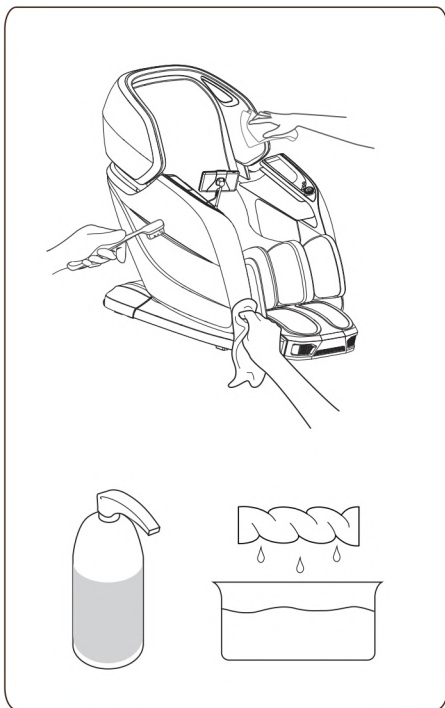

| Use dry cloth to clean |

Turn off and pull out the plug before cleaning the massage chair, do not touch the plug with wet hands.

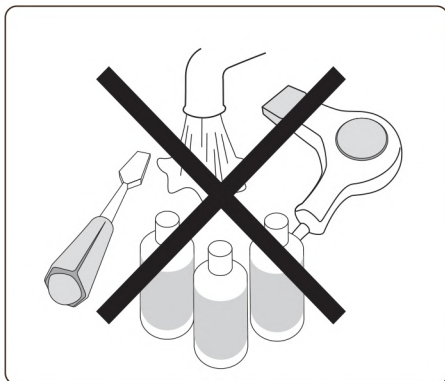

Prohibit using liquid cleaning products like water, alcohol, or other cleaning product to maintain a good quality.

PRODUCT SPECIFICATIONS

Description	Specifications
Product Name	Kahuna Massage Chair
Model No.	EM 8300
Rated Voltage	110-120V~
Rated Frequency	50/60Hz
Rated Power Consumption	200 W
Dimension (LxWxH) Inches	58.27 x 32.88 x 45.67 inches
Weight (LBS)	Net Weight : 286.6 lbs Gross Weight : 319.7 lbs



Product Massage Chair

Model EM 8300

Developed by AJX Distribution INC

11125 Knott Ave, Suite D

Cypress, CA 90630

Tel 1-855-646-9500

Email INFO@KAHUNACHAIR.COM

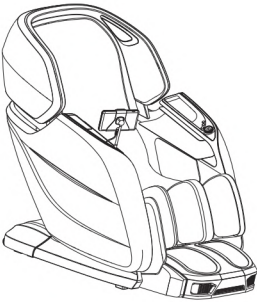

You must register warranty at www.kahunachair.com/services/

INSTRUCTION MANUAL
MODEL:EM 8300

Please read this user manual thoroughly prior to operating the massage chair. Store this booklet for future reference.