



DREAMWAVE



HCP-11001A
HCP-11001D

The World's Best Massage Chair™

Thank you for purchasing the Inada DreamWave.
We hope the Inada DreamWave will be a valued partner in your daily health preservation for many years to come.

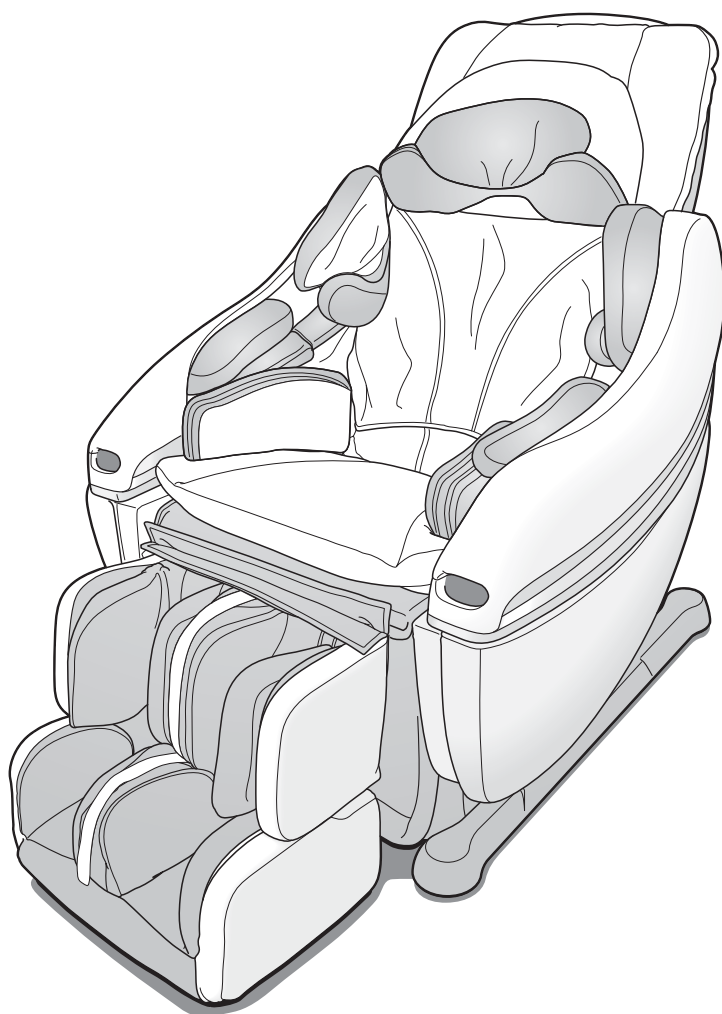

CONTENTS

SAFETY PRECAUTIONS	1
MAIN FEATURES	4
COMPONENTS & DESCRIPTION	5
BEFORE USE	9
POSITION ADJUSTMENT	11
AFTER USE	14
MASSAGE PROGRAMS & SELECTION	15
PRESET PROGRAMS	17
MANUAL SELECTION MODE	19
TROUBLESHOOTING	23
FAQ	26
CARE AND STORAGE	27
CUSTOMER SERVICE AND WARRANTY	28
REGULAR MAINTENANCE FOR SAFETY	29
SPECIFICATIONS	30



Operating Manual
Warranty card provided separately

- Please read this Operating Manual before use.
- Keep this manual nearby so that you can refer to it anytime.
- This product is designed for home use.







SAFETY PRECAUTIONS

Be sure that you have read these SAFETY PRECAUTIONS thoroughly before using your Inada DreamWave for the first time. The Operating Manual contains important information about how to use the chair safely and correctly, avoiding possible damage to property or injury to persons using the chair and others. First of all, you should understand well the meaning of the indications and symbols described below, which are used throughout the Operating Manual to highlight important safety instructions. Please adhere to all precautions. Descriptions of each chair component can be found on pages 5-8.

Types of Indications





 Warning	This action could result in serious injury or death.
 Caution	This action could result in personal injury or damage to property.

Types of Symbols and Description



 Prohibited	Prohibited.	 Do not disassemble	Do not disassemble.
 No wet hands	Do not handle with wet hands.	 Do not wet	Do not use in a location where the chair may become wet.
 Prohibited	Do not use in a bathroom.		
 Required Action	Required action.	 Unplug the chair	Unplug the power plug from the wall outlet.

Remember to keep this Operating Manual in an easily accessible place.



Safety Precautions: Installation

 Caution	
 Prohibited	<ul style="list-style-type: none"> Do not install the chair in an area of high humidity, such as a bathroom or sauna. → Could result in electric shock or damage to the chair.
 Required Action	<ul style="list-style-type: none"> Install on a flat, level surface only. → Chair could tip over accidentally if placed on an uneven surface, resulting in an accident.
 Prohibited	<ul style="list-style-type: none"> Never connect the ground wire to gas pipes, water pipes, telephone lines, or lightning rods.

Safety Precautions: Installation

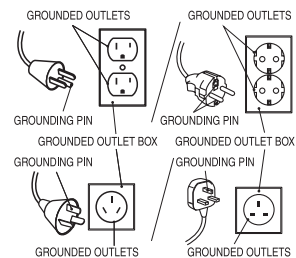
 Warning	
 Electrical grounding	<ul style="list-style-type: none"> Space Requirements This product must be grounded. If it should malfunction or breakdown, grounding provides a path of least resistance for electric current in order to reduce the risk of electric shock. This product is equipped with a cord having an equipment-grounding conductor and a grounding plug. The plug must be plugged into an appropriate outlet that is properly installed and grounded in accordance with all local codes and ordinances. <ul style="list-style-type: none"> Improper connection of the equipment-grounding conductor can result in the risk of electric shock. Check with a qualified electrician or serviceman if you are in doubt as to whether the product is properly grounded. Do not modify the plug provided with the product if it will not fit the outlet; have a proper outlet installed by a qualified electrician. This product uses on a normal Alternating Current(AC) circuit and has a grounding plug that looks like the plug illustrated in the figure to the right. Make sure that the product is connected to an outlet having the same configuration as the plug. No adapter should be used with this product.
 Required Action	<ul style="list-style-type: none"> Always unplug this appliance from the electrical outlet immediately after using and before cleaning.



 Caution	
 Prohibited	<ul style="list-style-type: none"> Do not operate under blanket or pillow. Excessive heating can occur and cause fire, electric shock, or injury to persons. Use this appliance only for its intended use as described in this Operating Manual. Do not use attachments not recommended by the manufacturer. Never operate this appliance if it has a damaged cord or plug, if it is not working properly, if it has been dropped or damaged, or dropped into water. Return the appliance to a service center for examination and repair. Do not carry this appliance by supply cord or use cord as a handle. Never operate the appliance with the air openings blocked. Keep the air openings free of lint, hair, and the like. Never drop or insert any object into any opening. Do not use outdoors. Do not operate where aerosol (spray) products are being used or where oxygen is being administered. Children should be supervised to ensure that they do not play with the appliance.
 Required Action	<ul style="list-style-type: none"> An appliance should never be left unattended when plugged in. Unplug from outlet when not in use, and before putting on or taking off parts. Close supervision is necessary when this appliance is used by, on, or near children, invalids, or disabled persons. Keep the cord away from heated surfaces. To disconnect, turn all controls to the off position, then remove plug from outlet. Keep children away from extended foot support (or other similar parts). Connect this appliance to a properly grounded outlet only. See Grounding Instructions. This appliance is not intended for use by persons (including children) with reduced physical, sensory or mental capabilities, or lack of experience and knowledge, unless they have been given supervision or instruction concerning use of the appliance by a person responsible for their safety.

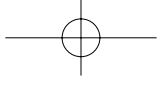

Safety Precautions: Before Use

Warning

 Prohibited	<ul style="list-style-type: none"> ● The following persons must not use this massage chair: <ul style="list-style-type: none"> ○ Persons who have been instructed by a doctor to avoid massage therapy. Ex. Thrombosis, severe aneurism, acute varicosity, or dermatitis and/or skin infection including inflammation of the hypodermis. ○ Persons with suspected acute neck sprain (whiplash injury) ● Do not use a power supply other than the one specified. <ul style="list-style-type: none"> → May result in fire or electric shock. ● Do not use with any type of transformer device. <ul style="list-style-type: none"> → May result in damage to the chair or electric shock. ● Do not use the chair if the power cord or plug is damaged, or if the wall outlet connection is loose. <ul style="list-style-type: none"> → May result in electric shock, short circuit, or combustion. ● Before each use, check for holes or tears in the fabric of the active area. Also, check the other parts for tearing. Unplug the chair and contact your local distributor for assistance. Never use the chair with the fabric of the active area removed or with holes or tears in the fabric, because doing so is extremely dangerous. <ul style="list-style-type: none"> → Using the chair with holes or tears in the fabric could result in injury or electric shock. 	<table border="1"> <thead> <tr> <th>Model number</th> <th>Power supply</th> </tr> </thead> <tbody> <tr> <td>HCP-11001A</td> <td>AC120V~</td> </tr> <tr> <td>HCP-11001D</td> <td>AC220-240V~</td> </tr> </tbody> </table>	Model number	Power supply	HCP-11001A	AC120V~	HCP-11001D	AC220-240V~
Model number	Power supply							
HCP-11001A	AC120V~							
HCP-11001D	AC220-240V~							
 Required Action	<ul style="list-style-type: none"> ● Persons with any of the following conditions should seek medical advice before using the chair: <ul style="list-style-type: none"> ○ Serious heart conditions ○ Sensory impairment caused by serious peripheral circulatory disorders due to diabetes and other diseases ○ Osteoporosis, spinal fractures, acute pain and/or symptoms thereof ○ Persons being treated for personal injuries ○ High fever (38°C (100°F) or higher) Ex. Strong acute inflammation illness caused by fatigue, chills, blood pressure fluctuation, or asthenia ○ Persons in the early stages of pregnancy, or immediately after giving birth ○ Persons who have electronic medical device(s) easily susceptible to electromagnetic interference Ex. pacemaker ○ Abnormal or curved spine ○ Persons planning to use the chair for treatment or for rehabilitation purposes ○ Persons with malignant tumor(s) ○ Persons under bed rest orders ○ Persons with acute gastro-intestinal complaints or ailments such as gastritis, enteritis, or hepatitis ○ Persons under a doctor's care, or those experiencing unusual physical discomfort ○ Joint dysfunction due to rheumatism, gout, or other diseases ○ Persons with symptoms such as qualm, dizziness, or tinnitus ○ Inflammation due to sprains, muscle strain, or other injuries ○ Persons with thecitis or suspected thecitis ○ Persons with thermoanesthesia ● Elderly people and persons with weak bones should seek medical advice before using the chair, even if they do not have a specific disease. ● If your condition does not improve after use, consult a doctor or specialist. 							

SAFETY PRECAUTIONS

Caution

 Prohibited	<ul style="list-style-type: none"> ● Do not use the chair in any way not prescribed by the Operating Manual. Do not use the chair together with any other therapeutic device or with an electric blanket. <ul style="list-style-type: none"> → May result in injury or have a negative effect on health. ● Do not move the chair while someone is in it. <ul style="list-style-type: none"> → Accident or injury may result if the chair tips over. ● Do not sit down on the chair while the seat back is reclined. <ul style="list-style-type: none"> → Any sudden impact on the leg rest could cause damage to the mechanism. Also, an accident or injury may result if the chair tips over. ● Do not use with anything other than the accessories supplied with this product. 	
 Required Action	<ul style="list-style-type: none"> ● Before plugging the power cord into the wall outlet, make sure that the main POWER switch is set to OFF. <ul style="list-style-type: none"> → May result in damage to the chair or electric shock. ● Make sure that the plugs on the power cord are inserted fully into the cord connector and the wall outlet. <ul style="list-style-type: none"> → May result in electric shock, short circuit, or combustion. ● Before using the chair for the first time, turn on all the switches in order as indicated in this Operating Manual to check that the chair is operating properly. ● Start off with a lighter massage. <ul style="list-style-type: none"> → Starting with a deep massage may result in injury. Elderly people and persons with weak bones should be especially careful when selecting massage intensity. ● For safety, first check the position of the mechanism. If the mechanism is not in the storage position, turn the main POWER switch ON and check that the mechanism returns to its storage position before sitting down slowly. For the storage positions, see page 7. ● Do not climb onto, stand on, sit on or otherwise subject the leg rests to a heavy load. <ul style="list-style-type: none"> → Personal injury or damage to the chair may result if the chair tips over. ● If you use the chair after it has not been used for a long time, read this Operating Manual again thoroughly and check if the chair operates properly. 	





Safety Precautions: During Use

Warning



 Prohibited	<ul style="list-style-type: none"> ● Do not wrap the power cord or the remote control cord around the chair, or place the chair on top of either cord. Do not scratch, tear, treat, unduly twist, stretch or bend the power cord or the remote control cord. <ul style="list-style-type: none"> → The cords may be damaged, resulting in fire or electric shock. ● Do not spill water and/or other liquids on the chair or remote control. <ul style="list-style-type: none"> → May result in electric shock, short circuit, or combustion. ● Children should not use the chair. It is advisable to keep children and pets away from the chair (especially from behind the reclining seat back or under the leg rest). Children aged 14 years or over should use only the Youth Program. In such a case, an adult must attend the child. <ul style="list-style-type: none"> → Could result in accident or injury. ● Do not use the chair while more than one person is sitting in it. In particular, do not use the chair while holding a small child (or baby). <ul style="list-style-type: none"> → Could result in accident or injury. ● Do not use the chair while your body is wet, or with wet hands. <ul style="list-style-type: none"> → Could result in electric shock or damage to the chair. ● Do not use the chair if the fabric is torn. If it is, unplug the power plug from the wall outlet. <ul style="list-style-type: none"> → Could result in an accident, injury or electric shock. Contact your local distributor for repairs. ● Do not release your hands suddenly while lifting the chair by hand. ● Do not use the heater continuously for two hours or longer. <ul style="list-style-type: none"> → May result in low-temperature burn. 	
 Required Action	<ul style="list-style-type: none"> ● Make sure no one, especially children or pets, is around the chair before starting a massage program or when lowering or raising the reclining seat back. Be careful that people or objects are not caught behind the seat back or under the leg rest. <ul style="list-style-type: none"> → Could result in accident or injury. ● If a person or object is trapped, press the recline button to return the chair to a safe position. 	

SAFETY PRECAUTIONS





Safety Precautions: During Use

 Caution	
 Prohibited	<ul style="list-style-type: none"> ● Do not use the chair unclothed. ● Do not use the chair for purposes other than massage, or other than the ordinary uses of a chair. → Could result in accident or injury. ● Do not use the chair to massage the head, chest, stomach, and/or joints (knees, elbows). → May result in nausea or injury. Place a soft towel behind your neck if you want to avoid intense stimulation of the area. ● Do not place your hands into the roller tracks, or the moving parts of the reclining seat back or other areas. Do not sit wearing hard objects, such as a hair accessory, necklace, watch, bracelet or ring. → May result in personal injury. ● Do not place your legs anywhere other than the active area (leg mechanism) described in this Operating Manual. ● Do not place anything other than legs and feet on the leg rest. → May result in personal injury. ● Do not place anything other than upper arms and forearms in the Upper-Arm and Forearm Units. Do not place anything other than shoulders against the Shoulder Massage Unit. → May result in personal injury. ● Do not operate the massage chair or leave it operating when there is no one in it. → Could result in accident or injury.
 Required Action	<ul style="list-style-type: none"> ● In an emergency, or if you find any abnormal condition, push the EMERGENCY STOP button on the remote control to stop operation immediately. ● If you get acute pain or other unusual physical discomfort while using the chair, immediately discontinue the use of the chair and seek medical advice. ● If you feel the massage is too strong, reduce the stimulation according to this Operating Manual. If this solution does not work, stop using and contact your local distributor. → May result in injury if you continue use with high stimulation under such circumstances. ● If you feel that the massage is too intense after removing the buffer pad, stop use immediately and reinstall the buffer pad. → May result in personal injury. ● Do not operate a massage without the back pad. ● Do not fall asleep in the chair during a massage session. → May result in personal injury. ● Keep massage sessions to no longer than 30 minutes. Do not exceed 5 minutes for an area-specific massage of any particular part of the body. → Continuous use for extended periods of time can result in over-stimulation, which could cause the opposite of the desired effect, or even injury. Limit the massage time to a total of about 30 minutes in a day. * For children aged 14 years or over, use only the Youth Program and only one session per day. ● If your leg or foot comes out of the leg rest during the massage, do not try to force it back in. → Undue force may result in damage to the mechanism. ● If your arm comes out of the Upper-Arm Unit or Forearm Unit during the massage, do not try to force it back in. → Undue force may result in damage to the mechanism. ● The heater is located under the seat and back of the chair. Person who cannot feel heat should be careful when using the heater.
 Unplug the chair	<ul style="list-style-type: none"> ● If there is a power outage or the possibility of a power outage, stop operation immediately and turn the main POWER switch to OFF. Unplug the power plug from the wall outlet. → Accident or injury may result if the chair is still in operating mode when the power resumes. ● If there is a threat of lightning, stop operation immediately and turn the main POWER switch to OFF. Unplug the power plug from the wall outlet. ● If an operation does not start, or if you find any abnormality, stop the chair immediately and turn the main POWER switch to OFF to prevent an accident. Unplug the power plug from the wall outlet. Contact your local distributor for inspection or repairs. → Electric shock or fire caused by a short circuit may result if the chair is left plugged in under such circumstances.

Safety Precautions: After Use or When Not in Use

 Caution	
 Prohibited	<ul style="list-style-type: none"> ● Be sure to turn the main POWER switch to OFF after every use and to unplug the power plug from the wall outlet. → An accident or injury may result if children or pets play with the chair. ● Do not use a power cord for anything other than the chair. ● After using the chair, be sure to fully return the reclining seat back to the upright position. ● Wipe the chair off after every use, and store the chair in a place with low humidity. ● Do not place any object on the chair.
 Unplug the chair	<ul style="list-style-type: none"> ● Hold the power plug when unplugging from the wall outlet. Do not pull on the power cord. → May result in electric shock or fire caused by short-circuiting. ● Before cleaning the chair, make sure to unplug the power plug from the wall outlet. Do not plug or unplug the power plug with wet hands. ● If the chair is left unused for a while, be sure to unplug it from the wall outlet. → Insulation degradation by dirt or moisture may cause electric shock, or fire due to short-circuit.

Others Precautions

 Warning	
 Prohibited	<ul style="list-style-type: none"> ● Do not stand on the chair. Do not make a major impact or sit on any part of the chair other than the seat. → Personal injury or damage to the chair may result if the chair tips over.
 Do not disassemble	<ul style="list-style-type: none"> ● Do not try to repair any malfunction of the chair. Contact your local distributor for assistance. ● A damaged power cord is dangerous. If the power cord is damaged, contact your local distributor for replacement. ● Do not modify or remodel the chair. → May result in fire, electric shock, or injury.
 Caution	
 Required Action	<ul style="list-style-type: none"> ● If you lend, sell, or otherwise transfer the chair to another party, make sure to include this Operating Manual.

Note

Before disposing of the product or its accessories, consult your local authorities about the proper procedure.

MAIN FEATURES

Main Features

From your palms to the soles of your feet Full-Body Massage Function

Deep relaxation is made possible by modern technologies working together for the Full-Body Massage Function.

The Shoulder Massage Unit and the Upper-Arm and Forearm Units give a gentle massage from your shoulders to your palms.

For massaging of your back, buttocks, and calves, variable massage techniques and unique programming deliver a sensation as close to human hands as you can find. The length of the leg rest can be adjusted by moving the Foot Unit up or down, which enables the leg rest to give a gentle massage to your feet and legs from any angle.

Optical sensors enable the Automatic Shiatsu Point Locator Function

This automatically locates Shiatsu points, which vary from person to person, before starting a massage, allowing for an effective massage that tailors itself to your size and shape.

Easy-to-read massage guide Remote Control Display Panel

The remote control features a clear, easy-to-read display panel that enables you to monitor your massage. The display guides you through each step of your massage, displaying information about each massage action.

Easy to adjust to the most comfortable position Automatic Reclining Function

The seat back can be reclined to any angle between approx. 120° and 165° from the floor. The angle of the leg rest can be adjusted by approx. 90° according to your preference.

With state-of-the-art technology Various Course Functions

Healthcare programs, Well-Being programs, that allow you to select the optimal and Deep Relaxation programs according to your purpose and Manual Selection mode that accommodates your particular needs are provided.

Vibration Massage Function

Vibration mechanisms are located in the seat and chair back. The soothing vibrations add to your sense of calm.

DreamWave Function

The seat rocks approximately 1.6 inches either side of center. The gentle rhythm of the DreamWave promotes thorough relaxation.

Full-Body Stretch Function

The Full-Body Stretch Function is a combination of bending your upper body backward with reclining of the seat back and twisting with the air cushions provided with the seat.

Back 3-D Mechanism

The intensity of massage can be adjusted with an air-actuated 3-D massage mechanism.

Heater Function

The heater located under the seat and back to warm your seat and lower back.

Youth Program Setting

The Youth Program provides a low-stimulation massage for children aged 14 years or over. For this program, the adjustable range of the roller shoulder positions during an Automatic Shiatsu Point Locator operation is extended to cover lower positions, to fit the shoulder positions of young people.

Benefits

As a therapeutic massage device in the general households, the Inada DreamWave provides the following benefits:

- Relaxes muscles
- Relieves minor muscle aches and pains

COMPONENTS & DESCRIPTION

Chair

COMPONENTS
& DESCRIPTION

Shoulder Massage Unit

Back Pad

Upper-Arm Units

Rollers
(Storage roller positions are inside
the upper part of the seat back.)

Armrests

Forearm Units

Seat

Leg Rest

{ **Calf Unit**
Foot Unit

Smart Phone Pocket

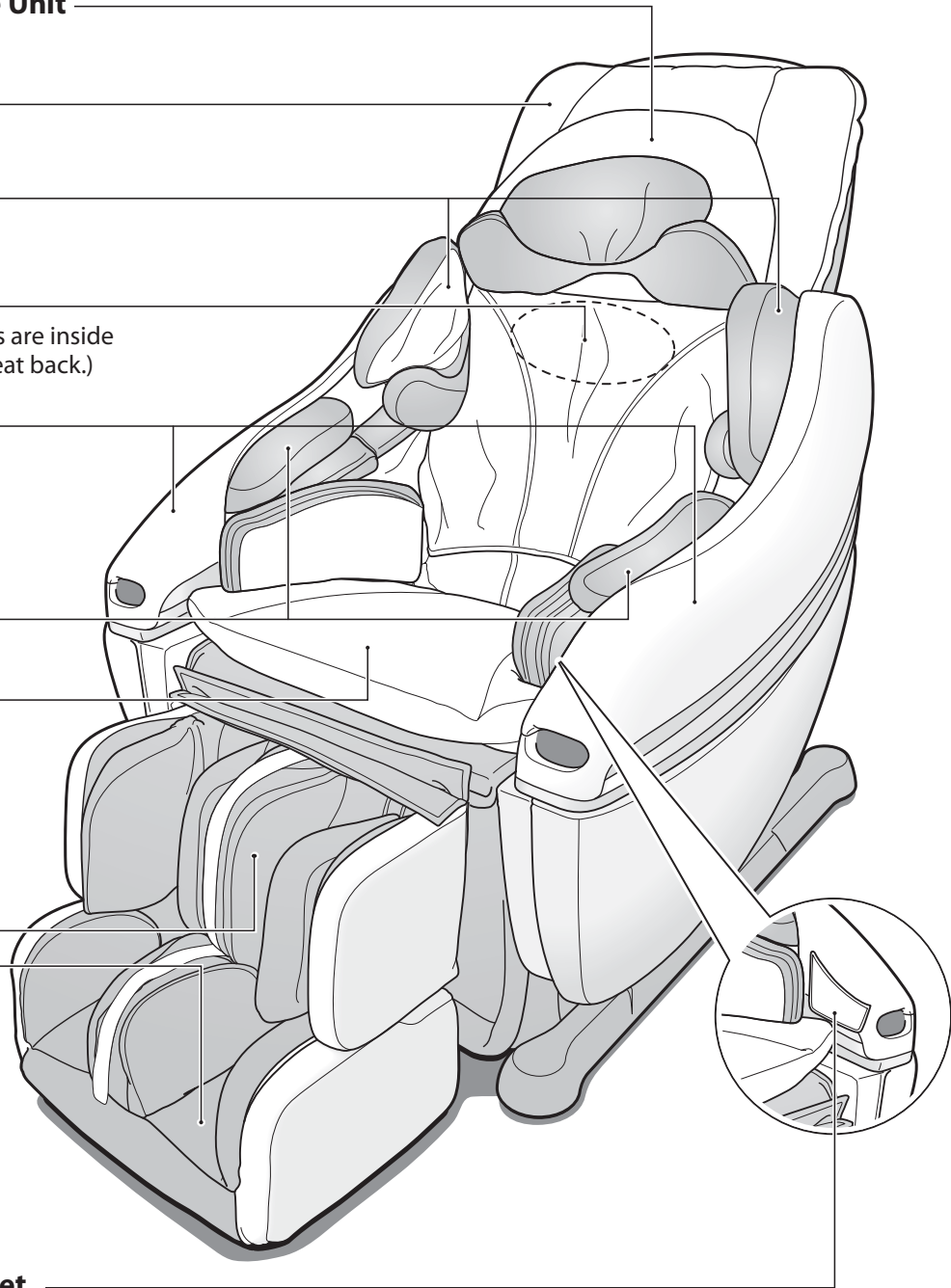

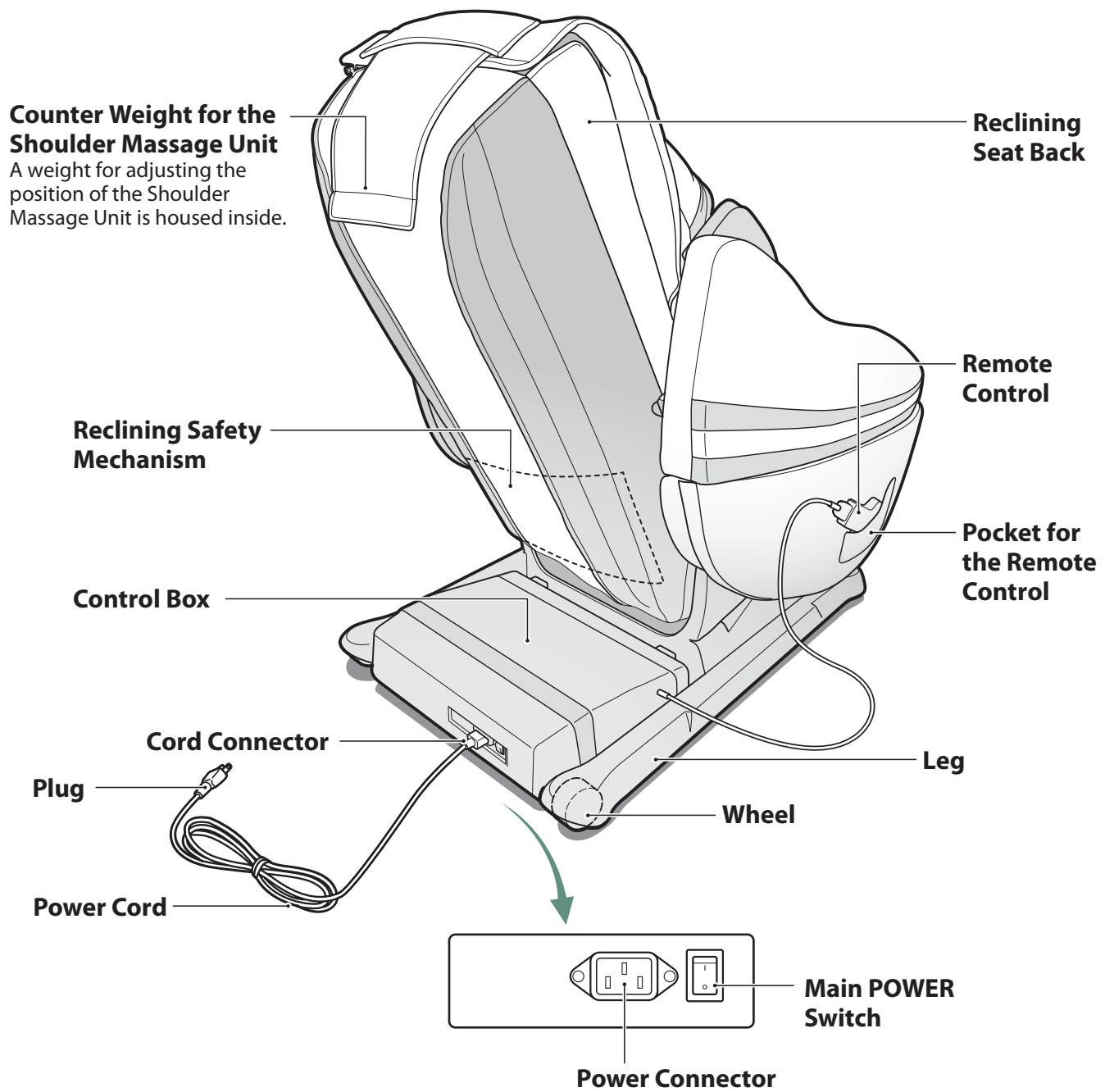

COMPONENTS & DESCRIPTION

Remote Control

COMPONENTS
& DESCRIPTION

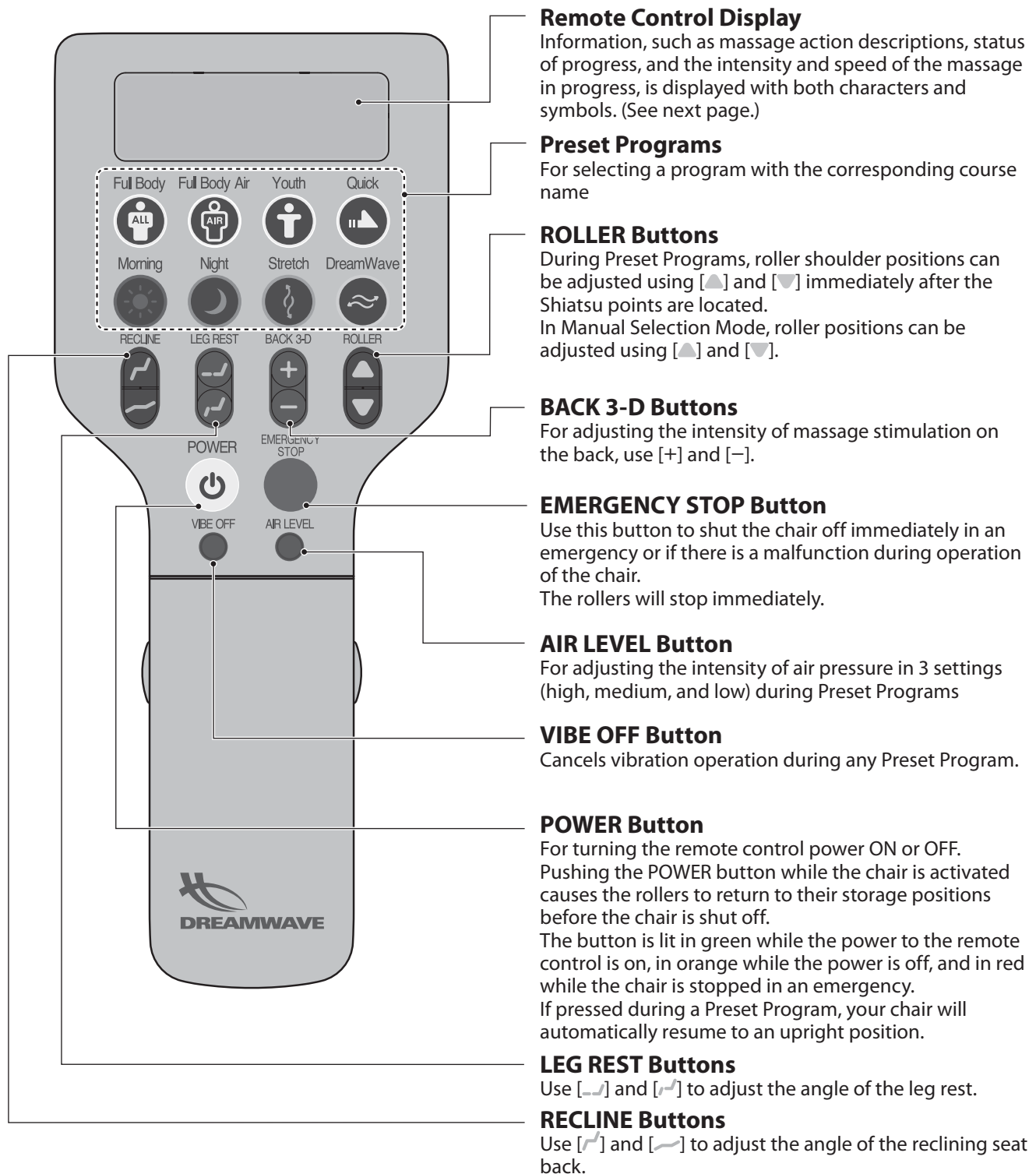

Warning

- Do not spill water and/or other liquids on the remote control.
- Do not handle the remote control with wet hands.

- Do not sit on the remote control. Do not drop or step on the remote control. Do not pull the remote control cord forcibly.
- Do not use pointed or hard objects to push the buttons or display on the remote control.
 - May result in damage to the remote control.

Remote Control Display

Information, such as massage action descriptions, status of progress, and the intensity and speed of the massage in progress, is displayed with both characters and symbols. Characters and symbols on the display move from right to left.

Example: While the Shiatsu Point Locator sensors are being activated, the display shows the following text: "Locating Shiatsu Points..."

Remote Control Display



Remote Control/Inside the Panel

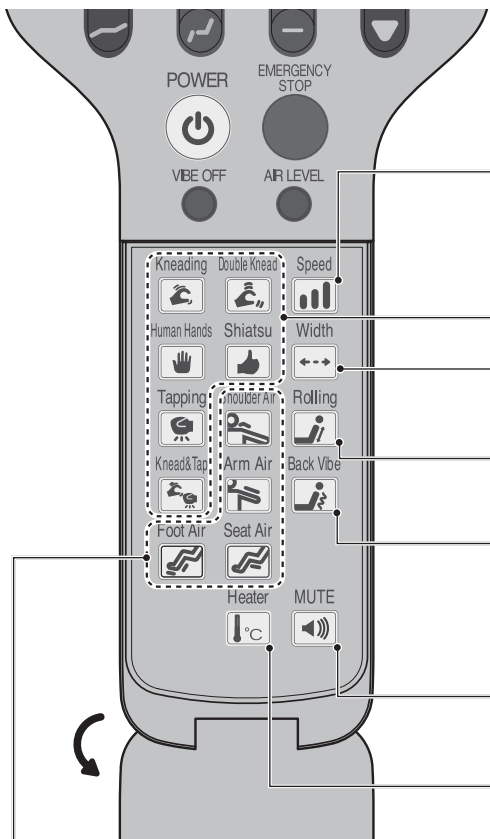

Speed Button

For adjusting the roller speed in three steps during Kneading, Tapping 1, and Kneading & Tapping.

Basic Operation Buttons

Width Button

For adjusting the width of the rollers in three steps.

Rolling Button

You can select from between Full and Partial Rolling.

Back Vibe Button

For back vibration operation.

* The intensity of vibration can be adjusted in two steps (high and low).

MUTE Button

For turning the speaker of the remote control ON or OFF.

Heater Button

For controlling the heat functions in the seat and back.

Air Massage Buttons

You can select from among [Shoulder], [Arm], [Seat], and [Foot].

* The intensity of air massage can be adjusted in three steps (high, medium, and low).

BEFORE USE

- This product is shipped with the reclining seat back in its fully reclined position and with the armrests and leg rest removed. Before use, be sure to attach the armrests and leg rest (refer to the insertion sheet attached) then raise the seat back to its upright position.
- Do not expose the chair to sudden change of heat. If the room where the chair is to be used is cold, turn the heat up slowly. If the chair is moved from a cold place into a heated room, wait one hour before using the chair.
→ Condensation could occur in the moving parts of the product, which may compromise performance.

Installation

Allow for at least 65 cm (26 inch.) clearance behind the chair and 40 cm (16 inch.) in front of the chair when installing, so as to be able to recline the seat back fully without obstruction.

⚠ Caution

- Do not install the chair in an area of high humidity, such as a bathroom or sauna.
- Only install on a flat, level surface.
- Do not use in areas of high debris or dust content. Do not use where ambient temperature is 40°C (104°F) or over.
- Do not install the chair where it can come into contact with direct heat, such as direct sunlight or a radiator.

- To avoid damaging floor surfaces and to cut down on the noise of the chair, it may be better to install the chair on a carpeted surface or to lay a piece of carpet under the chair. (Do not use electric blanket.)
- The product is very heavy, so please be careful when unloading it so as not to damage floor surfaces.
- Install the chair at least 1 m (40 inch.) away from TVs, radios, and/or other audio or video equipment. Interference from these devices can cause problems.
- The load to the floor per 1 cm² (0.16 in²) is approximately 2.5 kg (5.5 lbs.) with a person weighing 100 kg (220 lbs.) sitting on the chair.

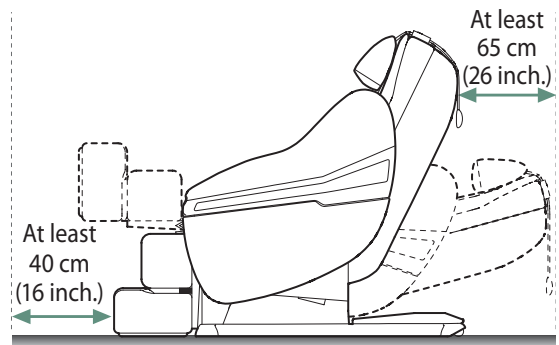

Main Power Connection

- ① Plug the power cord into the cord connector located at the back of the chair first. Then plug the other end into the wall outlet.

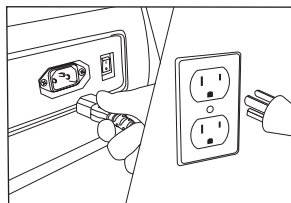

- ② Set the main POWER switch located at the back of the chair to ON. A text message should appear on the remote control display screen.

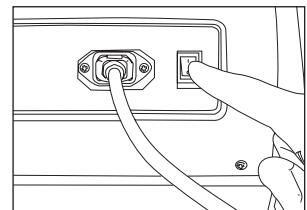

* If the main POWER switch is turned on while the rollers are stopped in the middle of the movement, they will automatically return to their storage position (upper part of the reclining seat) then stop. The seat will also move for adjustment of the initial position then stop.

⚠ Warning

- Do not use with any type of transformer device.
→ May result in damage to the product or electric shock.

⚠ Caution

- Before plugging the power cord into the wall outlet, make sure that the main POWER switch is set to OFF.
- Make sure that the plugs on the power cord are inserted fully into the cord connector and the wall outlet.
- Before using the chair for the first time, turn on all the switches in order as indicated in this manual to check that the chair is operating properly.

Checking the Seat Cover

Check for holes or tears in the back pad and other parts. Check also that the zippers located at both sides of the back pad are securely zipped.

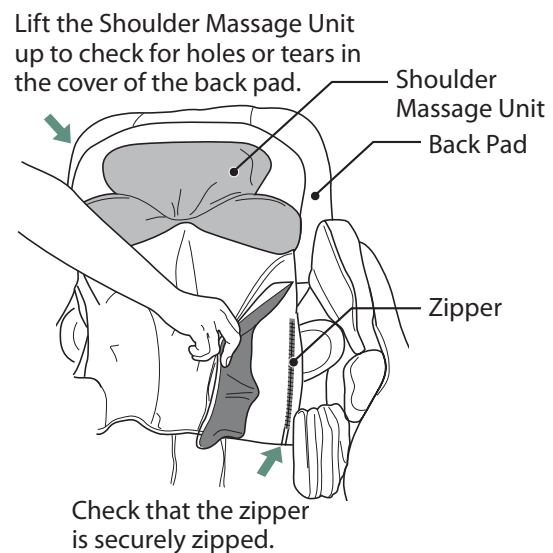

Warning

- Before each use, check for holes or tears in the cover of the back pad. Also, check the other parts for tearing. Stop using the chair immediately if you find even the smallest tear. Unplug the chair and contact your local distributor.

How To Move

First, raise the reclining seat back and set the main POWER switch to OFF. Then unplug the power cord from the outlet. Grip the lower parts of the both armrests, as illustrated, lift the chair, and move.

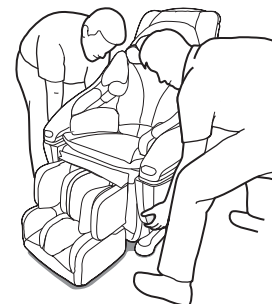

Caution

- Do not move the product while someone is in it.
- During moving, be fully careful not to pinch your feet.

BEFORE USE

POSITION ADJUSTMENT

How to Sit

When the chair is off, the rollers are normally drawn back into the left and right sides of the upper part of the seat back (Storage Position). For safety reasons, first check the positions of the rollers. If they are in any position other than storage positions, set the main POWER switch to ON before sitting down to allow the rollers to return to their storage position. When you finish checking, sit down slowly in the center of the seat.

⚠ Caution

- Do not sit down on the chair with the leg rest raised.
→ Any sudden heavyweight on the leg rest could cause damage to the mechanism. Or, accident or injury may result if the chair tips over.
- Before using, raise the reclining seat back to its fully upright position. Then recline the seat back slowly to the most comfortable position, remembering to start off with a lighter massage.

How to Use the Reclining Seat Back

- **To raise the reclining seat back:** —————
Press and hold the RECLINE [↗] button on the remote control. Release the button when the seat back reaches your desired position.
The button may be released after 2 seconds and the chair will continue to auto-restore to the upright position.
- **To lower the reclining seat back:** —————
Press and hold the RECLINE [↘] button on the remote control. Release the button when the seat back reaches your desired position.
The button may be released after 2 seconds and the chair will continue to auto-recline to the full reclined position.
- The leg rest is raised in conjunction with the movement of the reclining seat back. As soon as reclining of the seat back stops, the leg rest also stops.
- If the main POWER switch at the back of the chair is set to ON, the reclining angle of the seat back can be adjusted.

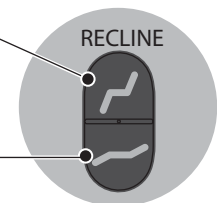

⚠ Warning

- Make sure no one, especially children or pets, is in the way when lowering the reclining seat back. Be careful not to stand or place any object behind the seat.

How to Use the Leg Rest

- **To raise the leg rest:** —————
Press and hold the LEG REST [↗] button on the remote control.
The button may be released after 2 seconds and the leg rest will continue to raise.
- **To lower the leg rest:** —————
Press and hold the LEG REST [↘] button on the remote control.
The button may be released after 2 seconds and the leg rest will continue to lower.
- If the main POWER switch at the back of the chair is set to ON, the angle of the leg rest can be adjusted.

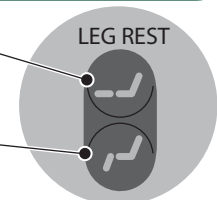

⚠ Warning

- Make sure no one, especially children or pets, is in the way when lowering the leg rest. Be careful that people and/or objects are not caught under the leg rest.
- Do not release hands suddenly while lifting the leg rest by hand.

⚠ Caution

- Do not place anything other than legs and feet on the leg rest.

Foot Slide Adjustment Function

■ How to Move the Foot Unit Downward

To slide the Foot Unit of the leg rest to move it downward, push it down with your feet.

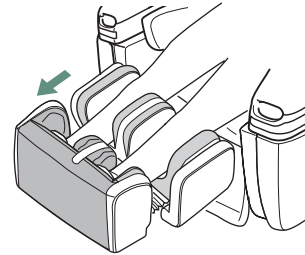

⚠ Warning

- Be careful not to get hands, feet, or objects caught between the leg rest units or between the leg rest and the chair during a foot slide operation.
→ Accident, personal injury, or damage to the chair may result if hands, feet, or objects are caught.

How to Use the Shoulder Massage Unit

Place the Shoulder Massage Unit in a proper position.

If it is not placed properly, the Automatic Shiatsu Point Locator may not function properly.

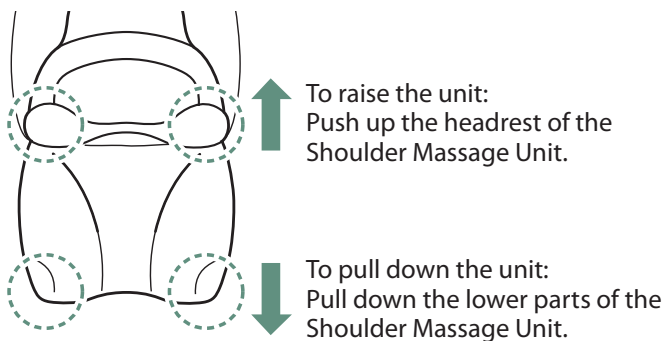

To raise the unit:
Push up the headrest of the
Shoulder Massage Unit.

To pull down the unit:
Pull down the lower parts of the
Shoulder Massage Unit.

Proper Position of the Shoulder Massage Unit

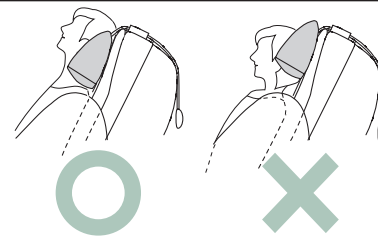

Position both ends of the Shoulder
Massage Unit on your shoulders.

■ How to Use the Chair Without the Shoulder Massage Unit

You can have your shoulders massaged by the rollers and not by the Shoulder Massage Unit, by securing the Shoulder Massage Unit at the upper part of the seat back.

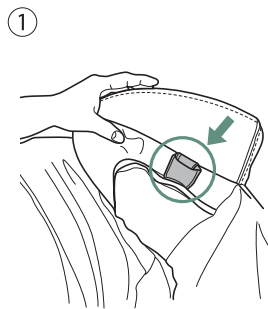

① Flip the side of the Shoulder
Massage Unit over, as
illustrated. The lock belts for
the Shoulder Massage Unit are
initially positioned at the rear
of the Shoulder Massage Unit.

* The lock belts are located at
the both sides of the unit.



② Pull out the belts on both
sides. Move the Shoulder
Massage Unit upward to
the upper part of the seat
back.

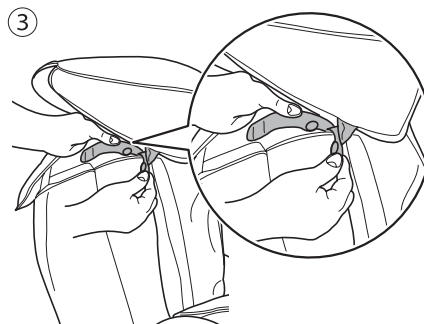

③ Fasten the buttons located at the rear
of the both sides of the back pad to the
holes of the belts.



④ Sit on the chair,
as illustrated, and
start a massage.

POSITION ADJUSTMENT

How to Use the Shiatsu Pads for Shoulders

The Shiatsu Pad for Shoulders (strong) are placed inside the Shoulder Massage Unit.

If you feel that the massage given by the Shoulder Massage Unit is too strong, replace it with the Shiatsu pads (light).

If you feel the massage is too strong, remove the Shiatsu pads.

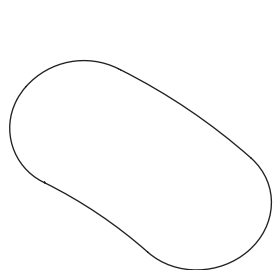

Shiatsu Pad for Shoulders (light)

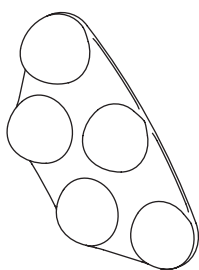

Shiatsu Pad for Shoulders (strong) R

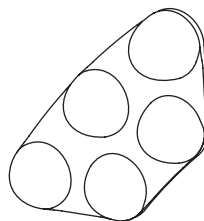

Shiatsu Pad for Shoulders (strong) L

* The Shiatsu Pads for Shoulders (strong) L and R are symmetrical opposites. Use Pad L for the left shoulder and Pad R for the right shoulder.

Disengage the Velcro at the rear of the cover of the shoulder massage section, turn the cover over, then attach the Shiatsu pads at any place where the Velcro is provided, according to your preference.

* For easy replacement of the Shiatsu pads, raise and place the Shoulder Massage Unit at the upper part of the seat back.

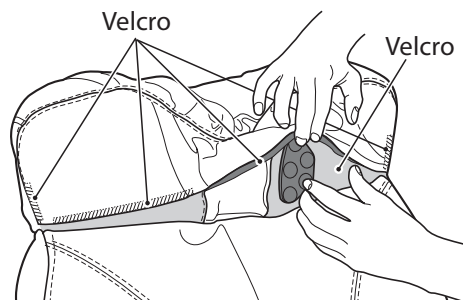

POSITION ADJUSTMENT

How to Install the Massage Buffer Pad (Thin or Thick)

The buffer pad is not required for the use of your massage chair, and this massage chair is shipped from the factory with no buffer pad installed.

If the back massage is too intense, you can add the accessory buffer pad.

Most users find that the addition of a buffer pad is unnecessary, but this is a matter of your personal preference and massage comfort.

If you wish to the buffer pad, please follow the instructions below.

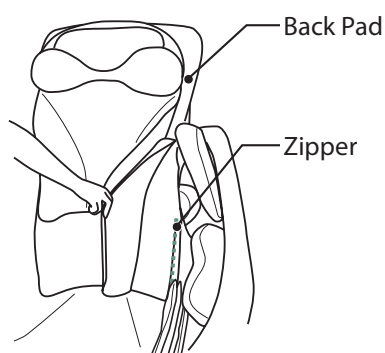

① Unzip the zipper located at one side of the back pad.

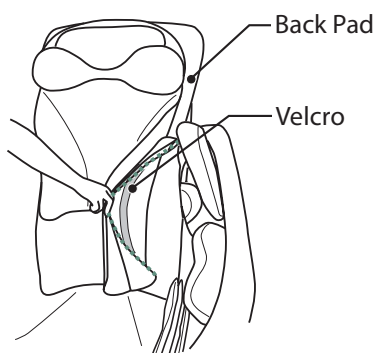

② Disengage the Velcro located at the rear of the back pad.

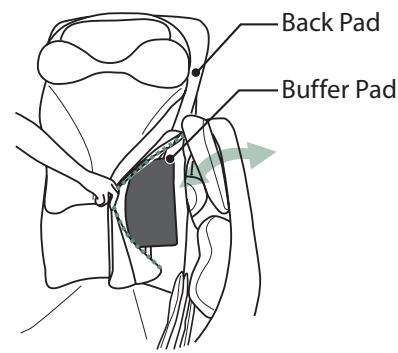

③ Replace the buffer pad.



Caution

● Before use, check that the zippers located at both sides of the back pad are securely zipped.

How to Use the Upper-Arm/Forearm Units

Place your arms in the Upper-Arm and Forearm Units, as illustrated.
Be careful not to place your elbows where the air cushions are.

* Place your arms in the Upper-Arm and Forearm Units with your palm down.

* Be careful not to place your elbows where the air cushions are.

- Do not fall asleep in the chair during a massage.
→ May result in personal injury.
- If you begin to experience marked pain or other unusual physical discomfort while using the product, seek medical advice immediately and discontinue use of the product.

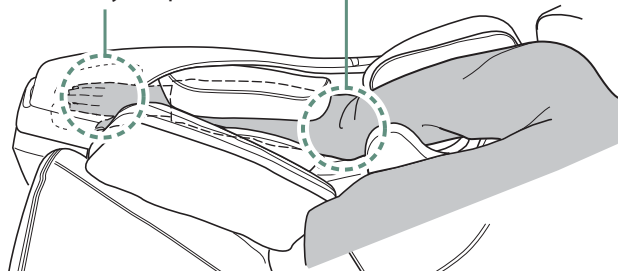

The auto-adaptive width mechanism of the Upper-Arm and Forearm Units enable them to stretch out by 4° at maximum so that they can fit the body type of the user.

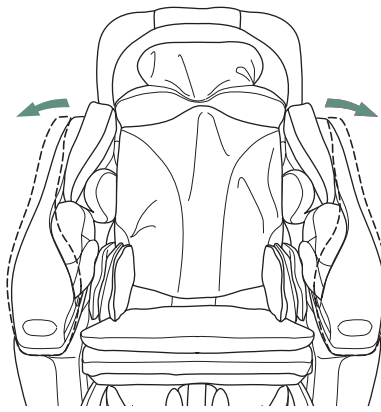

How to Use the Heater

Press the Heater button once to turn on back (b) and seat (s) heat. Press again to activate only the back (b) heat. Press a third time to activate only seat (s) heat.

Pressing a fourth time will turn off all heat.

- The heater turns itself off automatically about 2 hours after it is turned on.
- Without the remote control power on, it is possible to turn the heater on or off if the main POWER switch at the rear of the chair is set to ON.

Button	Indication (b: back, s: seat)

Speaker on the Remote Control

The sound from the speaker can be muted or reactivated with the MUTE button behind the panel of the remote control.

While the sound is muted, the symbol shown on the right is displayed on the display of the remote control.

Button	Indication

AFTER USE

⚠ Caution

- Be sure to set the main POWER switch to OFF after every use and to unplug the chair from the wall outlet.
→ Accident or injury may result if children or pets play with the product.
- After using the chair, be sure to return the reclining seat back to the upright position and lower the leg rest to its lowest position.
- Wipe the product off after every use, and store it in a place free of excess humidity.
- Do not pull on the power cord to unplug the product from the wall outlet; make sure to grasp the plug firmly when unplugging.
- If you will not be using the product for some time, be sure to unplug it from the wall outlet.

MASSAGE PROGRAMS & SELECTION

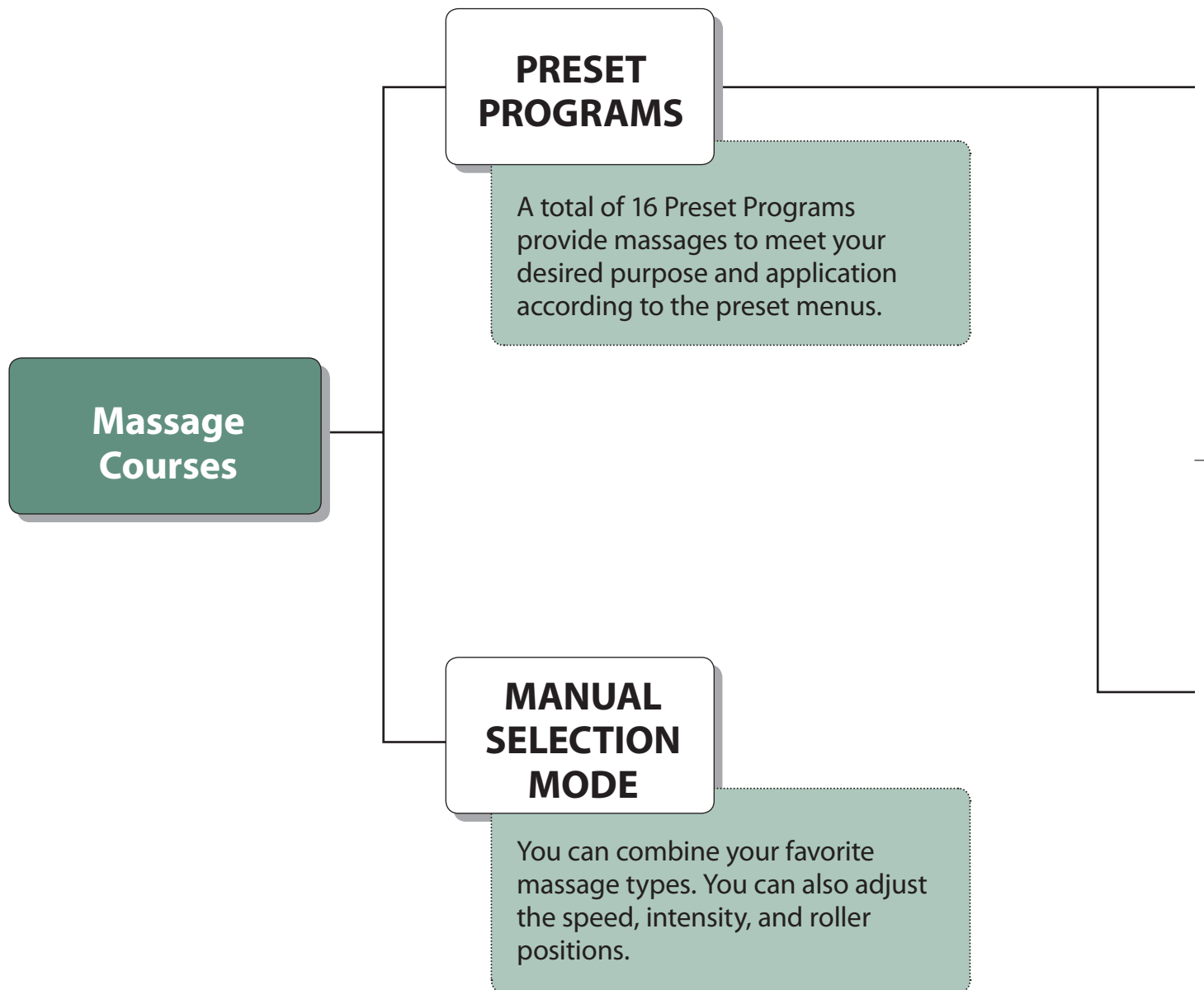

HEALTHCARE PROGRAMS

In order to select the Deep Relaxation version of any of the Healthcare Programs, depress and hold the program button for 2 seconds.

1 Full Body

For a comprehensive full-body Healthcare massage. This program is recommended for persons who feel fatigue or lack of energy.

2 Full Body Air

For a comprehensive full-body massage focused on air massage. This program is recommended for persons who prefer softer massage.

3 Youth

A program for young people. This program is recommended for persons who prefer softer massage or for children aged 14 years or over.

4 Quick

This program provides a quick massage to refresh the entire body.

5 Morning

For morning massage. This program is recommended for persons who have a bad morning or who have not recovered from their fatigue.

6 Night

For night massage. It is recommended to use this before going to bed.

7 Stretch

For stretching operations. This course is focused on curving and twisting motions.

8 DreamWave

For a DreamWave massage. This program is recommended for persons who need relaxation.

● The duration of each course varies depending on height, body type, reclining angle, and other factors related to the user.

WELL-BEING PROGRAMS

In order to select the Deep Relaxation version of any of the Healthcare Programs, depress and hold the program button for 2 seconds.

PRESET PROGRAMS

Preset Programs

- Sixteen automatic programs provide a variety of different massages to relieve fatigue.
- With the Preset Program buttons, you can choose your favorite program, which will provide a carefully crafted massage suited to your needs.

Various Adjustments

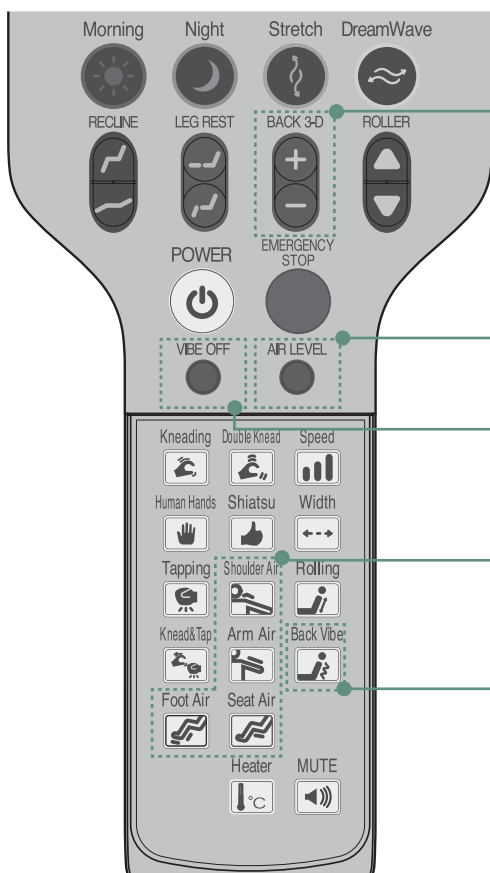

■ BACK 3-D Buttons

The intensity of back massage can be continuously adjusted with [+] and [-].

■ AIR LEVEL Button

The intensity of air massage is initially set to Medium. Each time the button is pressed, the intensity changes in the order of High, air massage canceled, Low, then Medium. (The intensity of air massage for the Youth Program is initially set to Low.)
* If the program is changed, the intensity of air massage is reset to its initial setting (MED).

■ VIBE OFF Button

The vibration function included in a program can be canceled with the VIBE OFF button, according to your preference. To reactivate the vibration function, press the VIBE OFF button again.

■ Air Massage Buttons

The intensity of air massage can be adjusted by area. Each time the button located behind the panel of the remote control is pressed, the intensity changes in the order of High, air massage canceled, Low, then Medium.
* If the program is changed, the intensity of air massage is reset to its initial setting (MED).

■ Back Vibe Button

The intensity of a back vibration operation can be adjusted with the Back Vibe button located behind the panel of the remote control. The intensity of back vibration is initially set to Low. Each time the button is pressed, the intensity changes in the order of High, vibration canceled, and Low.

Changing Courses

Before the course in progress finishes, you can change it to another course. After a total duration of 30 minutes, the course in progress stops even if not completed.

* It may take some time to change courses because the air bags for the BACK 3-D function must be deflated before changing the course.

Switching from One Preset Program in Progress to Another

When one Preset Program button is pressed while another Preset Program is in progress, the rollers return to their storage positions, then the selected program starts after Automatic Shiatsu Point Locator completes a new body scan. You can adjust the shoulder position during Automatic Shiatsu Point Locator operation.

Switching from a Preset Program to Manual Selection Mode

When one of the buttons for Manual Selection Mode is pressed while a Preset Program is in progress, the Preset Program immediately stops, and the selected operation starts. To select an air massage or back vibration operation, press the POWER button to stop the preset program in progress before the selection.

Stopping in the Middle of a Massage

To stop mid-massage, press the POWER button. The rollers will return to their storage positions, a seat will automatically return to the upright position and the massage will stop.

In an emergency or if there is some malfunction during operation of the chair, press the STOP button. The rollers will stop immediately. After confirming safety, press the POWER button. The rollers will return to their storage positions and stop.

⚠ Caution

- If you feel the massage is too strong, reduce the stimulation according to this Operating Manual. If this solution does not work, stop using and contact your local distributor.
→ May result in injury if you continue use with high stimulation under such circumstances.
- Do not place hands or feet into the roller tracks, into the space between the seat back and the seat or into the moving parts. Do not sit wearing hard objects, such as hair accessories, necklace, watch, bracelet, or ring.
- If your leg or foot comes out of the leg rest during the massage, do not try to force it back in.

1 Press the POWER button.
If no selection is made within 2 minutes, the power will automatically shut off.

2 Press the desired button.

- Press and hold the program button for 2 seconds selects the Deep Relaxation version of the massage course.
- If you desire you can combine a sequence of 2 programmed massage courses by following these steps: after selecting your first programmed Massage Course, immediately select your second massage course choice while all the buttons on the remote are flashing. You have about 5 seconds to select your second programmed course. When 2 massage programs have been strung together, the button of the first selected course is glow continuously while the second selected course flashes intermittently. Note: the youth course cannot be part of a combined massage.
- Once a programmed course is selected the chair will automatically reclined to a massage starting position.

3 The ROLLER positions can be adjusted.
With the ROLLER buttons, the vertical position of the rollers can be adjusted. If no adjustment is required, do not use these buttons.

4 The program starts.
The progress of the program is indicated on the display of the remote control with the program name.

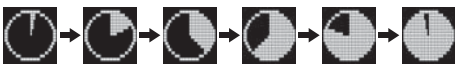

* The progress of the program may not be indicated if the operation is combined with other operations.

5 Program completed.
When the massage program finishes, the rollers return to their storage positions (upper part of the seat back). Then the power to the remote control is shut off. However, reclining of the seat back, angle adjustment of the leg rest, and ON/OFF of the heater are still enabled.

When 2 courses have been combined, at the conclusion of the first selected course, the second selected course commences and the button for the second course changes from flashing intermittently to a steady glow. The second course then commences.

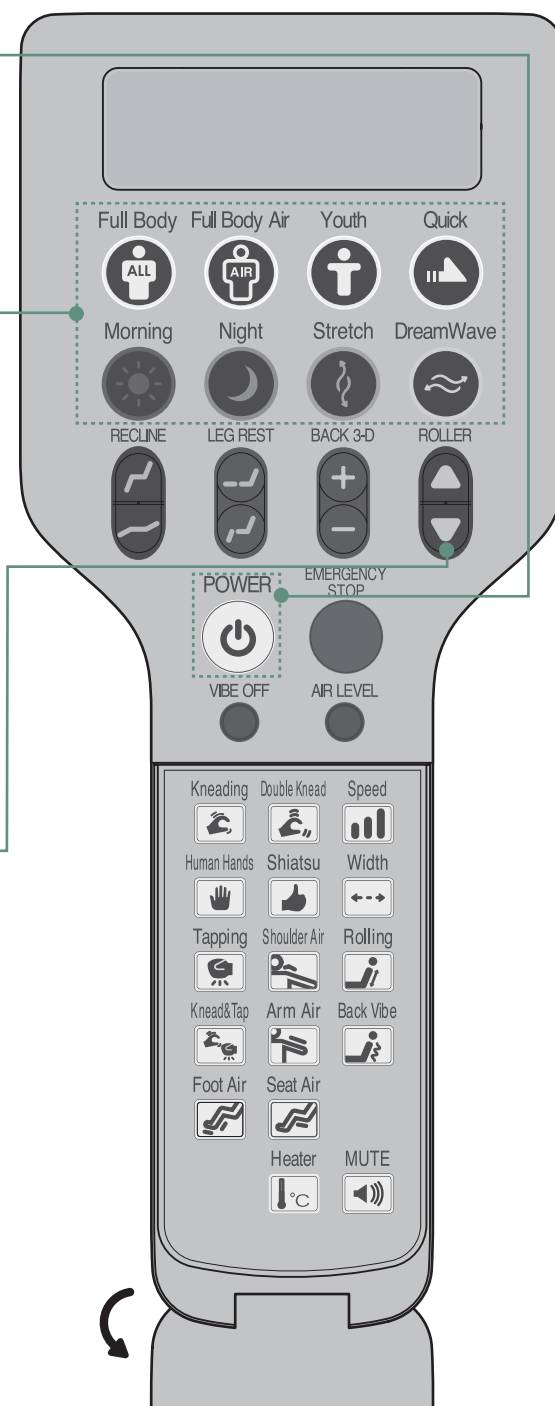

PRESET PROGRAMS

Caution

- Keep massage sessions to no more than 15 minutes in length. Area Specific Massage of any particular area on the body to no more than 5 minutes.
 - Continual use for extended periods of time can result in over-stimulation, which could cause the opposite of the desired effect, or even injury. Set 30 minutes in total for reference per day and keep appropriate intervals between each massage session.
 - * For children aged 14 years or over, use only the Youth Program and only one session per day.

MANUAL SELECTION MODE

How to Operate Manual Selection Mode

You can combine massaging actions of your choice from among menus ① to ④.

- A circle in the adjustment column means that the particular adjustment can be made in the course of that massage action.
- Width adjustment is not available if an action for which width adjustment is not available is combined with rolling or back vibration.
- In the basic and rolling operations, Automatic Shiatsu Point Locator is performed in the same manner as in the Preset Program.

① Basic Operations

- Automatic Shiatsu Point Locator is performed in the same manner as in the Preset Program.
- Once Automatic Shiatsu Point Locator is performed for a basic operation, it will not be performed again if another basic operation is selected.

Operation	Button	Action	Indication	Forward/Reverse	Speed	Width	Up/Down	Intensity
Kneading		This performs kneading type of massage. Each time the button is pressed, forward direction, reverse direction, or stop can be selected. (See page 21.)		○	○ 3 steps	—	○	○
Human Hands		This performs complex massage mimicking the touch of human hands. Each time the button is pressed, forward direction, reverse direction, or stop can be selected. (See page 21.)		○	—	—	○	○
Double Kneading		Kneading in the forward and reverse directions at various speeds will be automatically repeated.		—	—	—	○	○
Tapping		This performs tapping type of massage. Each time the button is pressed, Tapping 1, Tapping 2, or stop can be selected.	Tapping 1		—	○ 3 steps	○	○
			Tapping 2		—	—	○	○
Kneading & Tapping		Kneading and Tapping are simultaneously performed. Each time the button is pressed, forward direction, reverse direction, or stop can be selected. (See page 21.)		○	○ 3 steps	—	○	○
Shiatsu		This performs rhythmical Shiatsu massage. Each time the button is pressed, Shiatsu 1, Shiatsu 2, or stop can be selected.	Shiatsu 1		—	—	○	○
			Shiatsu 2		—	—	—	○



② Air Massage

Each time the button is pressed, Low, Medium, High, or OFF can be selected.

Operation	Button	Indication	Action	Intensity
Shoulders			Air massage to shoulders (The symbol on the left means that the air level to the shoulders is High.)	○
Arms			Air massage to arms (The symbol on the left means that the air level to the arms is Medium.)	○
Leg			Air massage to legs (The symbol on the left means that the air level to the legs is Low.)	○
Seat			Air massage to buttocks (The symbol on the left means that the air level to the buttocks is High.)	○

③ Rolling

Automatic Shiatsu Point Locator is performed in the same manner as in the Preset Program.

Operation	Button	Action	Indication	Width	Up/Down
Rolling		This performs stretching of the full or partial spine with only up and down movements of the rollers. Each time the button is pressed, Full Rolling, Partial Rolling, or stop can be selected.	Full Rolling 		
		Partial Rolling 	<input type="radio"/>	<input type="radio"/> *	



* During Partial Rolling, the center position of the range of Partial Rolling can be adjusted. During Full Rolling, upward or downward movement is reversed.

④ Vibration

This controls the back vibration massage.

(On or Off of vibration operation is automatically repeated at predetermined intervals.)

Each time the button is pressed, Low, High, or OFF can be selected.

Operation	Button	Indication	Width	Up/Down	Intensity
Back Vibration			<input type="radio"/>	<input type="radio"/>	<input type="radio"/>
		Action For a back vibration operation (The above symbol means that the intensity of vibration is High.)			

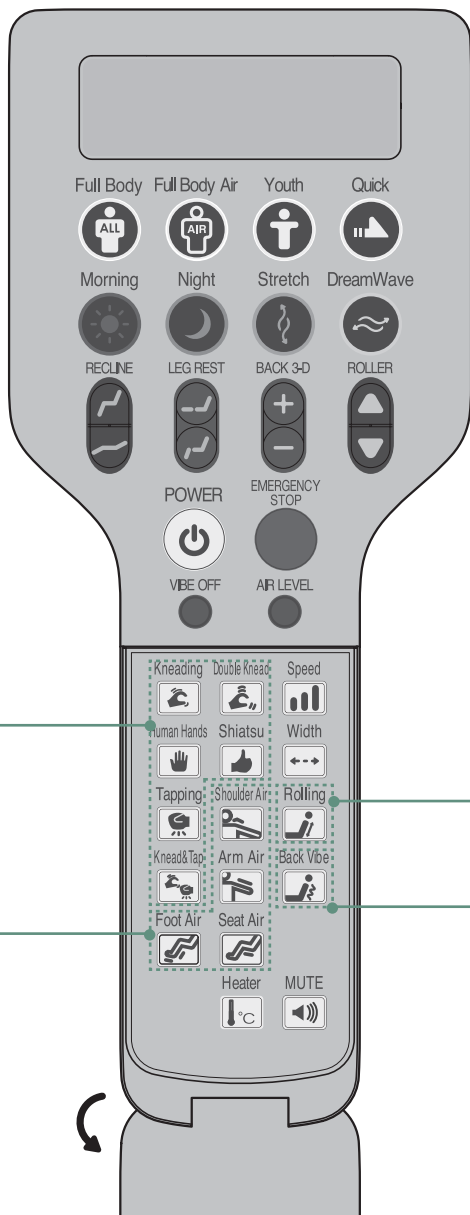

MANUAL SELECTION MODE

Various Adjustments

Change in Forward/Reverse Directions

Operation	Indication	Action
Forward	FWD	During Kneading, Human Hands, and Kneading & Tapping, each time the button is pressed, forward direction, reverse direction, or stop can be selected.
Reverse	REV	

BACK 3-D Buttons

Operation	Button	Action
Intensity		The intensity of back massage can be continuously adjusted with [+] and [-].

ROLLER Buttons

Operation	Button	Action
Up/Down		During Kneading, Human Hands, Double Kneading, Kneading & Tapping, Shiatsu 1/2, Tapping 1/2, and Back Vibration, the roller positions can be adjusted with [▲] and [▼].

* During Partial Rolling, the center position of the range of Partial Rolling can be adjusted. If [▲] or [▼] is pressed during Full Rolling, upward or downward movement is reversed.

Speed Buttons

Operation	Button	Indication	Action
Speed		LO	During Kneading, Kneading & Tapping, or Tapping 1, the speed of action can be adjusted in 3 steps. Speed can be adjusted during operation. The symbol on the left means that the speed is set to Low.

Width Button

During Shiatsu 1, Tapping 1/2, Full Rolling, Partial Rolling, and Back Vibration, the width of the rollers can be adjusted in 3 steps (Narrow, Medium, and Wide). The width can be adjusted during operation.

* Width adjustment is not available if an action for which width adjustment is not available (Kneading, Human Hands, Kneading & Tapping, or Shiatsu 2) is combined with rolling or back vibration.

Operation	Button	Indication
Width	N	
	M	
	W	

MANUAL SELECTION MODE

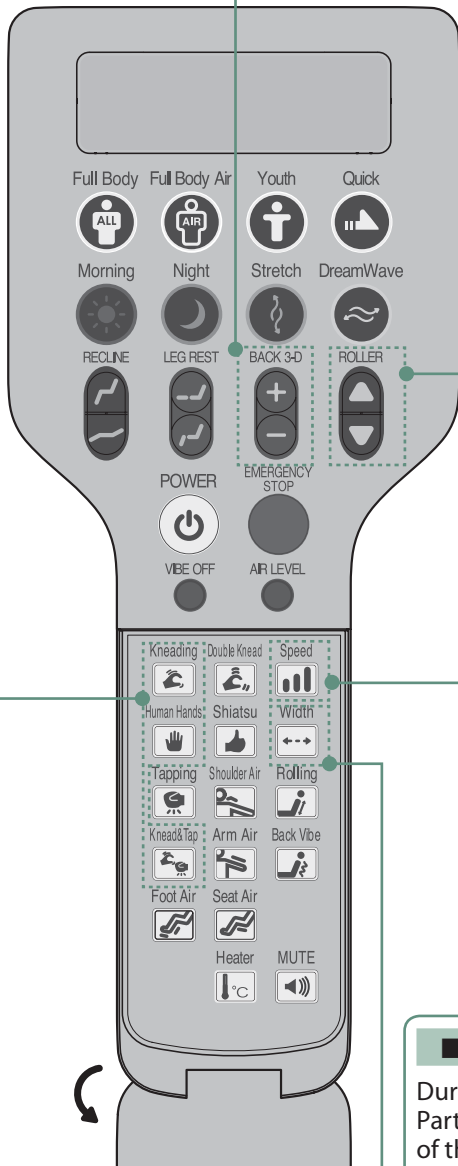

How to Operate Manual Selection Mode

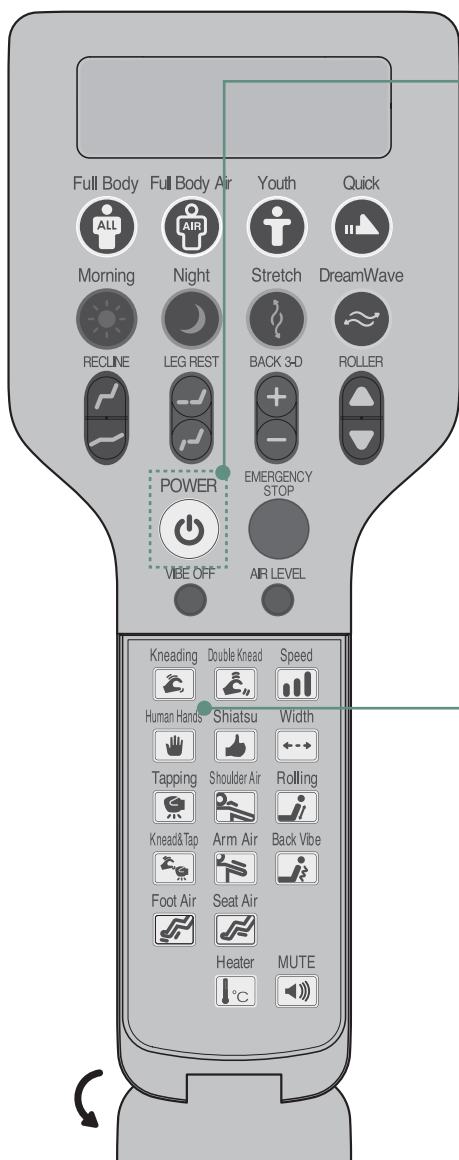

1

Press the POWER button.

If no selection is made within 2 minutes, the power is automatically shut off.

2

Press the desired button.

* Full Rolling, or Partial Rolling is selected, the Automatic Shiatsu Point Locator starts locating Shiatsu points.

3

Massage action starts.

The progress of the course is indicated on the display of the remote control with the course name.

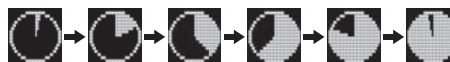

4

After 15 minutes, the massage operation finishes.

The rollers return to their storage positions (upper part of seat back).

Then the power to the remote control is shut off. However, reclining of the seat back, angle adjustment of the leg rest, and ON/OFF of the heater are still enabled.

Changing Courses

Switching from Manual Selection Mode to a Preset Program

- When one Preset Program button is pressed while Manual Selection Program is in progress, the selected preset program starts.
- The roller returns to their storage positions and the new program starts after the Automatic Shiatsu Point Locator completes a body scan. You can adjust the shoulder position during Automatic Shiatsu Point Locator. If a body scan was completed in the manual mode, the Preset Program will commence without conducting a body scan.
- After a total duration of 30 minutes, the course in progress stops even if not completed.

* It may take some time to change courses because the air bags for the BACK 3-D function must be deflated before changing the course.

Stopping in the Middle of a Massage

To stop mid-massage, press the POWER button. The rollers will return to their storage positions, and the seat will automatically return to the full upright position automatically.

In an emergency, or if there is any sudden malfunction, push the STOP button to make the chair stop immediately.

After confirming safety, press the POWER button. The rollers will return to their storage positions, and the seat will automatically return to the full upright position automatically.

Caution

- If you feel the massage is too strong, reduce the stimulation according to this Operating Manual. If this solution does not work, stop using and contact your local distributor.
→ May result in injury if you continue use with high stimulation under such circumstances.
- Do not place hands or feet into the roller tracks, into the space between the seat back and the seat or into the moving parts. Do not sit wearing hard objects, such as hair accessories, necklace, watch, bracelet, or ring.
- If your leg or foot comes out of the leg rest during the massage, do not try to force it back in.

TROUBLESHOOTING

If there is still a problem after trying the solutions given in this troubleshooting guide, stop using the product immediately so as to prevent accident or injury and unplug the product from the wall outlet. For contact your local distributor, please refer to the last page of this booklet.

- Problem** **Noise during operation:**
- During Tapping and Kneading & Tapping
 - Sound of the air pump
 - Sound of rollers rubbing against the seat cover, or squeaky rubbing sound of the seat cover during DreamWave mode
 - Clatter during DreamWave operation
 - Vibrating mechanism noise
 - Sound of the reclining seat back mechanism
 - Sound of the air massage cushions

Cause & Solution These noises are a normal part of the product's operation and do not affect its performance in any way.

Problem **Remote control buttons do not seem to be activating normally.**

- Cause & Solution** Check for the following possible problems:
- ① Check if the power cord is fully plugged into the wall outlet.
 - ② Check if the power cord is fully plugged into the power connector located at the rear of the chair.
 - ③ Check if the main POWER switch at the rear of the chair is set to ON.

Problem **The message "Restart the main POWER switch." appears on the remote control display.**

- Cause & Solution** Set the main POWER switch located at the rear of the chair to OFF then back ON after about 5 seconds.
- ① If the chair returns to normal, no further action is needed.
 - ② If the same message is displayed again, stop using the chair and unplug it from the wall outlet. Contact your local distributor.

Anyone other than an authorized serviceperson must not repair or disassemble.

Problem

The Automatic Shiatsu Point Locator Function is not working properly. (The height of rollers does not fit the shoulders.)

Cause & Solution

Sit further back in the chair so that your head rests firmly on the Shoulder Massage Unit. The roller shoulder positions can be adjusted using the ROLLER buttons immediately after the Shiatsu points are located.

Problem

Massage action stops in the middle of the program.

Cause & Solution

Set the main POWER switch located at the rear of the chair to OFF then back ON after about 5 seconds.

- ① If the chair returns to normal, no further action is needed.
- ② If the chair does not return to normal, stop using the chair and unplug it from the wall outlet. Contact your local distributor.

Problem

The rollers stop during the massage.

Cause & Solution

Sometimes when the speed is slow and there is too much pressure to the rollers, they may stop moving temporarily. This is not breakage. Just slightly lift your body.

Problem

The rollers moved up to the top and then stopped.

Cause & Solution

The auto timer will cause the rollers to move up to the top of the chair when the massage time is finished, so as not to interfere with your movements when getting out of the chair. To continue massaging, press the POWER button on the remote control again.

Problem

The right and left rollers are out of alignment.

Cause & Solution

The rollers are designed to provide for the alternating tapping function, so in the stopped position they are sometimes out of line—

This is part of their design, and there is nothing wrong with the product.

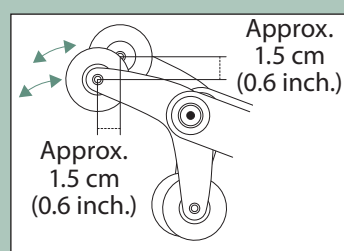

Problem

Reclining of the seat back cannot be performed.

Cause & Solution

Check to be sure there are no objects between the seat back and control box. The reclining safety mechanism may be activated.

TROUBLESHOOTING

Problem

If I try to recline the seat back or adjust the angle of the leg rest during air massage, the chair stops.

Cause & Solution

For safety purposes, the air pressure massage is designed to stop if the reclining seat back or the leg rest is activated. This is not breakage.

Problem

Air massage stops if the [+] button of BACK 3-D is pressed.

Cause & Solution

This is part of their design, and there is nothing wrong with the product.

Problem

Seat Side air cells protrude and do not retract

Cause & Solution

The seat side air cells operate using compressed air inflating a series of air cells that expand like a balloon. Sometimes these air cells do not fully retract on their own. This may happen when the air cells are inflated without a person sitting in the chair or when a very slender person uses the chair. This is easily resolved by gently pressing back the inflated portion of seat side air cells until they rest flat again.

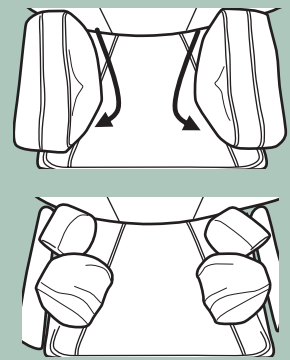

Problem

One of the back massage rollers “snaps” or “skips” sideways when the chair.

Cause & Solution

The back roller mechanism is designed to move side ways in a circular motion. Occasionally, the roller may get caught a wrinkled portion of the fabric. wThis may create a snapping or skipping feeling. Adjust the fabric as needed.

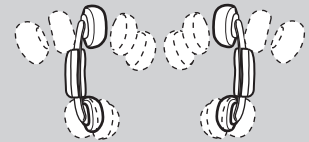

Problem

One of the back massage rollers “jumps” or “skips” vertically

Cause & Solution

The back roller mechanism is designed to move up and down as well as push back and forth. Occasionally, the roller may get caught by a wrinkled portion of the fabric which can create a jumping or skipping feeling on your back. Adjust the fabrics as needed.

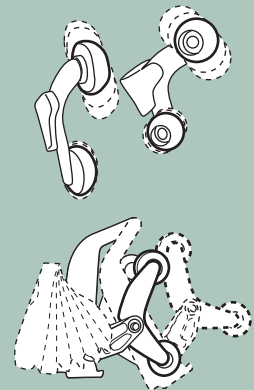

Problem

Heat setting does not seem to be functioning properly

Cause & Solution

The heating elements are located in the center portion of the seat and back. The heating unit is designed to provide a very gentle heat on the seat and back. It does take 5-10 minutes for the heater to reach operating temperature. Pleaes allow adequate time for the seat and back to warm up.

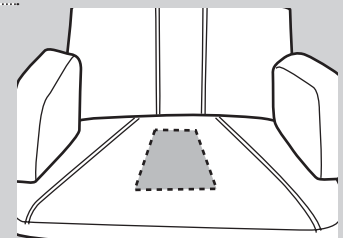

FAQ

Q How do I make the massage deeper?

A During Preset Programs, adjust the intensity of massage with the BACK 3-D, AIR LEVEL, Back Vibe button (behind the panel), or each operation button for air massage (behind the panel) on the remote control. In Manual Selection mode, adjust the intensity of massage with the BACK 3-D, Back Vibe button (behind the panel), or each operation button for air massage (behind the panel) on the remote control.

If this solution does not work, lower the reclining seat back and sink deeply into the chair to put more weight on the reclining seat back.

You can also increase the intensity by removing the buffer pad located at the rear of the back pad.

Q How do I make the massage lighter?

A During Preset Programs, adjust the intensity of massage with the BACK 3-D, AIR LEVEL, Back Vibe button (behind the panel), or each operation button for air massage (behind the panel) on the remote control. In Manual Selection mode, adjust the intensity of massage with the BACK 3-D, Back Vibe button (behind the panel), or each operation button for air massage (behind the panel) on the remote control.

If this solution does not work, replace the buffer pad at the rear of the back pad with the supplied buffer pad (thicker).

You can decrease the intensity of massage by raising the seat back.

Q I spilled water on the product. What should I do?

A Immediately set the main POWER switch located at the rear of the chair to OFF, then unplug the chair from the wall outlet. Contact your local distributor.



CARE AND STORAGE

Storage

- After wiping off any dust or dirt, store the product in a place that is relatively dry.
- If you are not going to use the product for some time, put a cover on it that will protect it from dust and dirt.
- Pets can sometimes chew on power cords, so try to keep pets away from the product even when it is being stored.



Caution

- Do not install the product where it can come into contact with direct heat, such as direct sunlight or a radiator.

Care and Maintenance



Caution

- When cleaning or caring for the product, make sure to unplug the product from the wall outlet first. Do not plug or unplug the power cord with wet hands.

Caring for the Back Pad and Covers

Soak a piece of soft cloth in lukewarm water in which a small amount of mild detergent has been added. Then thoroughly wring it out before cleaning off any spots or grime.



Caution

- The fabric color can change if the product is in contact with vinyl covers or some wall coverings for a prolonged period of time.

Caring for the Remote Control

Wipe dirt off the remote control with a dry cloth.

- Never use a moistened or wet cloth. → May result in mechanical failure.

Caring for Other Plastic Parts

Soak a piece of soft cloth in lukewarm water in which a small amount of mild detergent has been added, thoroughly wring it out, and clean off any spots or grime. Then wipe with a dry cloth so that no detergent residue remains.

- Do not use alcohol based or other household cleaning products or abrasives because they can scratch or crack the finish and/or cause color to fade.

CUSTOMER SERVICE AND WARRANTY

1. Warranty

Please read the contents carefully and keep it in a safe place. Please complete and mail in the warranty card that was include with your chair.

If the chair is to be used outside the home (in a commercial setting, for example), fees will be charged for repairs.

2. Repairs & Service

Before calling for repairs or service, use the Troubleshooting guide on pages 23-25 to see if the problem can be solved easily.

If the problem persists, contact your local distributor. Have the following information ready.

- 1) Your name, address, and phone number
 - 2) Product name and model number (see page 30)
 - 3) Serial No. (see the Serial No. label on the control box of the chair)
 - 4) Date of purchase
 - 5) Trouble status
 - 6) Proof of purchase
- **If the warranty is valid:**
A service charge may apply, subject to the nature of the trouble and/or repair according to the terms of the warranty. See the warranty for full details.
 - **If the warranty has expired:**
See the back of this booklet and contact your local distributor.
If the product can be repaired, we will give you an estimate of the cost to repair the product.
 - **Replacement parts stock:**
We will stock service parts (except fabric) of this product for at least six years after terminating the production of this model.
Service parts refer to those necessary for maintaining the intended performance of the product.
 - **For more information on service:**
Please see the back page of this booklet.

REGULAR MAINTENANCE FOR SAFETY

Regular Maintenance Will Preserve the Life of Your Chair

Have you experienced any of these problems?

- The chair does not start with the main POWER switch set to ON.
- The power cord has been cracked or scratched.
- The power cord or plug becomes abnormally hot.
- The chair produces a burning smell, abnormal sound or vibration.
- The auto timer function does not work in some cases.
- Other failures.

If you find anything listed above, stop using and unplug the power cord from the outlet to prevent failure or accident. Contact us for maintenance.

To Use Safely

Fabric of the chair (roller fabric) is consumable, and its service life is 3 years (conditions of use: two 15-minute sessions a day, every day).

For safe use, periodic inspection by us is recommended before the end of service life.

* Durable years vary depending on conditions of use.

* After about five years of use, a professional inspection is recommended even if there are no symptoms or problems.

For inspection fees, call our technical support number.

SPECIFICATIONS

Model Number	HCP-11001A	HCP-11001D
Power Supply	AC 120 V	AC 220-240 V
Power Consumption	208 W (Power consumption of the heater only: 5 W)	
Power Frequency	60 Hz	50-60 Hz
Rated Time	30 minutes	
Upper Body	Kneading Speed	3 levels, from minimum approx. 9 times/minute to maximum approx. 32 times/minute
	Tapping Speed	3 levels, from minimum approx. 190 times/minute to maximum approx. 480 times/minute
	Roller Width	3 levels Narrow, Medium, and Wide
	Up/Down Speed	Minimum approx. 3.1 cm (1.22 inch.)/sec, maximum approx. 4.2 cm (1.65 inch.)/sec
	Back Stroke Range	Approx. 72 cm (28 inch.) (in partial rolling massage: approx. 15 cm (6 inch.))
DreamWave Operation Speed	Minimum approx. 11 times/minute, maximum approx. 24 times/minute	
Preset Programs	Healthcare Programs: 4 types, Well-Being Programs: 4 types	
Manual Selection Mode	15 types (Automatic Shiatsu Point Locator Function included in some programs)	
Vibration Massage Function	Back: 2 levels (Min: Approx. 1975 times/minute, Max: Approx. 2925 times/minute) Seat: 1 step (Min: Approx. 1840 times/minute, Max: Approx. 4170 times/minute)	
Air Pressure	60 Hz: Approx. 38 kPa	
Auto Timer	Approx. 15 minutes (Preset Programs vary in duration.)	
Heater	Outer cover temperature: 39°C (102°F) or less (at the ambient temperature of 25°C (77°F)), Timer: Approx. 2 hours	
Leg Rest Adjustment Range	Approx. 25 cm (10 inch.)	
Reclining Angle	Approx. 120°-165° from floor level continuous motion (Automatic reclining)	
Dimensions	Approx. 93 (97) × 139 (210) × 121 (76) cm (W/D/H) (Approx. 37 (38) × 55 (83) × 48 (30) inch. (W/D/H)) The figure in () for the width represents the dimension when the armrests are fully extended. The figures in () for the depth and height represent dimensions when the seat back is fully reclined and with the leg rest flat.	
Weight	Approx. 115 kg (253 lbs.) (Chair: Approx. 75 kg (165 lbs.), Arm rests: Approx. 22 kg (48 lbs.) [one unit 11 kg (24 lbs.) × 2], Leg rest: Approx. 18 kg (40 lbs.))	
Outer Covering	Synthetic leather (with antibacterial/dirt resistant finish)	
Accessories	Power Cord, T-shaped Wrench, Buffer Pad (thick), Buffer Pad (thin), Shiatsu Pads for Shoulders (light) (1 each left and right), Shiatsu Pads for Shoulders (strong) (1 each left and right)	



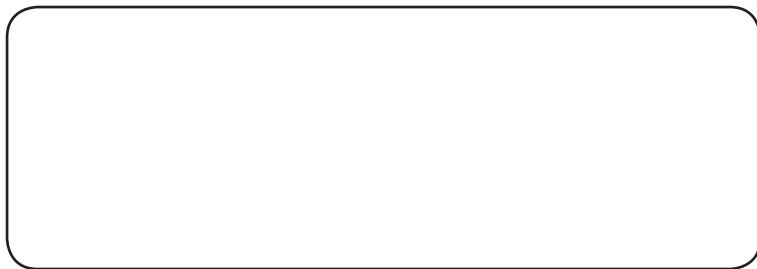

Manufactured by FAMILY INADA CO., LTD.

DATE OF ISSUE (day/mo/yr)
1/5/2014
Made in Japan
778612000