



**HIGH ENERGY
ALTERNATOR REGULATOR**
Installation Guide v1.2





NOTIFICATIONS



FOR SYSTEMS THAT UTILIZE A NEGATIVE DISCONNECT ON THEIR BATTERY.

You must disconnect the Battery/Control Harness from Zeus before any maintenance is performed on the system. Only re-connect the harness to Zeus once the ground and power connections have been re-energized.



ARCO ZEUS ALTERNATOR REGULATOR

Installation Guide v1.2

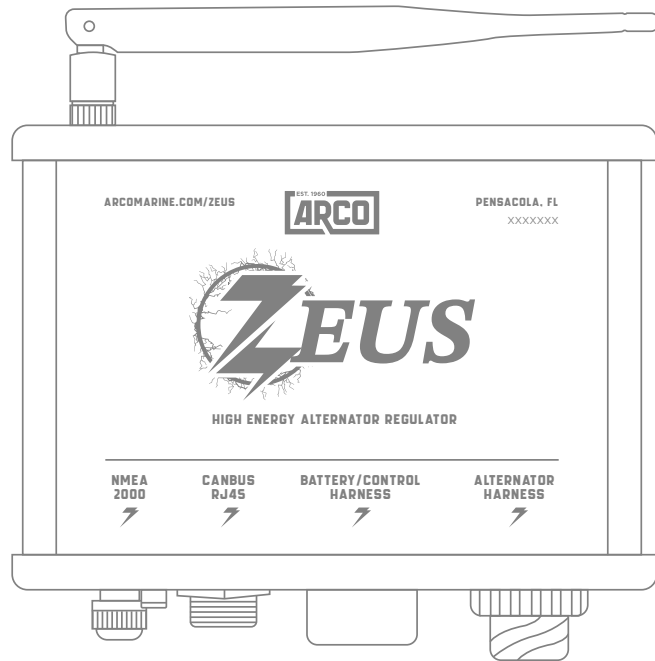

ARCO’s Zeus is the only high-energy alternator regulator to feature Bluetooth and a native app (on IOS and Android) allowing for easy installation and configuration. With its intuitive interface, you have access to information on your system that you never had before. This information allows you to regulate your system and optimize your battery charge and alternator output resulting in a safer experience while protecting your energy system investment. Through the ARCO Zeus application, you are in good hands as your data can be logged and then shared with your technician to troubleshoot system problems when remote.

Zeus optimizes battery charges for 12-48 volt systems. Whether you are using Lithium (LiFePo4) batteries to lead-acid Deep Cycle batteries, Zeus has you covered with its pre-set battery libraries and configurable menus to optimize your charging profiles. Zeus manages a complex set of inputs by giving you easy-to-understand options.

Zeus also takes into consideration the power of your engine and allows you to configure the alternator’s power take off from the engine by managing the field, or duty. An advanced feature of Zeus is that it can turn your engine into a dedicated generator with a press of the button, whereby it focuses the alternator’s performance to the creation of energy in replenishing your battery bank quickly.

Consistent with Zeus’s ease of use, Zeus is the only alternator regulator on the market that comes with alternator/battery harnesses and 2 thermistor harnesses, without an additional charge, saving users money and time from sourcing harnesses.

TABLE OF CONTENTS

What’s Included in the Zeus Package.	2
Tools You Will Need	3
Installation and Configuration Process.	4
Shunt Placement Guide	10

WHAT'S INCLUDED

Installation Guide v1.2

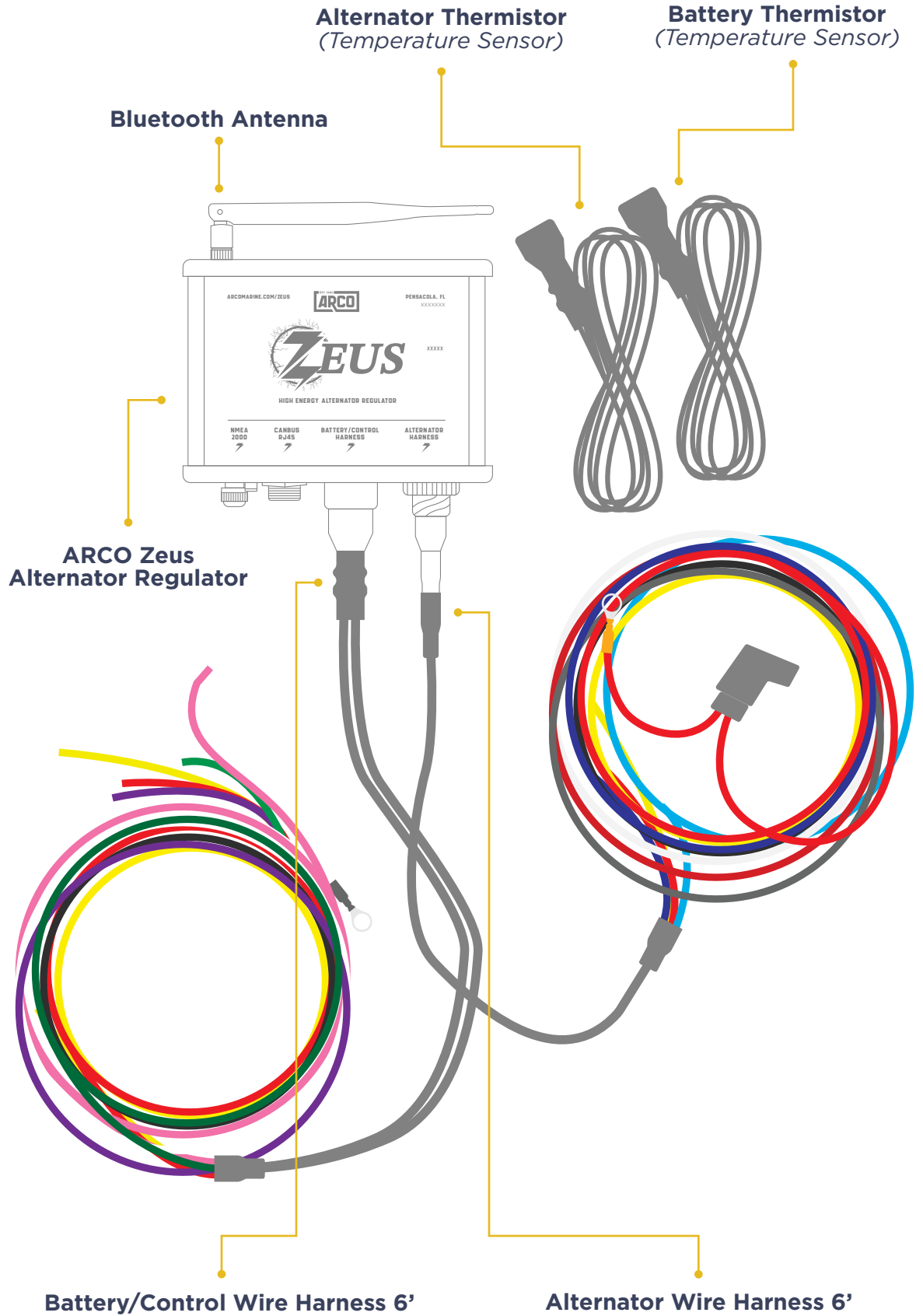

WELCOME

Installation Guide v1.2



VISIT [ARCOMARINE.COM/ZEUS](https://arcomarine.com/zeus) TO
DOWNLOAD THE APP FOR IOS AND
ANDROID. FOLLOW PROMPTS IN THE
APP FOR EASY GUIDE INSTALLATION.

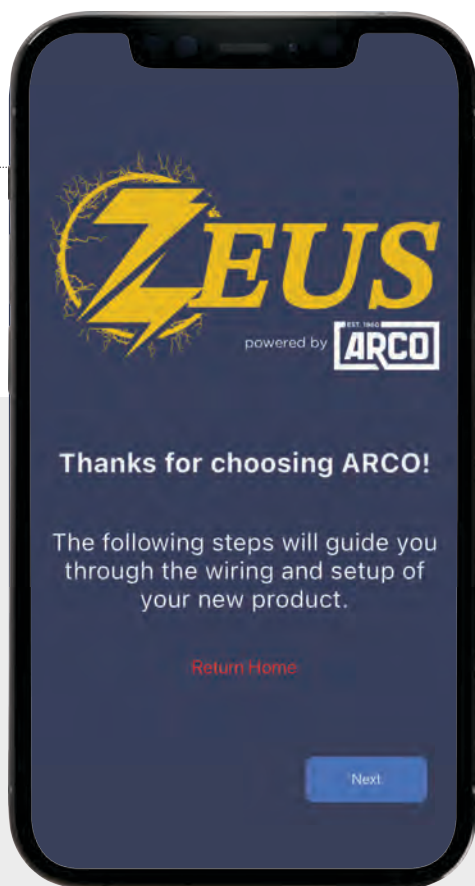

CLICK HERE
to begin the installation
and configuration
process for your
regulator

INSTALLATION

Installation Guide v1.2

CLICK NEXT
to continue.

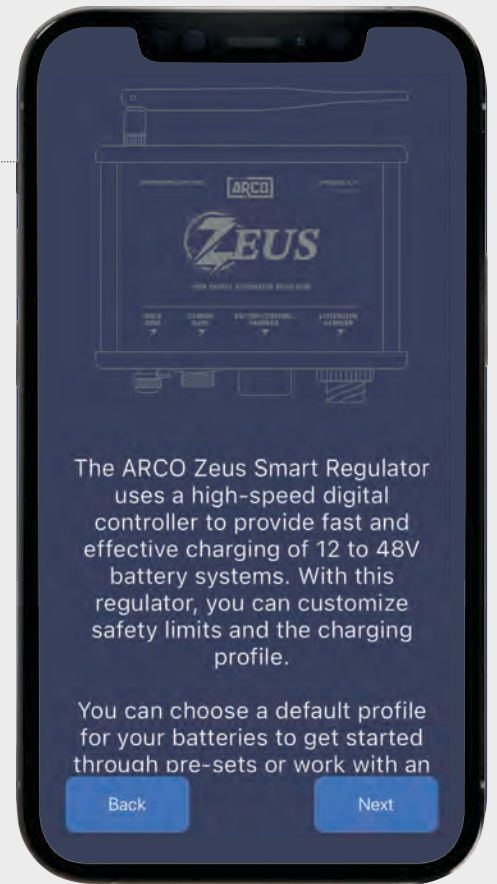

The ARCO Zeus Smart Regulator uses a high-speed digital controller to provide fast and effective charging of 12 to 48V battery systems. With this regulator, you can customize safety limits and the charging profile.

You can choose a default profile for your batteries to get started through pre-sets or work with an

Back

Next



The ARCO Zeus can cause catastrophic damage to persons and equipment. Always pay attention to written warning and symbols.

Back

Next

Because you are working with electricity, always pay attention to the warning symbols in this guide.



CLICK NEXT
to continue.

MAXIMIZE YOUR ARCO ZEUS REGULATOR by monitoring your Batteries AND your Alternator.

You have a decision to make:

- A)** Have the regulator turn on and off with the battery switch (*ARCO Zeus Regulator load is less than 10 milliamps in Standby*), or
- B)** Hardwire the Regulator to the batteries*

***Q:** Why would I hardwire the Regulator to the batteries?

A: To take advantage of using the ARCO Zeus as a State of Charge Meter! Yes, you can easily do that with a shunt sold separately.

Starting With Your Alternator:

- 1** Install the Alternator Thermistor (*included*) here:

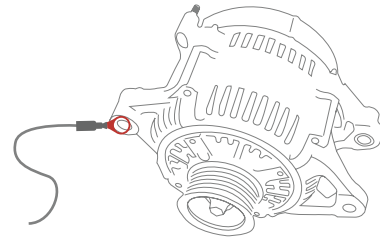

- 2** Install the Alternator Shunt (*sold separately*) here:

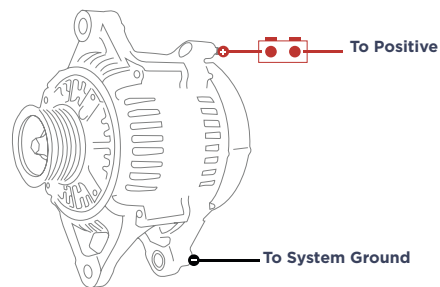

Moving On To Your Battery:

- 3** Install the Battery Thermistor (*included*) here:

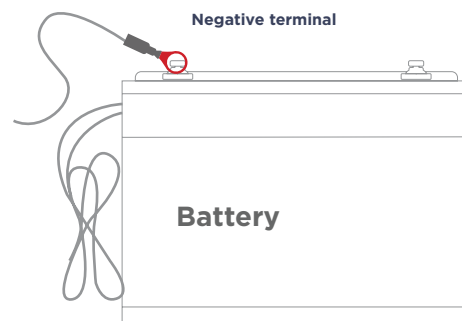



FOR STATE OF CHARGE, THE SHUNTS MUST BE CONNECTED. SUGGESTION ON SHUNT PLACEMENT.

Negative side shunt:

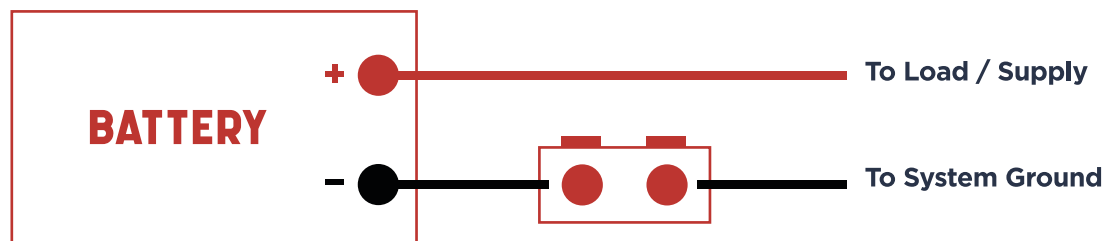

Positive side shunts are typically used with case ground alternators.

Positive side shunt:

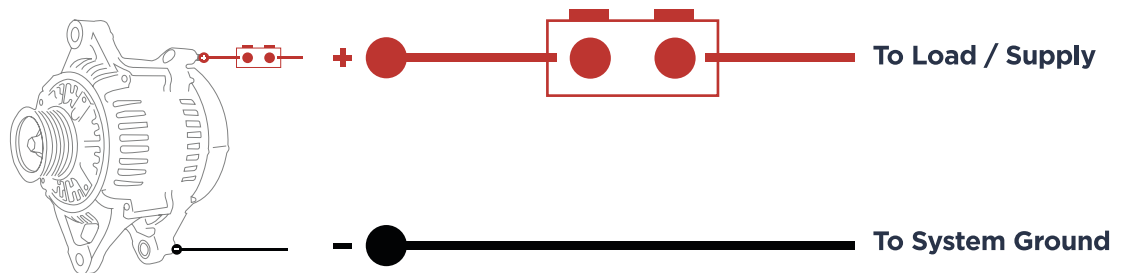

CONGRATULATIONS!

You have set up measuring instruments on the only Regulator that monitors 1) *BOTH* Batteries and Alternator inputs *AND* 2) can measure State of Charge (SOC).

Before you begin the installation process, you will need to gather information, turn off your power and plan placements of your regulator and accessories.

CLICK NEXT
to continue.

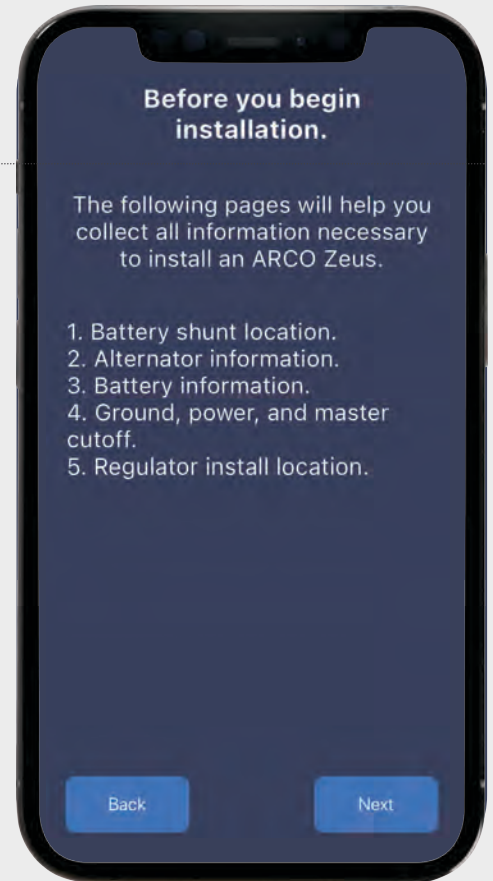

Locate your battery ground shunt.

A battery shunt is **REQUIRED** to use an ARCO Zeus. If your system does not have a shunt please install one before continuing.

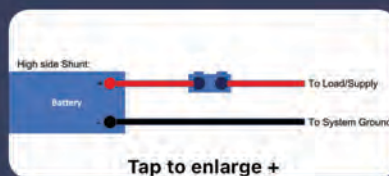

Back

Next

A battery shunt is required to observe current limitations for the battery bank in addition to the use of the onboard battery monitor.

The preferred method is to have the shunt on the negative side. If a positive side shunt is the only option available, an appropriately sized fuse must be installed immediately after the batteries prior to the shunt.



CLICK NEXT
to continue.

You will need information on your alternator. You will be able to find your alternator details through their website or contacting the manufacturer.

CLICK NEXT
to continue.

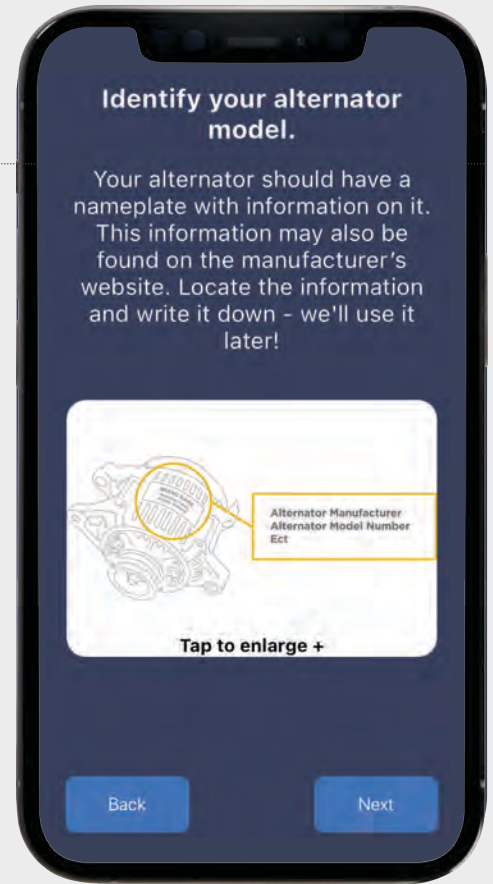

Identify your battery model and arrangement.

Your battery should have a nameplate with information on it, similar to the alternator. This information may also be found on the manufacturer's website. Locate the information and write it down - we'll use it later!

You will need information on your battery. Most batteries have the information you need on their label. It may also be located on their website or by contacting the manufacturer.

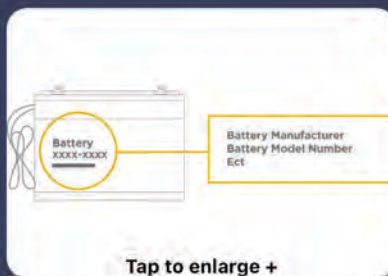

CLICK NEXT
to continue.

For your safety, please ensure that all power is turned off or disconnected before beginning your physical installation of the regulator.

Your off switch may look like the example below.

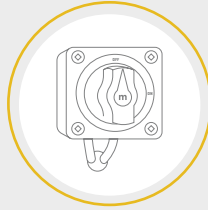

CLICK NEXT
once your power is
disconnected or turned off.

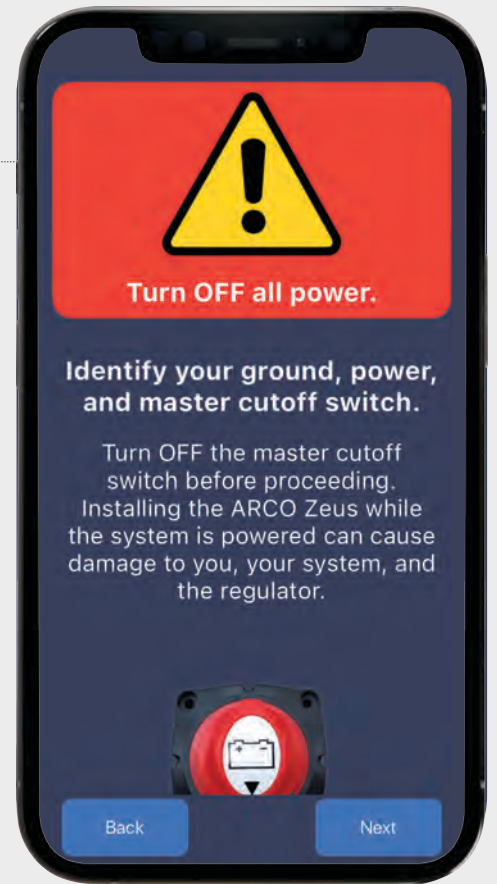

Determine Your ARCO Zeus Install Location

- The regulator should be mounted in a central location with access to your battery.
- The included battery harness is 6ft long.

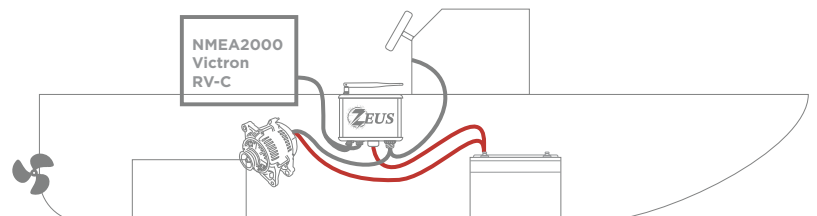
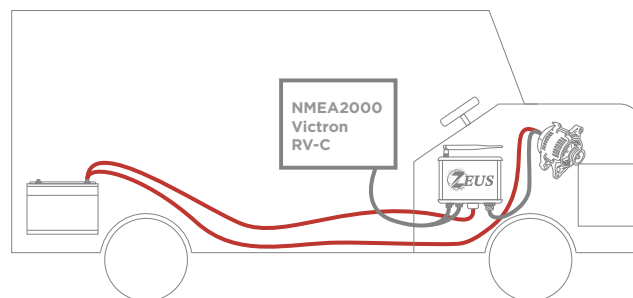

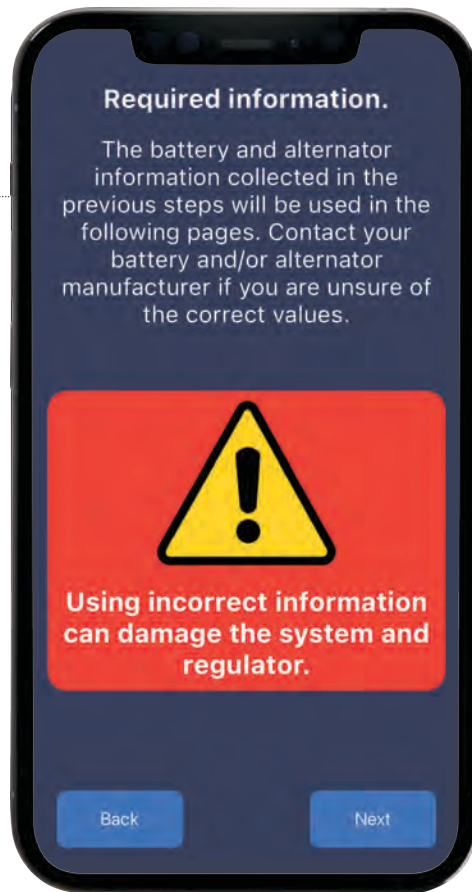

Do not make connections to your wiring harness while it is plugged into your smart regulator.

CLICK NEXT
to continue.

Select your battery type from the list below.

CLICK NEXT
to continue.

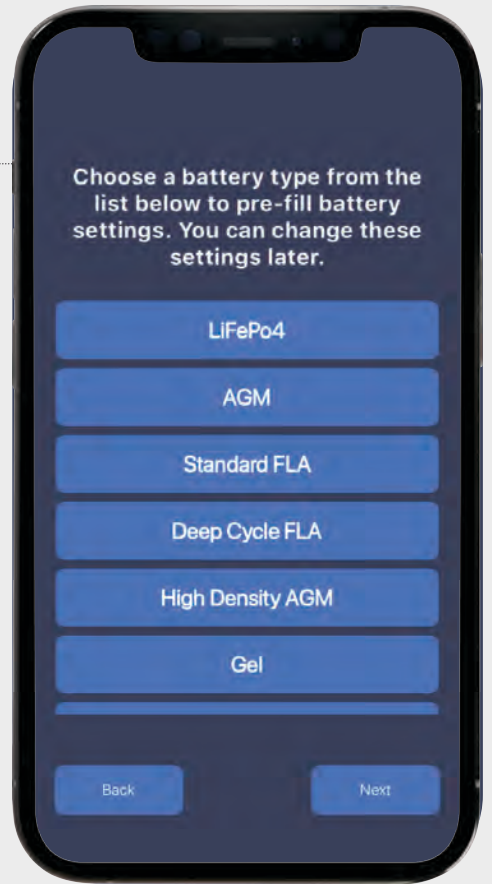

Alternator Info

Alternator Type

To find your alternator type, contact your alternator's manufacturer. Most modern alternators are P type.

P Type

N Type

Tach Poles

The number of poles on the alternator, which determines the number of stator/tachometer pulses per revolution



Tach Poles

required

Drive Ratio

alternator revolutions per engine revolution, which used to display an accurate engine RPM



Drive Ratio

required

Back

Next

To find your alternator type, contact your alternator's manufacturer. **Most modern alternators are P type.**

You can find how many poles your alternator has by contacting the alternator manufacturer. This is important information to ensure that your regulator is capturing your engine's RPM data. **Most alternators have 12, 14 or 16 poles.**



CLICK NEXT
to continue.

Set the parameter of 12v, 24v, 36v, or 48v

This is the total Amp hours of all batteries in the bank, for example, three 300Ah batteries would be 900Ah. Amp hours is the amount of energy charge in a battery that enables one ampere of current to flow for one hour. This information is location on a label on the battery or manufacturer's website.

This information would be found on the label of your battery. Lithium Ion batteries can be subjected to much higher charge currents.

This enables the regulator to account for losses in your system. The default number will be 1. You can fine tune this to match the current measurement from an existing system if it does not match. For example, your Victron Smart Shunt that may show a different measurement.

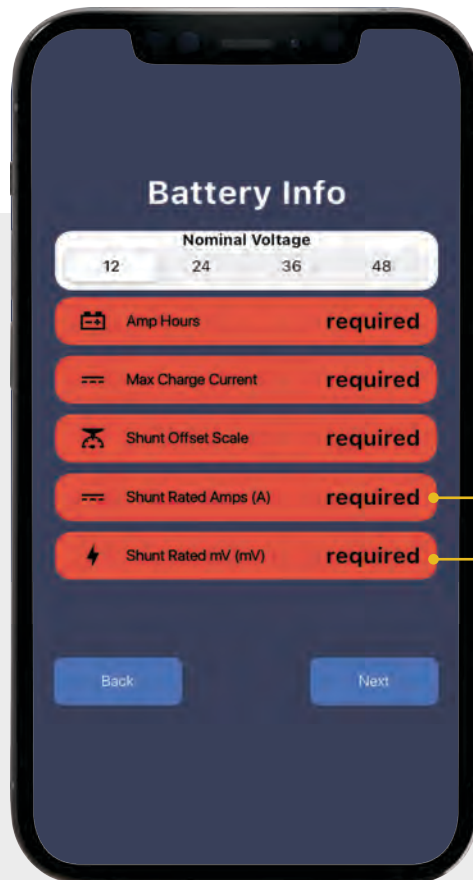
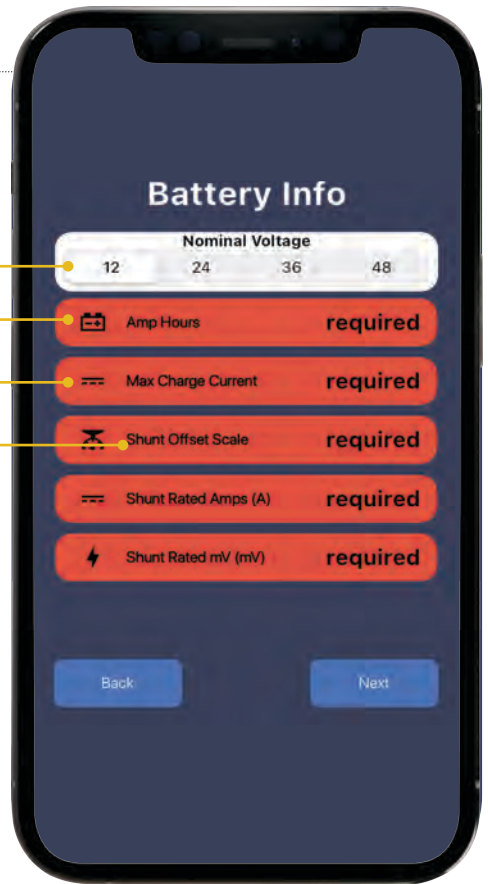

Most shunts are 500a/50mV.

Your Shunt Rated Amps will be on your shunt.

Your Shunt Rated mV (*millivolts*) will be visible on your shunt.

 **CLICK NEXT**
to continue.

■ Voltage Meter

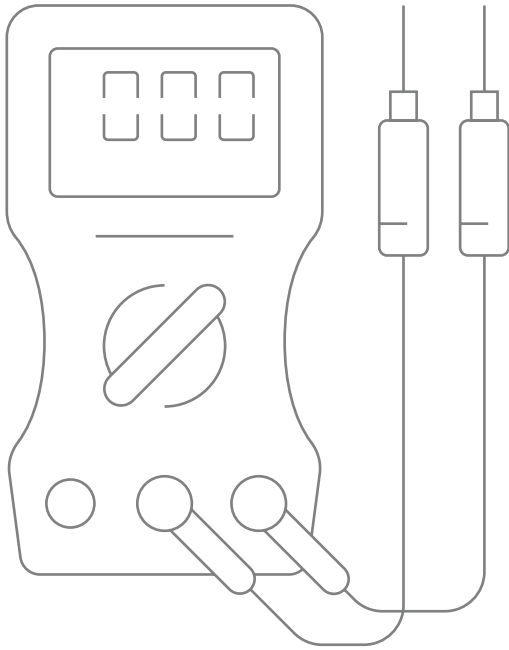

■ Fuse Holder

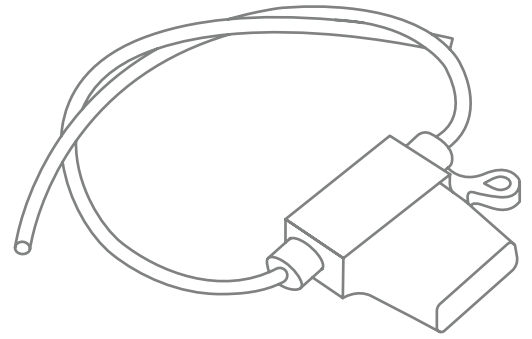

■ Assorted Ring Terminals and Butt Connectors

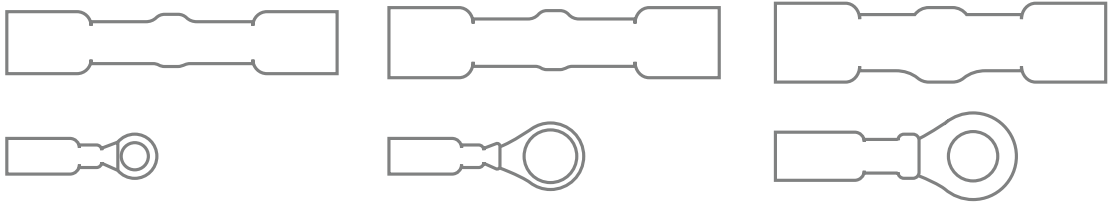

■ Wire Cutters/Strippers

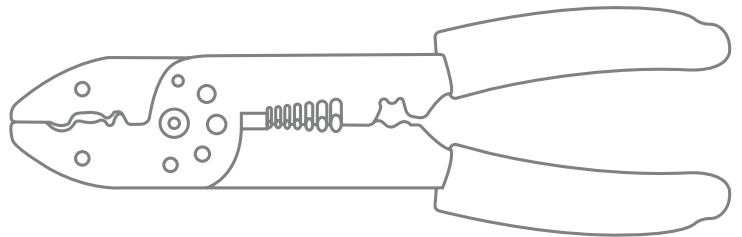

■ Wire Crimpers

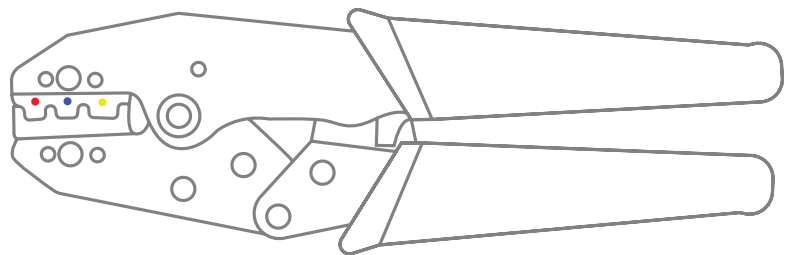

■ Optional Accessories

- Alternator Shunt
- Feature in Switches (Up to 3)

INSTALLATION

Installation Guide v1.2

The preparation for your installation is now finished. Next, you will begin the wiring installation guide. add screenshot attached, but make it look like it is from the ios app and not android, where it was taken from.

CLICK NEXT
to continue.

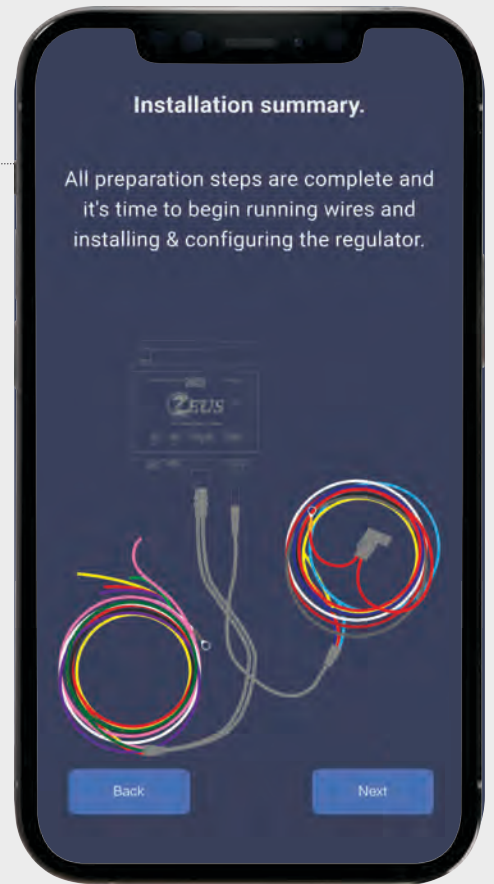

CLICK NEXT
to continue.

STEP

1

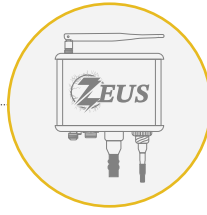

When mounting your smart regulator, if possible, mount it with the connectors facing down to decrease the chance of water ingress. Once your regulator is mounted in a location that is accessible, connect the wiring harness and view the LED.

CLICK NEXT
to continue.



1. Mount the regulator.

Mount your regulator with the wires down and antenna up if possible to decrease chance of water ingress.



Back

Next

STEP

2

2. Always plan ahead. Lay out the wire harness from the regulator to the:

- batteries
- alternator
- helm (if using feature-in switches)



Complete wiring diagram

Back

Next



CLICK NEXT
to continue.

STEP

3

Add fuses to the following wires (wire with inline fuses crimped in place).

- Alternator Field
- Alternator V+
- Battery V+

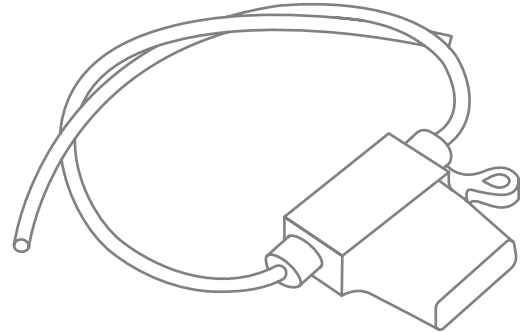

CLICK NEXT
to continue.

STEP

4

Carefully crimp all wires and verify that it matches the diagram.

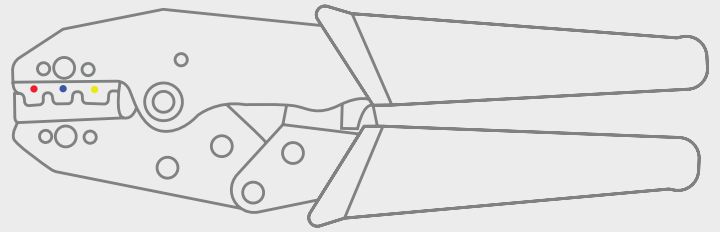

CLICK NEXT
to continue.

STEP

5

Verify all the pins in the wiring harness using a multi meter.

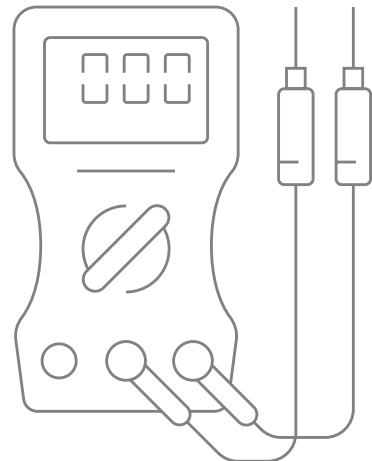

CLICK NEXT
to continue.

Follow your alternator wiring harness connections carefully. The wiring harness instructions are included within this manual and can also be enlarged in the app by long pressing the wiring harness instruction image.

Continue installing wires per the following diagrams, using the Ring Terminals and Butt Connectors where needed.

ALTERNATOR WIRING GUIDE

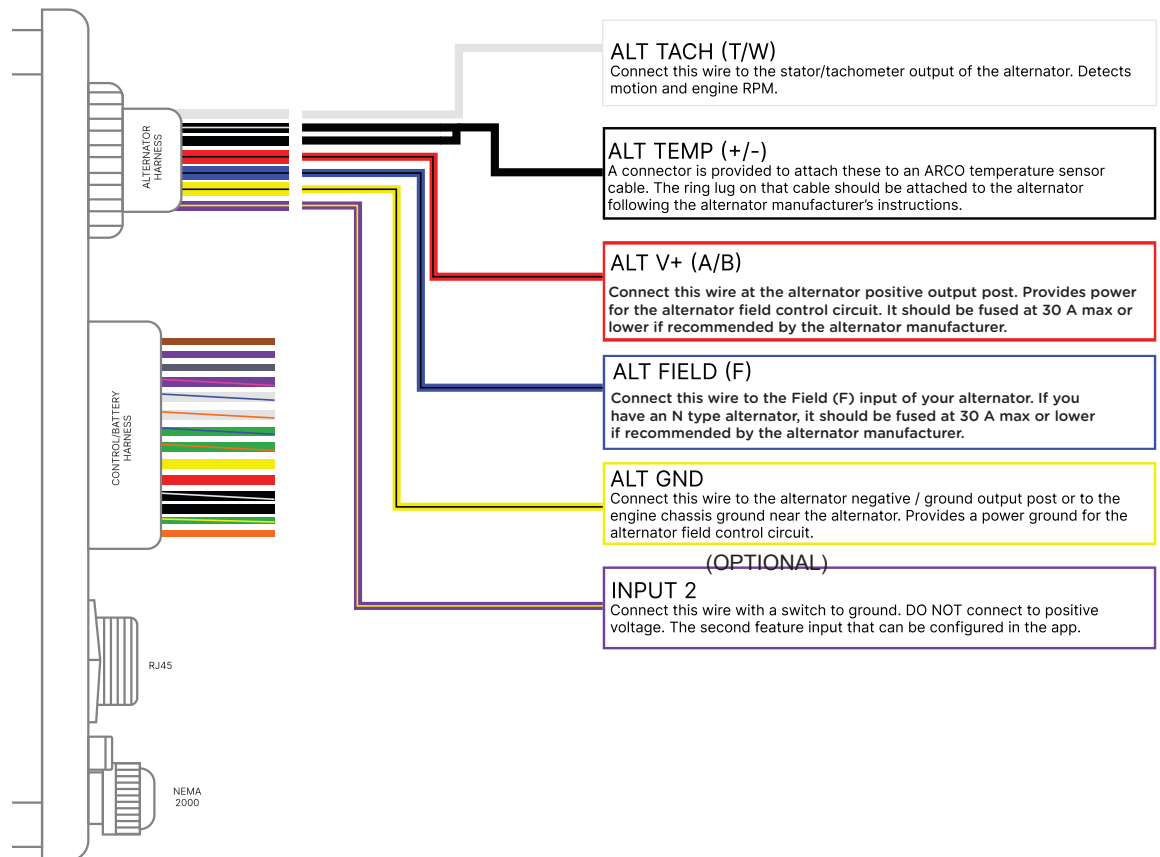

Follow your alternator wiring harness connections carefully. The wiring harness instructions are included within this manual and can also be enlarged in the app by long pressing the wiring harness instruction image.

BATTERY/CONTROL WIRING GUIDE

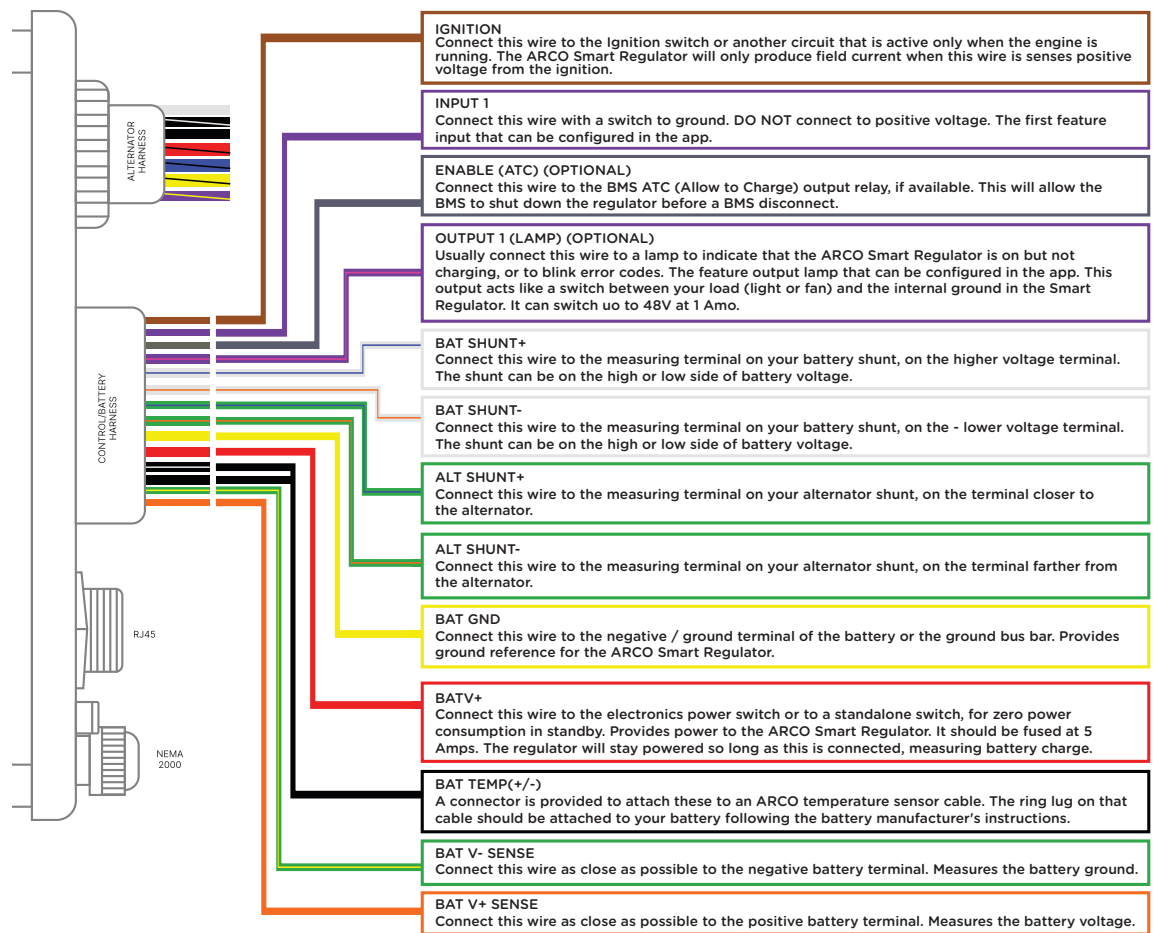

COMPLETE WIRING GUIDE

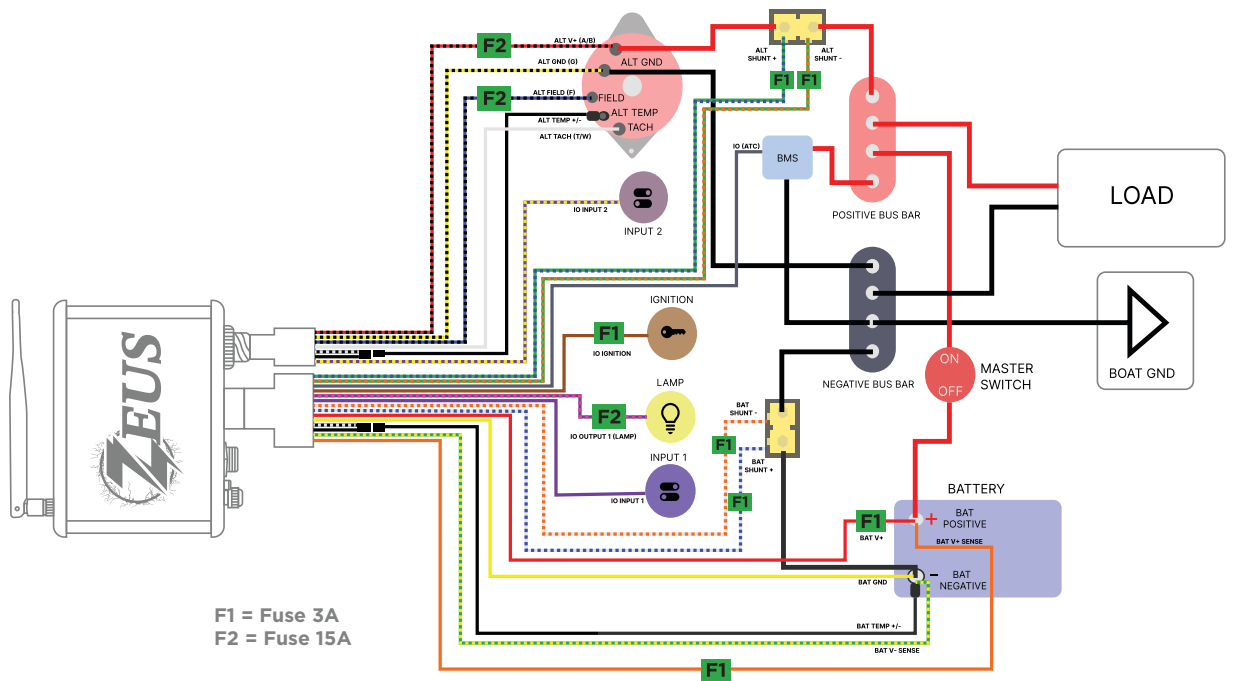

STEP
6

Now that the wiring is ready, it is time to connect these to your Zeus.

CLICK NEXT
to continue.

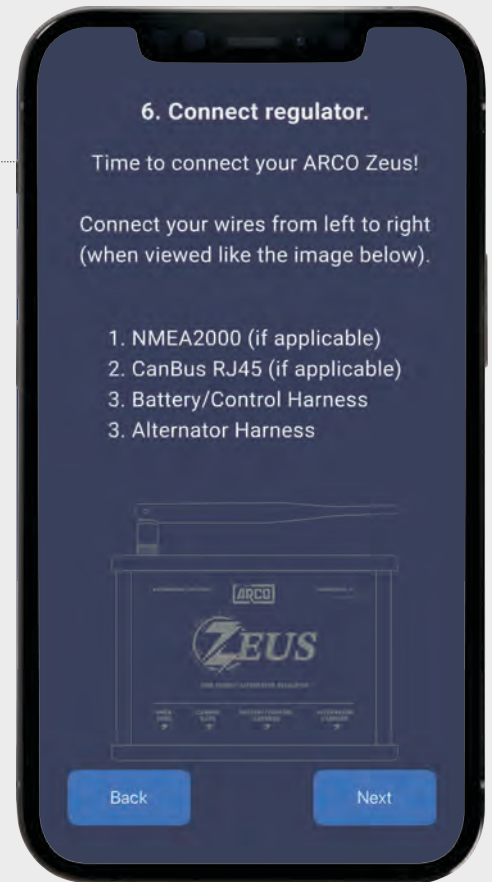

With your regulator connected, you should see your ARCO Zeus in the window provided.



CLICK NEXT
to continue.

Once everything is mounted and connected, turn your power back on.

CLICK NEXT
when complete.

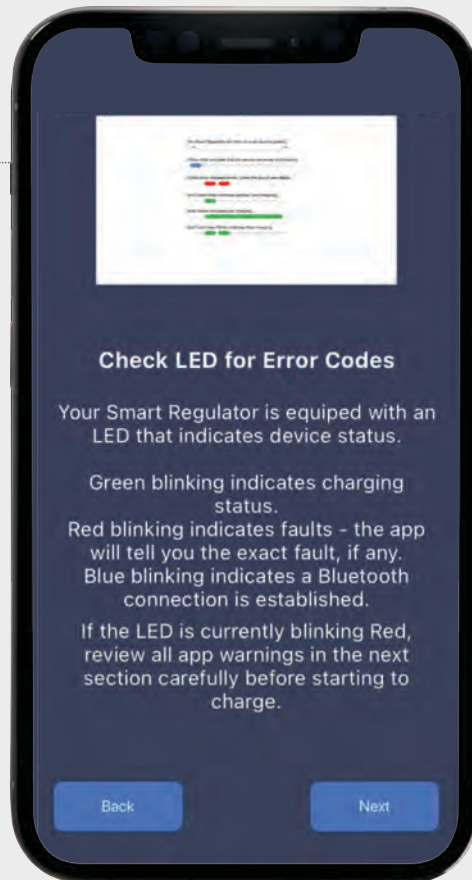
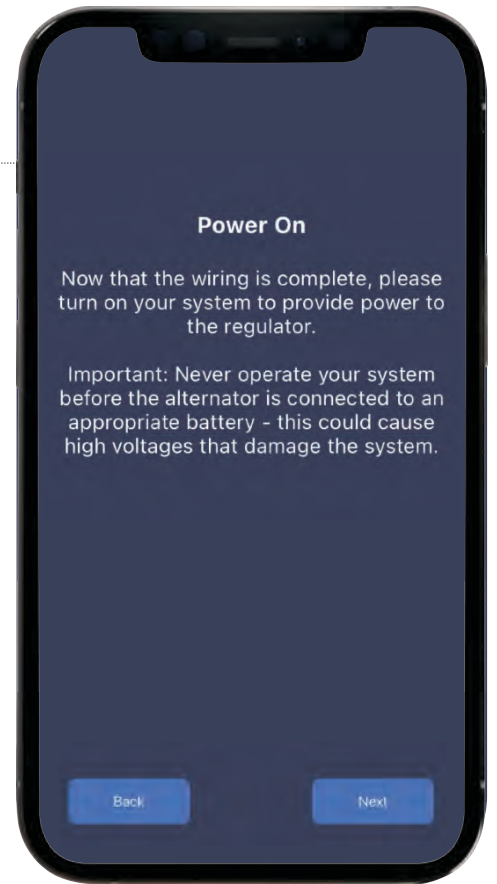

There is an LED light near the ports on your regulator. If the LED is currently blinking red, review all of the app warnings in the next section.



CLICK NEXT
to continue.

- The smart regulator will blink on a six second pattern.



- A blue blink indicates that the device connected to Bluetooth.



- A red blink indicates errors. Open the app to see details.



- One green blink indicates standby (not charging).



- Solid green indicates bulk charging.



- And two green blinks indicates float charging.



CONFIGURATION

Battery Settings | Installation Guide v1.2

Due to the information you have already submitted, we have prefilled your battery settings. Please double check these settings with the information on your battery's label.

CLICK NEXT
to continue.

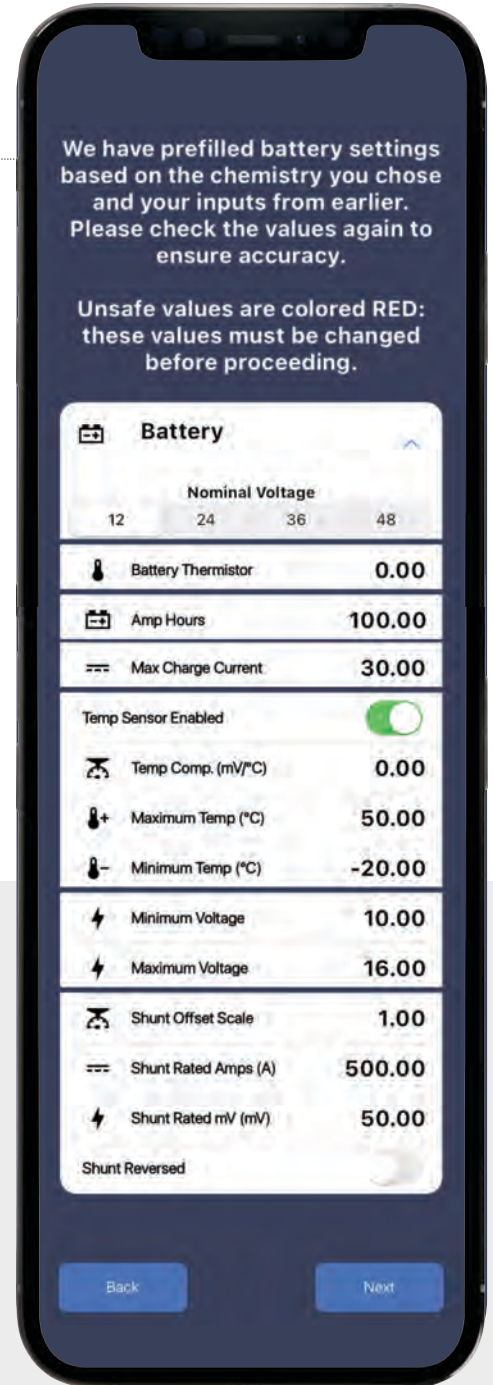

Due to the information you have already submitted for your alternator, we have prefilled your alternator settings. Please check these settings.

CLICK NEXT
to continue.



RPM Limits can be adjusted with the swipe of your finger.

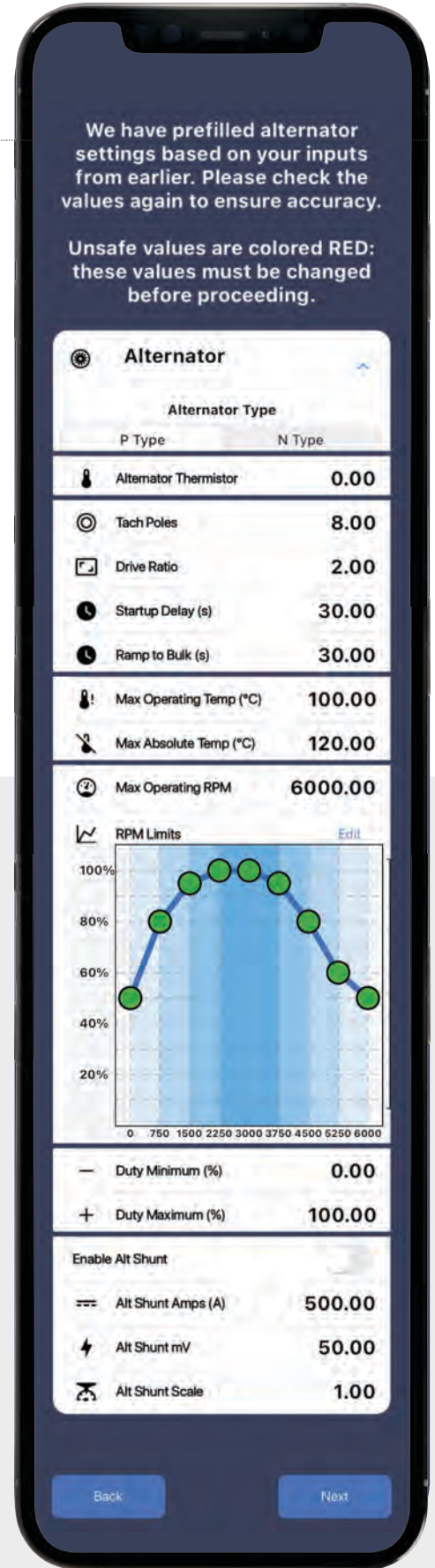

CONFIGURATION

Complete | Installation Guide v1.2

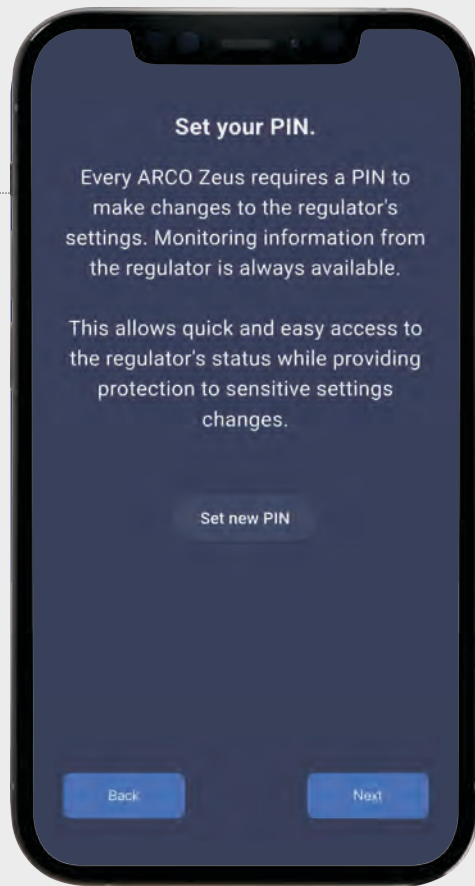

A PIN is required as a layer of security to protect your ARCO Zeus settings from unauthorized users.

CLICK NEXT
to continue.

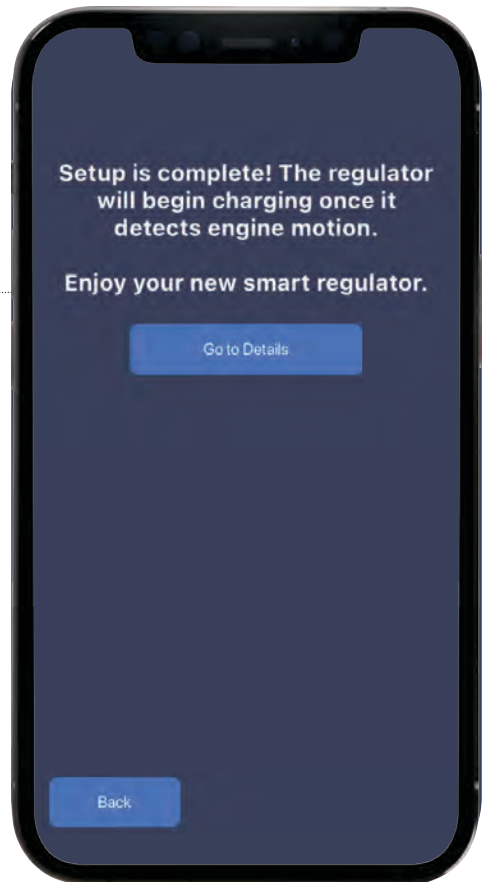

Your setup is now complete.

CLICK GO TO DASHBOARD
to view your dashboard.

