



ECO DROP STEP

PART #: TAC-EDS-N08

FITS: 2005-Up Nissan Frontier Crew Cab



60-120 min





Cutting Not Required



Drilling Not Required

Torque & Tools

Fastener Size	Tightening Torque (ft-lbs)	Wrench Required	Allen Wrench Required	
				
<input type="checkbox"/> 6mm	<input type="checkbox"/> 7-8.5		<input type="checkbox"/> 10mm	<input type="checkbox"/> 4mm
<input checked="" type="checkbox"/> 8mm	<input checked="" type="checkbox"/> 18-20		<input checked="" type="checkbox"/> 13mm	<input type="checkbox"/> 5mm
<input type="checkbox"/> 10mm	<input type="checkbox"/> 35-40		<input type="checkbox"/> 16mm	<input type="checkbox"/> 6mm
<input type="checkbox"/> 12mm	<input type="checkbox"/> 60-70		<input type="checkbox"/> 18mm	<input type="checkbox"/> 8mm

BEFORE INSTALLATION

REMOVE CONTENTS FROM BOX. VERIFY ALL PARTS ARE PRESENT. READ INSTRUCTIONS CAREFULLY BEFORE STARTING INSTALLATION. ASSISTANCE IS RECOMMENDED.

Part List

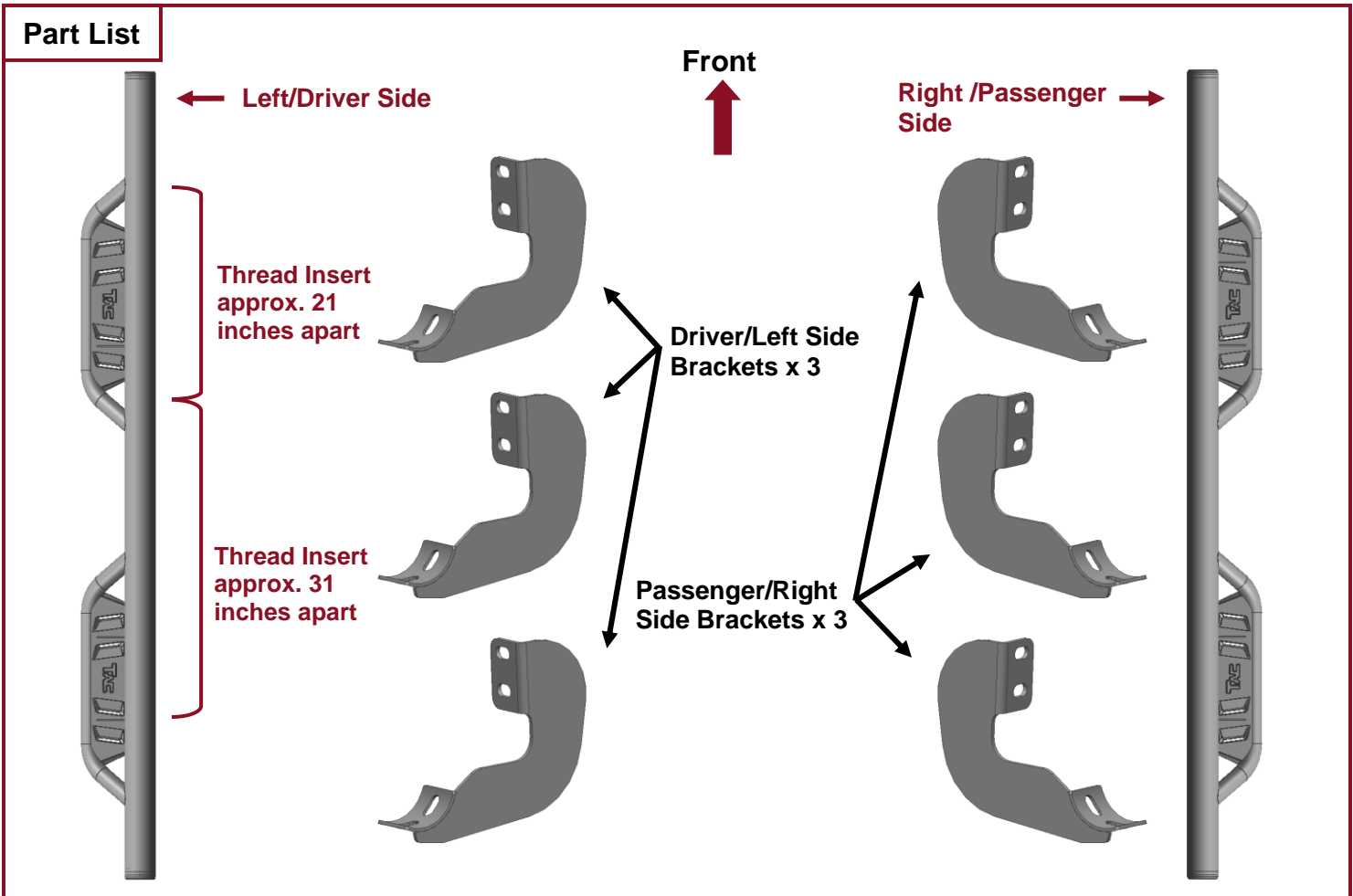

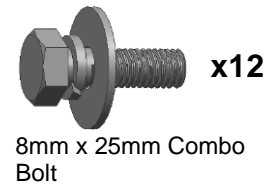

PLEASE NOTE THAT THE FOLLOWING PICTURES ARE BASED ON THE PASSENGER SIDE INSTALLATION

STEP 1

Starting from underneath the Passenger/Right body panel. Locate the front factory mounting location along the inner side of the body, **(Fig 1)**. Use a wire brush or thread chaser die to remove excess paint and/or undercoating from two studs.

FIG 1

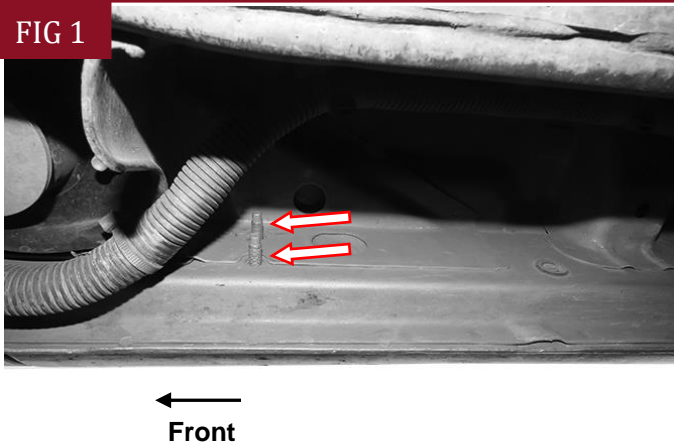

(Fig 1) Passenger/Right front mounting location

STEP 2

Select the (1) Passenger/Right Mounting Bracket. Attach the Bracket to the front location with (2) 8mm Flat Washers and (2) 8mm Flange Nuts, **(Fig 2)**. Do not tighten hardware.

FIG 2

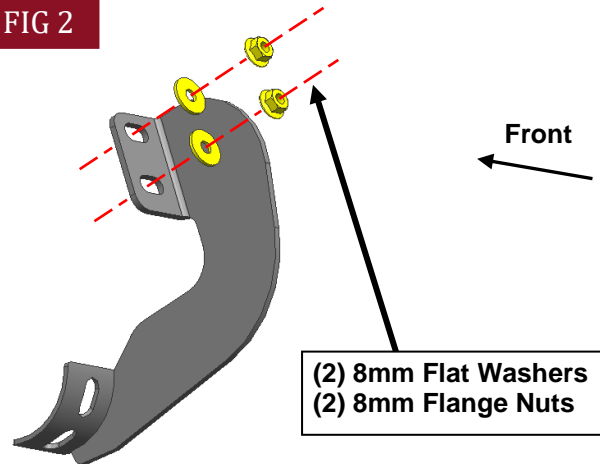

(Fig 2) Attach (1) Passenger/Right Mounting Bracket to the front location

STEP 3

Repeat **Steps 2** to attach (2) Passenger/Right Mounting Brackets to the center and rear locations, **(Figs 3 - 4)**. Do not tighten hardware.

FIG 3

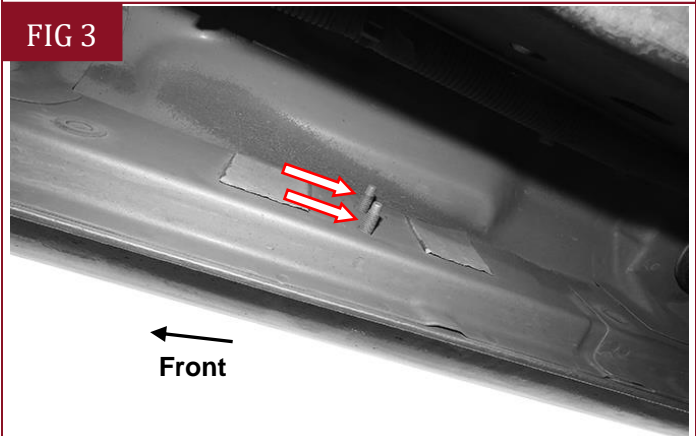

(Fig 3) Passenger/Right center mounting location

FIG 4

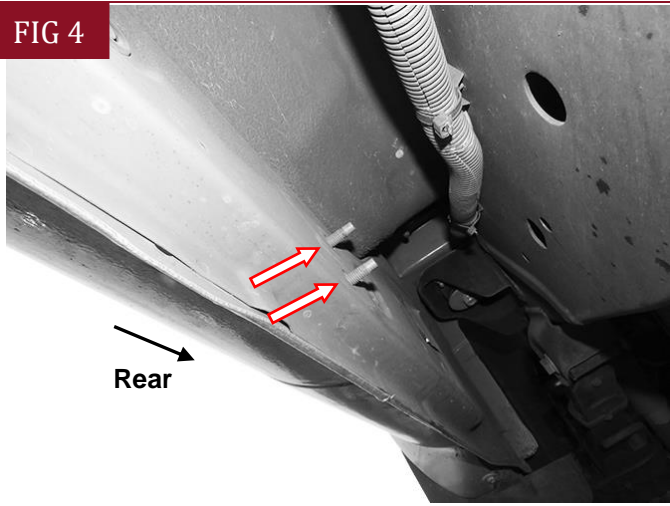

(Fig 4) Passenger/Right rear mounting location

STEP 4

Select the Passenger/Right Running Board.
NOTE: Please identify the Passenger/Right Running Board according to the illustration on Part List. Carefully place Running Board on the brackets. **IMPORTANT:** Do not slide the Running Board front to back or damage to the finish may result. Attach Running Board to the Mounting Brackets with (6) 8mm Combo Bolts, (Fig 5). Do not tighten hardware.

FIG 5

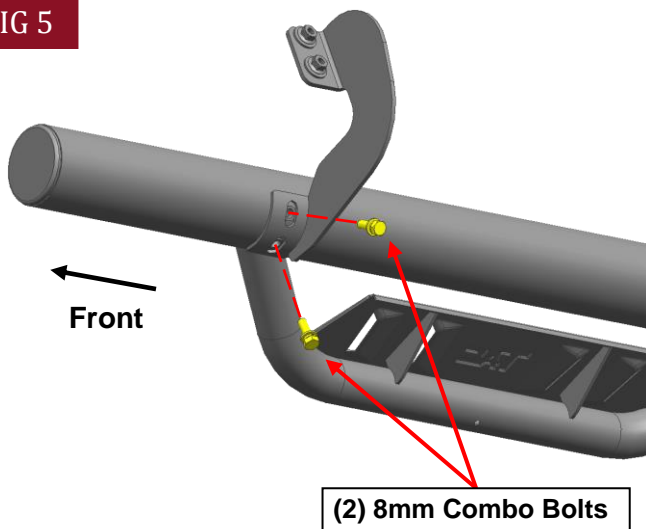

(Fig 5) Attach the Passenger/Right Running Board to the Mounting Brackets

STEP 5

Level and adjust the Running Board and fully tighten all hardware.

STEP 6

Repeat **Steps 1—5** to attach the Driver/Left Running Board.

STEP 7

Do periodic inspections to the installation to make sure that all hardware is secure and tight.

Attention

To protect your investment, do not use any type of polish or wax that may contain abrasives that could damage the finish.

Mild soap may be used also to clean the Running Boards.