



INSTALLATION INSTRUCTIONS

2.5" BULL BAR

**2011-2021 Jeep Grand Cherokee (Incl. 22 WK & Excl. Limited X, SRT, Summit,
Trackhawk, L Model, High Altitude, 80th Anniversary)**

2011-2013 Dodge Durango

PART#72320B

PARTS LIST:

1	Bull Bar
1	Driver/Left Side Frame Mounting Bracket
1	Passenger/Right Side Frame Mounting Bracket
8	10-1.5mm x 35mm Hex Bolts
12	10mm x 30mm OD x 2.5mm Flat Washers
8	10mm Lock Washers
4	10mm Hex Nuts

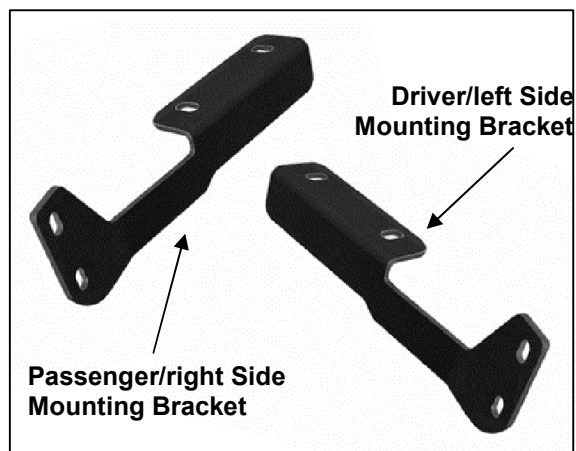

PROCEDURE:

- REMOVE CONTENTS FROM BOX. VERIFY ALL PARTS ARE PRESENT. READ INSTRUCTIONS CAREFULLY BEFORE STARTING INSTALLATION. ASSISTANCE IS RECOMMENDED.**

IMPORTANT: This Bull Bar is not compatible with optional Adaptive Cruise Control-Forward Collision Warning Systems featuring grille mounted laser control sensor. Installation may also interfere with front bumper mounted sensor operation.

- Remove the plastic splash guard, **(Figure 1)**. Pay close attention to the type and location of all factory hardware for easier reinstallation.
- Determine if the vehicle is equipped with or without factory tow hooks, **(Figures 7 & 11A)**.
 - 2011-13 vehicles without factory tow hooks:**
 - Release the clips at the ends of the plastic bumper cover that attach the lower cover to the upper cover, **(Figure 2)**. **NOTE:** It is not necessary to remove the lower cover, only release the clips at the ends of the cover.
 - Remove the (3) large plastic clips fastening the air deflector to the bottom of the crossmember, **(Figure 3)**. Carefully pull the bumper cover forward for access and pull the air deflector out from behind the bumper cover, **(Figure 4)**.
 - Release the clips securing the (2) block off covers to the ends of the air deflector, **(Figure 5)**. Remove the (2) block offs. Reinstall the air deflector using the factory hardware. Reinstall the bumper cover, **(Figure 6)**.
 - 2014 vehicles without tow hooks, (Figure 7):**
 - Remove the hardware attaching the bottom of the driver side front fender liner to the back of the bumper and splash guard, **(Figure 8)**.
 - Pull back the liner and reach up from behind the bumper to locate the plastic cover on each end of the lower grille, **(Figure 9)**.
 - Push to release the plastic clips on the outer edge of the cover to remove the cover from the grille opening, **(Figure 10)**.
 - Repeat this **Step** for passenger side.
 - For models with single piece bumper**
 - Mark the outer locations on the lower grille with tape.
 - Cut the lower grille to access the mounting locations, **(Figure 11)**.
 - All model years equipped with tow hooks, (Figure 12A & 12B):**
 - From under the driver side of the vehicle, locate and remove the large hex nut attaching the inner end of the driver side tow hook to the mounting bracket, **(Figures 12B & 13)**.
 - Remove the (2) factory hex bolts attaching the forward end of the tow hook to the bottom of the cross member and pull the tow hook out through the opening in the bumper.

- c) Remove the (2) hex bolts attaching the mounting bracket to the bottom of the frame rail, **(Figures 14 & 15)**.
- d) Repeat the previous Steps to remove the passenger side tow hook. **NOTE:** Tow hooks cannot be reinstalled with the Bull Bar.
4. Select the driver side Frame Mounting Bracket. Line up the (2) slots in the bracket with the (2) threaded holes in the bottom of the frame channel, **(Figure 16)**. Bolt the Bracket to the frame channel with (2) 10mm x 35mm Hex Bolts, (2) 10mm Flat Washers and (2) 10mm Lock Washers, **(Figure 17)**. Do not tighten hardware at this time.
5. Repeat **Step 4** for passenger side Frame Bracket installation.
6. With assistance, hold the Bull Bar up to the outside of the Mounting Brackets. Attach the Bull Bar to the Mounting Brackets with the included (4) 10mm x 35mm Hex Bolts, (8) 10mm Flat Washers, (4) 10mm Lock Washers and (4) 10mm Hex Nuts, **(Figure 18)**.
7. Align and adjust the Bull Bar and tighten all hardware. Reinstall the splash guard and/or fender liners if loosened or removed, **(see Steps 2 & 3)**.
8. Do periodic inspections to the installation to make sure that all hardware is secure and tight.

To protect your investment, wax this product after installing. Regular waxing is recommended to add a protective layer over the finish. Do not use any type of polish or wax that may contain abrasives that could damage the finish.

For stainless steel: Aluminum polish may be used to polish small scratches and scuffs on the finish. Mild soap may be used also to clean the Bull Bar.

For gloss black finishes: Mild soap may be used to clean the Bull Bar.

Driver/Left Side Installation Pictured

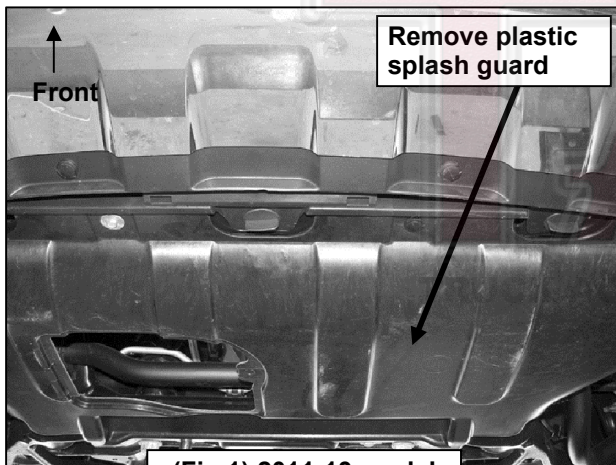

(Fig 1) 2011-13 model



(Fig 2) 2011-13 models-separate lower bumper cover from upper cover at ends

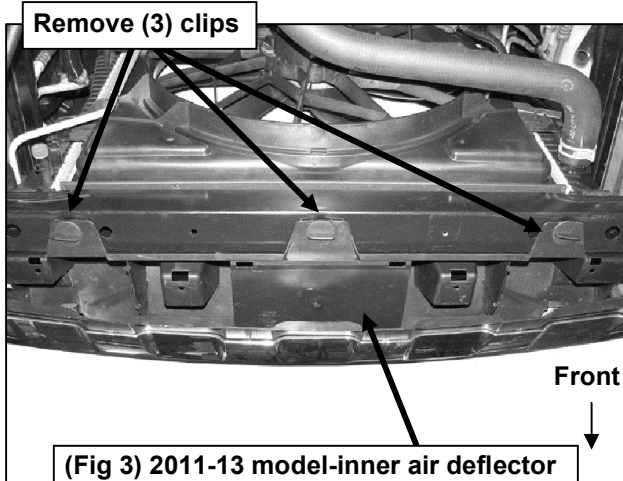

(Fig 3) 2011-13 model-inner air deflector pictured from below front bumper

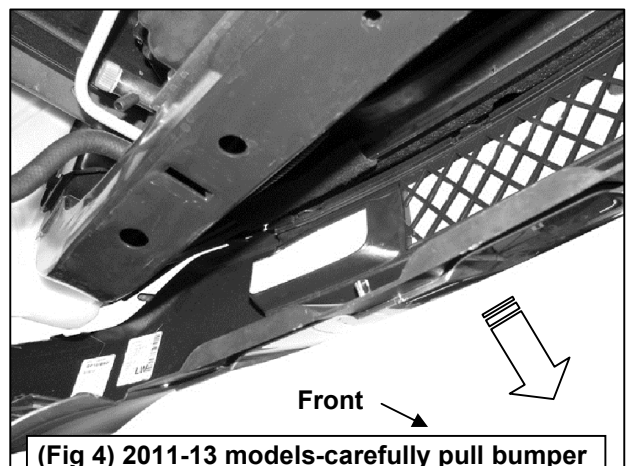

(Fig 4) 2011-13 models-carefully pull bumper cover forward to remove inner air deflector

Driver/Left Side Installation Pictured

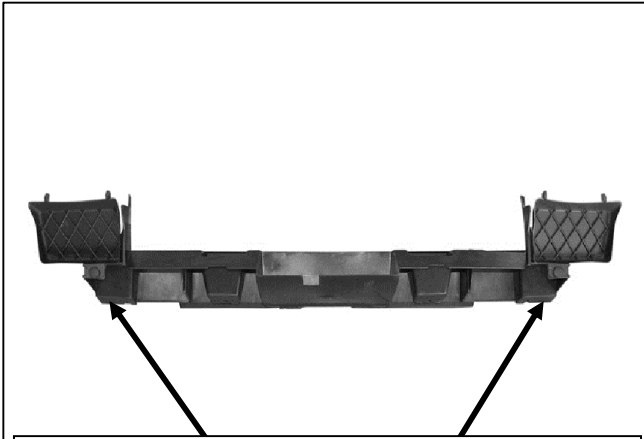

(Fig 5) 2011-13 models-release clips to remove both air block-offs from deflector assembly

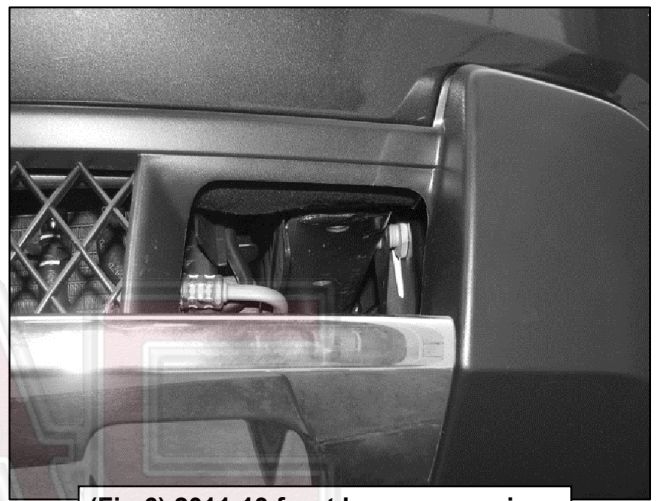

(Fig 6) 2011-13 front bumper opening



(Fig 7) 2014 model block-off pictured

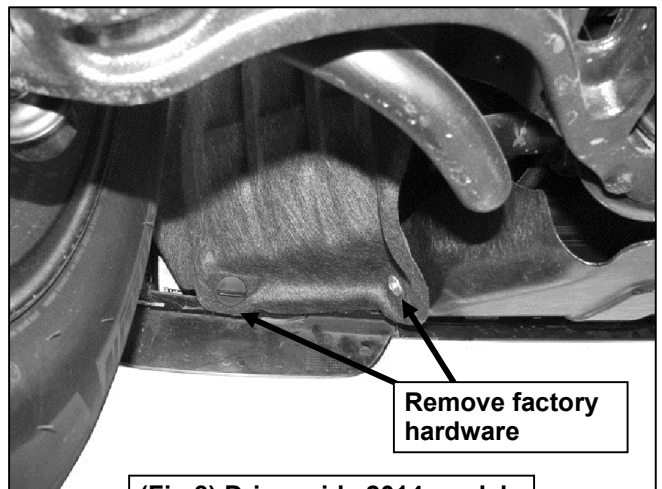

Remove factory hardware

(Fig 8) Driver side 2014 model pictured from behind bumper

Driver/Left Side Installation Pictured



(Fig 9) 2014 model-reach up and in through gap behind bumper to reach and remove block-offs



(Fig 10) Driver side 2014 model pictured



(Fig 11) For models with one piece bumpers, cutting is necessary. Mark the location with tape. Cut the grille to access the mounting location



(Fig 12A) Factory tow hook pictured

Driver/Left Side Installation Pictured

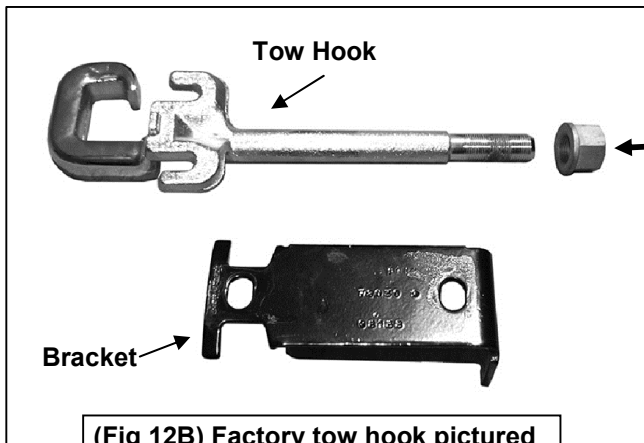

(Fig 12B) Factory tow hook pictured

Remove large hex nut from inner end of tow hook

Remove large hex nut from inner end of tow hook

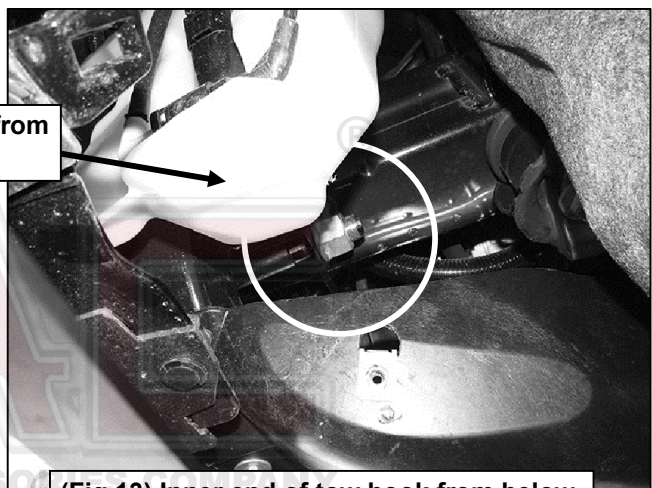

(Fig 13) Inner end of tow hook from below

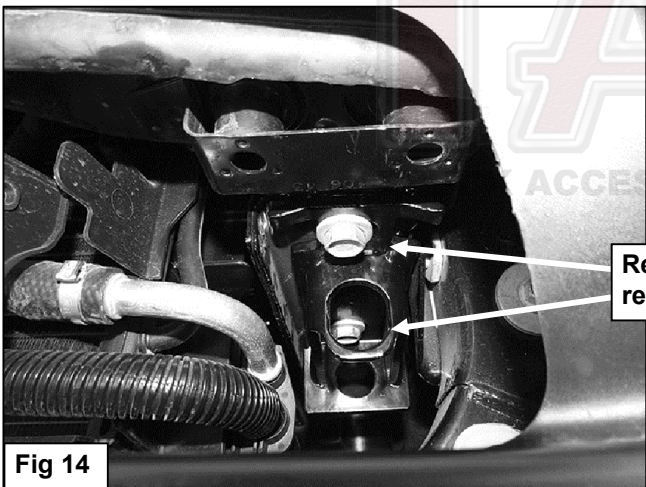
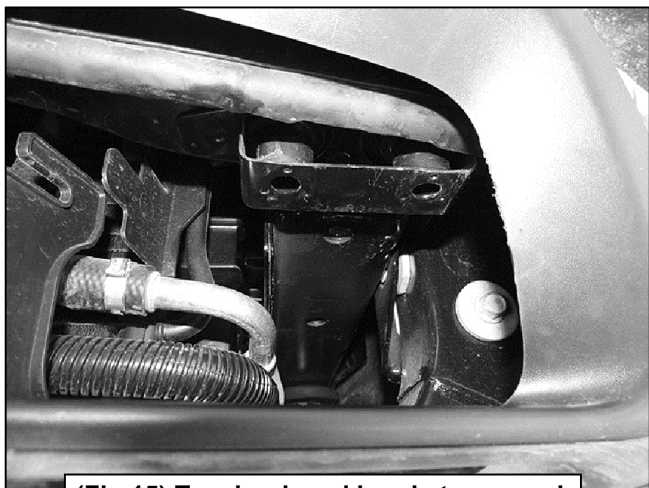

Fig 14

Remove (2) hex bolts to remove tow hook bracket



(Fig 15) Tow hook and bracket removed

Driver/Left Side Installation Pictured

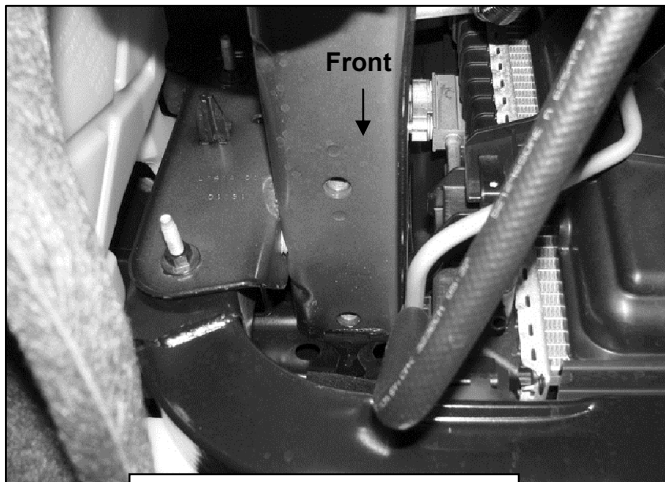

(Fig 16) Driver side mounting location pictured from below

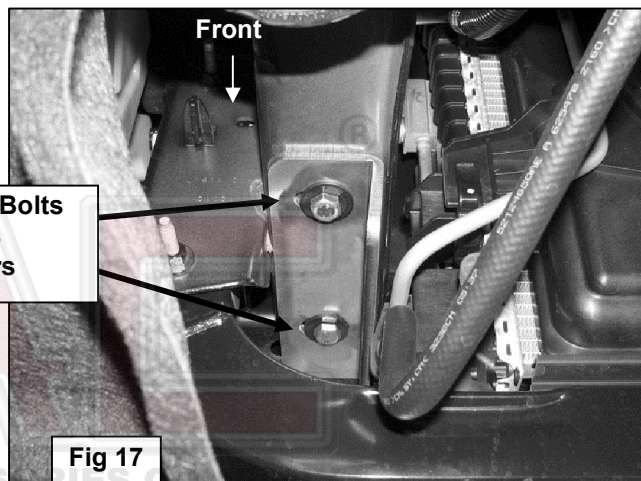

- (2) 10mm x 35mm Hex Bolts
- (2) 10mm Flat Washers
- (2) 10mm Lock Washers

Fig 17

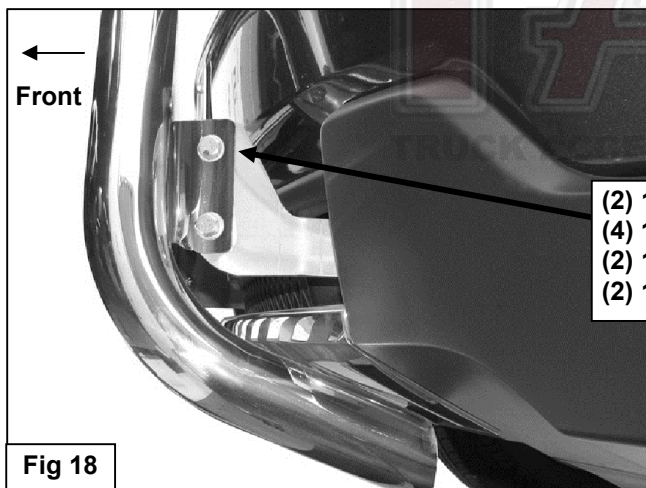

- (2) 10mm x 35mm Hex Bolts
- (4) 10mm Flat Washers
- (2) 10mm Lock Washers
- (2) 10mm Hex Nuts

Fig 18



Complete Installation