



## **INSTALLATION INSTRUCTIONS**

**5IN OVAL STRAIGHT SIDEBAR**

**2019-2022 1500 CHEVY SILVERADO/GMC SIERRA DOUBLE CAB  
(INCLUDES DIESEL MODELS W/DEF & EXCLUDES 2019 SILVERADO 1500 LD &  
2019 SIERRA 1500 LIMITED)**

**2020-2022 SILVERADO/SIERRA 2500/3500 DOUBLE CAB  
(INCLUDES DIESEL MODELS W/DEF)**

**PART# 5S-19C1042**

5IN OVAL STRAIGHT SIDEBAR  
2019-2022 1500 CHEVY SILVERADO/GMC SIERRA DOUBLE CAB  
INCLUDES DIESEL MODELS W/DEF & EXCLUDES 2019 SILVERADO 1500 LD & 2019 SIERRA 1500 LIMITED  
2020-2022 SILVERADO/SIERRA 2500/3500 DOUBLE CAB (INCLUDES DIESEL MODELS W/DEF)

**PARTS LIST:**

1	Driver/left Sidebar	12	8-1.25mm x 30mm Hex Bolts
1	Passenger/right Sidebar	12	8-1.25mm x 25mm Combo Bolts
6	Mounting Brackets	12	8mm Lock Washers
		12	8mm x 24mm x 2mm Flat Washers

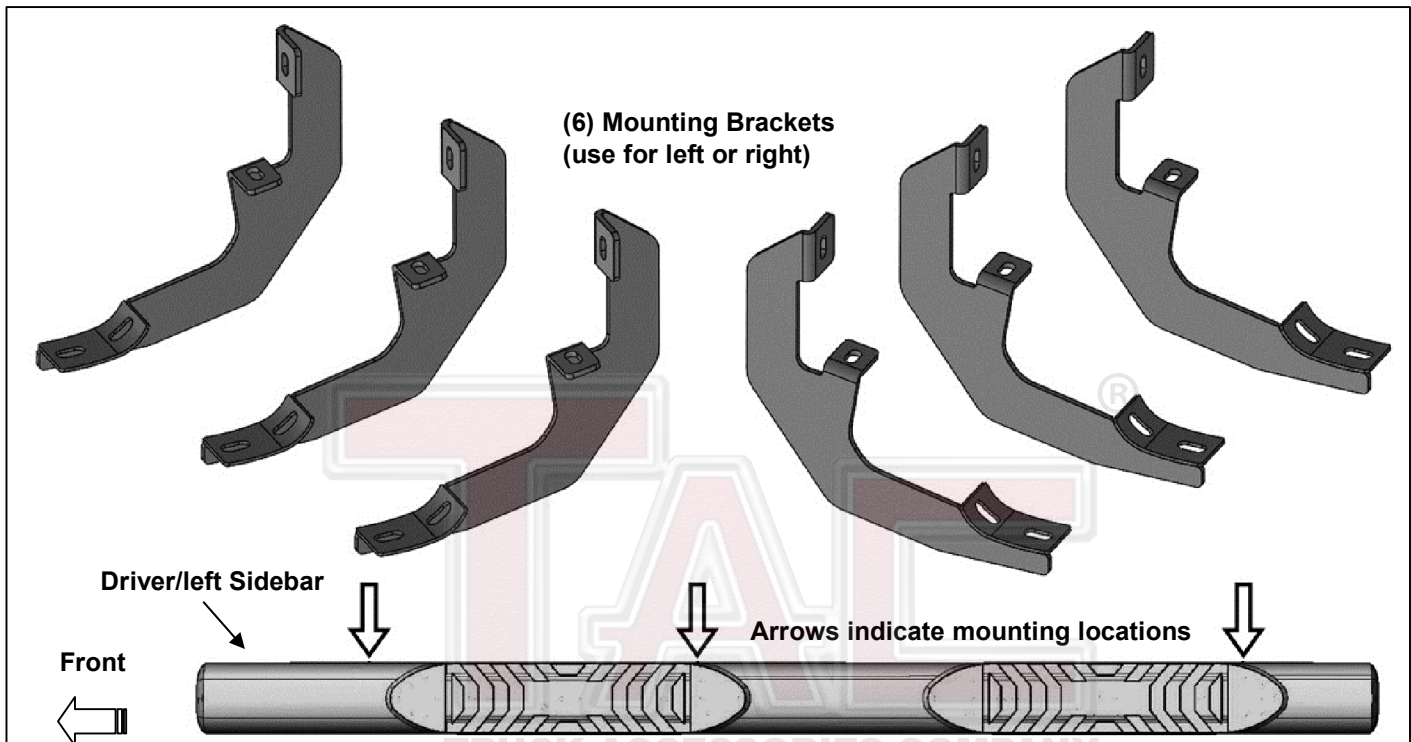

**PROCEDURE:**

**REMOVE CONTENTS FROM BOX. VERIFY ALL PARTS ARE PRESENT. READ INSTRUCTIONS CAREFULLY BEFORE STARTING INSTALLATION. ASSISTANCE IS RECOMMENDED.**

1. Start the installation under the driver/left side of the vehicle. Locate the plastic plugs along the bottom edge of the body. Mounting Brackets will bolt to the 1st, 2nd and 4th threaded mounting holes, **(Figure 1)**. Remove the plastic plugs from each mounting location, **(Figure 2)**. Directly above each threaded insert is a top mounting location on the side of the body panel. Hold a Bracket up in place to help determine the correct mounting holes to use along the body. **NOTE:** Thread an 8mm Hex Bolt into the threaded inserts to clear paint as required.
2. Select (1) Mounting Bracket, **(Figure 3)**. Starting at the front of the driver/left side, attach the Mounting Bracket to the factory threaded holes with (2) 8mm Hex Bolts, (2) 8mm Lock Washers and (2) 8mm Flat Washers, **(Figures 3 & 4)**. Do not fully tighten hardware.
3. Repeat **Steps 1 & 2** to attach the center and rear Brackets to the center and rear mounting locations along the body panel, **(Figures 5 & 6)**.
4. Select the Driver/left Sidebar. Use the illustration above to help determine the correct Sidebar. **NOTE:** The front stepping pad is farther away from the front end of the Sidebar. Place the Sidebar on top of the Brackets. **IMPORTANT:** Do not slide, (front to back), the Sidebar on the Brackets or damage to the finish may result.
5. Attach the Sidebar to the Brackets with (6) 8mm Combo Bolts, **(Figures 7 & 8)**.
6. Level and adjust the Sidebar and fully tighten all hardware.
7. Repeat **Steps 1—6** to install the Passenger/right Sidebar.
8. Do periodic inspections to the installation to make sure that all hardware is secure and tight.

5IN OVAL STRAIGHT SIDEBAR  
2019-2022 1500 CHEVY SILVERADO/GMC SIERRA DOUBLE CAB  
INCLUDES DIESEL MODELS W/DEF & EXCLUDES 2019 SILVERADO 1500 LD & 2019 SIERRA 1500 LIMITED  
2020-2022 SILVERADO/SIERRA 2500/3500 DOUBLE CAB (INCLUDES DIESEL MODELS W/DEF)

**To protect your investment**, wax this product after installing. Regular waxing is recommended to add a protective layer over the finish. Do not use any type of polish or wax that may contain abrasives that could damage the finish. Aluminum polish may be used to polish small scratches and scuffs on the finish. Mild soap may be used also to clean the Sidebars.

### Driver/left side Installation Pictured

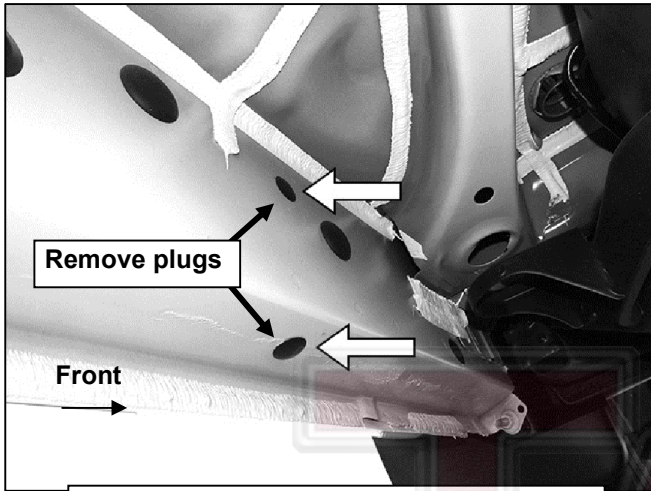

(Fig 1) Driver/left front mounting location

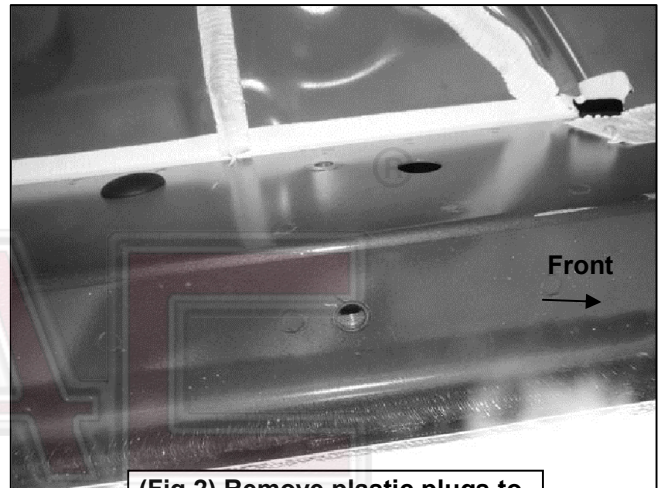

(Fig 2) Remove plastic plugs to uncover threaded inserts

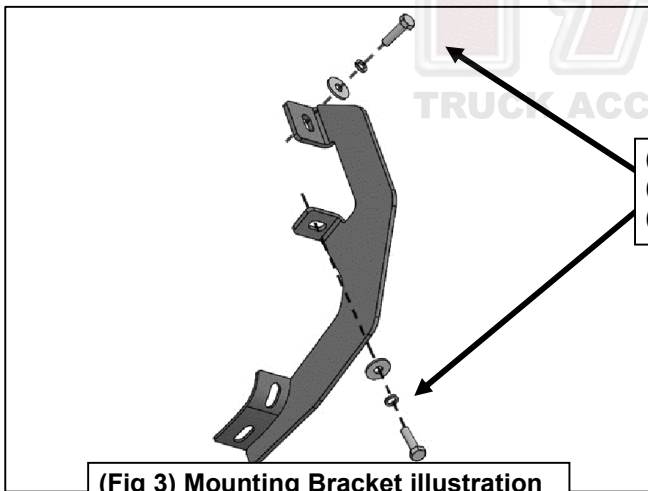

- (2) 8mm Hex Bolts
- (2) 8mm Lock Washers
- (2) 8mm Flat Washers

(Fig 3) Mounting Bracket illustration



(Fig 4) Driver/left front Bracket installed

5IN OVAL STRAIGHT SIDEBAR  
2019-2022 1500 CHEVY SILVERADO/GMC SIERRA DOUBLE CAB  
INCLUDES DIESEL MODELS W/DEF & EXCLUDES 2019 SILVERADO 1500 LD & 2019 SIERRA 1500 LIMITED  
2020-2022 SILVERADO/SIERRA 2500/3500 DOUBLE CAB (INCLUDES DIESEL MODELS W/DEF)

**Driver/left side Installation Pictured**

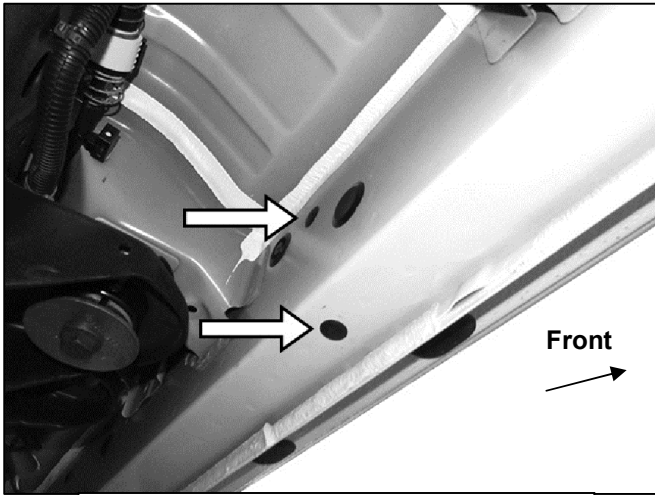

(Fig 5) Driver side 2<sup>nd</sup> mounting location



(Fig 6) Driver side rear mounting location

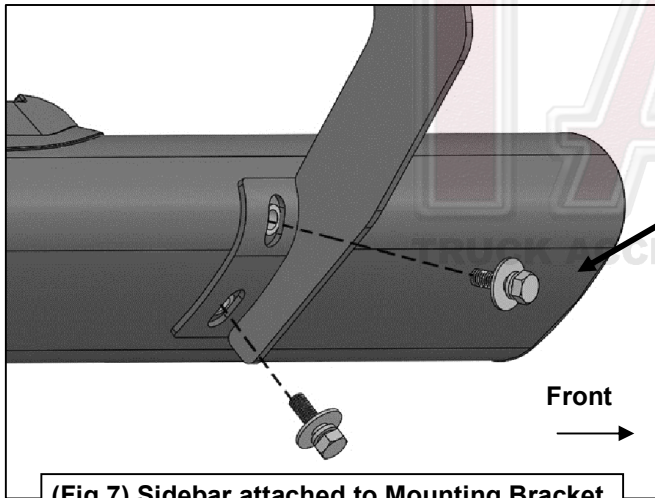

(2) 8mm Combo Bolts

(Fig 7) Sidebar attached to Mounting Bracket

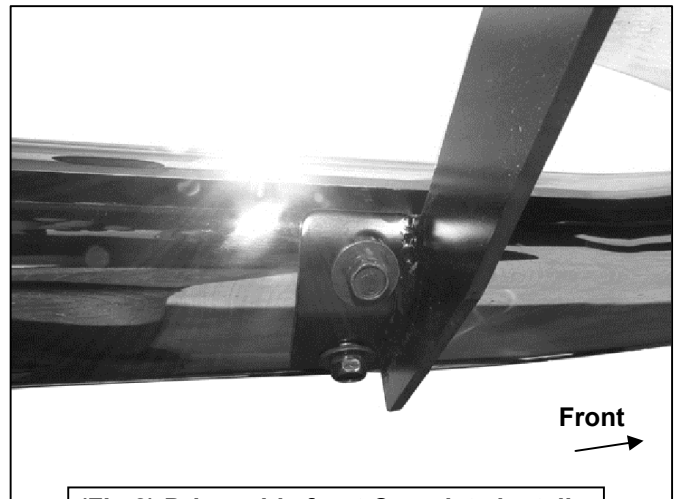

(Fig 8) Driver side front Complete install