



INSTALLATION INSTRUCTIONS

UPGRADED 4INCH STRAIGHT END SIDEBARS

2007-2021 TOYOTA TUNDRA DOUBLE CAB

PART# 4S-T1042-1

PARTS LIST:

1	Driver/Left Sidebar	1	Driver/Left Rear Mounting Bracket
1	Passenger/Right Sidebar	1	Passenger/Right Rear Mounting Bracket
1	Driver/Left Front Mounting Bracket	12	8mm x 30mm Hex Bolts
1	Passenger/Right Front Mounting Bracket	12	8mm x 25mm Combo Bolts
1	Driver/Left Center/Mounting Bracket	12	8mm Lock Washers
1	Passenger/Right Center Mounting Bracket	12	8mm x 24mm OD x 2mm Flat Washers

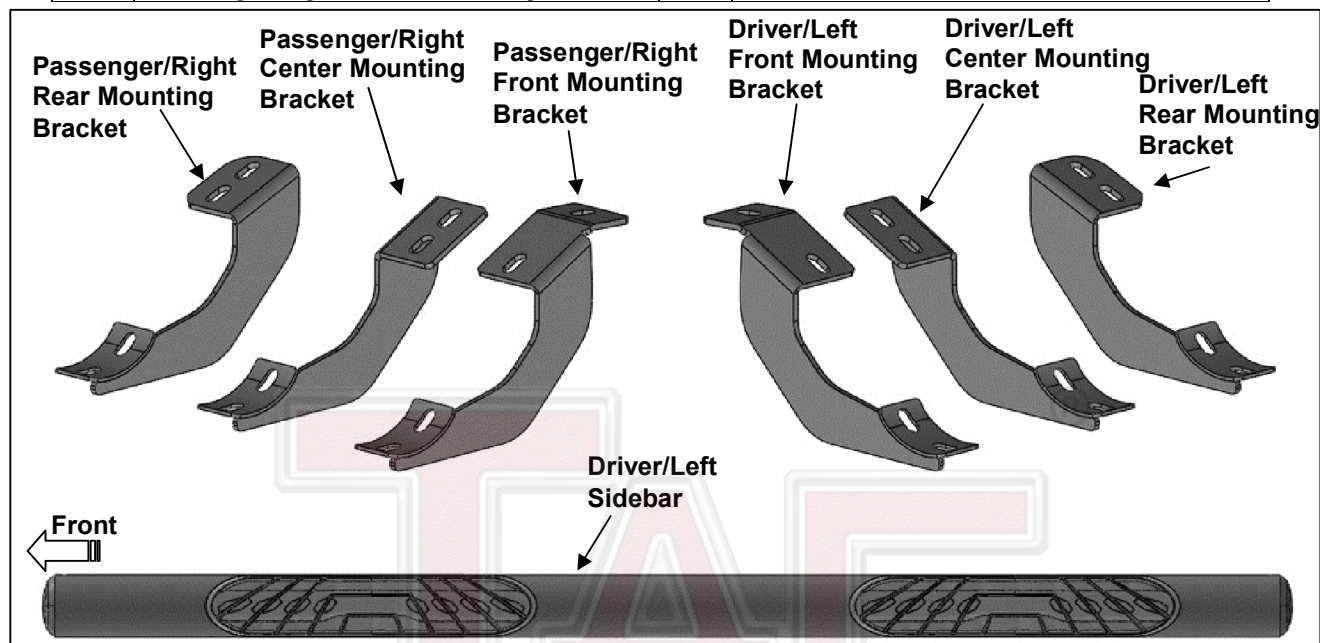

PROCEDURE:

- 1. REMOVE CONTENTS FROM BOX. VERIFY ALL PARTS ARE PRESENT. READ INSTRUCTIONS CAREFULLY. USE ILLUSTRATION TO IDENTIFY BRACKETS AND RUNNING BOARDS.**
- Starting on the Driver/Left front of the vehicle, remove the plastic plugs or hex bolts covering the (2) threaded holes in the floor panel, **(Figure 1)**.
- Select Driver/Left Front Mounting Bracket, **(Figure 2)**. Attach the Bracket to the panel with (2) 8mm Hex Bolts, (2) 8mm Lock Washers and (2) 8mm Flat Washers, **(Figure 2)**. Do not tighten hardware.
- Next, move to the second mounting location, **(Figure 3)**. Select (1) Center Mounting Bracket. Repeat **Step 3** to attach the Bracket to the floor panel, **(Figure 4)**.
- Continue to the rear mounting location, **(Figure 5)**. Repeat **Step 3** to attach (1) Rear Mounting Bracket to the floor panel.
- Select the Driver/Left Upgraded 4inch Sidebar. Place the Sidebar onto the Mounting Brackets. **IMPORTANT:** Do not slide front to back or rotate or damage to the finish may result. Attach the Sidebar to the Mounting Brackets with (6) 8mm Combo Bolts, **(Figure 6)**. Do not tighten hardware.
- Level and adjust the Upgraded 4inch Sidebar and tighten all hardware.
- Repeat **Steps 2—7** to attach the Passenger/Right Upgraded 4inch Sidebar.
- Do periodic inspections to the installation to make sure that all hardware is secure and tight.

To protect your investment, Do not use any type of polish or wax that may contain abrasives that could damage the finish. Mild soap may be used to clean the Sidebars.

Driver/Left Side Installation Pictured

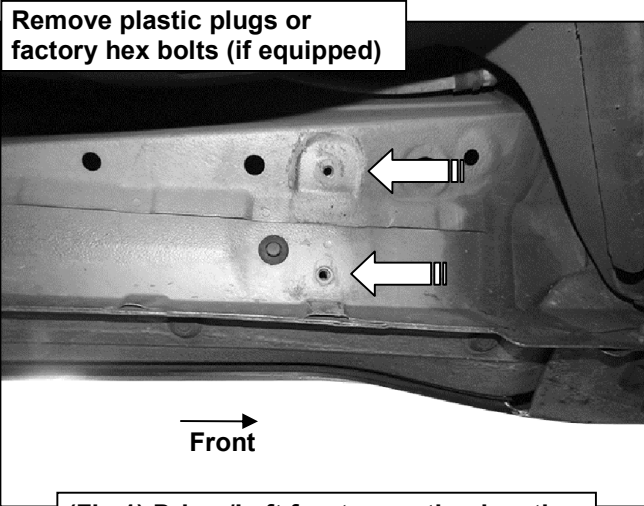

(Fig 1) Driver/Left front mounting location

- (2) 8mm Hex Bolts
- (2) 8mm Lock Washers
- (2) 8mm Flat Washers

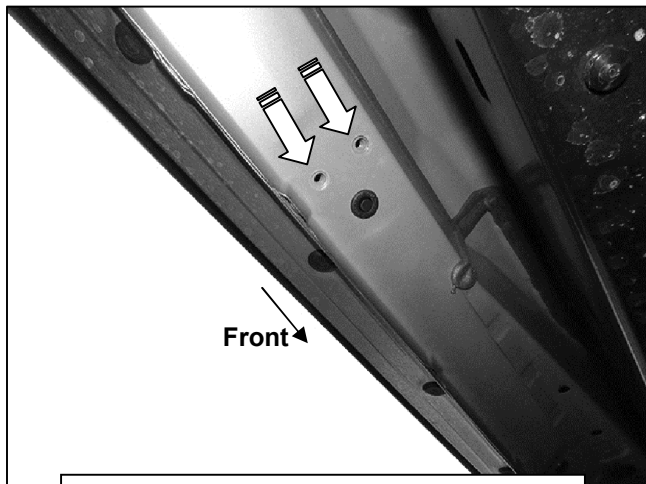
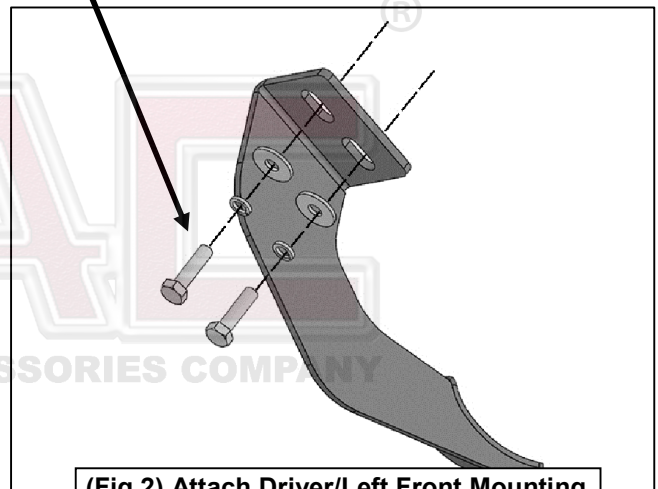

(Fig 3) Driver/Left 2nd mounting location

Driver/Left Side Installation Pictured

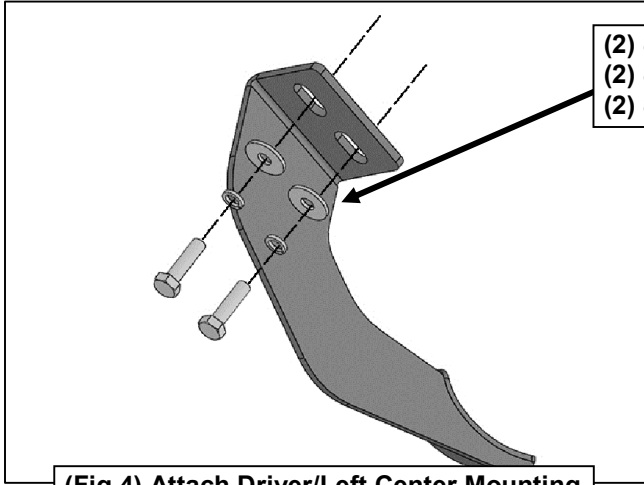

- (2) 8mm Hex Bolts
- (2) 8mm Lock Washers
- (2) 8mm Flat Washers

(Fig 4) Attach Driver/Left Center Mounting Bracket to the floor panel

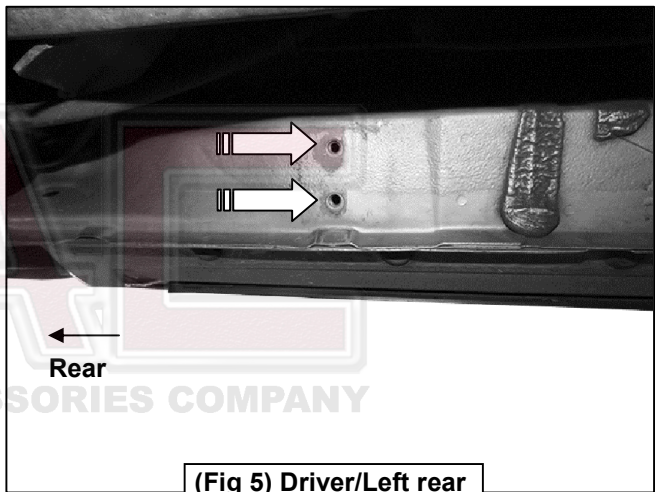

(Fig 5) Driver/Left rear mounting location

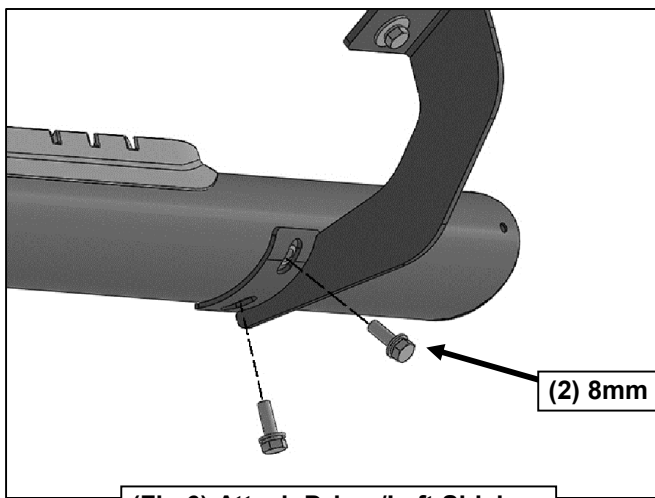

- (2) 8mm Combo Bolts

(Fig 6) Attach Driver/Left Sidebar to the Front Mounting Bracket