



INSTALLATION INSTRUCTIONS

3INCH SIDEBARS

2022-2024 GRAND CHEROKEE

(Exclude 2021-2024 Grand Cherokee L / 2022-2024 4xe Models)

PART# 3S-J2342

TRUCK ACCESSORIES COMPANY

PARTS LIST:

1	Driver/Left Sidebar	1	10mm x 40mm Hex Bolt
1	Passenger/Right Sidebar	3	10mm Lock Washers
1	Driver/Left Front Mounting Bracket	3	10mm x 30mm OD x 2.5mm Flat Washers
1	Passenger/Right Front Mounting Bracket	1	10mm x 27mm OD x 3mm Flat Washer
1	Driver/Left Center Mounting Bracket	1	10mm Hex Nut
1	Passenger/Right Center Mounting Bracket	1	10mm Threaded Insert
1	Driver/Left Rear Mounting Bracket	1	10mm Insert Tool
1	Passenger/Right Rear Mounting Bracket	12	8mm Combo Bolts
3	12mm x 50mm Hex Bolts	6	6mm Bolt Plates
3	12mm Lock Washers	6	6mm x 18mm OD x 1.6mm Flat Washers
3	12mm x 32mm OD x 3mm Flat Washers	6	6mm Lock Washers
3	10mm x 50mm Hex Bolts	6	6mm Hex Nuts

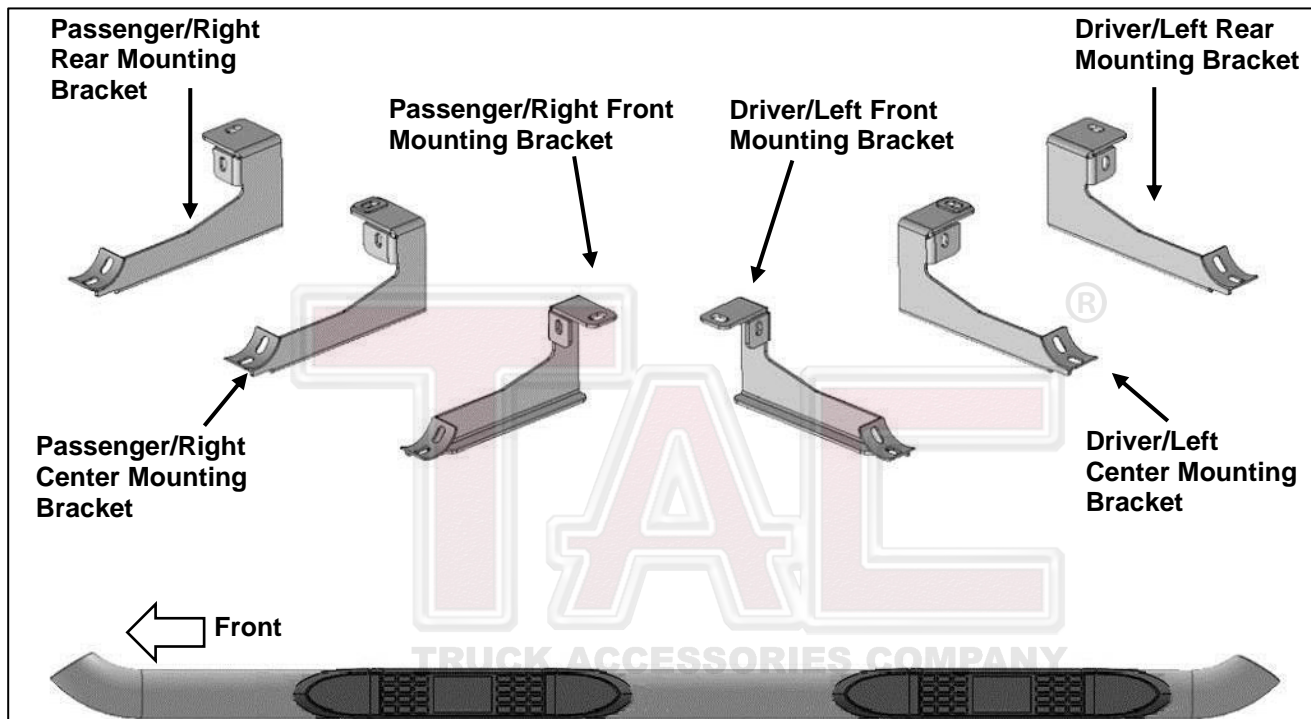

*Notice: Center Bracket contains metal excess on top to identify between center and rear bracket

PROCEDURE:

- REMOVE CONTENTS FROM BOX. VERIFY ALL PARTS ARE PRESENT. READ INSTRUCTIONS CAREFULLY. USE ILLUSTRATION TO IDENTIFY BRACKETS AND SIDE BARS.**
- Starting on the Driver/Left front of the vehicle, remove the cover on the bottom of the vehicle. Select the Driver/Left Front Mounting Bracket. Attach the Mounting Bracket to the threaded insert in the front location with (1) 12mm Hex Bolt, (1) 12mm Lock Washer and (1) 12mm Flat Washer, **(Figures 1 & 2)**. Do not tighten hardware.
- Attach the Mounting Bracket to the pinch trim with (1) 6mm Bolt Plate, (1) 6mm Flat Washer, (1) 6mm Lock Washer and (1) 6mm Hex Nut, **(Figure 3)**. Do not tighten hardware.
- Move along the body panel to the center mounting location, **(Figure 4)**. Select the Driver/Left Center Mounting Bracket. Repeat **Step 2** to install the Bracket, **(Figures 3 & 4)**. Do not tighten hardware.
- Continue to the rear mounting location in front of the rear tire, **(Figure 5)**. Select the Driver/Left Rear Mounting Bracket. Attach the Bracket to the threaded insert with (1) 10mm Hex Bolt, (1) 10mm Lock Washer and (1) 10mm Flat Washer, **(Figures 5 & 6)**. Do not tighten hardware. Repeat **Step 3** to attach the Bracket to the pinch trim.
- Unwrap the Driver/Left Sidebar. Place the Sidebar on top of the (3) Mounting Brackets. Lift the Side Bar up and guide the studs down through the Brackets. **IMPORTANT:** Do not slide the Side Bar on the Brackets, (front to back or rotate), or the finish on the Side Bar may be damaged.
- Attach the Side Bar to the Brackets with (6) 8mm Combo Bolts, **(Figure 7)**. Do not tighten hardware.

8. Level and adjust the Sidebar and tighten all hardware.
9. Move to the Passenger/Right side. Repeat **Steps 2,3 & 5** to attach the Passenger/Right Front and Rear Mounting Brackets.
10. Locate the center mounting location, (**Figure 8**). Select the Passenger/Right Center Mounting Bracket. Hold the Bracket and line up to the hole in the pinch trim to the lower slot in the top of the Bracket. Mark where the top slot is located on the floor panel. Using a 1/2" drill bit, (not included) to drill through only the bottom layer of the floor panel.
11. Select the 10mm Threaded Insert and the 10mm Insert Tool. Push the Tool and Insert assembly into the factory hole. **NOTE:** If Insert fits too tight, lightly tap it into place with a small hammer.
12. Firmly hold the handle on the Tool and tighten the hex bolt in the Insert until it is fully collapsed and locked in place, (**Figures 9 & 10**). **NOTE:** Do not over tighten the Insert or a pull out may occur. Once Insert is collapsed, remove the tool from the Insert.
13. Attach the Passenger/Right Center Mounting Bracket to the Threaded insert with (1) 10mm Hex Bolt, (1) 10mm Lock Washer and (1) 10mm Flat Washer. Do not tighten hardware. Repeat **Step 3** to attach the Bracket to the pinch trim.
14. Repeat **Step 6** to attach the Passenger/Right Sidebar. Do not tighten hardware.
15. Level and adjust the Sidebar and tighten all hardware.
16. Do periodic inspections to the installation to make sure that all hardware is secure and tight.

To protect your investment, Do not use any type of polish or wax that may contain abrasives that could damage the finish. Mild soap may be used to clean the Sidebars.

Driver Side Installation Pictured

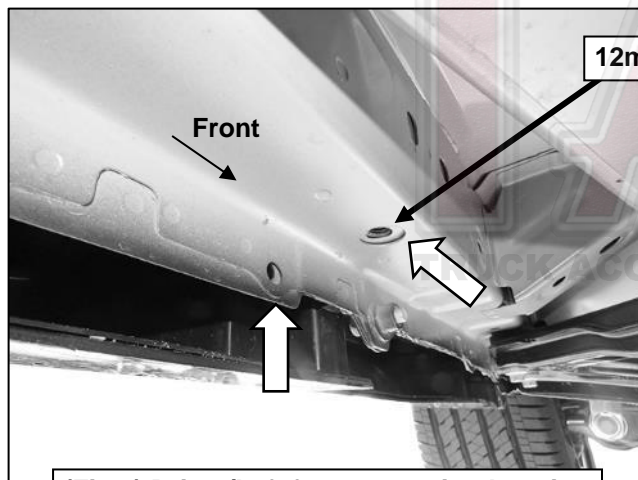

(Fig 1) Driver/Left front mounting location

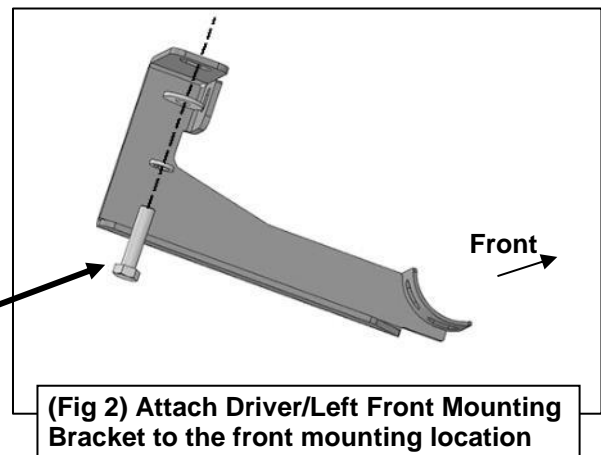

(Fig 2) Attach Driver/Left Front Mounting Bracket to the front mounting location

Driver Side Installation Pictured

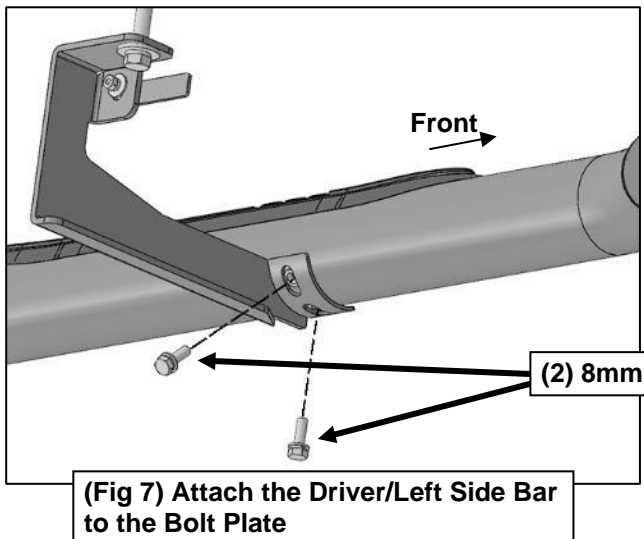
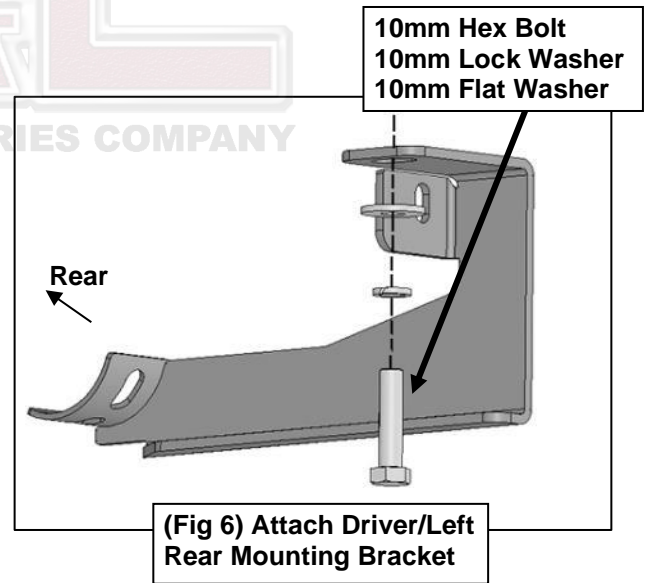
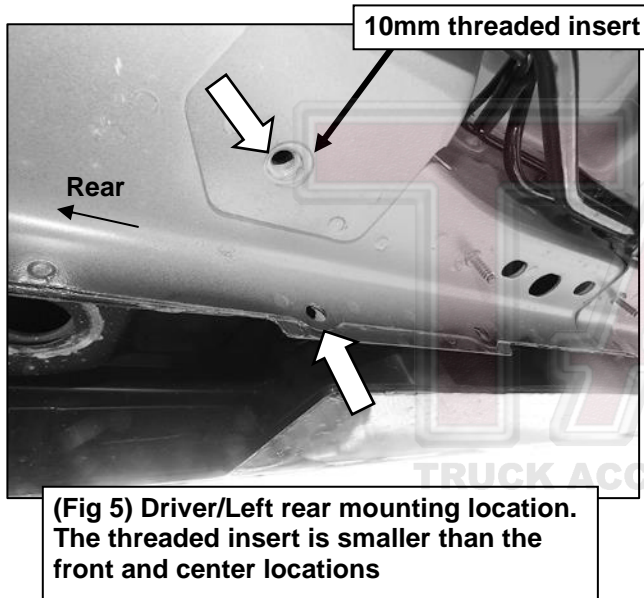
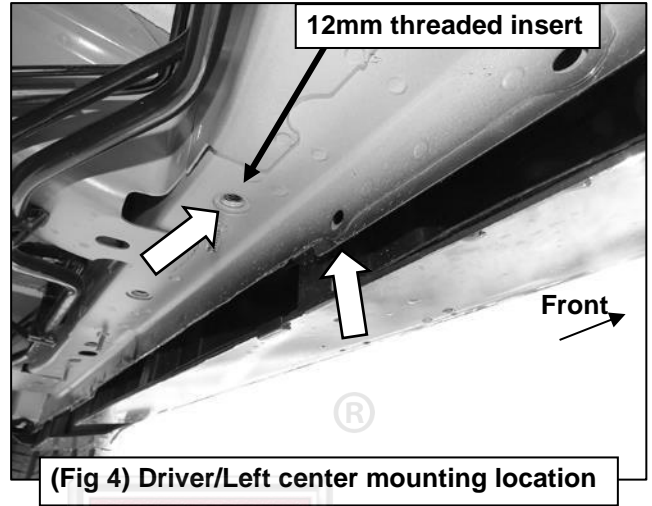
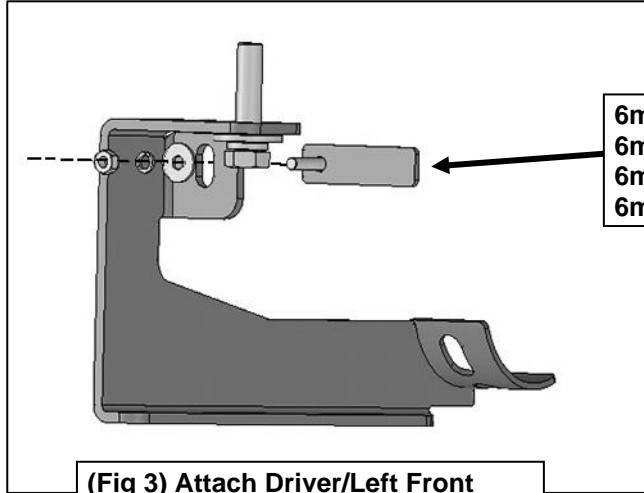

Passenger Side Installation Pictured

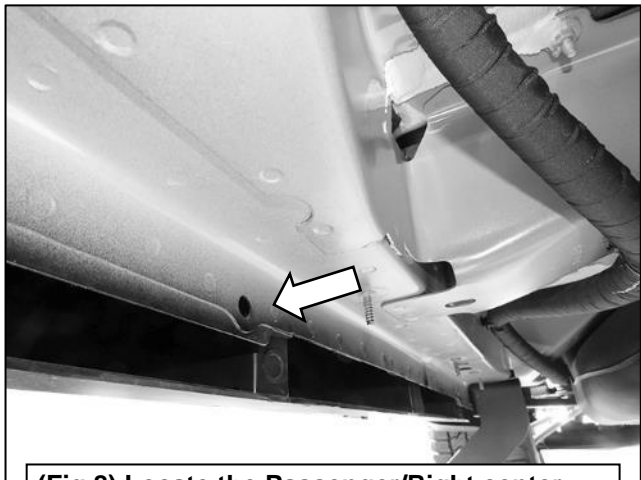

(Fig 8) Locate the Passenger/Right center mounting location. Line up the top of the Passenger/Right Center Mounting Bracket to the hole in the pinch trim. Mark the top slot for drilling. Use a 1/2" drill bit, not included

(9-A) Select Insert Tool and (1) Insert. Thread Insert onto end of Insert Tool. Hand tighten only, do not tighten hex bolt

(9-B) Firmly hold assembly and push Insert into drilled hole.

(9-C) Hold Tool Assembly up tight in body panel. Turn hex bolt in Tool clockwise to expand insert in body panel. Remove Tool once Insert is fully tightened. Do not overtighten or Insert may be damaged.

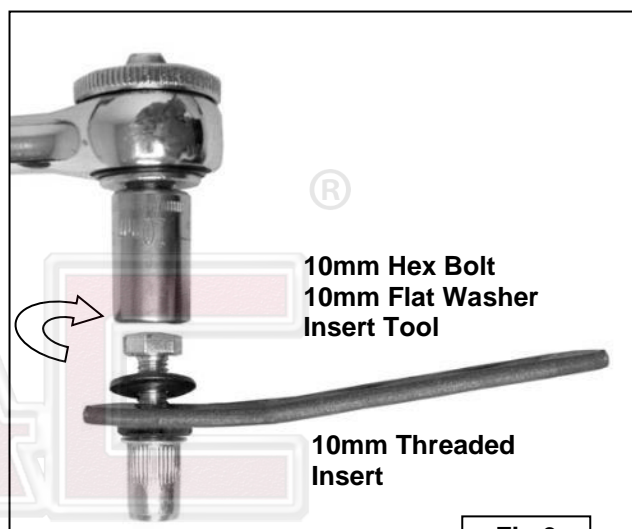
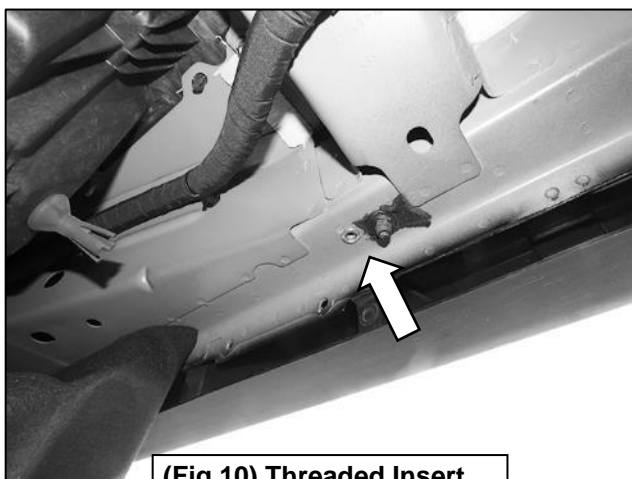

Fig 9



(Fig 10) Threaded Insert installed in the floor panel