



INSTALLATION INSTRUCTIONS

3" SIDEBAR TEXTURE BLACK

**2011-2021 Grand Cherokee(Incl.22 WK & Excl. Limited X/High
Altitude/Summit/SRT/SRT8/ Trackhawk/ Trailhawk/ L model)**

PART# 3S-J113T

PARTS LIST:

1	Driver/Left Sidebar	6	12mm Serrated Flange Nuts
1	Passenger/Right Sidebar	12	8-1.25mm x 25mm Hex Bolts
3	Driver/Left Mounting Brackets	12	8mm x 24mm x 2mm Flat Washers
3	Passenger/Right Mounting Brackets	12	8mm Lock Washers
6	12-1.75mm x 40mm Bolt Plates	12	6-1.0mm x 25mm Hex Bolts
6	12mm Plastic Retainers	24	6mm x 18mm OD x 1.6mm Flat Washers
6	12mm x 24mm OD x 2.5mm Flat Washer	12	6mm Nylon Lock Nuts

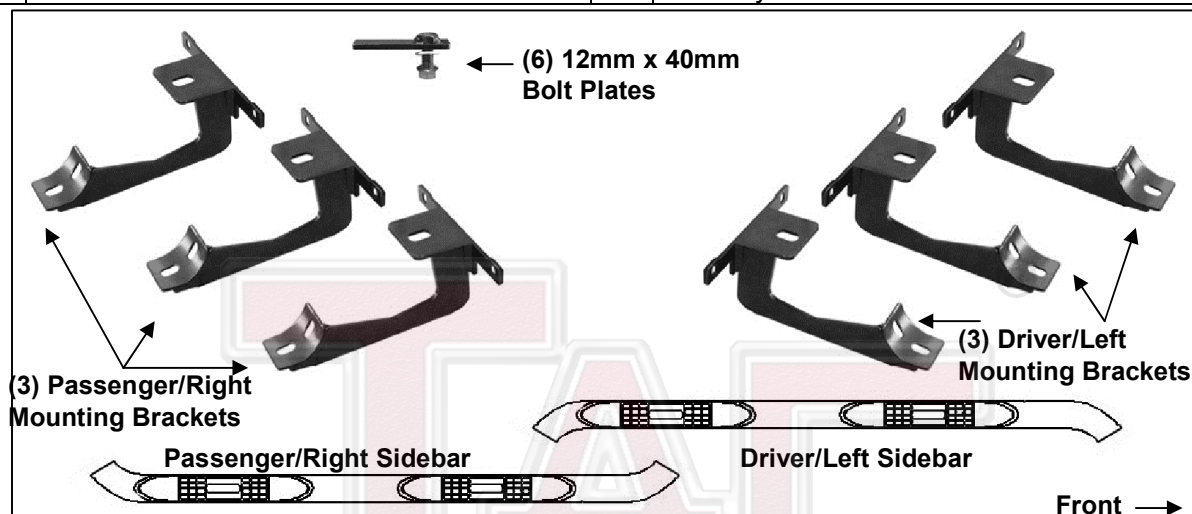
**PROCEDURE:**

- REMOVE CONTENTS FROM BOX. VERIFY ALL PARTS ARE PRESENT. READ INSTRUCTIONS CAREFULLY BEFORE STARTING INSTALLATION.**
- Starting at the passenger side front, locate the 3 pairs of (2) small holes in the pinch weld, **(Figures 1 & 2)**. Remove the rubber plug filling the oval hole in the bottom of the rocker panel directly in front of the (2) holes, **(Figure 3)**. Select (1) 12mm Bolt Plate and (1) 12mm Plastic Retainer, **(Figure 4A)**. Thread the Retainer part way onto the Bolt Plate. **NOTE:** The Retainer will help hold the Bolt Plate in position during Bracket installation. Insert the Bolt Plate into the hole and rotate 90-degrees to the slot, **(Figures 4B & 5)**. Thread the Retainer down until it is tight against the sheet metal.
- Select (1) passenger side Mounting Bracket. Hang the Bracket from the Bolt Plate with (1) 12mm Flat Washer and (1) 12mm Flange Nut, **(Figures 6 & 7)**. Next, bolt the mounting plate on the Bracket to the front of the pinch weld with (2) 6mm x 25mm Hex Bolts, (4) 6mm Flat Washers and (2) 6mm Nylon Lock Nuts, **(Figure 6)**. **NOTE:** Insert 6mm Hex Bolts with Flat Washers through the back of the pinch weld first, and then out through the Bracket. **IMPORTANT:** The passenger side of the vehicle may have a wiring harness attached behind the pinch weld, **(Figure 7)**. Remove the hex nuts and drop the harness down before installing the Brackets. 6mm Hex Bolts install from the inside first, then through the Bracket to clear the harness, **(Figure 8)**. Snug but do not fully tighten hardware at this time.
- Repeat **Steps 2 – 3** for center and rear Mounting Bracket installation.
- Select the passenger/right Sidebar and carefully place it in position on the (3) Mounting Brackets. Line up the threaded holes in the Sidebar with the slots in the Brackets and bolt it in place with the included (6) 8mm x 25mm Hex Bolts, (6) 8mm Lock Washers and (6) 8mm Flat Washers, **(Figure 9)**. Snug all hardware but do not tighten at this time.
- Adjust and level the Sidebar and tighten all hardware. Reinstall wire harness, **(Step 3)**, if equipped.
- Repeat **Steps 2 – 6** for passenger/right Sidebar installation.
- Do periodic inspections to the installation to make sure that all hardware is secure and tight.

To protect your investment, wax this product after installing. Regular waxing is recommended to add a protective layer over the finish. Do not use any type of polish or wax that may contain abrasives that could damage the finish.

For stainless steel: Aluminum polish may be used to polish small scratches and scuffs on the finish. Mild soap may be used also to clean the Sidebar.

For gloss black finishes: Mild soap may be used to clean Sidebar.

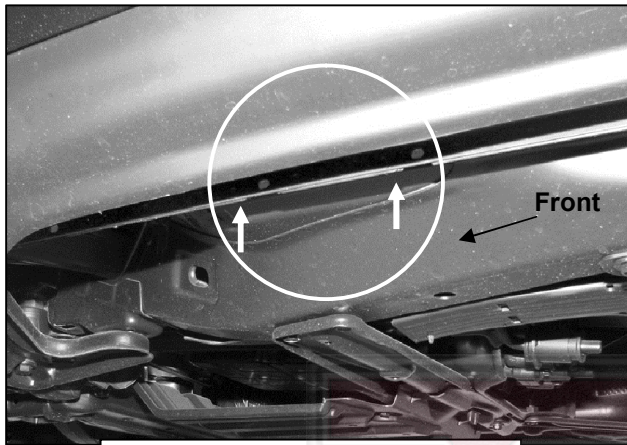

(Fig 1) Driver side front pictured

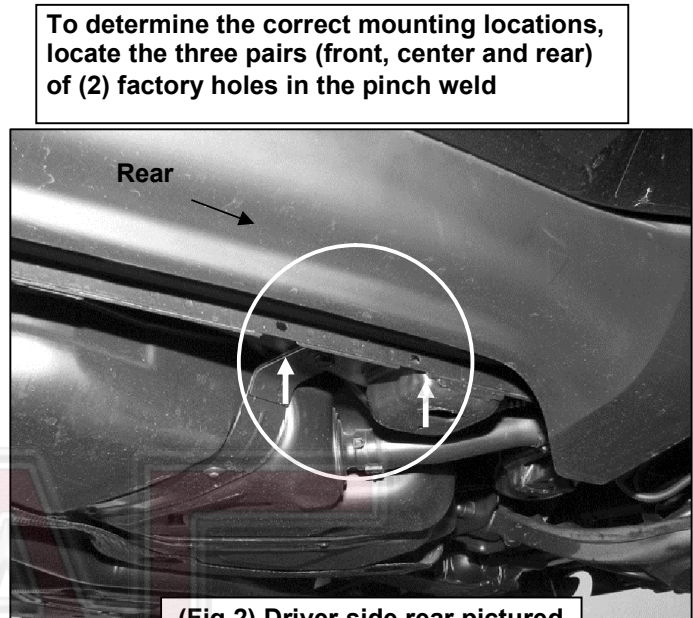

(Fig 2) Driver side rear pictured

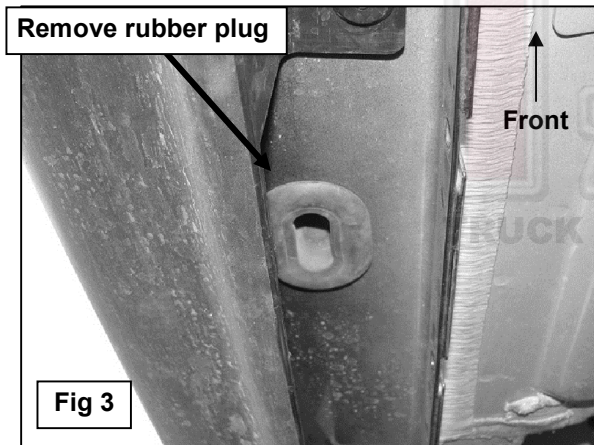
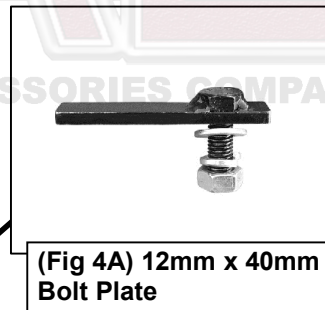

Fig 3



(Fig 4A) 12mm x 40mm Bolt Plate

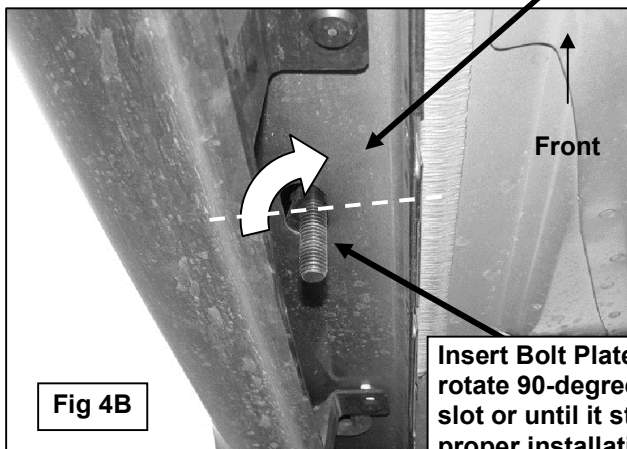
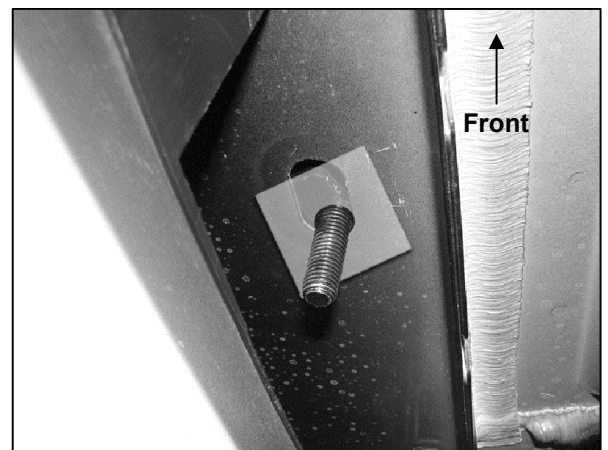

Fig 4B

Insert Bolt Plates then rotate 90-degrees to the slot or until it stops for proper installation



(Fig 5) Thread Plastic Retainer onto Bolt Plate

Passenger Side Installation Pictured

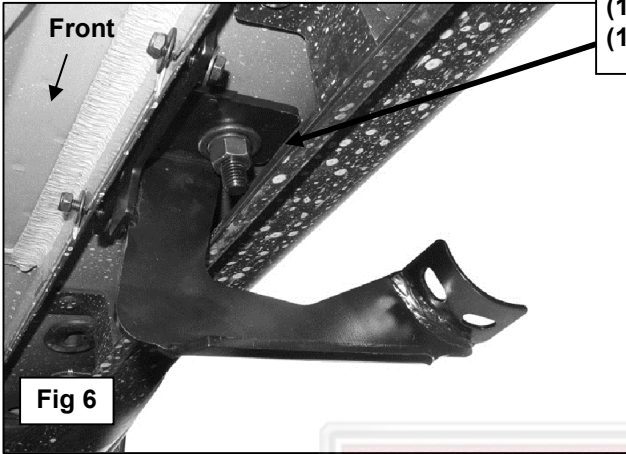

- (1) 12mm Bolt Plate
- (1) 12mm Flat Washer
- (1) 12mm Locking Flange Nut

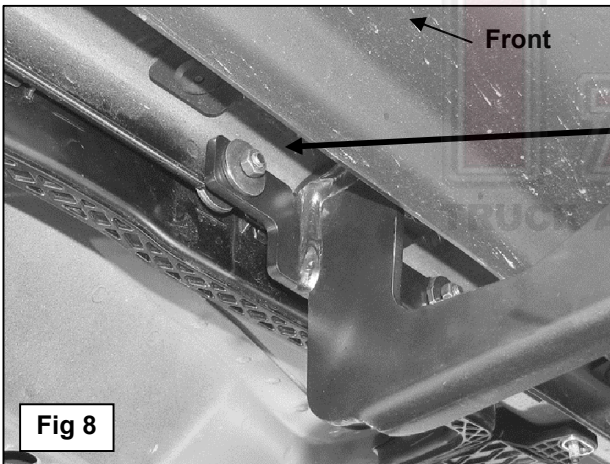
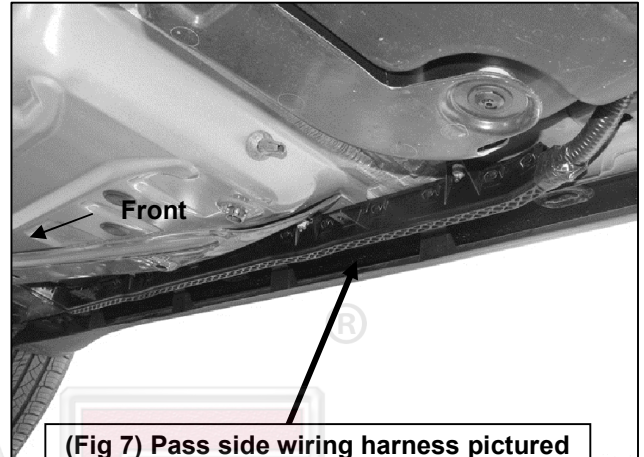

- Bolt Mounting Bracket to outside of pinch weld with:**
- (2) 6mm x 25mm Hex Bolts
 - (4) 6mm x 18mm Flat Washers
 - (2) 6mm Nylon Lock Nut
- Insert Hex Bolts from inside to outside**

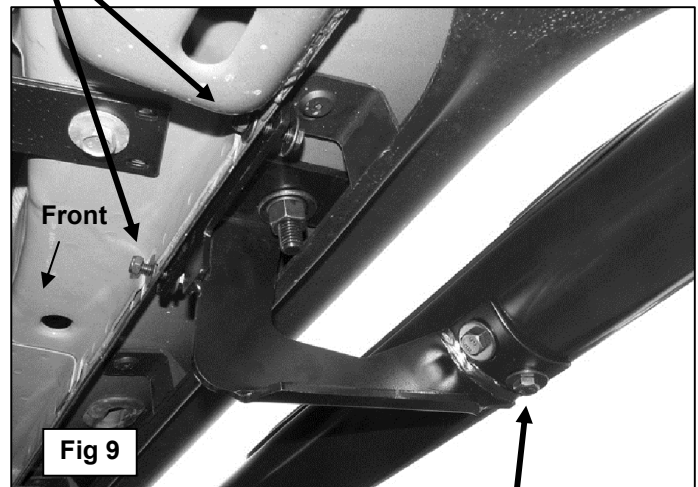

- 8mm x 25mm Hex Bolt
- 8mm Lock Washer
- 8mm Flat Washer

