



INSTALLATION INSTRUCTIONS

3 INCH SIDEBAR

2019-2023 FORD RANGER SUPERCREW CAB 4DR

PART# 3S-F1212

TRUCK ACCESSORIES COMPANY

PARTS LIST:

| | | | |
|---|-------------------------------|----|--------------------------------|
| 1 | Driver/Left Sidebar | 12 | 10-1.5mm x 25mm Hex Bolts |
| 1 | Passenger/Right Sidebar | 12 | 10mm Lock Washers |
| 2 | Front Mounting Brackets | 12 | 10mm x 27mm x 3mm Flat Washers |
| 4 | Center/Rear Mounting Brackets | 12 | 8-1.25mm x 25mm Combo Bolts |

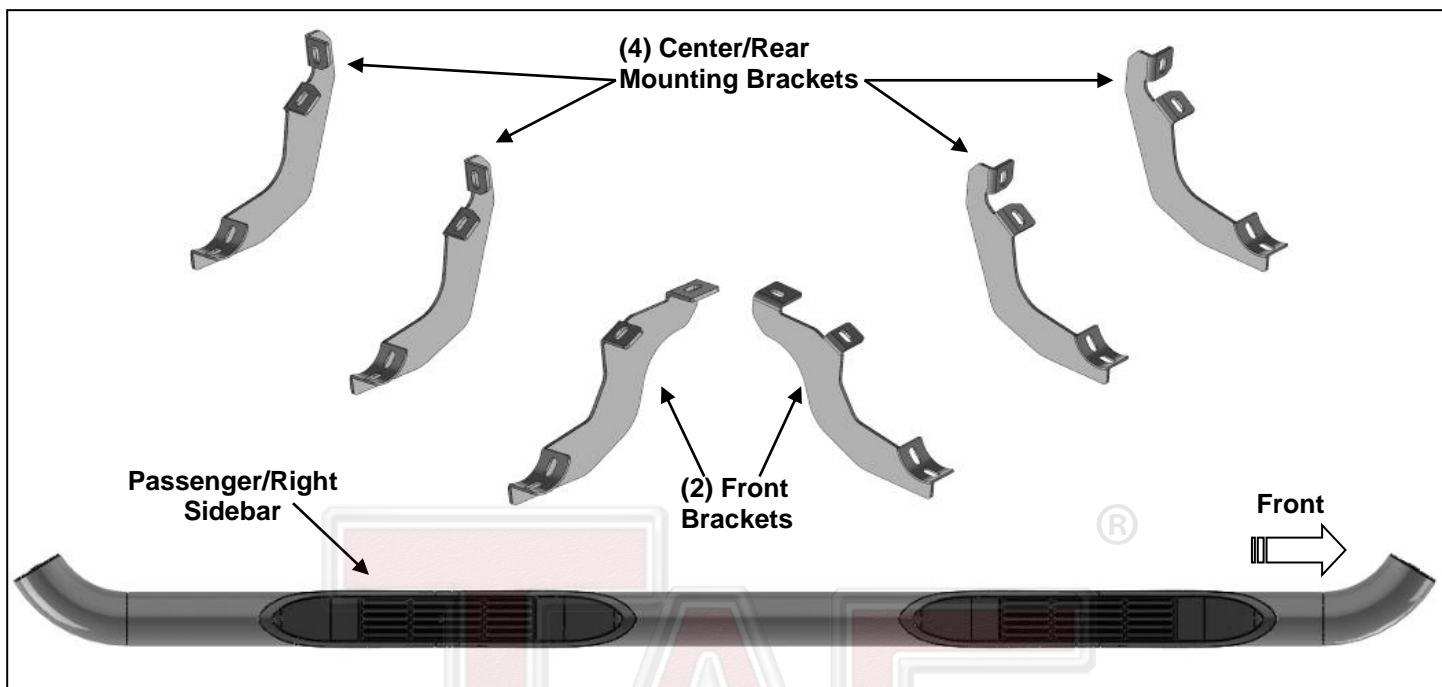

PROCEDURE:

1. REMOVE CONTENTS FROM BOX. VERIFY ALL PARTS ARE PRESENT. READ INSTRUCTIONS CAREFULLY BEFORE STARTING INSTALLATION.
2. Starting from underneath the Passenger/Right side inner rocker panel, locate the threaded mounting holes on the rocker panel, **(Figure 1)**. Remove the plastic plugs covering the mounting holes. Select the Passenger/Right Front Mounting Bracket, **(Figure 2)**. Attach with (2) 10mm Hex Bolts, (2) 10mm Lock Washers and (2) 10mm Flat Washers, **(Figures 2 & 3)**. Do not tighten hardware at this time.
3. Locate the Center threaded mounting holes. Select (1) Center/Rear Mounting Bracket. Attach with (2) 10mm Hex Bolts, (2) 10mm Lock Washers and (2) 10mm Flat Washers, **(Figures 4—6)**. Do not tighten hardware at this time.
4. Repeat **Step 3** to install Rear Mounting Bracket, **(Figures 5 & 7)**.
5. Unwrap the Passenger/Right Sidebar. Attach Sidebar to the mounting brackets with (6) 8mm Combo Bolts. Do not tighten hardware at this time, **(Figures 8—11)**. **IMPORTANT:** Do not slide or rotate Sidebar on cradles, or damage to the finish may result.
6. Level and adjust Sidebar and tighten all hardware.
7. Repeat **Steps 2—6** for Driver/Left side installation.
8. Do periodic inspections to the installation to make sure that all hardware is secure and tight.

To protect your investment, Do not use any type of polish or wax that may contain abrasives that could damage the finish. **For Stainless Steel,** Aluminum polish may be used to polish small scratches and scuffs on the finish. Mild soap may be used to clean the Sidebar.

Passenger/Right side Installation Pictured

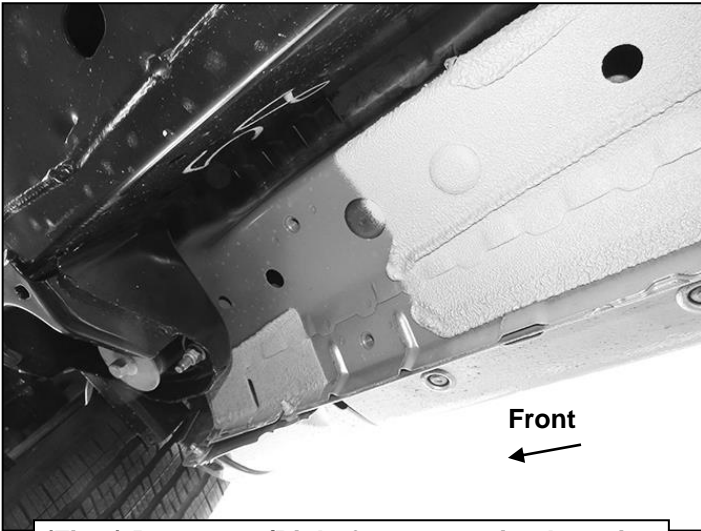

(Fig 1) Passenger/Right front mounting Location

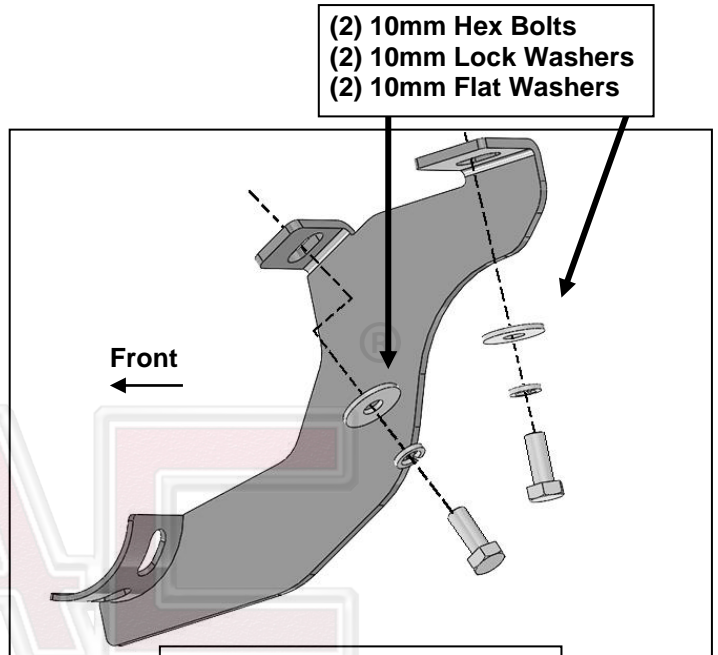

- (2) 10mm Hex Bolts
- (2) 10mm Lock Washers
- (2) 10mm Flat Washers

(Fig 2) Passenger/Right Front Mounting Bracket installation

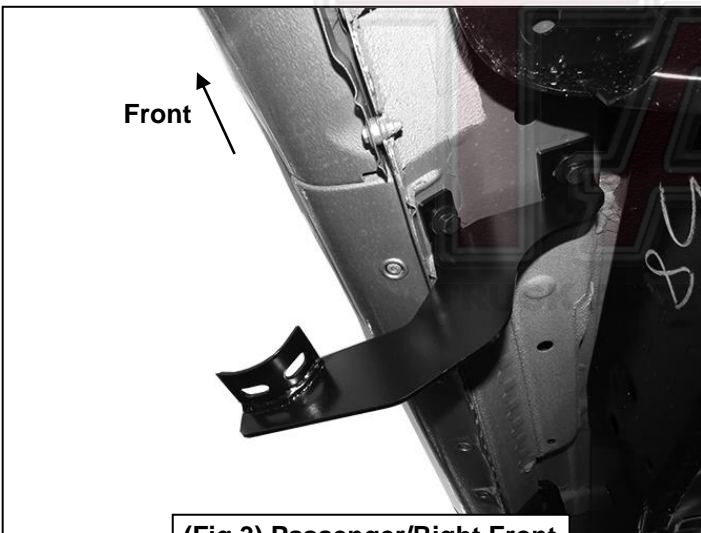

(Fig 3) Passenger/Right Front Mounting Bracket attached

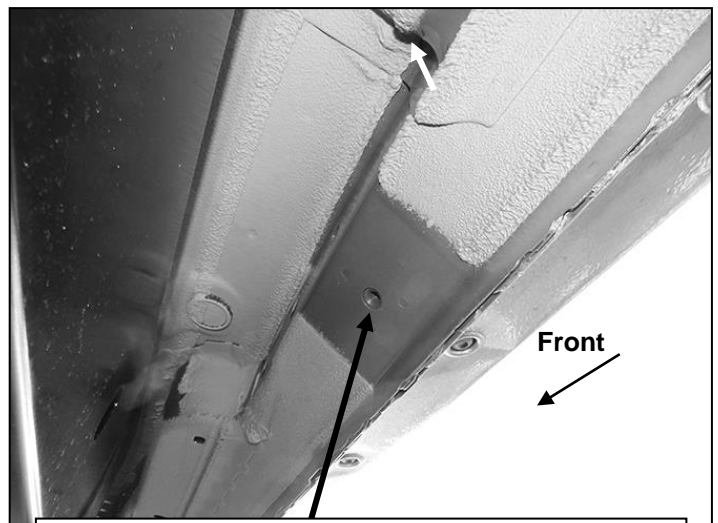

(Fig 4) Passenger/Right Center mounting location

Passenger/Right side Installation Pictured

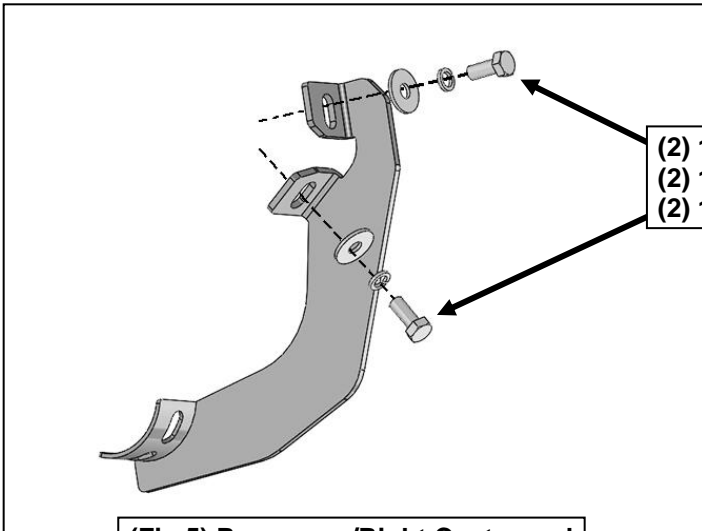

(Fig 5) Passenger/Right Center and Rear mounting Bracket installation

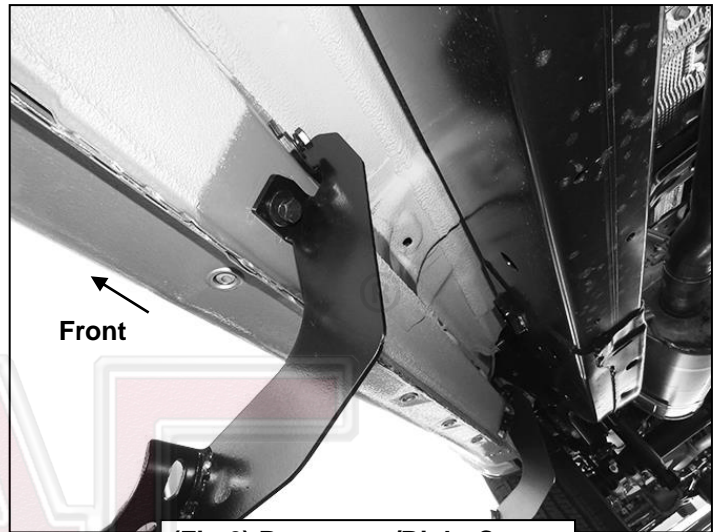

(Fig 6) Passenger/Right Center Mounting Bracket installed



(Fig 7) Passenger/Right Rear Mounting Bracket installed

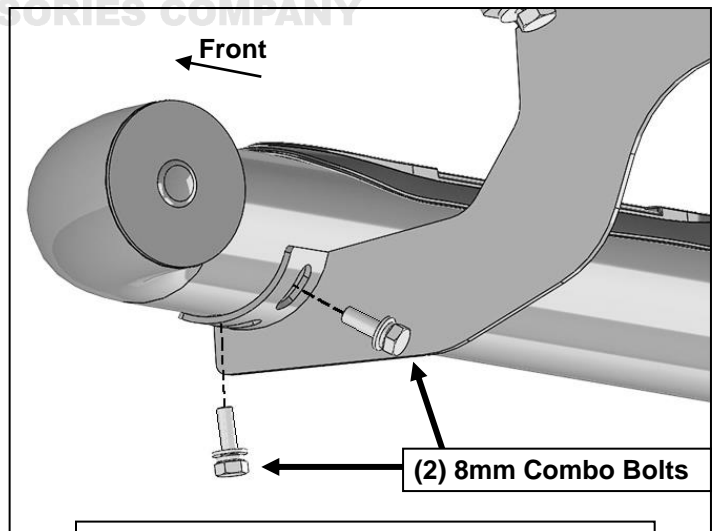

(Fig 8) Passenger/Right Sidebar installation

Passenger side Installation pictured

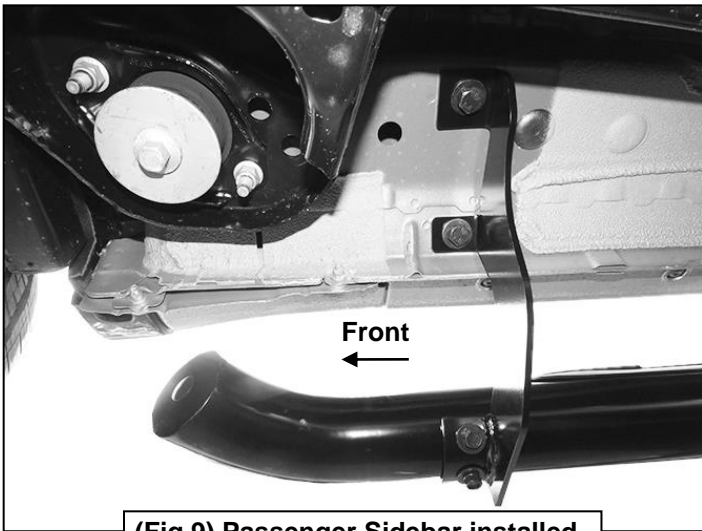

(Fig 9) Passenger Sidebar installed on Front Mounting Bracket



(Fig 10) Passenger Sidebar installed on Center Mounting Bracket

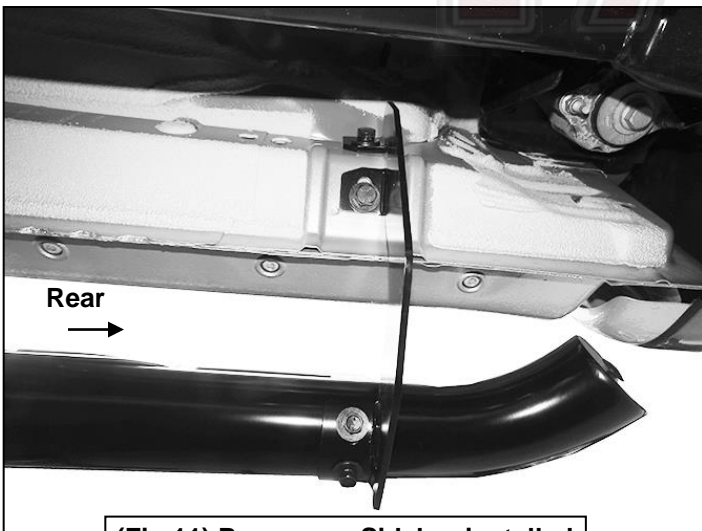

(Fig 11) Passenger Sidebar installed on Rear Mounting Bracket