



INSTALLATION INSTRUCTIONS

3" SIDEBARS BODY BOLT MOUNT

1999-2018 SILVERADO/SIERRA 1500 REGULAR CAB

1999-2019 SILVERADO/SIERRA 25-3500 REGULAR CAB

(EXCL. C/K "CLASSIC")

PART#3S-C1102

IMPORTANT ALERT: GM uses a very strong thread-locking compound on all body bolts. Use of an air assisted impact ratchet can cause damage to the threads on factory body mount bolts and the internal nut assembly because of this thread locking compound.

We only recommend the use of hand tools to slowly remove and reinstall body mount bolts on all GM vehicles.

PROCEDURE:

CRITICAL INFORMATION: If during the removal process, it becomes increasingly difficult to unscrew the body mount bolt with hand tools, tighten the bolt several rotations to clear the thread locking compound from the threads, then reverse direction and continue to unscrew until the body mount bolt is out. Repeat this process as necessary on all GM body mount bolts. Use of an appropriate anti-seize compound is highly recommended for re-installation. Tighten body mount bolt to factory torque specifications for your particular model year.

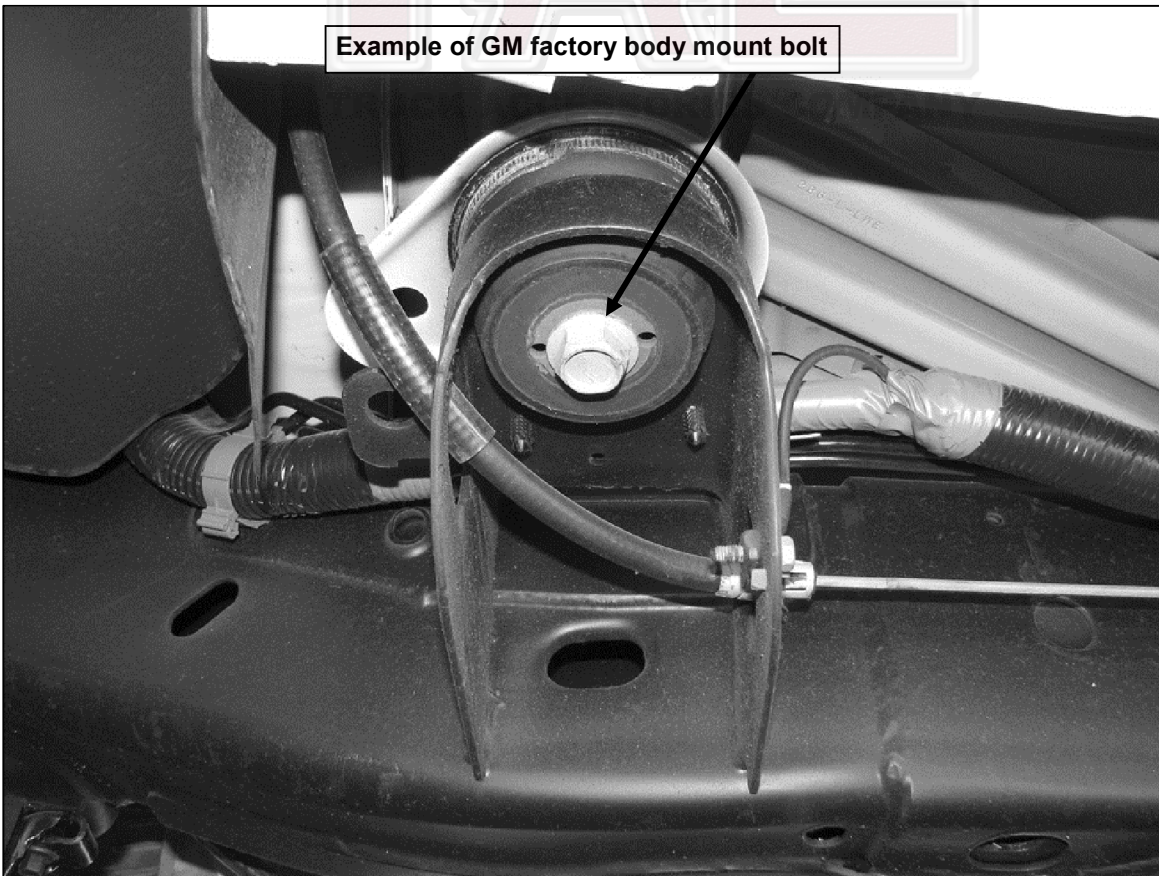

PARTS LIST:

Qty	Description	Qty	Description
1	Driver/Left Side Bar	1	Passenger/Right Rear Mounting Bracket
1	Passenger/Right Side Bar	4	1/2" x 1-1/2" OD x 1/8" Large Flat Washers
1	Driver/Left Front Mounting Bracket	4	1/2" Lock Washers
1	Passenger/Right Front Mounting Bracket	4	1/2" x 2" Hex Bolts
1	Driver/Left Rear Mounting Bracket		

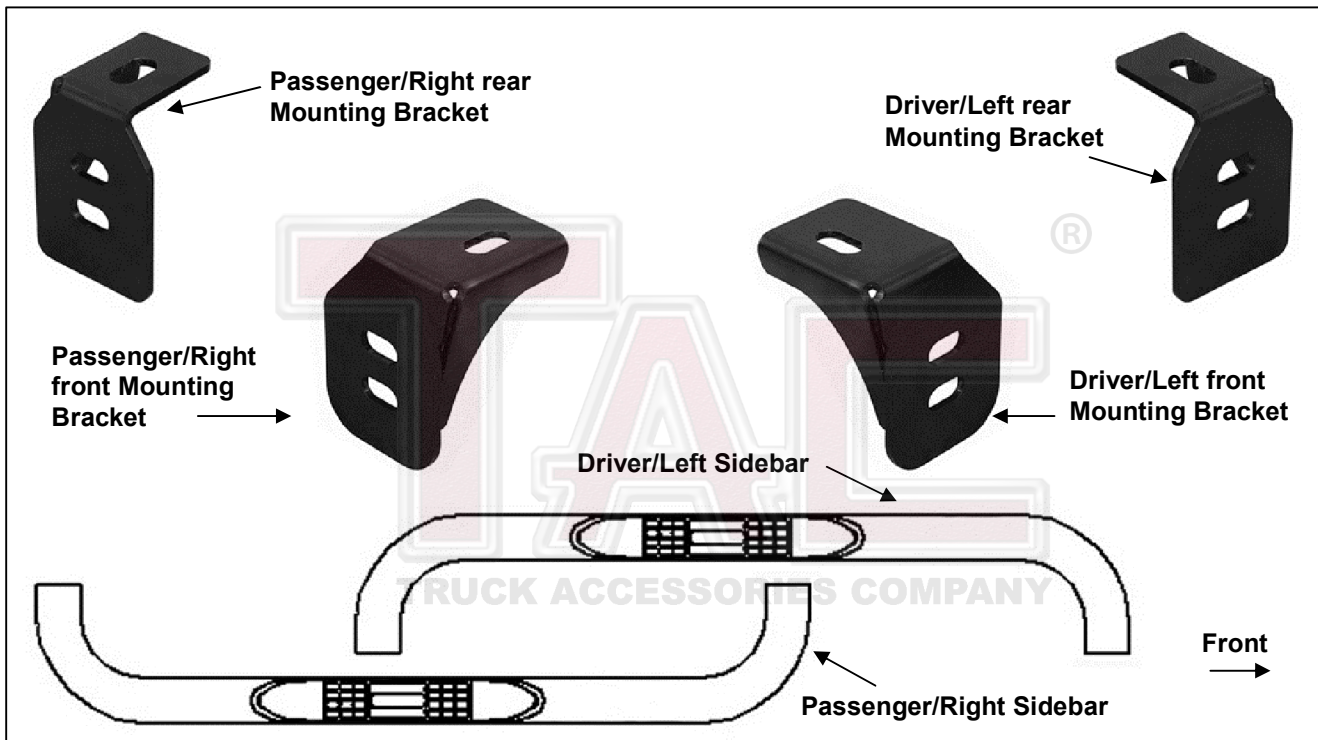

PROCEDURE:

REMOVE CONTENTS FROM BOX. VERIFY ALL PARTS ARE PRESENT. READ INSTALLATION INSTRUCTIONS CAREFULLY BEFORE STARTING INSTALLATION.

1. Start installation on the front, passenger side of the vehicle. Remove the factory front body mount bolt, **(Figure 1)**.
2. Select the passenger side front Mounting Bracket, **(Figure 2)**. Insert the body mount bolt through the Mounting Bracket, factory washer and up into the mount, **(Figure 3)**. Snug but do not fully tighten the body bolt at this time. **VERY IMPORTANT! To prevent unnecessary noise, adjust the position of all Mounting Brackets so that once tightened, the Mounting Brackets cannot come in contact with the factory steel body mount bracket.**
3. Move toward the rear of the vehicle. Remove the factory body mount bolt as described in **Step 1**. Select the driver side Rear Mounting Bracket, **(Figure 4)**. Bolt the rear Mounting Bracket in place as previously described in **Step 2, (Figure 5)**.
4. With assistance, position the Sidebar up to the front and rear Mounting Brackets. **IMPORTANT:** There are two slots in each Mounting Bracket, **(Figure 4)**. Select the appropriate mounting position:

1999-2013 1500: Use the lower mounting slots.

2014-on 1500: Use the upper mounting slots.

1999-2015 25-3500: Use the lower mounting slots

Attach the Sidebar to the Brackets with the included (2) 1/2" x 2" Hex Bolts, (2) 1/2" Lock Washers and (2) 1/2" Flat Washers, (**Figures 6 & 7**). Do not tighten hardware at this time.

5. Level and adjust the Sidebar, tighten all hardware and check all mounting locations for clearance between factory steel body mount brackets and Mounting Brackets. Once satisfied with fit, tighten all hardware.
6. Repeat **Steps 1—5** for driver Sidebar installation.
7. Do periodic inspections to the installation to make sure that all hardware is secure and tight.

To protect your investment, wax this product after installing. Regular waxing is recommended to add a protective layer over the finish. Do not use any type of polish or wax that may contain abrasives that could damage the finish.

For stainless steel: Aluminum polish may be used to polish small scratches and scuffs on the finish. Mild soap may be used also to clean the Sidebar.

For gloss black finishes: Mild soap may be used to clean the Sidebar.

Passenger side installation pictured

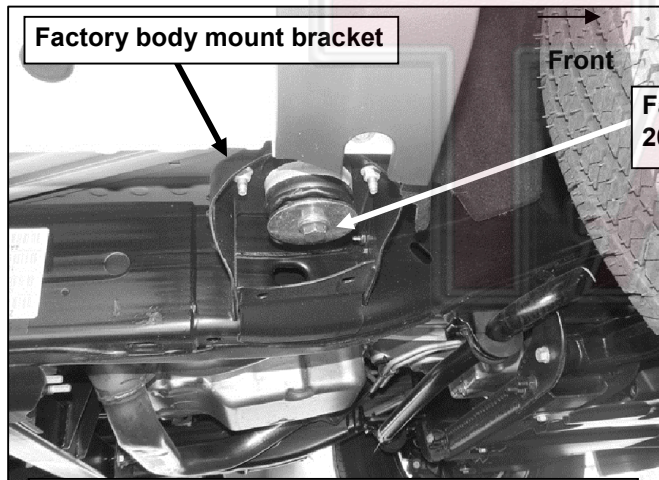

(Fig 1) Passenger/right front Mounting Location



(Fig 2) Passenger/right front Bracket

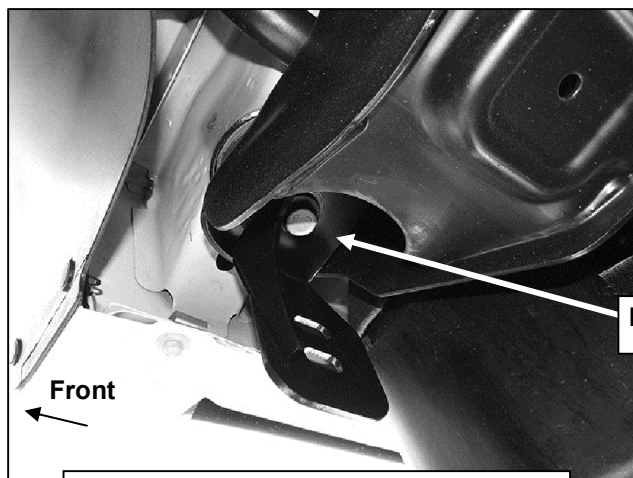

(Fig 3) Passenger/right front Bracket

Passenger side installation pictured

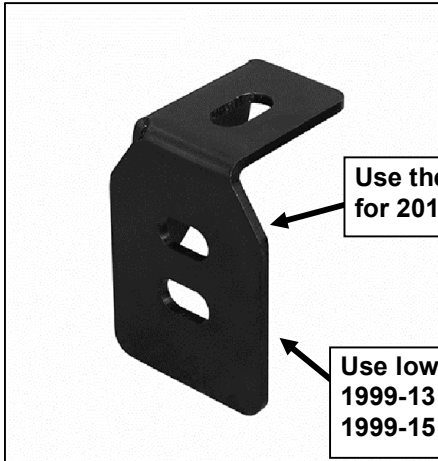

Use the top mounting position
for 2014-on 1500 models only

Use lower mounting slots for
1999-13 1500 models
1999-15 25-3500 models

(Fig 4) Passenger/right rear Bracket

Determine correct mounting slots to use:
1999-2013 1500: Use the lower mounting slots.
2014-on 1500: Use the upper mounting slots.
1999-2015 25-3500: Use the lower mounting slots

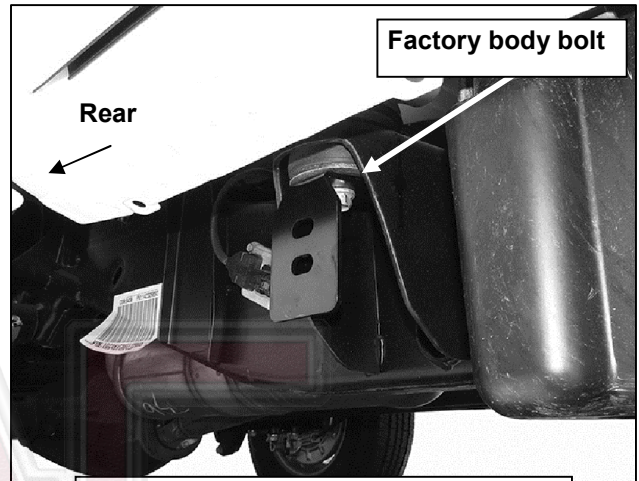

Factory body bolt

Rear

(Fig 5) Passenger/right rear Bracket



Front

(Fig 6) Passenger/right front Bracket

1/2" x 2" Hex Bolt
1/2" Lock Washer
1/2" Flat Washer

Factory body bolt

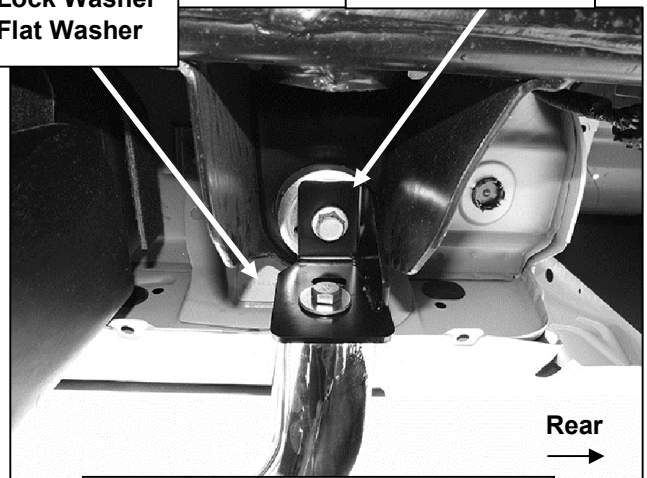

Rear

(Fig 7) Passenger/right rear Bracket



Complete Installation