



## **INSTALLATION INSTRUCTIONS**

**3" BULL BAR**

**07-13 CHEVY AVALANCHE**

**07-14 CADILLAC ESCALADE 1500/ESV/EXT**

**2007-18 CHEVY SILVERADO1500/GMC SIERRA1500**

**(INCL. 2019 SILVERADO 1500 LD)**

**2007-20 TAHOE/SUBURBAN/YUKON/YUKON XL**

**PART#3B-C100T**

**PARTS LIST:**

1	Bull Bar	6	12mm x 24mm OD x 2.5mm Flat Washers
1	Driver/Left Mounting Bracket	6	12-1.75mm Nylon Lock Nuts
1	Passenger/Right Mounting Bracket	4	10-1.50mm x 30mm Hex Bolts
2	12-1.75mm x 30mm Double Bolt Plates	8	10mm x 27mm OD x 3mm Flat Washers
2	12-1.75mm x 35mm Single Bolt Plates	4	10-1.50mm Nylon Lock Nuts

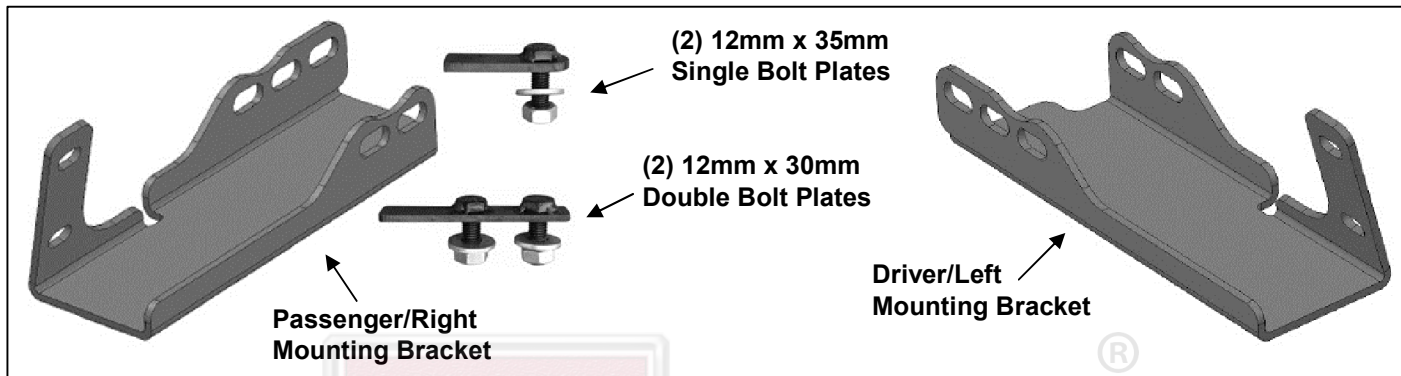

**PROCEDURE:**

**REMOVE CONTENTS FROM BOX AND VERIFY ALL PARTS ARE PRESENT. READ INSTRUCTIONS CAREFULLY. CUTTING MAY BE REQUIRED. INSTALLATION MAY INTERFERE WITH FRONT MOUNTED SENSORS. NOTE:** It may be necessary to remove/relocate front license plate and license plate bracket. It is not required, but strongly recommended. If local/state law requires a front license plate, license plate relocation kit is available.

1. Start installation from under the front of the vehicle. Determine if the vehicle is equipped with tow hooks.

**IMPORTANT:** Tow hooks cannot be reinstalled with the Bull Bar.

**Tow Hook equipped vehicles:**

Remove the factory tow hook from the end of each frame channel, (**Figure 1**). Skip to **Step 2** if tow hooks were accessible and have been removed. **NOTE:** Tow hooks on 2014-on models may be difficult to remove and assistance is highly recommended on these models. The following info only applies to the 2014-on models.

- a. On models with factory fog lights, unplug both lights. Move all wiring harnesses away from bumper.
- b. Open the hood and remove the cover between the top of the radiator and the grille. Remove the bolts attaching the bottom of the grille if attached to the cross member. Remove the grille.
- c. On 2014-15 models, from behind the bumper, release the clips and hardware to remove the plastic body panel, (facia), on top of the bumper between the bottom of the grille and the top of the bumper, (**Figure 2**).
- d. Remove the outer bumper supports on each side of the frame.
- e. Place blocks or jack stands under the front bumper to support it during mounting bolt removal. Once the bumper has been safely supported, remove the factory bumper bolts attaching the bumper to the inner bumper bracket bolted to the end of the frame, (**Figures 2 & 3**). **WARNING!** Assistance is required to hold the bumper in place during bolt removal to prevent the bumper from falling. Carefully slide the bumper assembly with brackets off of the ends of the frame.
- f. Once bumper has been removed, remove both tow hooks.
- g. Reattach the bumper, facia panel if equipped and grille after both tow hooks have been removed and the openings have been checked for Bracket clearance. Trim around openings as required for Bracket clearance.
- h. Tighten all factory bumper hardware at this time.
- i. Proceed to **Step 2**.

**Vehicles without tow hooks:**

- a. Cut out the indented area in both sides of the plastic bumper insert to clear the Brackets as pictured, **(Figures 4 & 5)**. **IMPORTANT:** Make several small cuts for best fit. Do not cut through the top edge of the panel. **NOTE:** On 2014-15 models, the plastic panel is held in place with several small screws. The screws at the top corners are difficult to impossible to reach and remove without damaging the cover with the bumper in place. If you prefer to remove the panel to cut out the openings, it will be easier to remove the bumper assembly with the plastic panel attached.
- b. Reattach the bumper assembly, (if removed), facia and grille once openings have been cut out and checked for clearance. Tighten all factory bumper hardware at this time.
2. Select the driver side Mounting Bracket. Insert the Bracket through the opening in the bumper, **(Figure 5)**. Trim the plastic as required to clear the Brackets.
3. Line up the holes in the Bracket with the holes in the end of the frame channel for the tow hook, **(Figure 6)**. Select (1) 12mm Double Bolt Plate, **(Figure 7)**. Insert the Bolt Plate into the end of the frame, through the (2) holes in the side of the frame and out through the Bracket, **(Figures 8 & 9)**. Secure the Bracket to the Bolt Plate with (2) 12mm Flat Washers and (2) 12mm Nylon Lock Nuts. Snug but do not fully tighten hardware at this time.
4. Repeat **Step 3** to install the 12mm x 35mm Single Bolt Plate, **(Figure 10)**, into the remaining hole in the other side of the frame channel and Bracket, **(Figures 11 & 12)**.
5. **IMPORTANT:** The Brackets are designed with (2) mounting positions to fit multiple models and model years. Most Silverado/Sierra models will use the "back" mounting position with the Brackets pushed in to install the Bull Bar closer to the bumper, **(Figure 13)**. Tahoe, Yukon and Suburban models may require the forward mounting position to move the Bull Bar forward or to provide more clearance for accessory lights, **(Figure 14)**.
6. Repeat **Steps 2—5** to install the passenger side Mounting Bracket.
7. With assistance, hold the Bull Bar up in position on the outside of the Mounting Brackets. Bolt the Bull Bar to the Brackets with (4) 10mm x 30mm Hex Bolts, (8) 10mm Flat Washers and (4) 10mm Nylon Lock Nuts, **(Figure 15)**. Do not tighten hardware at this time.
8. Check the Bull Bar alignment with the vehicle and for clearance between the Bull Bar and the bumper. If Bull Bar is too close to or touching bumper, remove the Bull Bar and reinstall the Brackets in the "forward" position away from the bumper, **(Figure 14)**. Adjust as required then fully tighten all hardware at this time.
9. Do periodic inspections to the installation to make sure that all hardware is secure and tight.

**To protect your investment**, wax this product after installing. Regular waxing is recommended to add a protective layer over the finish. Do not use any type of polish or wax that may contain abrasives that could damage the finish.

**For stainless steel:** Aluminum polish may be used to polish small scratches and scuffs on the finish. Mild soap may be used also to clean the Bull Bar.

**For gloss black finishes:** Mild soap may be used to clean the Bull Bar.

3" BULL BAR  
 2007-18 CHEVY SILVERADO1500/GMC SIERRA1500 (INCL. 2019 SILVERADO 1500 LD)  
 2007-19 TAHOE/SUBURBAN/YUKON/YUKON XL  
 2007-14 CADILLAC ESCALADE 1500/ESV/EXT  
 2007-13 CHEVY AVALANCHE

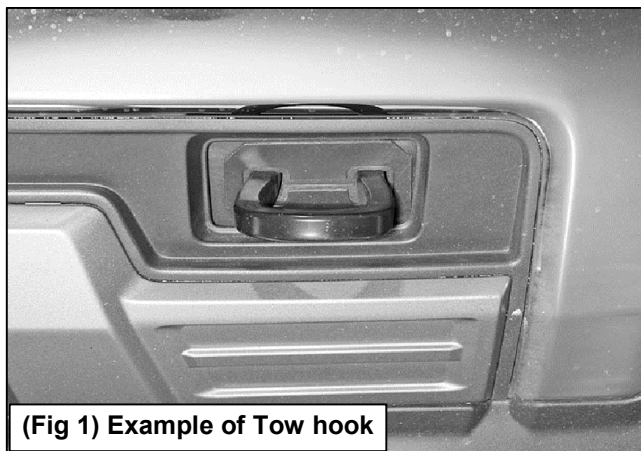

(Fig 1) Example of Tow hook

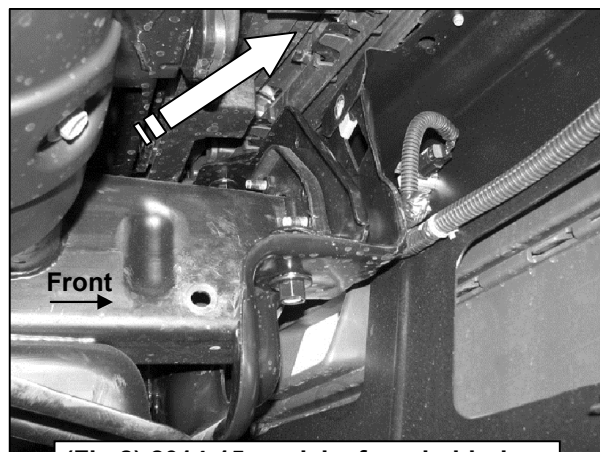

(Fig 2) 2014-15 models, from behind the bumper, remove the clips securing the fascia to the top of the bumper

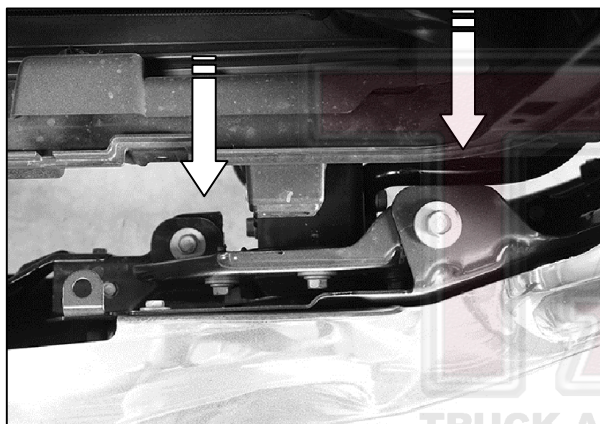

(Fig 3) 2016 model to show bumper bolt locations from above (arrows) with grille removed. 2014-15 models also remove plastic fascia panel to access bumper bolts as necessary

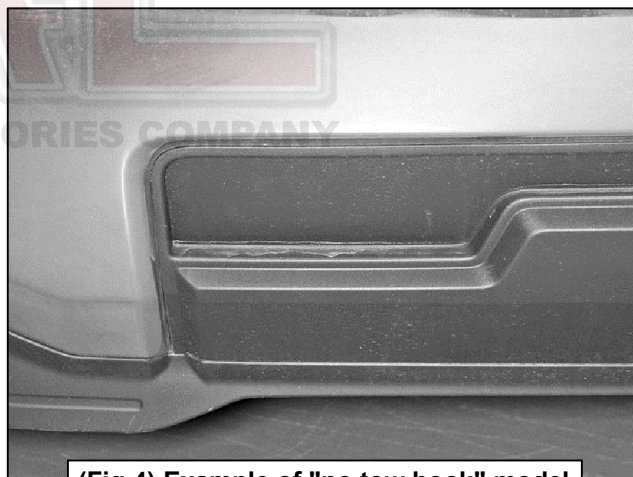

(Fig 4) Example of "no tow hook" model

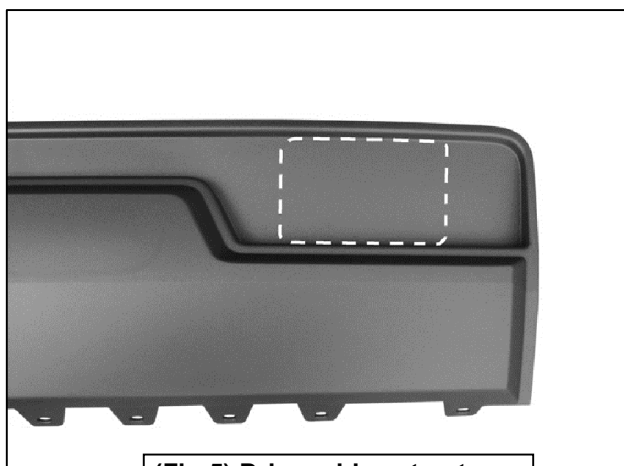

(Fig 5) Driver side cut out illustrated for reference only

**3" BULL BAR**  
 2007-18 CHEVY SILVERADO1500/GMC SIERRA1500 (INCL. 2019 SILVERADO 1500 LD)  
 2007-19 TAHOE/SUBURBAN/YUKON/YUKON XL  
 2007-14 CADILLAC ESCALADE 1500/ESV/EXT  
 2007-13 CHEVY AVALANCHE

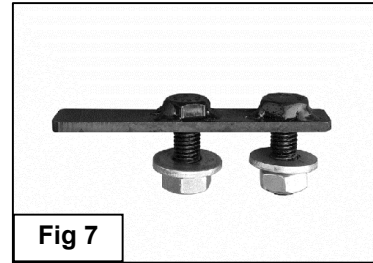
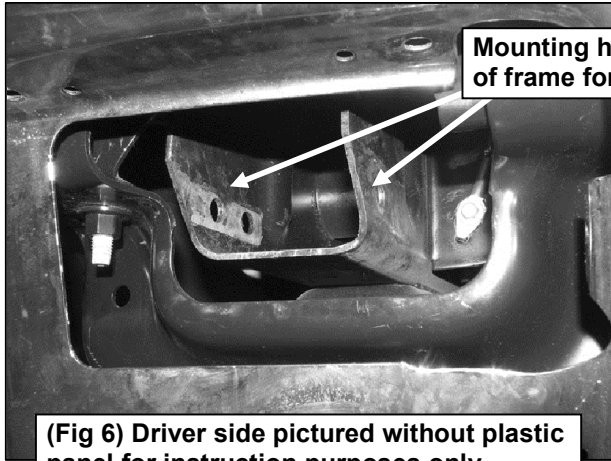

**12mm Double Bolt Plate  
 (2) 12mm Flat Washers  
 (2) 12mm Nylon Lock Nuts**

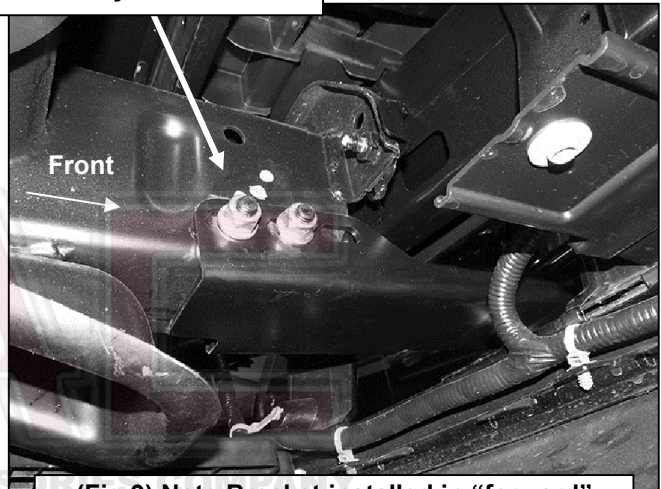
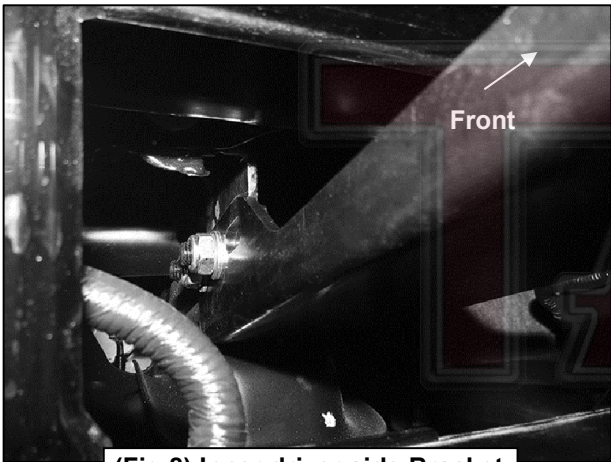

**(Fig 8) Inner driver side Bracket with Double Bolt Plate**

**(Fig 9) Note Bracket installed in "forward" position to move Bull Bar away from bumper**

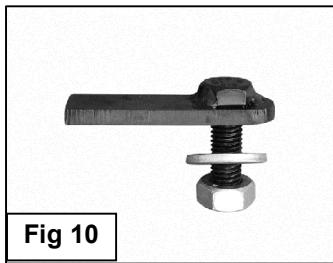

**12mm Single Bolt Plate  
 12mm Flat Washer  
 12mm Nylon Lock Nut**

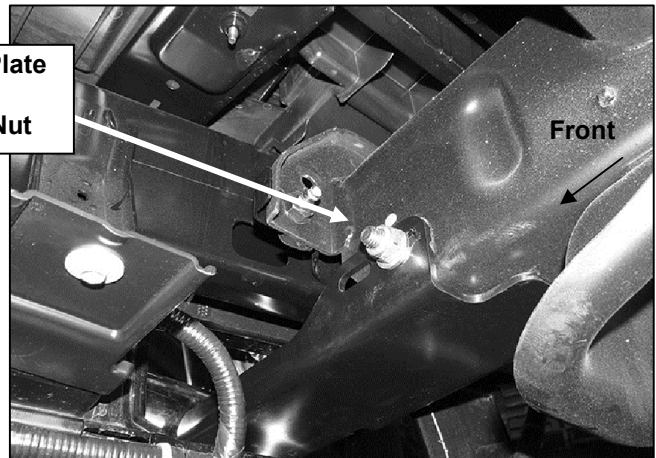

**(Fig 11) Passenger Bracket installed in "forward" position to move Bull Bar away from bumper**

**Driver Side Mounting Bracket Installation Pictured**

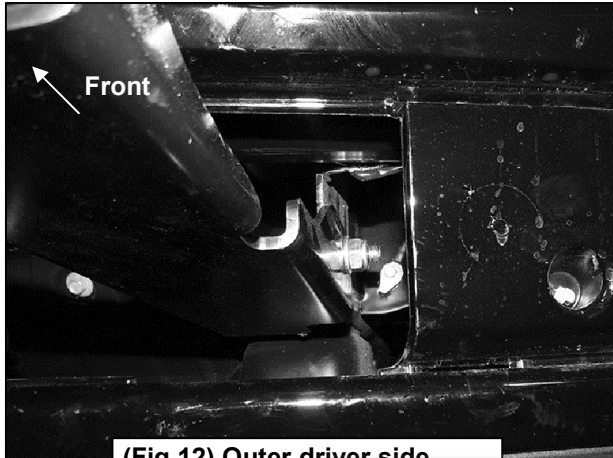

**(Fig 12) Outer driver side Bracket with Single Bolt Plate**

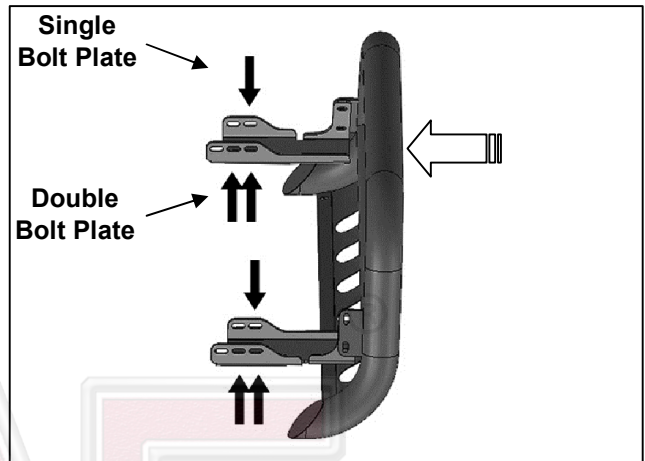

**(Fig 13) Typical Silverado/Sierra mounting position**

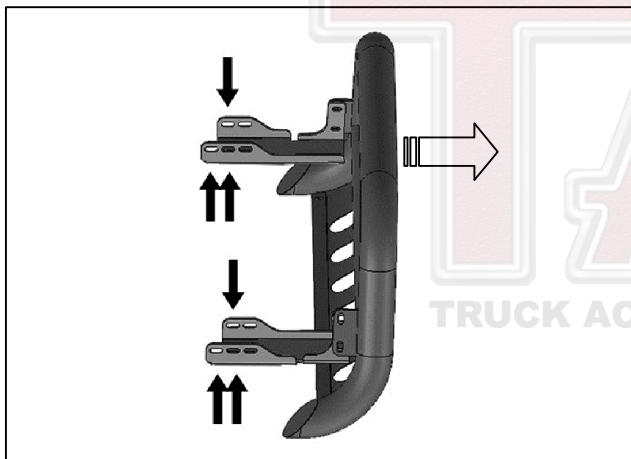

**(Fig 14) Typical Tahoe/Yukon and Suburban mounting position**

- (2) 10mm x 30mm Hex Bolts
- (4) 10mm Flat Washers
- (2) 10mm Nylon Lock Nuts

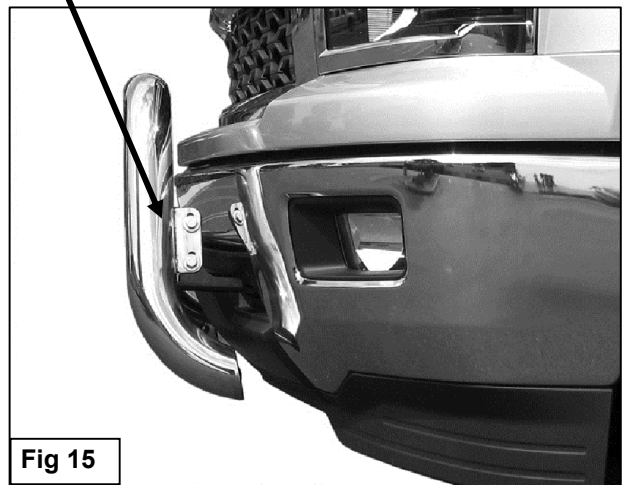

**Fig 15**

