



# INSTALLATION INSTRUCTIONS

**3INCH SIDEBARS**

**2022-2024 NISSAN PATHFINDER**

**PART#240970**

TRUCK ACCESSORIES COMPANY

**PARTS LIST:**

1	Driver/Left Sidebar	1	Passenger/Right Rear Mounting Bracket
1	Passenger/Right Sidebar	8	8mm x 25mm Hex Bolts
1	Driver/Left Front Mounting Bracket	12	8mm x 25mm Combo Bolts
1	Passenger/Right Front Mounting Bracket	12	8mm Lock Washers
1	Driver/Left Center Mounting Bracket	12	8mm x 24mm OD x 2mm Flat Washers
1	Passenger/Right Center Mounting Bracket	4	8mm Hex Nuts
1	Driver/Left Rear Mounting Bracket		

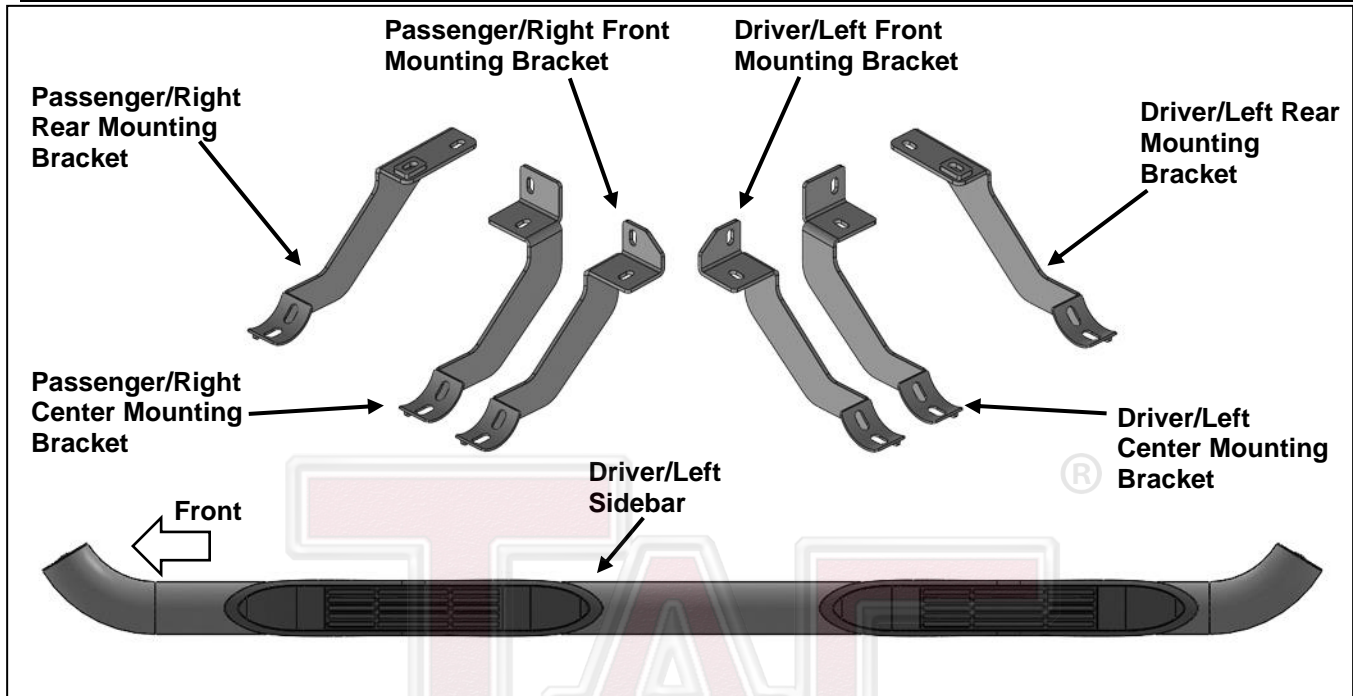

**PROCEDURE:**

- 1. REMOVE CONTENTS FROM BOX. VERIFY ALL PARTS ARE PRESENT. READ INSTRUCTIONS CAREFULLY. USE ILLUSTRATION TO IDENTIFY BRACKETS.**
- Starting on the Driver/Left front of the vehicle, use pry tools to remove plugs and the cover on the bottom of the vehicle, **(Figure 1)**. Select the Driver/Left Front Mounting Bracket. Attach the Mounting Bracket to the threaded stud on the front location with (1) 8mm Flat Washer, (1) 8mm Lock Washer and (1) 8mm Hex Nut, **(Figures 2—4)**. Do not tighten hardware.
- Attach the Mounting Bracket to the threaded insert with (1) 8mm Hex Bolt, 8mm Lock Washer and (1) 8mm Flat Washer, **(Figure 2—4)**. Do not tighten hardware.
- Move along the body panel to the center mounting location, **(Figure 5)**. Select the Driver/Left Center Mounting Bracket. Repeat **Steps 2 & 3** to attach the Bracket, **(Figure 6)**. Do not tighten hardware.
- Continue to the rear mounting location in front of the rear tire, **(Figure 7)**. Select the Driver/Left Rear Mounting Bracket. Attach the Bracket to the (2) threaded inserts with (2) 8mm Hex Bolts, (2) 8mm Lock Washers and (2) 8mm Flat Washers, **(Figures 7—9)**. Do not tighten hardware.
- Unwrap the Driver/Left 3in Sidebar. With assistance, place the Sidebar onto the cradles of the (3) Mounting Brackets. **IMPORTANT:** Do not slide forward, backward or rotate or damage to the finish may result. Attach the Sidebar to the Mounting Brackets with (6) 8mm Combo Bolts, **(Figure 10)**. Do not tighten hardware.
- Level and adjust the Running Board and tighten all hardware.
- Select the factory cover. Line up the cover to the factory mounting holes. Mark where the Center Mounting Bracket sits. Using a hacksaw or sharp knife, cut the cover to allow the Bracket to go through. **(Figure 9)**. Only cut a little at a time.
- Repeat **Steps 2—8** to attach the Passenger/Right 3in Sidebar.
- Do periodic inspections to the installation to make sure that all hardware is secure and tight.

**To protect your investment,** Do not use any type of polish or wax that may contain abrasives that could damage the finish. Mild soap may be used to clean the Running Boards.

### Driver Side Installation Pictured

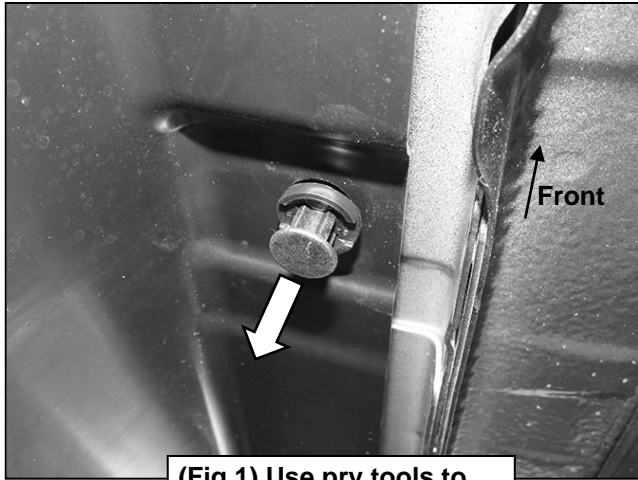

(Fig 1) Use pry tools to remove the plastic cover

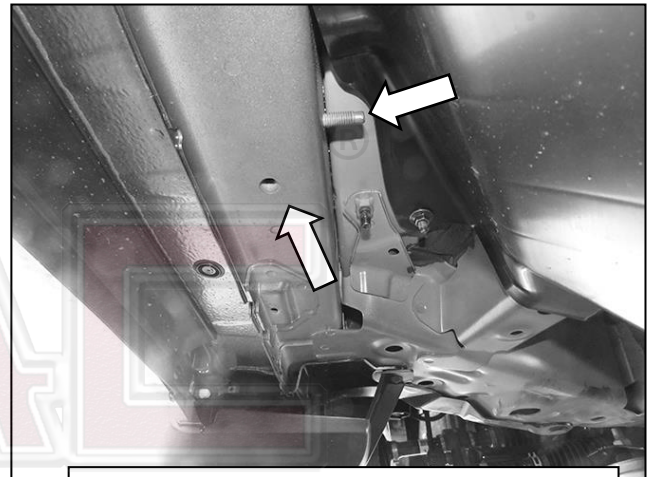

(Fig 2) Driver/Left front mounting location

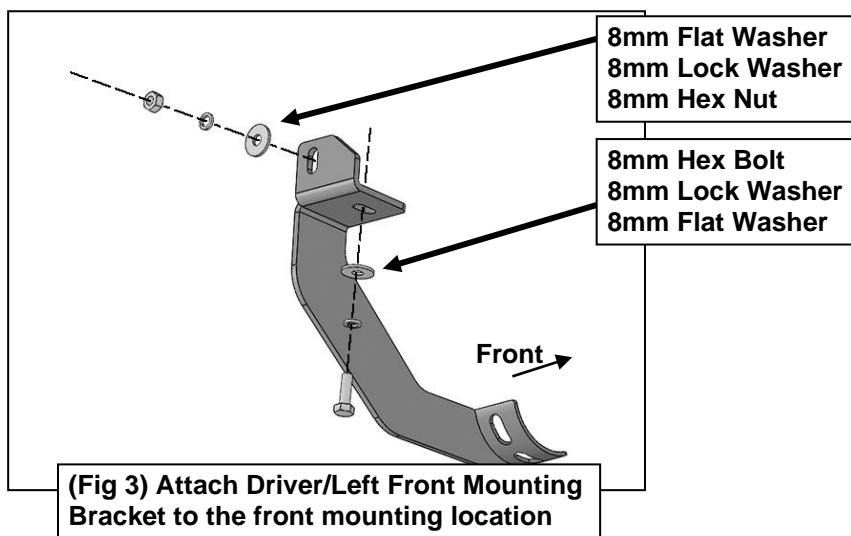

(Fig 3) Attach Driver/Left Front Mounting Bracket to the front mounting location

### Driver Side Installation Pictured



(Fig 4) Driver/Left Front Mounting Bracket attached to the front mounting location

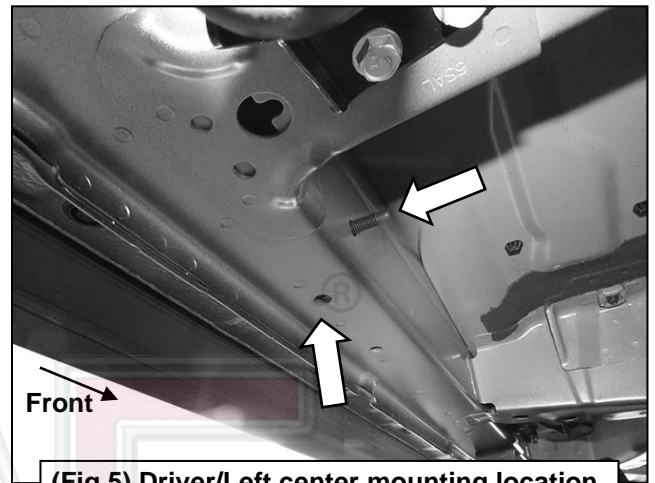

(Fig 5) Driver/Left center mounting location

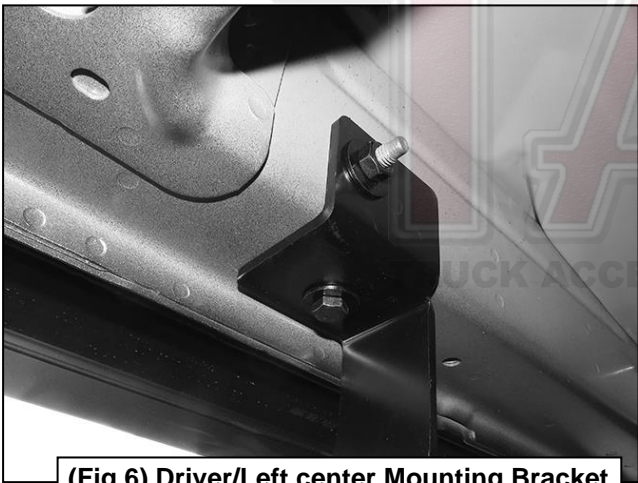

(Fig 6) Driver/Left center Mounting Bracket attached to the center mounting location

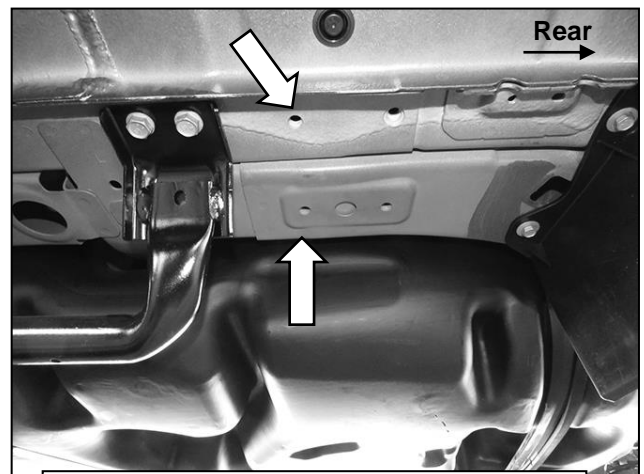

(Fig 7) Driver/Left rear mounting location

### Driver Side Installation Pictured

