



## **INSTALLATION INSTRUCTIONS**

**3" SIDEBAR**

**09-18 DODGE RAM 1500 REGULAR CAB (INCL. 19-23 RAM 1500 CLASSIC)**

**10-24 DODGE RAM 25-5500 REGULAR CAB**

**PART# 223500**

**TAC**<sup>®</sup>  
TRUCK ACCESSORIES COMPANY

## PARTS LIST:

Qty	Description	Qty	Description
1	Driver/Left Sidebar	4	1/2" X 1-1/2" OD x 1/8" flat washers
1	Passenger/Right Sidebar	4	12mm x 35mm Bolt/10mm Nut Plates
1	Driver/Left Front Mounting Bracket	2	12mm x 32mm OD x 3mm Flat Washers
1	Passenger/Right Front Mounting Bracket	2	12mm Lock Washers
1	Driver/Left Front Support Bracket	2	12mm Hex Nuts
1	Passenger/Right Front Support Bracket	4	12mm Plastic Retainers
1	Driver/Left Rear Mounting Bracket	4	10-1.50mm x 35mm Hex Bolts
1	Passenger/Right Rear Mounting Bracket	6	10mm x 30mm OD x 2.5mm flat washers
4	1/2" x 2" Hex Bolts	6	10mm Lock Washers
4	1/2" Lock Washers	2	10mm hex nut
4	8mm-1.25 x 30mm Hex Bolts	2	10mm bolt plate
4	8mm x 28mm OD x 3mm flat washers	1	10mm Fish Wire
4	8mm Lock Washers	2	10mm Plastic Retainer

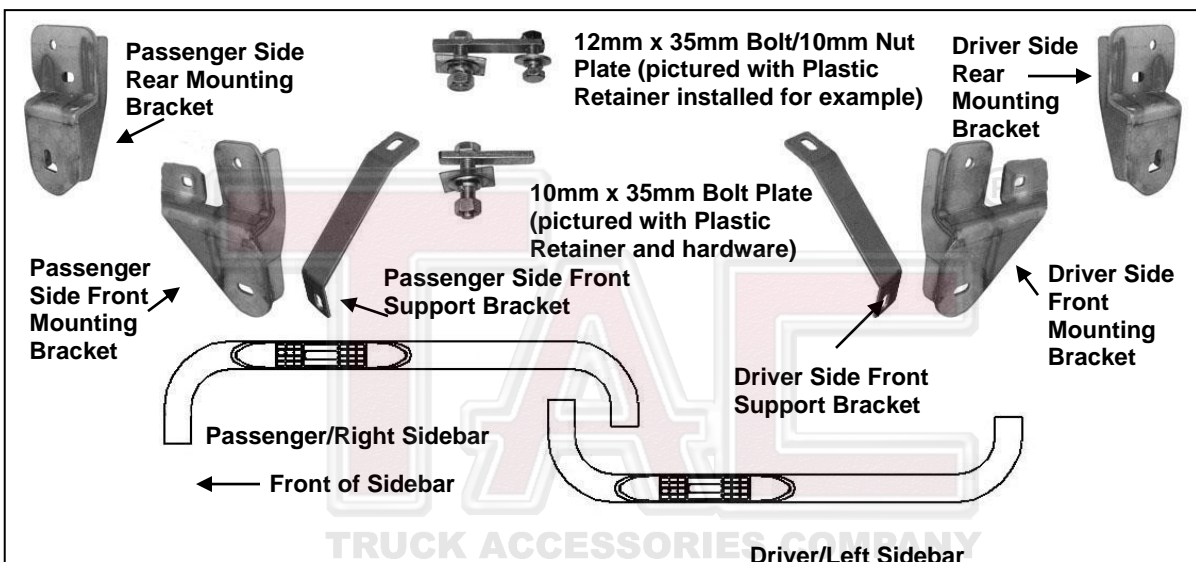

## PROCEDURE:

- REMOVE CONTENTS FROM BOX. VERIFY ALL PARTS ARE PRESENT. READ INSTRUCTIONS CAREFULLY BEFORE STARTING INSTALLATION.**
- Starting at the passenger side-front of the vehicle, remove the tape covering the factory oval holes in the inner body panel located by the front tire.
- Select (1) 10mm Bolt Plate and partially thread a Plastic Retainer onto it, **(Fig 1A)**. Insert the Bolt Plate into the oval hole, **(Fig 1B)**. Once the Bolt Plate is inserted, hold the Bolt end with one hand and tighten the Plastic Retainer with your other hand until it is tight against the body panel. **IMPORTANT:** The Plastic Retainer is designed to prevent the Bolt Plate from falling into the body cavity and to aid in installing the Mounting Bracket.  
**FOR MID-YEAR 2015 & UP MODELS IT WILL BE NECESSARY TO USE THE 10MM FISH WIRE TO INSTALL THIS BOLT PLATE.** Insert fish wire into small slot and fish it until threaded end is present at large slot **(Figure 2A)**. Pull this end out slightly and thread 10mm bolt plate onto end of fish wire **(Figure 2B)**. Carefully feed bolt plate into rocker panel by pulling on opposite end of fish wire. Align 10mm bolt in slot and remove fish wire. Thread the 10mm plastic retainer down the bolt plate until it is flush against the sheet metal. **(Figure 2C)**

4. Next, partially thread a Plastic Retainer onto the threaded end of a 12mm Bolt /10mm Nut Plate, (**Fig 1C**). Insert the Bolt and Nut Plate with Plastic Retainer into the factory oval hole, (**Figure 1B**). **FOR MID-YEAR 2015 & UP MODELS WITH PRE-INSTALLED 8mm THREADED INSERTS, SKIP THIS STEP AND PROCEED TO STEP 5.**
5. Select the passenger side front Mounting Bracket. Position the Mounting Bracket onto the 10mm Bolt Plate. Secure the Bracket to the Bolt Plate with (1) 10mm flat washer, (1) 10mm lock washer & (1) 10mm Hex Nut (**Figure 3**). Do not tighten at this time. Rotate the 12mm Bolt/10mm Nut plate until the threaded Nut end lines up with the remaining hole in the Mounting Bracket and body. Thread (1) 10mm x 35mm Hex Bolt, (1) 10mm Flat Washer and (1) 10mm Lock Washer into the threaded nut plate. **For mid-year 2015 & up Rams equipped with pre-installed 8mm threaded inserts, substitute (1) 8mm x 30mm Hex Bolt, (1) 8mm Flat Washer and (1) 8mm Lock Washer for the 10mm hardware.** Snug but do not tighten hardware at this time.
6. Remove the passenger side front factory body bolt. Select the passenger side Front Support Bracket. Insert the factory body bolt through the Support Bracket and up into its original position, (**Figure 3**). Line the other end of the Support Bracket up with the oval hole in the Front Mounting Bracket. Snug but do not tighten hardware at this time.
7. Move to the passenger side rear of the vehicle and remove the tape covering the factory oval hole in the inner body panel as described in **Step 2**. Thread a Plastic Retainer onto the threaded end of a Bolt and Nut Plate, (**Figures 1C & 4**). Insert the Bolt and Nut Plate into the factory hole, (see **Steps 3 & 4**).
8. Select the passenger side rear Mounting Bracket. Position the Mounting Bracket onto the installed Bolt and Nut Plate. Secure it with (1) 12mm Flat Washer, (1) 12mm Lock Washer and (1) 12mm Hex Nut, (**Figure 5**). Do not tighten at this time. Rotate the Bolt and Nut plate until the threaded Nut end lines up with the remaining hole in the Mounting Bracket and body. Thread (1) 10mm x 35mm Hex Bolt, (1) 10mm Flat Washer and (1) 10mm Lock Washer into the threaded nut on the Bolt and Nut Plate. **For mid-year 2015 Rams equipped with pre-installed 8mm threaded inserts at rear location, there is no need to align threaded nut with bracket and body. Instead, substitute (1) 8mm x 30mm Hex Bolt, (1) 8mm Flat Washer and (1) 8mm Lock Washer for the 10mm hardware.** Snug, but do not tighten hardware at this time.
9. Select the passenger Sidebar and fasten it to the front Mounting Bracket and Support Bracket with the included (1) 1/2" x 2" Hex Bolt, (1) 1/2" Lock Washer and (1) 1/2" Flat Washer, (**Figure 6**). Do not tighten hardware at this time. Attach the Sidebar to the Rear Mounting Bracket with (1) 1/2" x 2" Hex Bolt, (1) 1/2" Lock Washer and (1) 1/2" Flat Washer, (**Figure 5**).
10. Level and align Sidebar properly and tighten all hardware including the factory body bolt.
11. Repeat Steps 2-10 for driver Sidebar installation.
12. Do periodic inspections to the installation to make sure all hardware is secure and tight.

**To protect your investment**, wax this product after installing. Regular waxing is recommended to add a protective layer over the finish. Do not use any type of polish or wax that may contain abrasives that could damage the finish.

**For stainless steel:** Aluminum polish may be used to polish small scratches and scuffs on the finish. Mild soap may be used also to clean the Sidebar.

**For gloss black finishes:** Mild soap may be used to clean the Sidebar.



Fig 1A

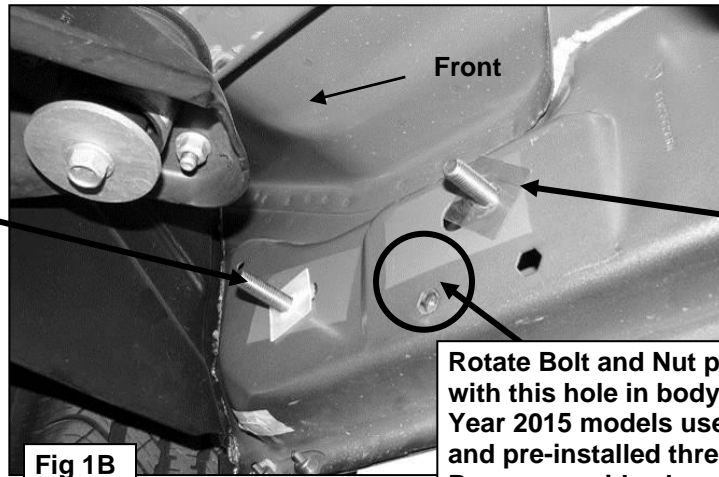

Fig 1B

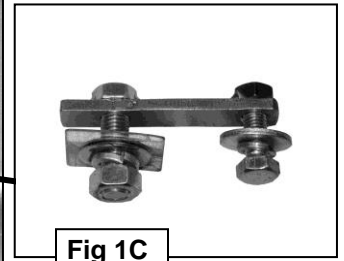
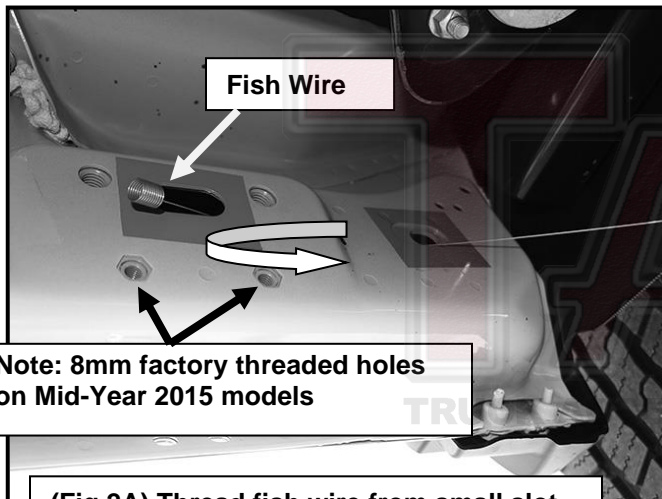

Fig 1C

Rotate Bolt and Nut plate to line up Nut with this hole in body panel. On Mid-Year 2015 models use 8mm hardware and pre-installed threaded inserts. Passenger side shown



Fish Wire

Note: 8mm factory threaded holes on Mid-Year 2015 models

(Fig 2A) Thread fish wire from small slot into large slot. driver side shown

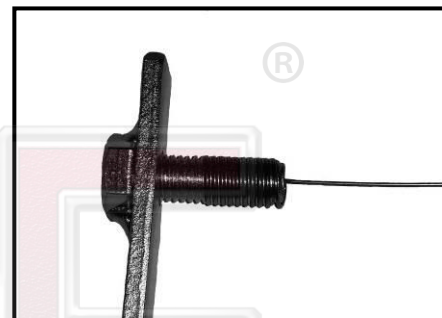

(Fig 2B) Thread 10mm bolt plate onto fish wire. Be careful not to pull other end of fish wire from rocker panel slot

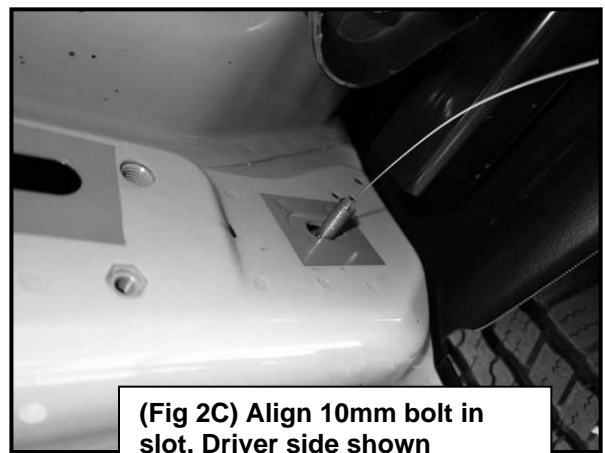

(Fig 2C) Align 10mm bolt in slot. Driver side shown

**PASSENGER SIDE INSTALLATION PICTURED**

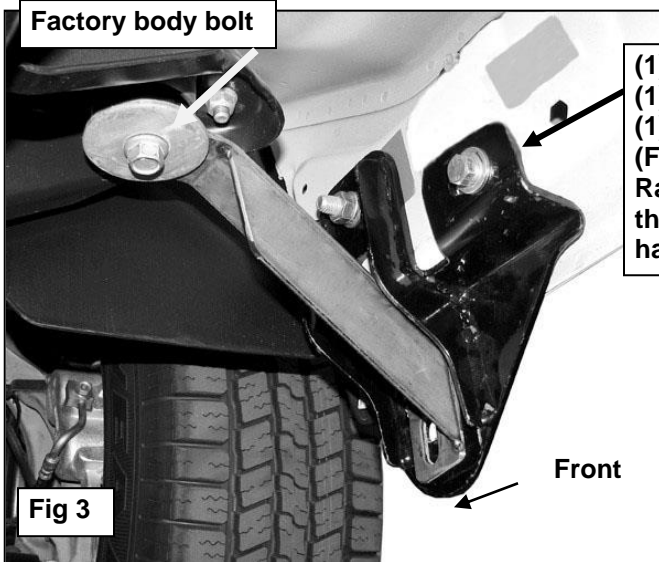

- (1) 10mm x 35mm Hex Bolt
- (1) 10mm Lock Washer
- (1) 10mm Flat Washer
- (For Mid-Year 2015 & up Rams with pre-installed threaded inserts use 8mm hardware)

