

# Vixen®

## Instruction Manual for **VMC260L** Optical Tube Unit

---

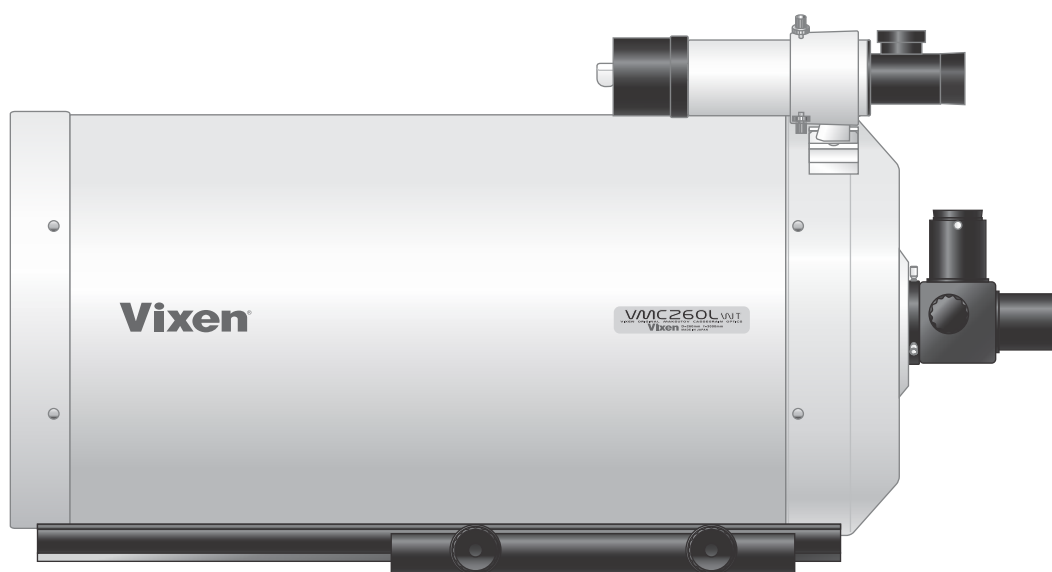

## PREFACE

**Thank you very much for your purchase of a Vixen VC260L optical tube unit.**

This manual applies to VMC260L for AXD Mount by way of example. You may occasionally find descriptions in the text not relevant to your model. Be sure to read instructions for the AXD Mount with this manual if you purchase the VMC260L telescope as a complete package.

**Please read throughout the instruction manual before use and follow the instructions properly.**

This instruction manual will assist you in the safe use of the product. Please be sure to read the safety precautions described below before using the product. Keep this manual nearby to find quick answers to questions.

### **⚠ WARNING !**

**Never look directly at the sun with the telescope or its finder scope or eyepiece. Permanent and irreversible eye damage may result.**

### **ⓘ CAUTION**

- ⓘ Do not leave the optical tube uncapped in the daytime. Sunlight passing through the telescope or finder scope may cause a fire.
- ⓘ Do not use the product while moving or walking, injuries could result from a collision with objects or from stumbling or falling.
- ⓘ Keep small caps, plastic bags, or plastic packing materials away from children. These may cause a danger of swallowing or suffocation.
- ⓘ Do not use the product in a wet environment. This could damage the product, and it may result in electrical shock or a fire.
- ⓘ Do not attempt to disassemble or alter any part of the product that is not expressly described in this manual.
- ⓘ Be sure to handle the product carefully when setting up. Not to drop a screw, a tool, or an object inside the optical tube. This could damage the product or lead to injury

### **HANDLING AND STORAGE**

- Do not leave the product inside a car in bright sunshine, or in other hot places. Keep away strong heat source away from the product.
- When cleaning, do not use solvents such as paint thinner or similar products.
- Do not expose the product to rain, water, dirt or sand.
- Avoid touching any lens surfaces directly with your hands. In case a lens becomes dirty with fingerprints or general smears, gently wipe it using a commercially available lens cleaner and lens cleaning paper or cloth or consult your local Vixen dealer.
- Blow off dust on lenses using a commercially available blower brush.
- For storage, keep the product in a dry place and do not expose to direct sunlight.

### **About Transportation**

**Be sure to turn the focus knob clockwise to the end of its rotation to protect the primary mirror against vibration during transportation. (Do not tighten too strong.) This is important to prevent the optical axis from being out of collimation.**

## Specifications

	Model	VMC260L
<b>Objective Mirror</b>	Optical design	<b>Precision spherical mirror and Meniscus lens system</b>
	Effective aperture	<b>260mm</b>
	Focal length	<b>3000mm</b>
	Focal ratio	<b>1:11.5</b>
	Light gathering power	<b>1380x unaided eye</b>
	Resolving power	<b>0.45 arc seconds</b>
	Limiting magnitude	<b>13.8</b>
<b>Visual Back</b>	Adapter threads	<b>60mm, 42mm for T-ring</b>
	Push-fit	<b>50.8mm, 31.7mm (using a Flip mirror diagonal)</b>
<b>Dimensions and Weight</b>	Optical tube length	<b>680mm (720mm incl. focus knob)</b>
	Optical tube diameter	<b>304mm</b>
	Weight	<b>10 kg (12 kg incl. accessories)</b>
<b>Accessories</b>	7x50mm Finderscope with illuminated reticle (7 degrees field of view) / Wide dovetail slide bar (built-in)	
	Metal carry handle (built-in) / Flip mirror diagonal / Saddle plate	

## Contents

The VMC260L for AXD shipping box contains the items listed below. Check if all the items are included.

1	VMC260L Optical Tube Assembly
1	Saddle Plate (This may not be included in your specific model.)
1	7X50 Finderscope with Illuminated reticle
1	Flip Mirror Diagonal

1	Allen wrenches, 6mm and 2mm on a side
2	M8 bolts
1	Instruction Manual (This booklet)

Note: The contents of your VMC260L optical tube unit may differ when you purchase this item as a mount package complete with an optical tube

## Name of Each Part on the VMC260L



## Attaching the VMC260L to a Mount

⚠ Be sure to handle the saddle plate and VMC260L optical tube carefully as those are rather heavy items.

### Attaching the Saddle Plate to a mount head

The AXD Mount is shown by way of example.



**1** Place the saddle plate on the mount head so that the screw holes match each other.

**2** Attach the saddle plate securely with the two M8 bolts supplied with the VMC260L.

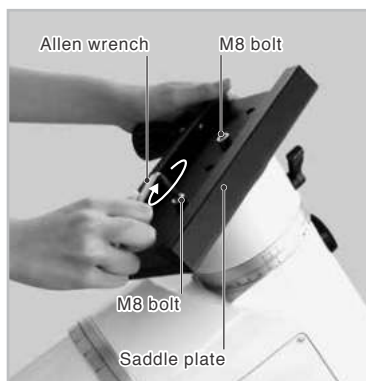

### Attaching the VMC260L optical tube unit to the Saddle Plate

**1** Loosen the lock knobs on the saddle plate before you attach the optical tube.

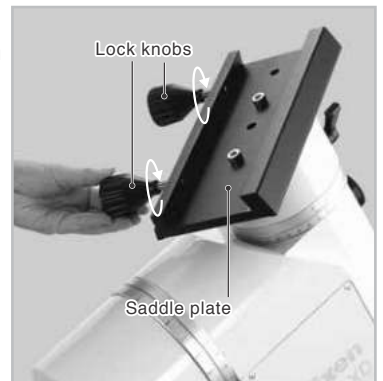

**2** Slide the dovetail slide bar on the bottom of the optical tube onto the sunken platform of the saddle plate.

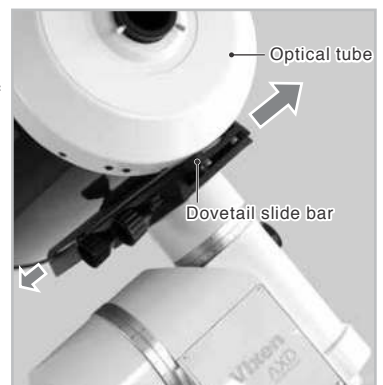

**3** With holding the optical tube, tighten the two lock knobs on the saddle plate securely.



## Setting up the 7x50mm Finderscope (Attaching to the Finder Bracket)

You need to align the finderscope before use. Read page 6 to adjust the finderscope after you finish assembling the finderscope.

- 1 Loosen three grub screws in advance on the finder bracket with the supplied Allen wrench until the tips of these screws no longer extend into the inner part of the bracket ring. Also loosen three adjustment screws on the front side of the bracket ring equally by hand to allow passage of the finderscope.

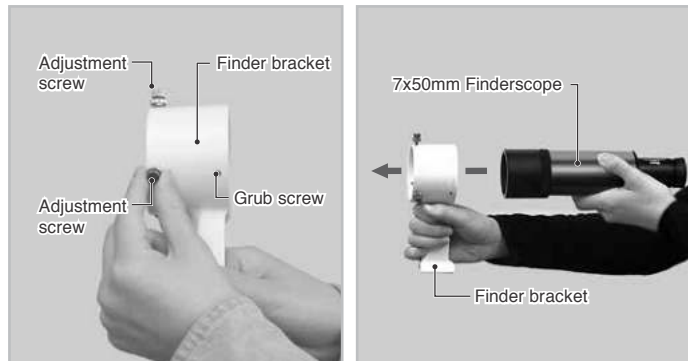

- 2 Slide the finderscope into the bracket ring from its objective end as shown in the figures. Tighten the three grub screws gently and equally with the Allen wrench at this stage so that the finderscope becomes stable and does not rattle inside the bracket ring. Then, tighten the three adjustment screws equally to fix the finderscope.

It is unavoidable that the grub screws mar the surface of the finderscope tube by tightening.

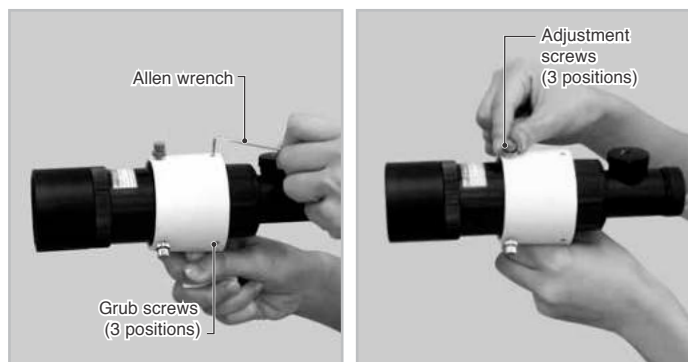

- 3 Loosen the chrome lock screw on the finder bracket shoe of the telescope optical tube. Slide the finderscope onto the finder bracket shoe and tighten the chrome lock screw securely.

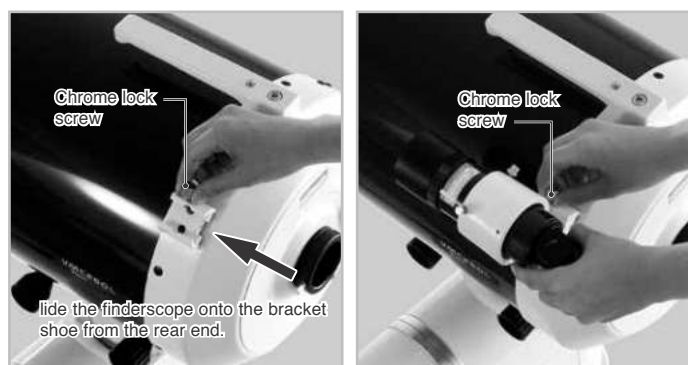

## Attaching the Flip Mirror Diagonal

- 1 Loosen the two setscrews on the visual back and insert the flip mirror diagonal as shown in the figure.

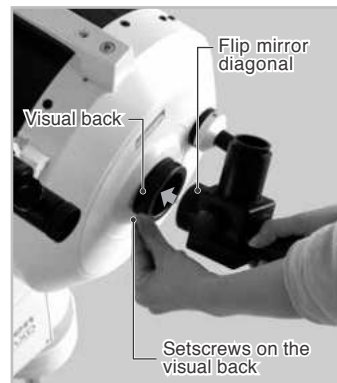

- 2 Tighten the two setscrews to hold the flip mirror diagonal steadily after inserting it into the visual back.

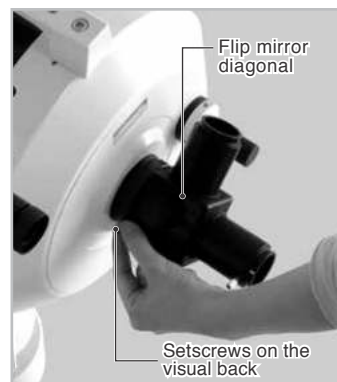

## Attaching an Eyepiece

- 1 Loosen the setscrew on the flip mirror diagonal and insert a 31.7mm eyepiece (1.25" barrel) into its eyepiece adapter as shown in the figure.

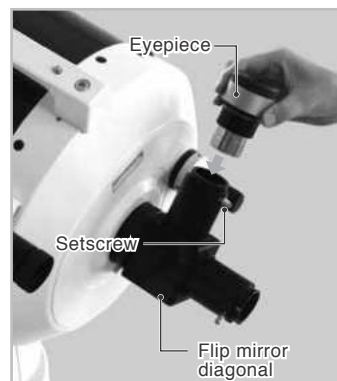

- 2 Tighten the setscrew to hold the eyepiece steadily after inserting it into the eyepiece adapter.

Set the eyepiece to use either in the 90-degree angled or straight through viewing position.

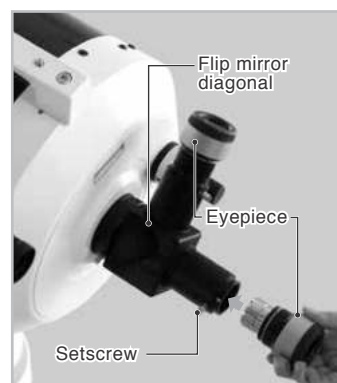

## Balancing the VMC260L using a Counterweight(s)

Be sure to balance the telescope on the AXD mount (or your equatorial mount) correctly to ensure smooth and accurate movements of the RA and DEC axes. An unbalanced mounting may cause vibration and can result in tracking errors or failure of the rotation mechanism.

## Visual Observing Configuration

The VMC260L requires an eyepiece to view images. The eyepiece determines magnification of your telescope.

The telescope may come with the eyepiece as standard accessory when you purchase it as a package including a mount.

### Magnification of the telescope

Begin with an eyepiece with long focal length (large number in millimeters). When using an eyepiece with short focal length, the image becomes dimmer and the range of field of view becomes narrower. Also, the range of sharp focus becomes smaller.

Dividing the focal length of the telescope by the focal length of the eyepiece gives the magnification.

Example: Using the VMC260L with an SLV20mm or an SLV5mm eyepiece.

Eyepiece	Telescope's focal length	Eyepiece's focal length	Magnification
SLV20mm	3000mm	20mm	150X
SLV5mm	3000mm	9mm	333X

### Focusing the telescope

Look through the VMC260L with an eyepiece of low magnification. Turn the focus knob clockwise or counter-clockwise until images in the eyepiece's field of view come to focus clearly.

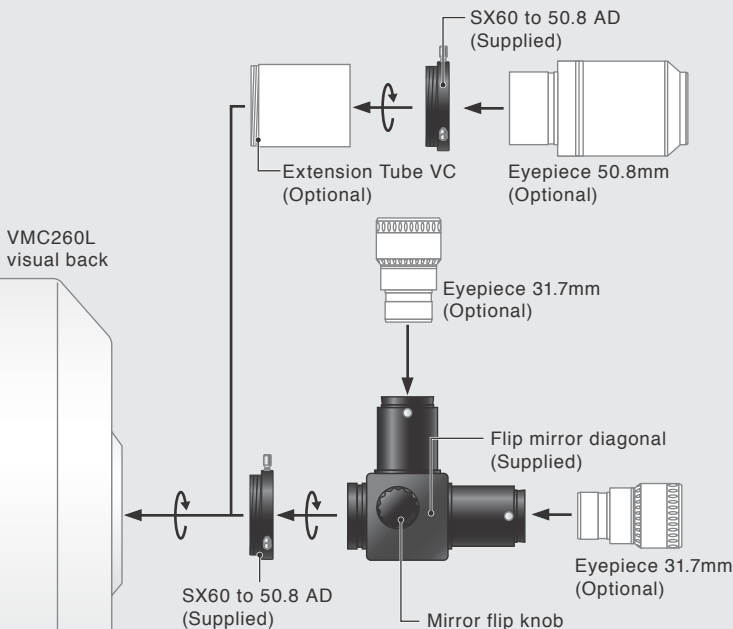
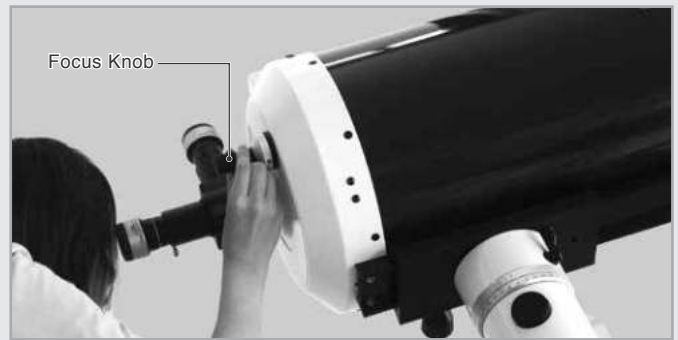

## Photographic Configuration

Some of the optional accessories shown in this diagram will be needed if you take pictures with a DSLR camera, a compact camera, or a CCD/CMOS camera.

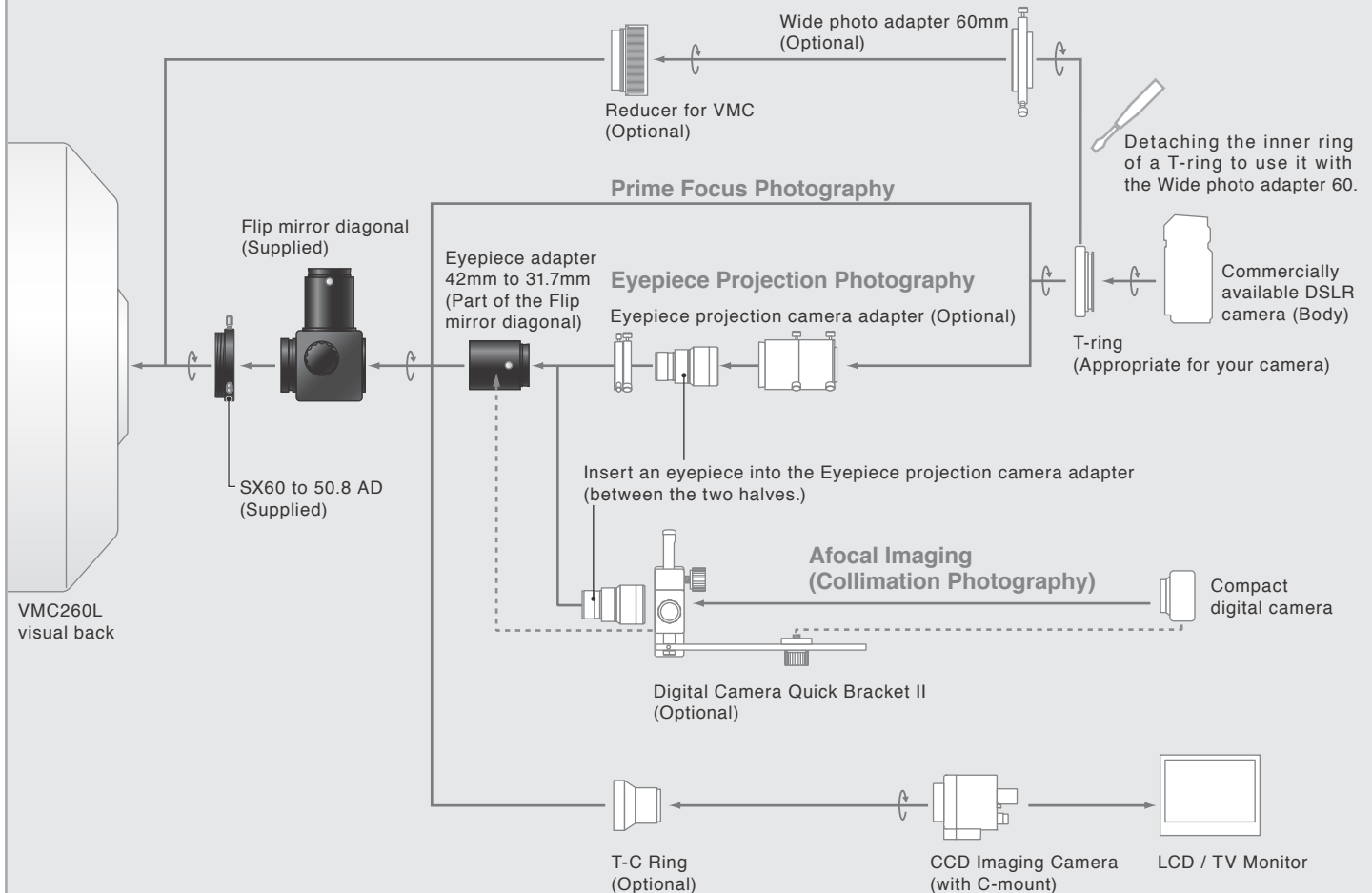

## Dovetail slide bar

### The necessity of a finderscope

It is very difficult for the telescope user to locate a target object through the telescope's field of view at high magnification, especially as the field of view narrows. The use of a finderscope will make it much easier.

### Be sure to align the finderscope with the telescope's field of view before you start observing.

The field of view of finderscope does not align to the telescope when you merely attach it to the finder bracket shoe on the telescope.

#### About 7X50 finderscope with illuminated reticle

The finderscope has crosshairs to aim the telescope at a target. This facilitates bringing the target to the center of the telescope's field of view as you can overlay the target at the center of the crosshairs. A distant tower is used as a target in this manual by way of example.

#### ⚠ Caution!

Do not loosen adjustment screws too much. It may cause falling off the finderscope and may lead to injury or damage.

**1** Choose a conspicuous target in the distance (over 200m away) and place the target in the center of a field of view of the telescope.

The image in the telescope's field of view is usually upside down or mirror-reversed erect image.

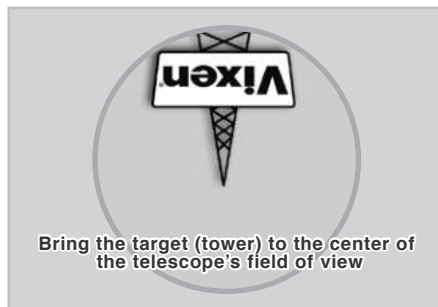

**2** Next, look through the finderscope. You should probably find the same target somewhere within the finder's field of view. In the illustration, the tower is seen in the upper left of the finder's field of view.

If the crosshairs are out of focus, turn the end of the finderscope's eyepiece to reach focus.

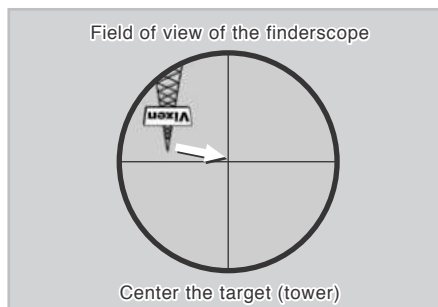

If the finderscope is out of focus on the target, please refer to focusing the finderscope on page 7.

The image in the finderscope's field of view is upside down. The crosshairs go to a tilted position according to the state of the finderscope attached.

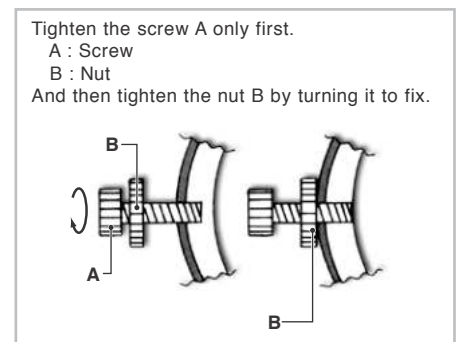

**3** While looking through the finderscope, align the field of view with the telescope's field of view by loosening or tightening the adjustment screws on the finder bracket so that the target comes close to the center of the field of view.

Adjust the finderscope by loosening two adjustment screws out of three adjustment screws and tightening the remaining one adjustment screw so that the target can be shifted gradually onto the center of the cross hairs. Be sure not to over loosen the adjustment screws to avoid falling off.

Finally, you can see the target in the same position in the field of view of both the telescope and finderscope. You should use an eyepiece of high magnification over 100x if you want to increase the accuracy in centering a target in the telescope's field of view.

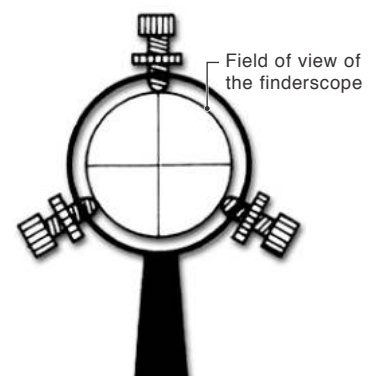

Image: Finderscope bracket and finderscope

## Adjusting the Illuminated Reticle on the Finderscope

The built-in illumination of the finderscope allows you to easily recognize the dim crosshairs in the dark field of view of the finderscope.

- The brightness of the illuminated reticle varies gradually as you turn the brightness adjustment dial.
- Don't forget to turn off the illuminated reticle after you finish using the finderscope.
- The dial will return to the "off" position if you continue turning.
- Adjust the brightness properly. The brighter the illumination of the reticle, the sooner the consumption of the battery. If too bright, it makes stars in the field of view invisible.



## Focusing the Finderscope

The finderscope is adjusted to focus on infinity at Vixen's factory before shipment. Because the ability of vision differs with individual persons, it is possible that you will need to readjust the focus of your 7X50mm finderscope.

### Focus on the crosshairs

While looking through the finderscope, turn the end of the finderscope's eyepiece to left or right by hand to bring the cross hairs reticle into focus.

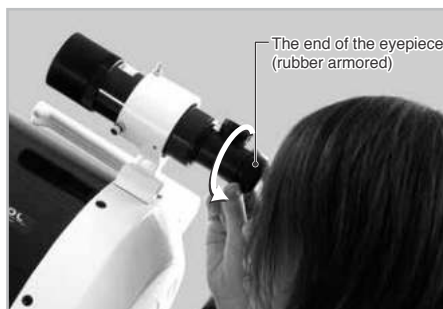

### Focus on the target

While holding the lock ring next to the objective lens cell of the finderscope, turn the objective lens cell so that it loosens. Find a position of the objective lens cell that brings a distant view into focus. Tighten the objective lens cell with the lock ring at that position.

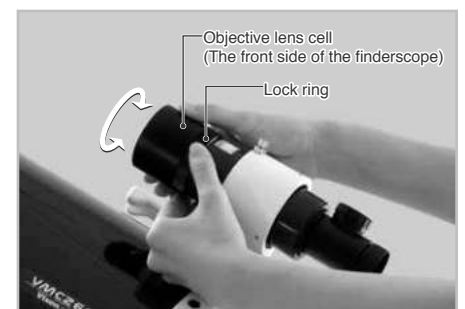

## How to Collimate the VMC260

Your VMC260L is collimated at Vixen's factory. The optical tube holds the collimation unless it is handled roughly. You can re-collimate the VMC260L by way of the following procedures if necessary.

- 1 Locate three Allen screws that are set near the center of the four-vane spider on the front of the optical tube.

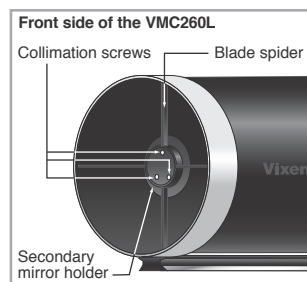

- 2 Attach an eyepiece with medium power (80x or adjacent) onto the eyepiece holder and bring a bright star such as Polaris into the field of view. Turn the focus knob to defocus the star image fully until it is enlarged and blurred as much as one third of the viewing field. The silhouette of secondary mirror is seen near the center of the blurred star image at this time.

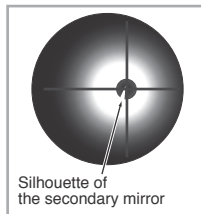
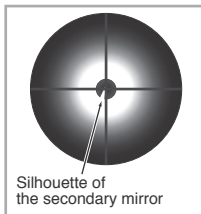

- 3 If optical axis is aligned correctly, both the blurred star image and silhouette of the secondary mirror can be seen at the center of the field of view. If it is not aligned concentrically, move those images to the center of the field of view. With an Allen wrench, adjust the collimation screw nearest or furthest from the direction of those images.

- 4 Turn the collimation screw clockwise or counterclockwise gradually until the blurred star image and silhouette of the secondary mirror are aligned concentrically in the center of the field of view.

- 5 Use an eyepiece with high magnification and repeat the above procedures so that you can make more precise re-collimation of the optical axis.

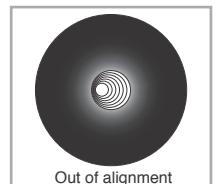

Out of alignment

- 6 After you collimate the VMC260L properly, you perform a star test with a medium to high power eyepiece by selecting a star of the second or third magnitude.

Note: Right after you focus on the star precisely, defocus the star image slightly to look at a diffraction pattern of the star.

It is essential to collimate the telescope under good seeing condition.



Misaligned slightly

- 7 If the concentric diffraction rings can be seen, the optical axis has been re-collimated precisely.

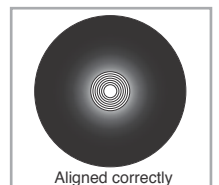

Aligned correctly

### Tips on the collimation

1. It will be efficient if one person checks the star image and another person adjust the collimation screws.
2. The star image moves largely even if you turn the collimation screw a little.
3. If one of the collimation screws are hard to turn, be sure to turn the opposite two screws in a reverse direction.

# Vixen®