

# Vixen®

## Instruction Manual for AP Equatorial Mount / AP-SM Equatorial Mount / AP Photo Guider







## PREFACE

Thank you for your purchase of a Vixen product from the Vixen AP series of equatorial mounts and equatorial platform. This instruction manual is prepared in common with the AP series of the equatorial mounts including the AP-SM equatorial mount and AP Photo Guider. You may occasionally find descriptions in the text not relevant to your model. The manual explains usage of the AP-SM mount with STAR BOOK ONE mostly by way of example. Please be sure to read the instructions throughout to make you use the product right and in safety.











This equipment has been tested and found to comply with the limits for a Class B digital device, pursuant of Part 15 of the FCC rules.

## SAFETY PRECAUTIONS





This instruction manual will assist you in the safe and effective use of the AP Mount. Before using the mount, be sure to read the safety precautions described below carefully.

Legend	
 <b>Warning</b>	<b>If misused, it can cause you a serious injury or death.</b>
 <b>Caution</b>	<b>Misuse can cause injury or damage to you or other property.</b>
 <b>Important</b>	<b>You must complete all of the steps in this manual.</b>
 <b>Direction</b>	<b>You must completely execute the instructions in this manual.</b>





### **WARNING!**

-  **Never look directly at the sun with your naked eyes or through your telescope and finder scope. Permanent and irreversible eye damage may result.**
-  **Do not leave the optical tube uncapped in the daytime. Sunlight passing through the telescope or finder scope may cause a fire.**
-  **Do not use the product in a wet environment. This could damage the mount, result in electrical shock or a fire.**
-  **Do not attempt to disassemble or alter any part of the equipment that is not expressly described in this manual. This could damage the mount, result in electrical shock, a fire or lead to an injury.**
-  **Keep small caps, plastic bags or plastic packing materials away from children. These may cause choking or suffocation.**
-  **Stop operating the product immediately and unplug the power cord if it emits smoke or a strange smell. This could result in fire or electrical shock. Make sure to be safe and consult your local Vixen dealer or distributor in your country.**
-  **Do not allow liquids or foreign objects to enter the product. Unplug the power cord or switch the power off. This could result in fire or electrical shock.**
-  **Do not damage, alter or place heavy item on the power cord. This could result in fire or electrical shock.**
-  **The product includes heavy items such as the counterweight and the mount body. Be sure to handle these units carefully. Be careful not to drop the unit when handling. This may cause damage or lead to injury.**
-  **Be sure to ventilate air while cleaning with volatile cleaner or spray can cleaner to avoid poisoning.**
-  **Do not use the volatile cleaner or spray can cleaner in the vicinity to fire. This could lead to catching fire.**

### **CAUTION**

-  **Do not operate the product with wet hands. Plugging in and out the power cord, electricity connectors and operating the electronic parts with wet hands may cause damage to the equipment or resulting in electrical shock.**
-  **Do not use the product while traveling or walking, as injuries may arise from stumbling, falling or collision with objects.**
-  **Do not bundle the power cord and electricity wires during the operation. This may result in a short circuit and damage to the surroundings.**
-  **Handle the power cord and electricity connectors properly. Do not pull the power cord by force when disconnecting. This may damage the cord and connectors, resulting in fire or electrical shock.**

## HANDLING AND STORAGE

-  **Do not leave the product inside a car in bright sunshine, or in hot places. Keep any strong heat radiation sources away from the product.**
-  **When cleaning, do not use solvent such as paint thinners. It may cause deterioration.**
-  **Do not use the product in a wet environment. This may cause the product to malfunction or result in fire or electrical shock.**
-  **For storage do not expose to direct sunlight and keep the product in a dry place.**
-  **Do not expose the product to rain, water drops, dirt or sand. Gently wipe the product with a damp cloth for cleaning.**

**SAFETY PRECAUTIONS** -----P 2

**TABLE OF CONTENTS** -----P 3

**BEFORE USE**

AP Mount  
 : Check the Package Contents -----P 4  
 : Name of Each Components -----P 5  
 : Mount Specifications-----P 5

AP Photo Guider  
 : Check the Package Contents-----P 6  
 : Name of Each Components -----P 7  
 : Mount & Cotroller Specifications-----P 8

AP-SM Mount  
 : Check the Package Contest -----P 9  
 : Name of Each Components -----P10  
 : Mount & Cotroller Specifications -----P11

STAR BOOK ONE  
 : Components Guide -----P14

**PREPARATION**

Assembling the Mount -----P15  
 : Setting up the Tripod -----P15  
 : Attaching the Counterweight -----P18  
 : Attaching the Optical Tube Assembly -----P19  
 : Attaching the Dovetail Slide Bar (AP Photo Guider)----P20  
 : Balancing the Equatorial Mount -----P21  
 : Connecting the STAR BOOK ONE-----P25  
 : About Power Supply-----P26

**INITIAL SETTING AND BASIC OPERATION**

: Tuning on the Power -----P28  
 : Setting Language -----P28  
 : Moving the AP Mount  
 / Moving the AP-SM Mount or Photo Guider -----P29  
 : Changing the Slewing Speed -----P29  
 : Changing Tension of the Friction Stop Motion ----P30  
 : Approximate Polar Aligning with the Finder Scope ----P31  
 : Approximate Polar Aligning with the Polar Meter-----P33

**APPLICATION**

: Polar Alignment Scope -----P34  
 : Polar Alignment in the Northern Hemisphere-----P36  
 : Polar Alignment in the Southern Hemisphere ----P41  
 : Mount Menu -----P47  
     Tracking Speed -----P47  
     Tracking Direction -----P48  
     Slewing Speed -----P48  
     Backlash Compensation -----P49  
     Setting for Autoguider -----P51  
     PEC -----P52  
 : Display Menu -----P54  
     Contrast Adjustment -----P54  
     Brightness Adjustment -----P54  
     Backlight Adjustment -----P54  
     Red LED Light Adjustment -----P55  
 : Other Functions-----P55  
     Field of View Orientation-----P55  
     Reset-----P55

AP Mount Composition Chart -----P56  
 Variations on the AP Mount -----P57  
 How to Change the Modules -----P58  
     : Changing the R.A. Motor Module for the Manual  
     Slow Motion Control Module.-----P58  
     : Changing the Manual Slow Motion Control Module  
     for the DEC. Motor Module.-----P60  
     : Changing the Maunal Slow Motion Control Module  
     for R.A Motor Module. -----P62  
     : Upgrading the AP Photo Guider to the AP Mount.-----P64

Replacing the Fuse -----P67

**SPECIFICATIONS**

Dimensions-----P68

## BEFORE USE

### Check the Package Contents

### AP Mount

The AP equatorial mount contains the items listed below. Check if all the items are included.

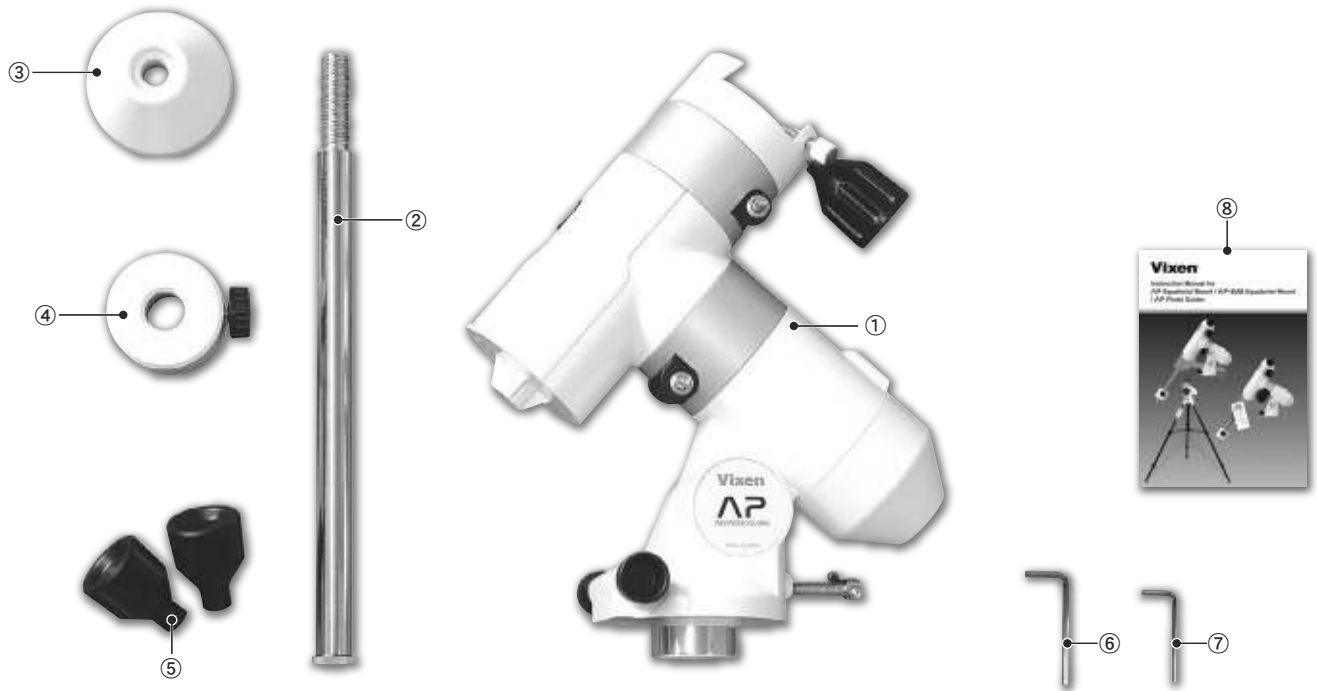

#### Package consisting of:

① AP Equatorial Mount (Main body) -----	1
② Counterweight Bar-----	1
③ Vanity Ring for Counterweight Bar -----	1
④ Counterweight 1.0kg-----	1
⑤ Slow Motion Control Knob-----	2
⑥ Allen Wrench of 4mm on a side -----	1
⑦ Allen Wrench of 3mm on a side -----	1
⑧ AP Mount Instruction Manual (This book) -----	1

#### Note :

The contents of your AP mount package may differ when you purchase it as a complete AP telescope package.

## Basics of the Equatorial Mounts

### What is an Equatorial Mount?

In the northern hemisphere, stars appear to turn around the polar star (the north celestial pole) making approximately one rotation per day. This is called diurnal motion and occurs because the earth turns on its own axis once a day. The equatorial mount is a platform which is designed to rotate parallel to earth's rotational axis.

### Basic Motion of the AP Equatorial Mount

The AP equatorial mount moves and stops with friction in the right ascension (R.A) and declination (DEC). Slew the telescope by hand to change the telescope's direction. The AP-SM mount comes equipped with a drive motor on the R.A axis and a manual slow motion control knob on the DEC axis.

The equatorial mount will achieve smooth movements if each of the rotational axes on the mount is balanced correctly.

An unbalanced equatorial mount may cause vibration and can result in slipping of the friction stop mechanism. Make sure that your telescope is well balanced after your accessories have been installed.

Be careful not to bang any part of the mount against other objects. This could damage the gears and bearings.

## BEFORE USE

### Name of Each Component

### AP Mount

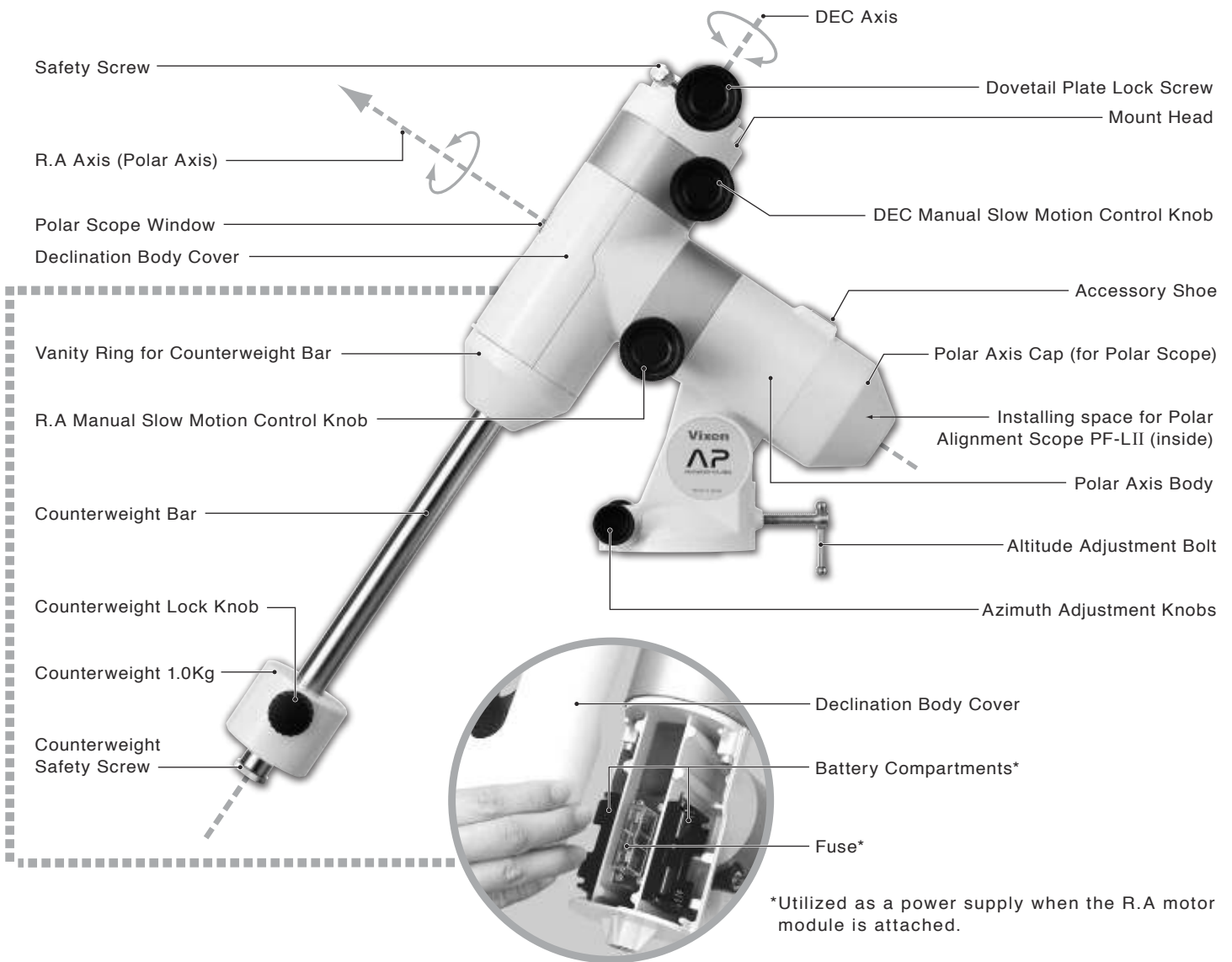

### Mount Specifications

Mount	AP equatorial mount
Slow Motion Control	R.A: Wheel and worm gears full circle micro movement DEC: Wheel and worm gears full circle micro movement
Quick Slewing Motion	Friction stop motion (adjustable)
Wheel Gear	R.A: 73.5mm in diameter, 144-tooth wheel gear / DEC:58.4mm in diameter, 144-tooth wheel gear
Worm Gear	R.A :11.0mm in diameter, Brass / DEC:9.8mm in diameter, Brass
R.A Axis	59mm in diameter, Aluminum alloy, with friction stop mechanism
DEC Axis	59mm in diameter, Aluminum alloy, with friction stop mechanism
Number of Bearings	7 pieces
Counterweight Bar	20mm diameter, Steel
Polar Alignment Scope	Optional
Azimuth Adjustment	Fine adjustment range: +/- 6.5 degrees, 1.4 degrees per rotation, Twin adjustment screws with knobs
Altitude Adjustment	Latitude adjustment range: 0 degree to 65 degrees, Tangent screw with handle, 1.9 degrees per rotation
Maximum Loading Weight	6kg (13.2lbs)(150kg · cm torque load) at a point of 25cm from the fulcrum
Fuse	125V 1A Class B (PSE standard), 6mm dia x 30mm long
Dimensions	263 x 302 x 96mm (10.3" x 11" x 3.7")
Weight	3.6kg (8 lbs) without counterweight
Counterweight	1.0kg (2.2 lbs)
Optional Accessories	R.A motor module and STAR BOOK ONE Set, DEC motor module, APP-TL130 tripod, Polar alignment scope PF-LII, Polar Meter

The specifications are subject to change without notice.

## BEFORE USE

### Check the Package Contents

### AP Photo Guider

The AP Photo Guider package contains the items listed below. Check if all the items are included.



#### Package consisting of:

① AP Photo Guider Equatorial Platform-----	1
② Dovetail Slide Bar PG -----	1
③ STAR BOOK ONE Controller -----	1
④ STAR BOOK Cable (for SBT)-----	1
⑤ Strap for STAR BOOK ONE -----	1
⑥ APP-TL130 Tripod-----	1
⑦ Allen Wrench of 5mm on a side -----	1
⑧ Allen Wrench of 4mm on a side -----	1
⑨ Allen Wrench of 3mm on a side -----	1
⑩ AP Photo Guider Instruction Manual (This book)-----	1

Note 1: Power supply is not included.

Note 2: Use a commercially available USB external power supply.

For AP Photo Guider with Single-axis drive unit (Standard): USB external battery of at least 0.5 ampere is required (applicable to USB Micro-B connector).

For AP Photo Guider with Dual-axis drive unit (Optional): USB external battery of at least 1.0 ampere is required (in conformity to DCP and applicable to USB Micro-B connector).

The DCP (Dedicated Charging Port) is a regulation of USB external power supply which is stipulated in USB Battery Charging Specification, Rev 1.1. It is used for USB batteries and USB AC Adapters.

**BEFORE USE**

Name of Each Component:

**AP Photo Guider**

**Equatorial Platform**

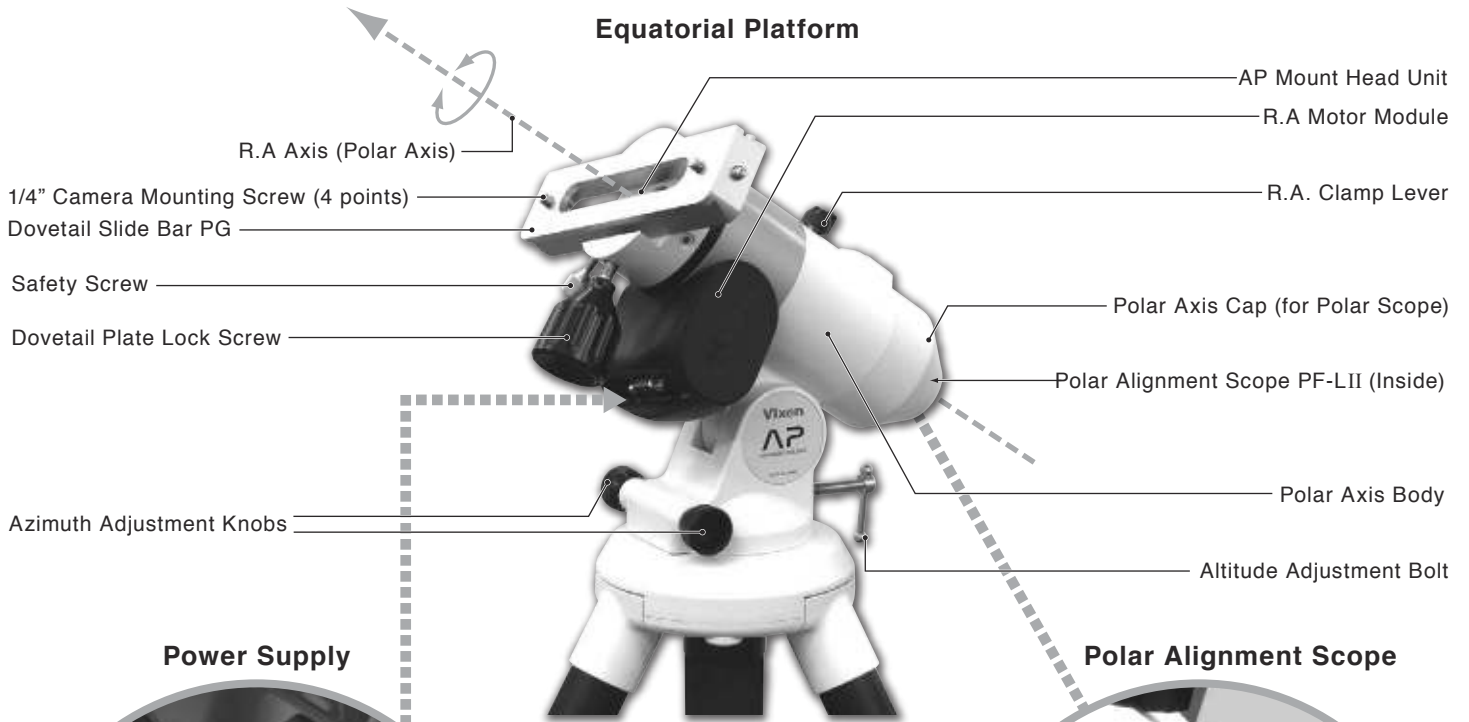

**Power Supply**



**Polar Alignment Scope**



**Tripod**



## BEFORE USE

### Mount Specifications

### AP Photo Guider

Mount	AP Photo Guider mount
Slow Motion Control	R.A: Wheel and worm gears full circle micro movement
Quick Slewing Motion	Friction stop motion (adjustable)
Wheel Gear	R.A: 73.5mm in diameter, 144-tooth wheel gear
Worm Gear	R.A :11.0mm in diameter, Brass
R.A Axis	59mm in diameter, Aluminum alloy, with friction stop mechanism
Number of Bearings	4 pieces
Polar Alignment Scope	5x20mm (Field of view: 10 degrees), Self-light-off dark field illuminator (Brightness adjustable), Setting accuracy: 3 arc minutes or less, Reticle with scales for pointing 3 stars, Battery: CR2032
Azimuth Adjustment	Fine adjustment range: +/- 6.5 degrees, 1.4 degrees per rotation, Twin adjustment screws with knobs
Altitude Adjustment	Latitude adjustment range: 0 degree to 65 degrees, Tangent screw with handle, 1.9 degrees per rotation
Motor Drive	Pulse (Stepping) Motor
Tracking	High precision tracking with STAR BOOK ONE controller
Maximum Loading Weight	6kg (13.2 lbs) (150kg · cm torque load) at a point of 25cm from the fulcrum
Controller Cable Connecting Port	D-SUB 9PIN male plug
Power Supply Port	USB Micro-B (DC4.4 to 5.26V)
Power Supply	USB External battery pack (Not sold by Vixen)
Working Duration with Batteries	About 4 hours (at 20 degree C, with Alkaline batteries, 6kg loading weight ), 2.5 hours if the DEC motor module is used together.
Electricity Consumption	DC5V · 0.2 ~ 0.5A (1.0 ~ 2.5W) , 0.3 ~ 1.0A (1.5 ~ 5.0W) if the DEC motor module is used together.
Dimensions	222 x 221x 96mm (8.7" x 8.7" x 3.7")
Weight	2.4kg (5.3 lbs) (5.4kg (12 lbs) complete with tripod)
Optional Accessories	Supplementary Counterweight Bar, Counterweight 1.0kg, Polar Meter

### Controller Specifications

Controller	STAR BOOK ONE
CPU	32-bit CISC Processor 40MHz RX210
LCD Screen	2-line 8-character STN with backlight
Autoguider Port	6-pole 6-wired modular jack (for external autoguider)
Controller Cable Port	D-SUB 9PIN male plug
Power Supply	Supplied from the mount side
Operating Temperature	Between 0 degree C and 40 degree C (104 F)
Dimensions	137 x 65 x 21mm (5.4" x 2.5" x 1")
Weight	110g (4 oz) (without cable)
Menus and Major Functions	Sidereal tracking rate (variable from 0.1X to 10X by step), Solar tracking, Lunar tracking and Kings rates, Backlash compensation, PEC, External autoguider connection, Adjustable LED backlight, Red LED Light

The specifications are subject to change without notice.



## BEFORE USE

### Check the Package Contents

### AP-SM Mount

The AP-SM equatorial mount package contains the items listed below. Check if all the items are included.



#### Package consisting of:

① AP-SM Equatorial Mount (Main body)	-----	1
② AP Counterweight Bar	-----	1
③ Vanity Ring for Counterweight Bar	-----	1
④ Counterweight 1.0kg	-----	1
⑤ Slow Motion Control Knob	-----	1
⑥ STAR BOOK ONE Controller	-----	1
⑦ STAR BOOK Cable (for SBT)	-----	1
⑧ Strap for STAR BOOK ONE	-----	1
⑨ Allen Wrench of 4mm on a side	-----	1
⑩ Allen Wrench of 3mm on a side	-----	1
⑪ AP-SM Mount Instruction Manual (This book)	-----	1

Note 1: The contents of your AP-SM mount package may differ when you purchase it as a complete AP-SM telescope package.

Note 2: The AP-SM packages do not contain an adapter for power supply. Use 4 x AA batteries (not included) or a commercially available USB external battery with USB Micro-B adapter.

#### Power Supply to AP-SM Mount:

The USB external power supply battery of at least 0.5 ampere is required for operation. USB Micro-B adapter is needed.

#### Power Supply to AP-SM Mount plus DEC Motor Module:

The USB external power supply battery of at least 1.0 ampere is required for operation. USB Micro-B adapter is needed. If the power supply is not sufficient, the DEC motor will stop along with a blinking message "Y motor stop".

The USB external power supply battery in conformity to DCP (Dedicated Charging Port) of USB Battery Charging Specification, Rev 1.1 is required.

# BEFORE USE

## Name of Each Component:

## AP-SM Mount

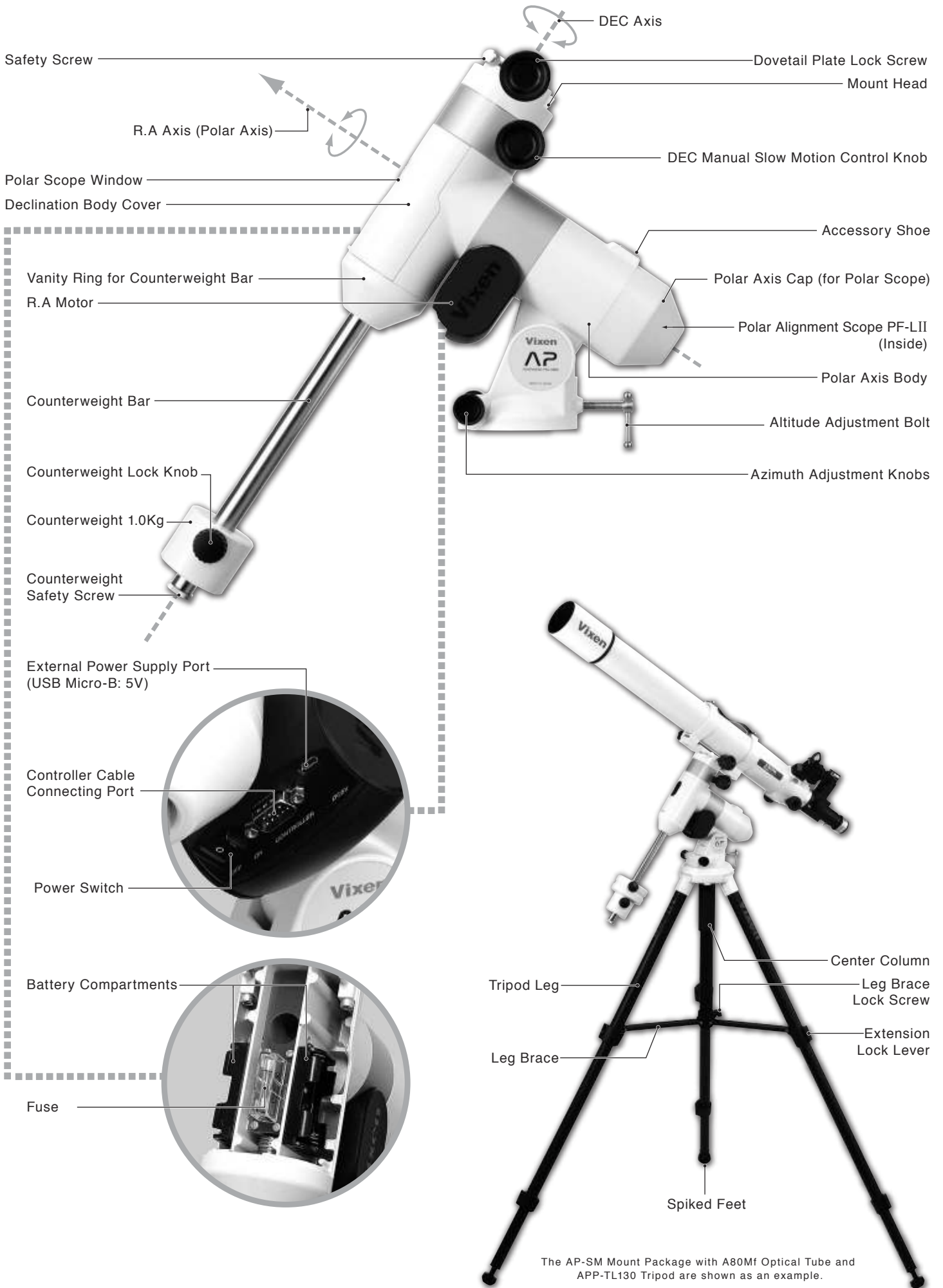

The AP-SM Mount Package with A80Mf Optical Tube and APP-TL130 Tripod are shown as an example.

**BEFORE USE****Mount Specifications****AP-SM Mount**

Mount	AP-SM equatorial mount
Slow Motion Control	R.A: Wheel and worm gears full circle micro movement DEC: Wheel and worm gears full circle micro movement
Quick Slewing Motion	Friction stop motion (adjustable)
Wheel Gear	R.A: 73.5mm in diameter, 144-tooth wheel gear DEC:58.4mm in diameter, 144-tooth wheel gear
Worm Gear	R.A :11.0mm in diameter, Brass DEC:9.8mm in diameter, Brass
R.A Axis	59mm in diameter, Aluminum alloy, with friction stop mechanism
DEC Axis	59mm in diameter, Aluminum alloy, with friction stop mechanism
Number of Bearings	7 pieces
Counterweight Bar	20mm (8") diameter, Steel
Polar Alignment Scope	Optional
Azimuth Adjustment	Fine adjustment range: +/- 6.5 degrees, 1.4 degrees per rotation, Twin adjustment screws with knobs
Altitude Adjustment	Latitude adjustment range: 0 degree to 65 degrees, Tangent screw with handle, 1.9 degrees per rotation
Motor Drive	Pulse (Stepping) Motor
Tracking	High precision tracking with STAR BOOK ONE controller
Maximum Loading Weight	6kg (13.2 lbs) (150kg · cm torque load) at a point of 25cm from the fulcrum
Controller Cable Connecting Port	D-SUB 9PIN male plug
Power Supply Port	USB Micro-B (DC4.4 to 5.26V)
Power Supply	4 x AA batteries (Alkaline or Ni-MH, Ni-Cd rechargeable batteries), External USB battery pack (Not sold by Vixen)
Working Duration with Batteries	About 4 hours (at 20 degree C, with Alkaline batteries, 6kg loading weight ), 2.5 hours if the DEC motor module is used together.
Electricity Consumption	DC5V · 0.2 ~ 0.5A (1.0 ~ 2.5W) , 0.3 ~ 1.0A (1.5 ~ 5.0W) if the DEC motor module is used together.
Fuse	125V 1A Class B (PSE standard), 6mm dia x 30mm long
Dimensions	274 x 310 x 96mm (11" x 12" x 3.7")
Weight	3.9kg (8.5 lbs) without counterweight
Counterweight	1.0kg (2.2 lbs)
Optional Accessories	DEC motor module, APP-TL130 tripod, PG mount head unit, Polar alignment scope PF-LII, Polar Meter

**Controller Specifications**

Controller	STAR BOOK ONE
CPU	32-bit CISC Processor 40MHz RX210
LCD Screen	2-line 8-character STN with backlight
Autoguider Port	6-pole 6-wired modular jack (for external autoguider)
Controller Cable Port	D-SUB 9PIN male plug
Power Supply	Supplied from the mount side
Operating Temperature	Between 0 degree C and 40 degree C (104 F)
Dimensions	137 x 65 x 21mm (5.4" x 2.5" x 1")
Weight	110g (4 oz) (without cable)
Menus and Major Functions	Sidereal tracking rate (variable from 0.1X to 10X by step), Solar tracking, Lunar tracking and Kings rates, Backlash compensation, PEC, External autoguider connection, Adjustable LED backlight, Red LED Light

The specifications are subject to change without notice.

## BEFORE USE

### Mount Specifications

#### Mount Head

The mounting block is designed to attach an optical tube with dovetail tube plate (or dovetail slide bar). The optical tube is firmly fixed with both the lock screw with large grab knob and safety screw. This allows quick set up and removal of the optical tube.

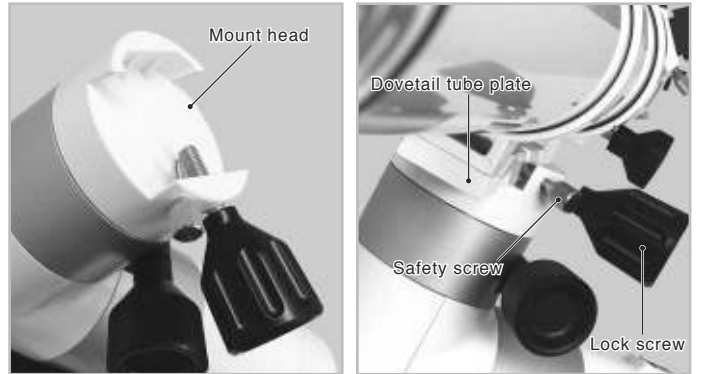

#### Counterweight Bar

The optical tube mounted on the equatorial mount has to be balanced with a counterweight to use the equatorial mount properly.

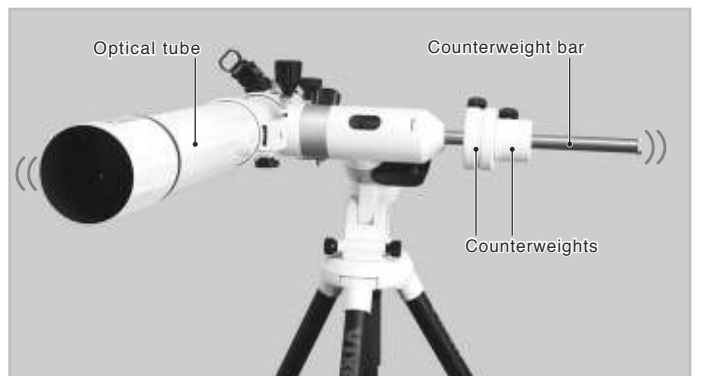

#### Right Ascension (R.A.)

If the AP mount is set to be aligned with one rotational axis parallel to the Earth's axis, the motion of R.A will follow the motion of stars.

#### Declination(DEC)

If the AP mount is set to be aligned with one rotational axis parallel to the Earth's axis, the motion of DEC will be angled to the motion of the R.A.

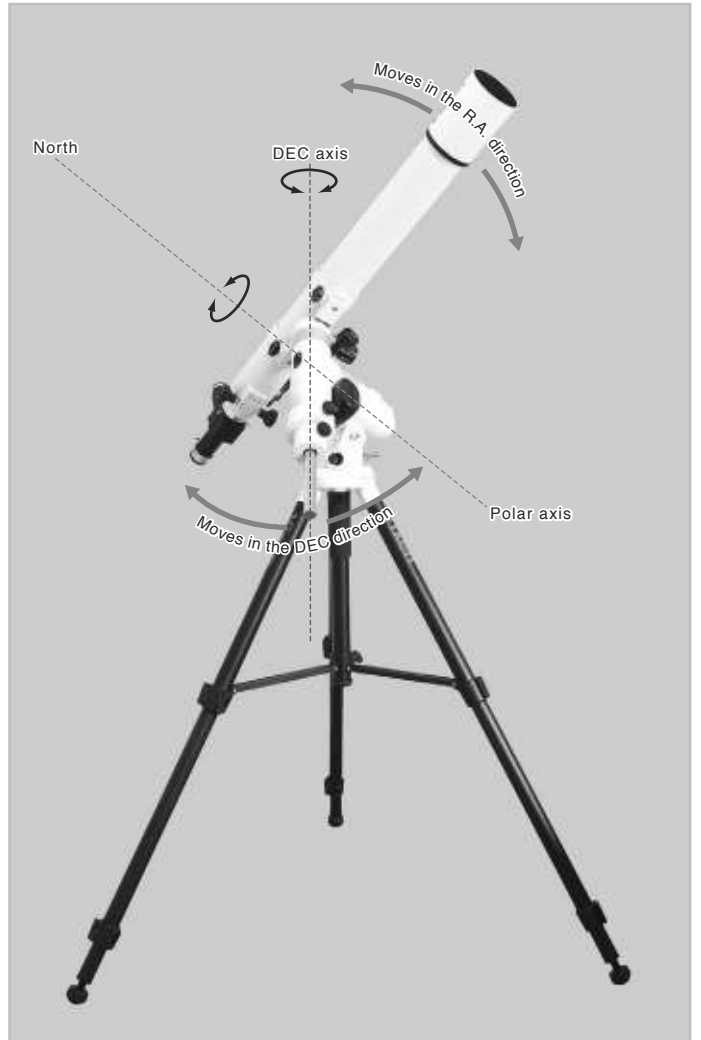

## BEFORE USE

### Friction Stop Mechanism

The AP mount employs a friction stop mechanism which allows you to move the optical tube by hand so that you can quickly point it at your target celestial object. The optical tube moves as you guide it by hand and stops as you release.

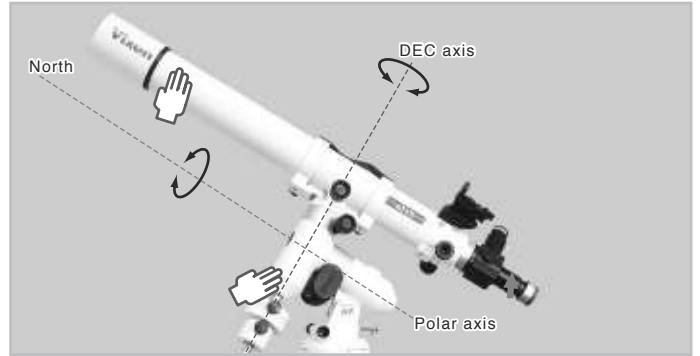

### Altitude Adjustment Bolt

This is used for polar alignment during your set up for observation. It is used to adjust the elevation of the polar axis to be parallel to the Earth's axis.

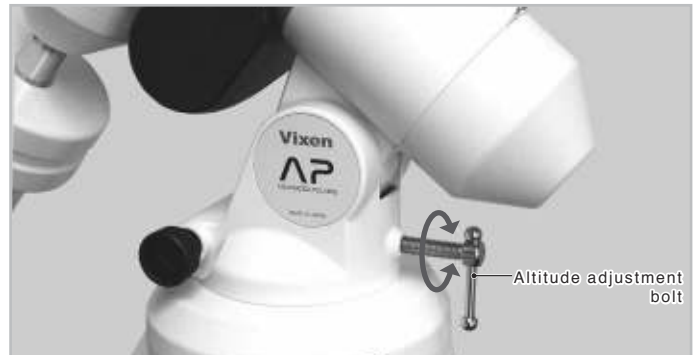

### Azimuth Adjustment Knobs

This is used for polar alignment during your set up for observation. Adjust the direction of the polar axis to be parallel to the Earth's axis. Unfastening one side of the azimuth adjustment knob will allow fastening the knob on the other side.

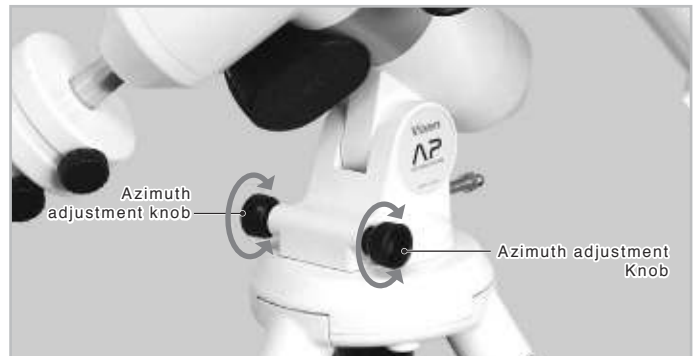

### Accessory Shoe

Attach an optional Polar Meter sold separately. It will allow you to approximately align the AP mount to the North Pole, if Polaris is not seen from your observing site in the northern hemisphere.



### Power Supply Port

The AP-SM mount runs on self-contained four (4) AA –size batteries, or a USB external battery. The USB external battery with USB micro-B adapter will be needed for long observing sessions.



# BEFORE USE

## STAR BOOK ONE Components Guide

Note: Usage of the STAR BOOK ONE is described as operating instructions for the AP-SM Mount here.

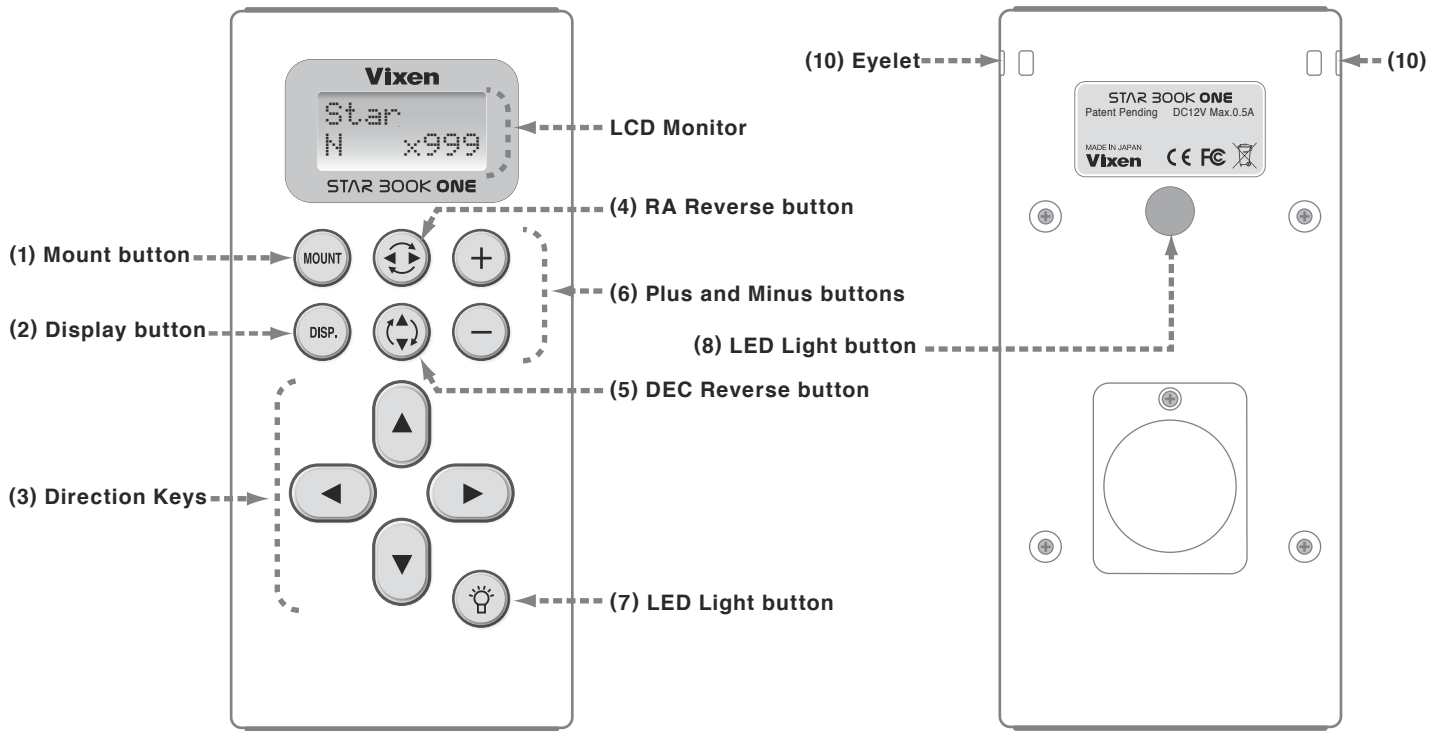

	<p><b>(1) Mount button</b></p> <p>Set up menus for the mount such as tracking mode and backlash compensation. Pressing the Mount button turns up the brightness of the button itself and allows you to change the settings with the direction keys. Press the Mount button again to leave the menu and the brightness dims. The new setting is saved as you enter the new value. (Your recorded PEC data are for temporary use and not saved when you turn off the mount.)</p>
	<p><b>(2) Display button</b></p> <p>Set up menus for the controller such as language and backlight adjustments. Pressing the Display button turns up the brightness of the button itself and allows you to change the settings with the direction keys. Press the Display button again to leave the menu and the brightness dims. The new setting is saved as you enter the new value.</p>
	<p><b>(3) Direction Keys</b></p> <p>You can move your telescope in the RA and DEC directions with these keys. Pressing any of the four direction keys will accelerate the motor speed toward the maximum value you selected. (The DEC direction keys will be inoperative if the single-axis drive is applied to the AP-SM mount.) Then, that speed is maintained while the key is being pressed. The motor speed is decelerated if you stop pressing the key. The Direction keys function as menu selection buttons to change the settings while the Mount button or Display button is selected and lit.</p>
	<p><b>(4) RA Reverse button</b></p> <p>The tracking direction of the RA can be reversed to have the orientation of your eyepiece's field of view change to the opposite direction. Pressing the RA Reverse button turns up the brightness of the button itself and the button will function. Pressing the button again will change the orientation of the telescope to the original direction, and will turn down the brightness of the button as you leave the menu.</p>
	<p><b>(5) DEC Reverse button</b></p> <p>The tracking direction of the DEC can be reversed to have the orientation of your eyepiece's field of view change to the opposite direction. (The DEC reverse button will be inoperative if the single-axis drive is installed on the AP-SM mount.) Pressing the DEC Reverse button turns up the brightness of the button itself and the button will function. Pressing the button again will change the orientation of the telescope to the original direction, and will turn down the brightness of the button as you leave the menu.</p>

	<p><b>(6) Plus and Minus buttons</b></p> <p>Use these buttons to set up the maximum slewing speed of the telescope. The Plus and Minus buttons function as menu selection buttons to change settings as long as the Mount button or Display button is illuminated.</p>
	<p><b>(7) LED Light button</b></p> <p>There is a built-in red LED light on the back of the STAR BOOK ONE. The red light is switched to ON or OFF alternatively each time the button is pressed. The red light stays lit while you continue pressing the LED light button and the light goes off as you release the button.</p>
<p><b>(8) LED Light button</b></p> <p>A 2 line (8 character each line) information screen with adjustable backlight.</p>	
<p><b>(9) Red LED Light</b></p> <p>The built-in red LED light on the back of the STAR BOOK ONE is useful to keep your eyes acclimated to darkness at an observation site when you want to avoid white light.</p>	
<p><b>(10) Eyelet</b></p> <p>The eyelet hole is for a strap. The eyelets are provided on either side of the controller.</p>	

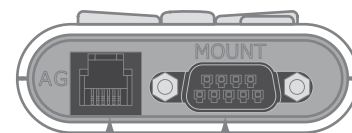

(11) Autoguider Port --- (12) Mount Connecting Port

<p><b>(11) Autoguider Port</b></p> <p>Compatible with the SBIG autoguider's connection port. Designed for 6-pole 6-wired modular jack.</p>
<p><b>(12) Mount Connecting Port</b></p> <p>A connecting port to connect between the AP mount and the STAR BOOK ONE. Designed for D-SUB9PIN.</p>

## PREPARATION

### Assembling the Mount

Refer to the instruction manual of your telescope and accessory together with this manual when you attach the optical tube assembly to the mount.

⚠ The unit includes heavy items. Take care not to drop them when assembling as it could cause serious damage to the equipment or lead to injury.

⚠ Take care not to pinch your finger with moveable pieces when setting up.

### Setting up the Tripod

**1** Place the tripod on level ground to make the telescope stable during observation.

**2** Unfasten the extension lock lever on the tripod leg by pulling it out so that the tripod leg can be adjusted. To keep better stability, extend the upper section of the tripod legs first. Pull out the tripod legs until each leg comes to your desired length.

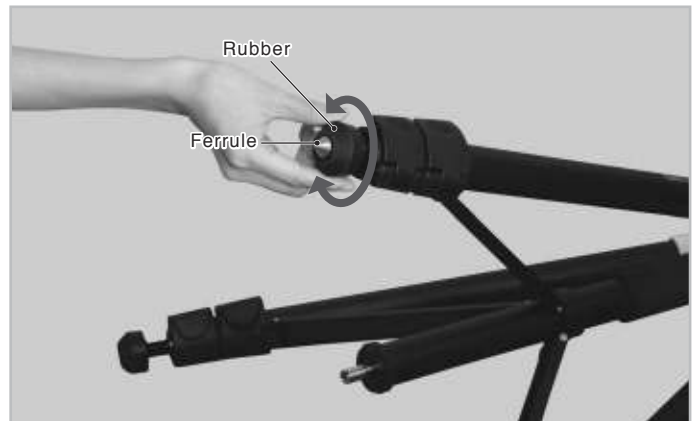

**3** Fasten the extension lock lever to hold the tripod leg securely in place.



**4** Loosen the lock screw on the leg brace and pull the tripod legs apart until the leg brace is fully extended.



## PREPARATION

- 5** Attach the metal post on the tripod head. The metal post is underneath the center column. Be sure to screw down the metal post completely

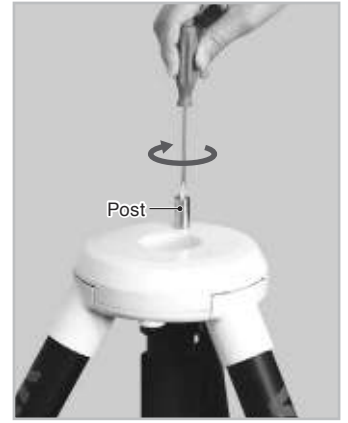
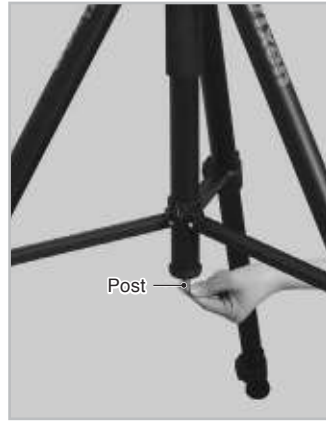

- 6** Loosen the azimuth adjustment screws in advance by turning the azimuth adjustment knobs on the mount base so that a space is opened for the metal post between the screws.

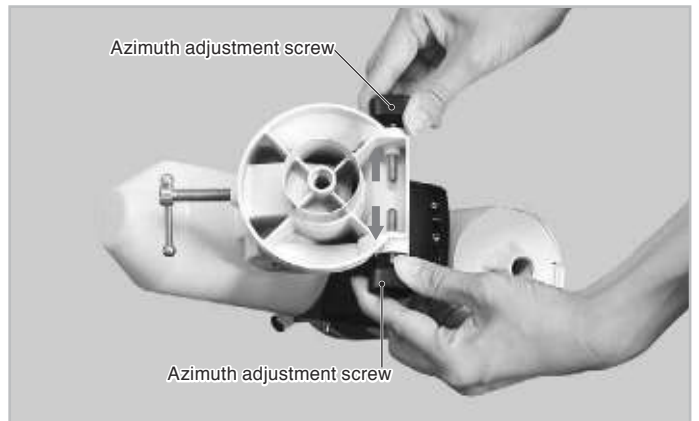

- 7** Position the mount so that the two azimuth adjustment screws come above the metal post. Place the mount on the tripod head so that the center projection on the bottom of the mount fits the center hollow on the tripod head.

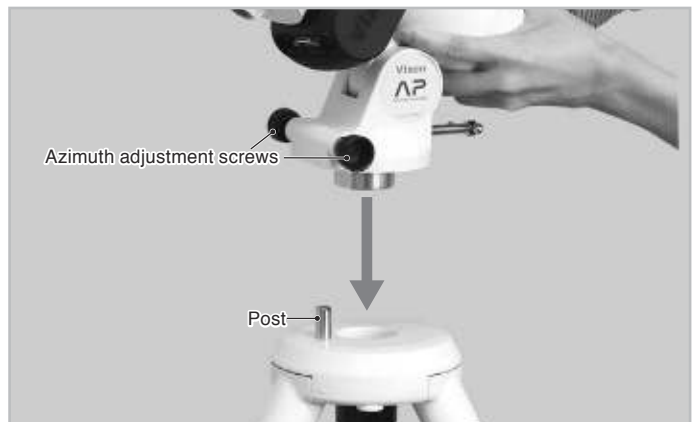

- 8** Holding the mount with one hand, raise the center column with the hand so that the top of the column is fit the bottom of the mount. Turn the center column counter-clockwise to screw the top of the column into the bottom of the mount until secure.

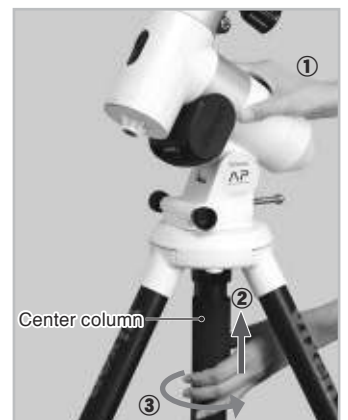



## PREPARATION

- 9** Tighten the azimuth adjustment knobs on the mount base so that the two knobs are equally tightened.



- 10** Push down the leg brace until it clicks as to secure the stability of the tripod. Tighten the leg brace lock screw securely.

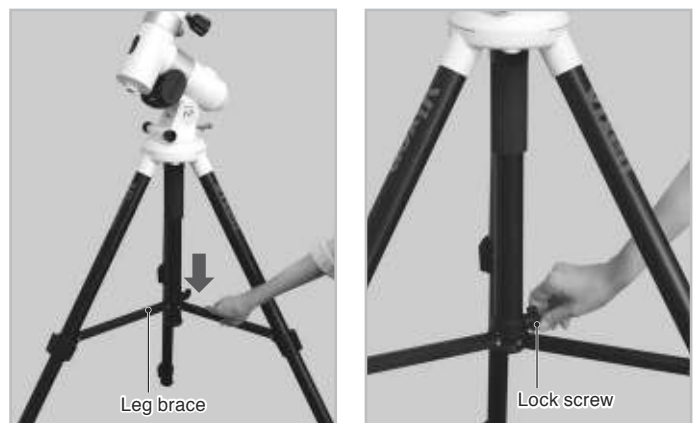

- 11** Repeat the above procedure when you change the height of the tripod.

- 12** Attach the Slow Motion Control Knobs  
The slow motion control knob is attached onto the worm screw by push fit. Place the manual slow motion control knob on the tip of the worm screw shaft so that the flat portion of the socket on the knob is joined with the flat portions of the tip on the shaft. For the AP-SM mount, attach the the slow motion control knob to the DEC worm screw shaft only.

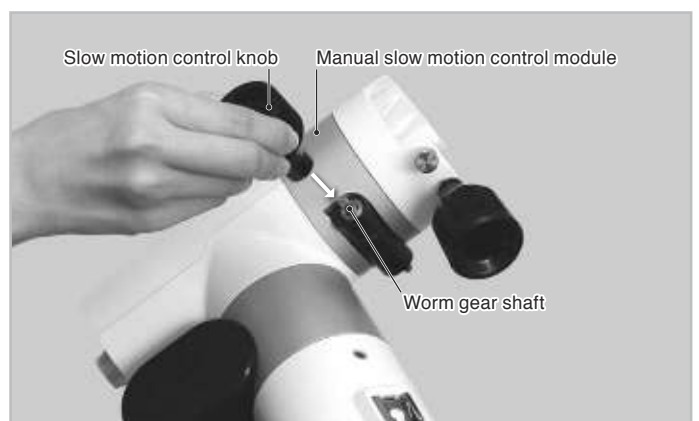
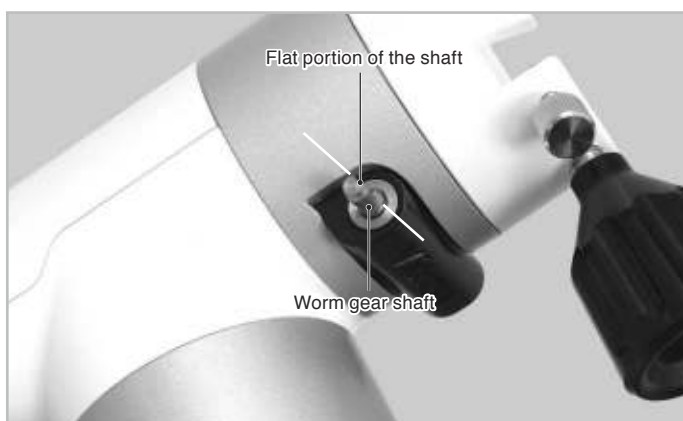
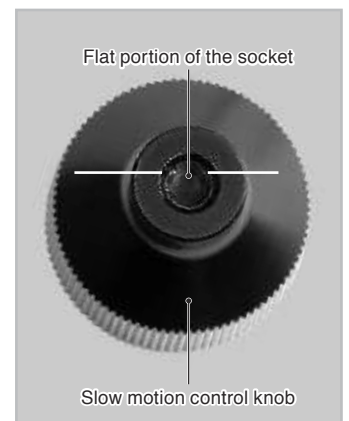

## PREPARATION

### Attaching the Counterweight

⚠ Be sure to attach the counterweight before you install the optical tube assembly on the mount.

- 1 Screw the counterweight bar into the vanity ring until it is snug. Then, turn it back by one rotation.

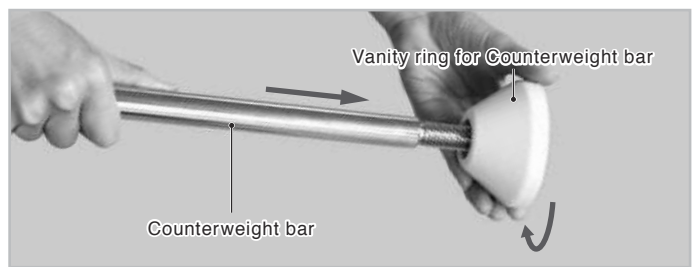

- 2 Screw down the counterweight bar into the declination body fully and tighten the vanity ring securely.

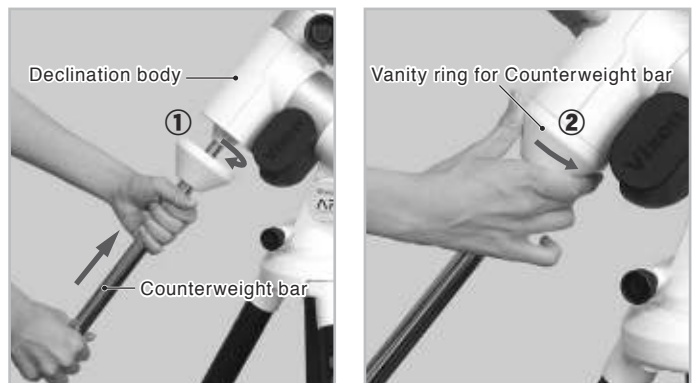

- 3 Remove the safety screw on the end of the counterweight bar.

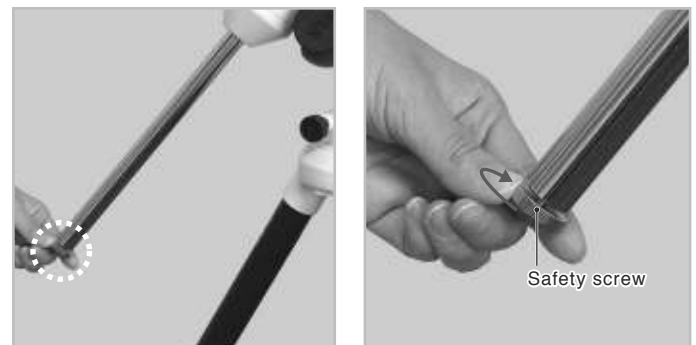

- 4 Make sure that the counterweight bar is at the lowest position and attach the counterweight. Loosen the lock knob on the counterweight and put through the counterweight so that the lock knob is on the far side of the end of the counterweight bar. At this stage the counterweight should be close to the end of the counterweight bar to lower the center of the balance. Tighten the lock knob.

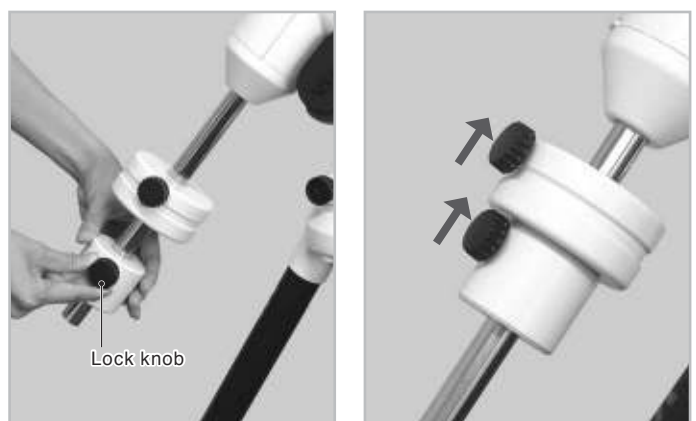

⚠ Note: Make sure that the lock knob is tightened firmly before you release your hand from the counterweight.

- 5 Replace the safety screw on the end of the counterweight bar and tighten it.



## PREPARATION

### Attaching the Optical Tube Assembly

The telescope tube attaches to the AP mount via a dovetail tube plate. The permissible loading weight of the mount is 6kg (13.2 lbs).

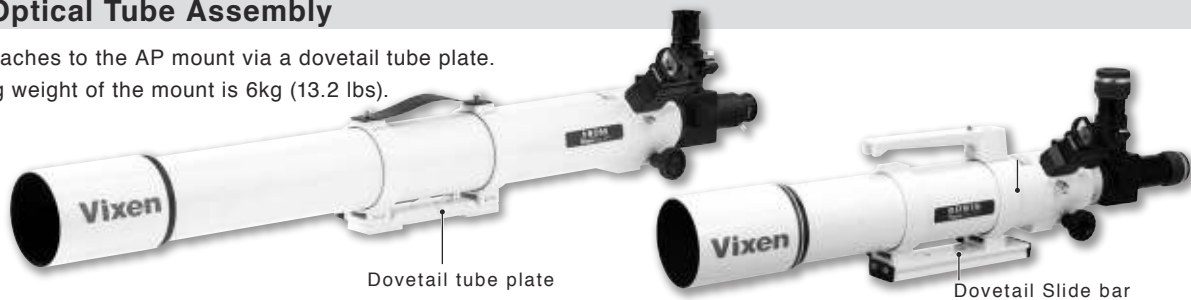

⚠ **Caution:** Take care not to drop the telescope tube as it could result in serious damage.

- 1 Loosen both dovetail plate lock screw and safety screw on the mount head fully so that space is available to insert the dovetail tube plate.



- 2 Attach the telescope tube to the mount head so that the dovetail tube plate fits securely into the sunken mount head. Tighten the dovetail plate lock screw first onto the dovetail tube plate centering notch until it is snug. Then, tighten the safety screw securely.

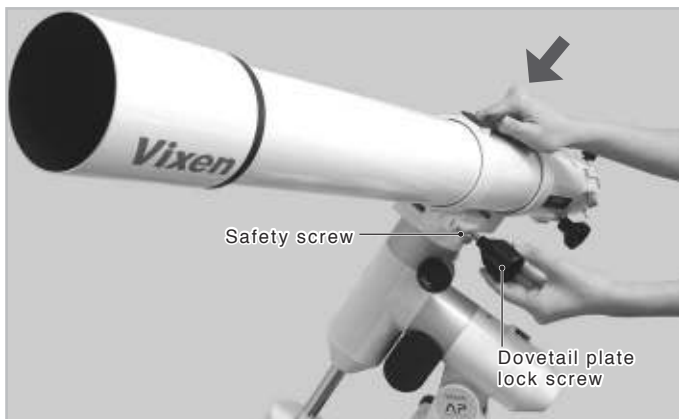

⚠ **Note:** Make sure that the dovetail tube plate is flat against the mount head.

Tightening the dovetail plate lock screws with a gap between these parts may cause the telescope tube to fall.



## PREPARATION

### Attaching the Dovetail Slide Bar

### AP Photo Guider

- 1 Loosen both the dovetail plate lock screw and safety screw on the mount head fully so that space is available for the dovetail slide bar.

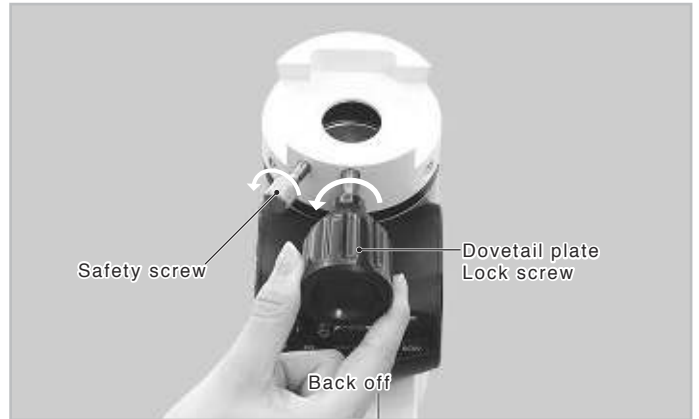

- 2 Attach the dovetail slide bar to the mount head so that the dovetail slide bar fits securely into the sunken mount head. Orientate the dovetail slide bar as shown in the figure to prevent the dovetail slide bar from falling. (The dovetail slide bar has a stopper screw on one side of the dovetail rail.) Attach the dovetail slide bar so that the tip of the dovetail plate lock screws hits on another part of the dovetail rail with no stopper screws.

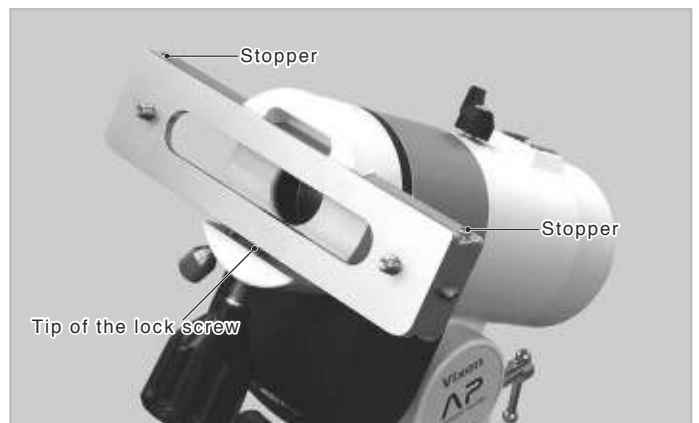

- 3 First tighten the dovetail plate lock screw onto the dovetail slide bar centering notch until it is snug. Then, securely tighten the safety screw.

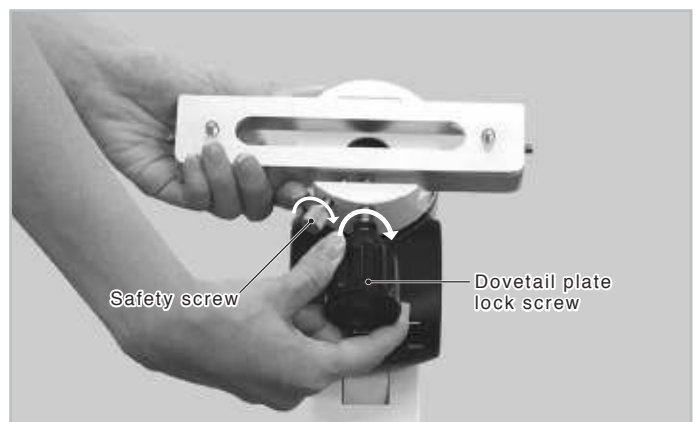

### About the orientation of the mount head unit

The mount head unit is attached onto the head of the polar axis body assembly with three set screws that are equally put on its side.

The set screws can be loosened with the 4mm Allen wrench to change the position of the mount head to point at your desired orientation.

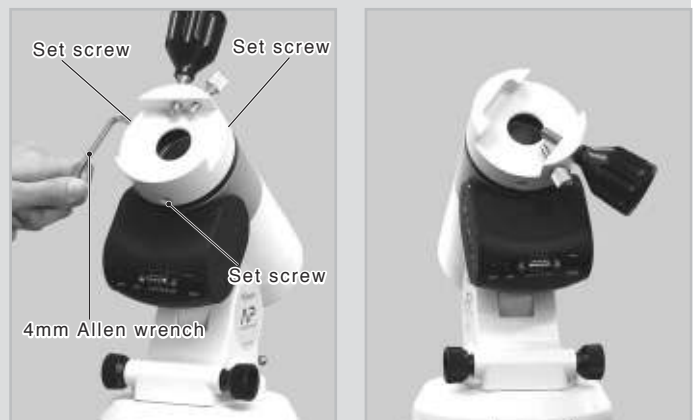

## PREPARATION

### Balancing the Equatorial Mount

The Vixen AP is a German equatorial mount, in which the rotating R.A axis and rotating DEC axis cross each other at a right angle. The axes are rotated by using the movement of both axes to get maximum stability and limit the stress on the gears. If the equatorial mount is in an unbalanced state, it will increase stress to the gears and this could result in larger consumption of electricity or erratic operation.

The AP mount employs a friction stop mechanism in the motion of the R.A and DEC axes. It will tend to slip while rotating if used in an unbalanced state. It is necessary to adjust the balance to bring the center of balance onto the R.A and DEC axes respectively for a comfortable operation of the telescope.

### ⚠ Caution

Take care not to drop the optical tube assembly as it could seriously damage the equipment or lead to injury. Pay close attention to the security of the telescope tube and do not excessively loosen the lock knobs on the equipment.

### First Step: Balancing the Mount in Right Ascension (R.A)

- 1 While holding the counterweight bar, turn the declination body by hand until the counterweight bar is horizontal.

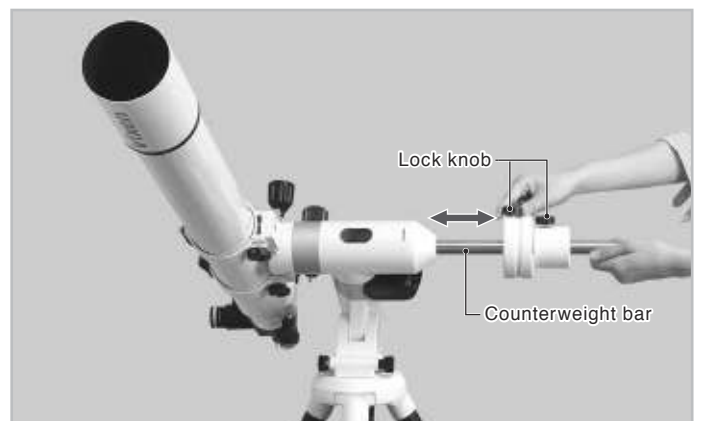

- 2 Release the counterweight bar slowly to see if the declination body remains in place. If the declination body starts turning as you release the counterweight bar, you will need to shift the counterweight on the counterweight bar until the mount is in balance.

- 3 Loosen the lock knob on the counterweight and slide it gradually to the point at which the declination body remains stationary. Tighten the lock knob on the counterweight to hold in place.

Note: Do not slide the counterweight too much in balancing. This could damage the telescope tube or lead to injury.

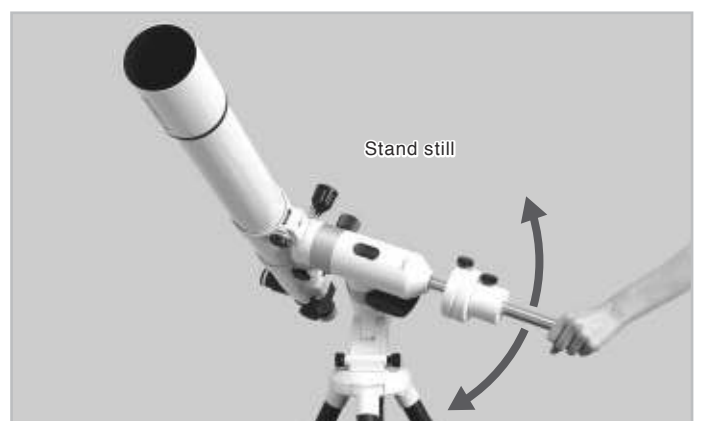

## PREPARATION

### Second Step: Balancing the Mount in Declination (DEC)

This should be done after you finish balancing in the R.A.

#### In case of a telescope tube with tube rings:

- 1 While holding the telescope tube, turn the counterweight bar (or telescope tube) by hand until the counterweight bar is horizontal. The declination body keeps the mount in position.

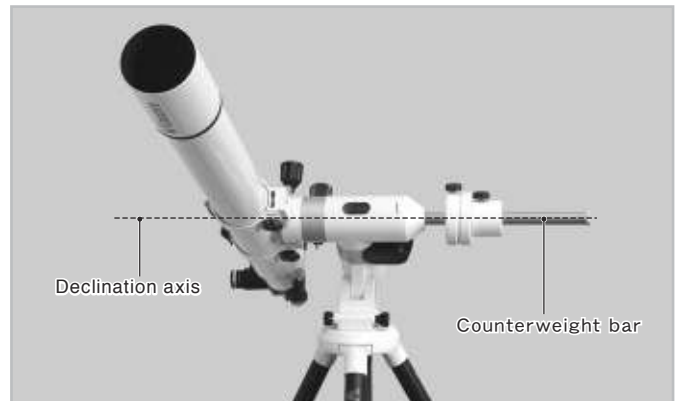

- 2 Release the telescope tube slowly to see if it remains in place. If the telescope tube starts turning as you release it, you will need to shift the telescope tube until it is balanced and remains in place.

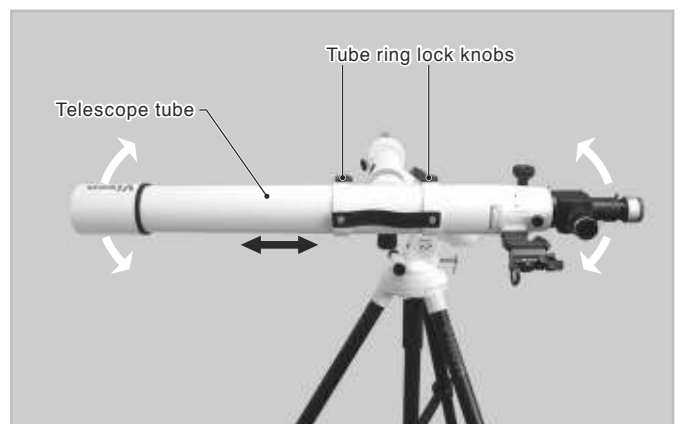

#### ⓘ Note:

Do not loosen the tube ring lock knobs too much in balancing. This could cause telescope tube to fall and lead to injury.

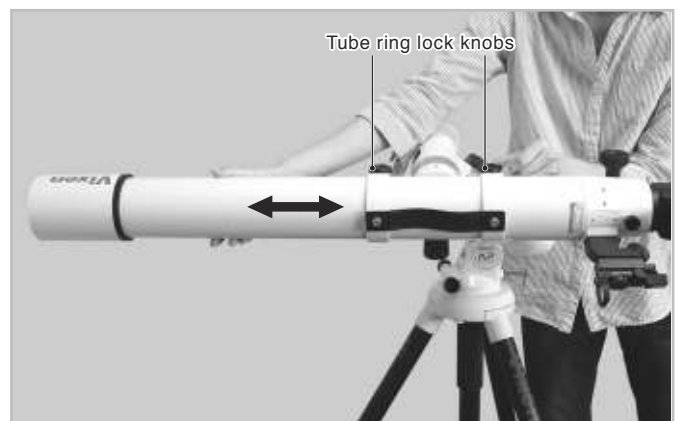

- 3 Loosen the lock knobs on the tube rings that hold the telescope tube and slide the telescope tube either forward or backward until it remains stationary.

- 4 Tighten the tube ring lock knobs securely to hold the telescope tube in place.



## PREPARATION

### Using a telescope tube with dovetail slide bar:

This should be done after you finish balancing in the R.A.

- 1 While holding the telescope tube, turn the counterweight bar (or telescope tube) by hand until the counterweight bar is horizontal. The declination body keeps the mount in position.



- 2 Release the telescope tube slowly to see if it remains in place. If the telescope tube starts turning as you release it, you will need to shift the telescope tube either toward or backward until it remains stationary.

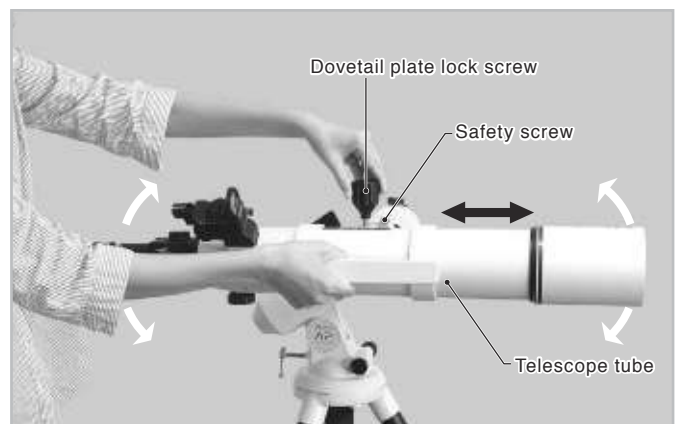

#### ⚠ Note:

Do not loosen the dovetail lock screw and safety screw too much in balancing. This could cause telescope tube to fall and lead to injury.

- 3 Slightly loosen the dovetail lock screw and safety screw that hold the telescope tube on the dovetail slide rail, and slide the telescope tube either forward or backward until it remains stationary.

- 4 Tighten the dovetail lock screw and safety screw securely to hold the telescope tube in place.



# PREPARATION

## Tips on Proper Balancing

The balance arrangements below illustrate various possible settings dependent on the length and weight of your optical tube. The center of gravity of the telescope is given as 25cm (10") from the intersection of the R.A and DEC axes.

### Guidance

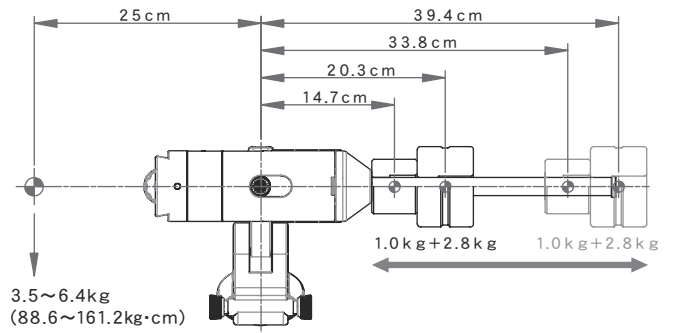
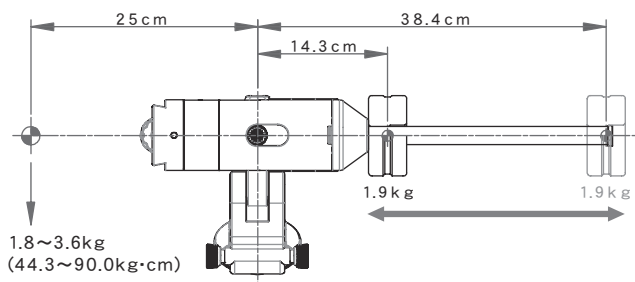
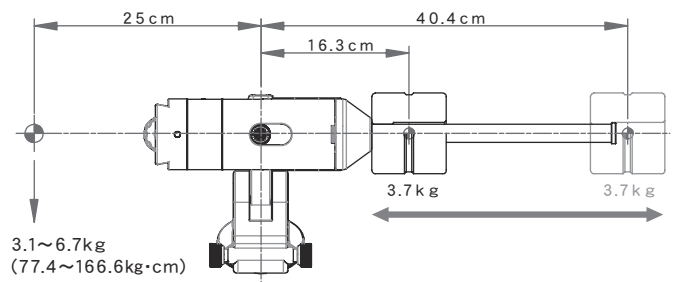
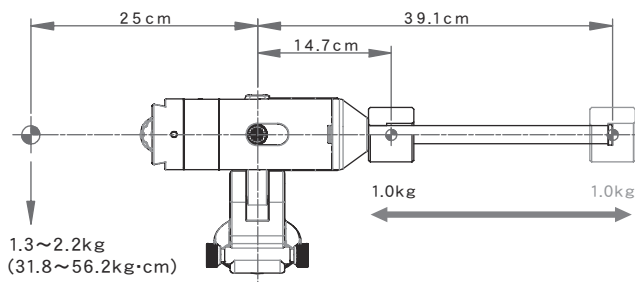
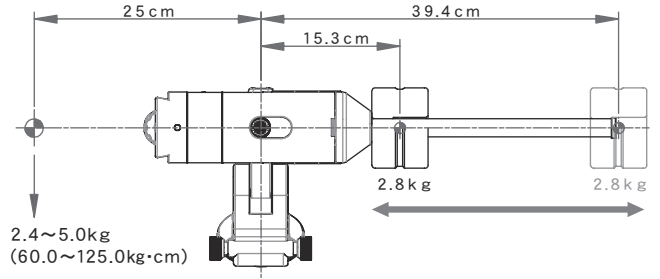
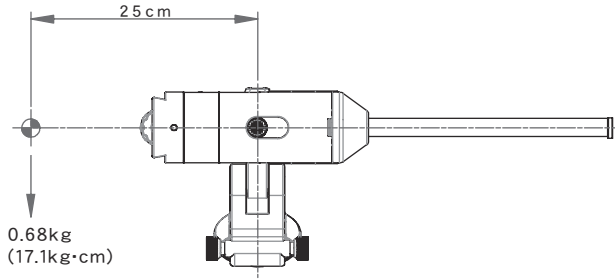



## PREPARATION

### Connecting the STAR BOOK ONE

The AP-SM mount package comes equipped with an RA motor module and STAR BOOK ONE controller as standard accessories.

- 1 Plug one end of the STAR BOOK cable into the connection port on the mount.

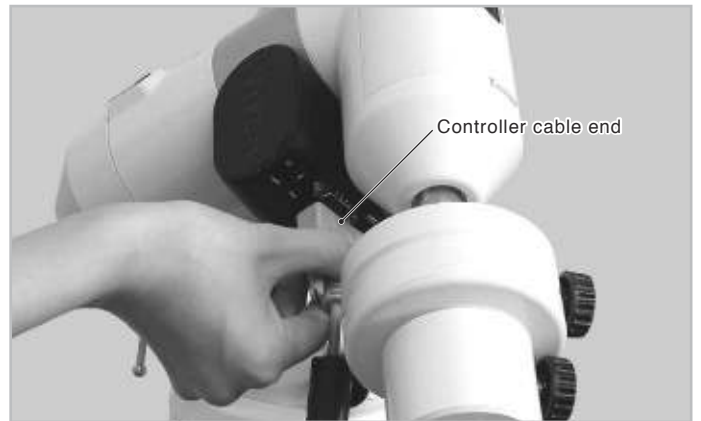

- 2 Secure the connectors with the fixing screws.



- 3 Plug the other end of the STAR BOOK cable into the connection port on the STAR BOOK ONE.



- 4 Secure the connectors with the fixing screws.

Note 1: Hold the connector part of the STAR BOOK cable securely and pull it straight out when you unplug the cable. Unplugging by grabbing the cable part may cause a wire to break.

Note 2: Avoid pulling or bending a part of the cable adjacent to the connectors. It may cause a wire to snap.

Note 3: Never connect the STAR BOOK cable to other equipment such as a PC. It may cause failure, fire or electrical shock. (The STAR BOOK cable does not meet the RS232C specifications.)

## PREPARATION

### About Power Supply

The AP-SM mount runs on self-contained four (4) AA –size batteries, or a USB external battery. The AC Adapter 12V-3A for SX mount is not available for the AP-SM mount.

### Installing AA-size Batteries

The AA –size alkaline batteries or Ni-MH or Ni-Cd AA rechargeable batteries are recommended.

**1** Remove the battery compartment cover on the declination body.

Open up the cover of the for polar scope window on the declination body. Push down on the hook on the body and pull out the declination body cover by pinching the hook and window hole with fingers.

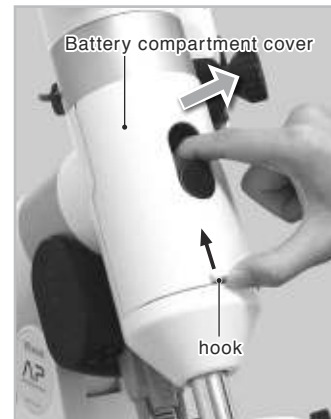

**2** Insert four AA batteries to the battery compartment inside the declination body. Be sure to check the polarity of the batteries.



**3** Replace the batteries compartment cover.



Note 1: If the batteries are drained (its voltage power is dropping), the display on the STAR BOOK ONE begins to blink. If this happens, exchange the batteries for new ones (or fully recharged ones).

Note 2: Use AA batteries of the same rating. Do not mix new batteries and old batteries. This could cause leakage of battery fluids.

## PREPARATION

### Using a USB External Power Supply

Use a commercially available USB external battery with USB Micro-B connector.

**Note 1:** The USB external battery will take priority over the AA batteries if you turn on the power while the AA batteries remain in the battery compartment.

**Note 2:** Be sure to turn off the power when you remove the USB external battery while the AA batteries remain in the battery compartment. Although this does not lead to damage, it may cause an operation error or initialize your settings on the STAR BOOK ONE.

**Note 3:** If the USB external battery is drained (its power voltage is dropping), the display on the STAR BOOK ONE begins to blink. If this happens, exchange the USB external battery for new ones (or fully recharged ones).

**Note 4:** When you unplug the power cable, be sure to hold the connector part and pull it straight out. Unplugging by grabbing the cable part may cause a wire to snap.

**Note 5:** Avoid pulling or bending a part of the power cable adjacent to the connectors. It may cause a wire to snap.

**Note 6:** Do not use the power cable in a folded and tied condition. It may cause electrical shock or fire.



# INITIAL SETTING AND BASIC OPERATION

## Turning ON the Power

1 The power switch is located on the bottom of the R.A motor module if you have the AP-SM mount version.

To turn on the power, press the side marked "I" on the switch, and to turn off the power, press the "O" side on the switch.

Note: The mount starts celestial tracking as soon as the power is ON although it seems to remain stationary.



2 The initial screens below appear on the display of the STAR BOOK ONE as you turn on the power switch.



Legend

[Star]: Sidereal tracking rate

[N]: Northern hemisphere

[x60]: Maximum speed of the direction key  
(multiple proportions of sidereal rate)

## Setting Language

1 Pressing the Display button illuminates that button and the setting screen\* is displayed.



\*The setting screen used with the last setting will appear if you press the button.  
First, designate the language you use.

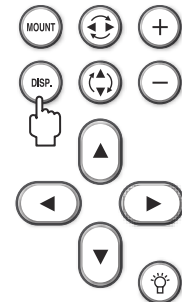

2 In the setting screen, choose "Language" with the left or right direction key.



The setting is defaulted to "English"

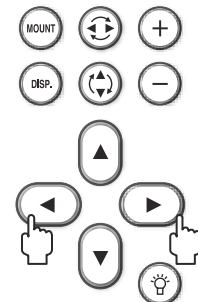

3 You can choose "Japanese" language with the up or down key (or plus or minus button also).

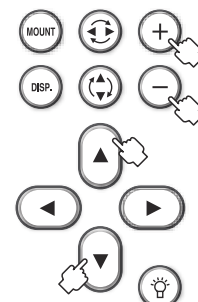

# INITIAL SETTING AND BASIC OPERATION

## Basic Operation of the AP Equatorial Mount

### Moving the AP Mount

The AP Mount is designed to move and stop the rotational axes without a clamp system. The tracking and slow motion control are done with the manual slow motion control knobs.

### Moving the AP-SM Mount or AP Photo Guider

Both the AP-SM Mount and AP Photo Guider come with the R.A. motor module as standard. The tracking and slow motion are controlled by the supplied STAR BOOK ONE controller in the direction of the R.A. Addition of an optional DEC motor module will allow you to move the R.A and DEC axes with the STAR BOOK ONE.

Note: Usage of the STAR BOOK ONE is described as operating instructions for the AP-SM Mount here. You may occasionally find wording not relevant to the AP Photo Guider.

- 1 Turn the power switch ON to start tracking with the R.A. motor module.

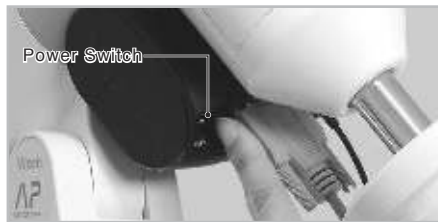

- 2 Move the mount freely while holding the optical tube by hand so that you can change the telescope's pointing direction.

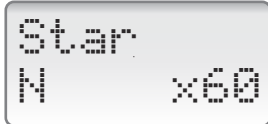
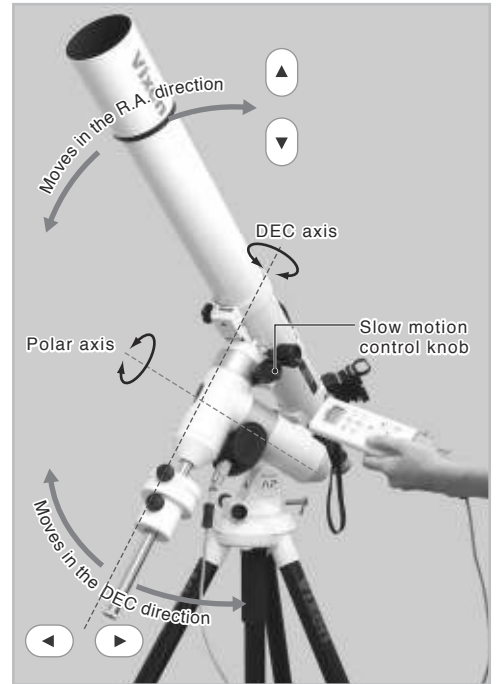

Note: The up and down keys are inoperative unless an optional DEC motor module is installed on the AP-SM mount. Use the slow motion control knob to move the mount slowly in the direction of the DEC.

### Changing the Slewing Speed

Move the mount at different speeds through use of the direction keys.

While both the Mount and Display buttons are inactive with no illumination, pressing the Plus button will accelerate the slewing speed and pressing the Minus button will decelerate the slewing speed.

Default slewing speed: 60x of the sidereal rate at a maximum, and it can be slowed down to 30X, 1.0X and 0.5X of the sidereal rate. The slewing speed can be changed between 0.1X and 60X of the sidereal rate.

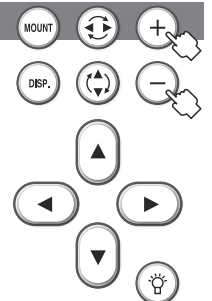

	<p><b>X60</b></p> <p>Choose this option when you make a large change to the direction of the mount in combination with the friction stop.</p>
	<p><b>X30</b></p> <p>Use this option when you bring your target object in the crosshairs in the field of view of the finder scope. The mount moves slowly.</p>
	<p><b>X1.0</b></p> <p>Choose this option when you correct a position of the object in the field of view of the telescope as it makes you move the mount very slowly.</p>
	<p><b>X0.5</b></p> <p>Choose this option when you use the telescope with high magnification. The mount moves extremely slow.</p>

## INITIAL SETTING AND BASIC OPERATION

### Changing Tension of the Friction Stop Motion

The tension of the friction stop motion can be adjusted in the R.A and DEC axes as the need arises. The position of each tension adjustment screw for the R.A and DEC axes is shown in the figure.

Adjust the tension of the friction stop motion by loosening or tightening the tension adjustment screws with the supplied 4mm Allen wrench.

Be sure to loosen the tension adjustment screw with holding the optical tube as it may quickly affect the balance.



# INITIAL SETTING AND BASIC OPERATION

## Approximate Polar Aligning with the Finder Scope

After setting up the telescope, locate the AP mount so that its R.A axis points toward the north celestial pole.

In this section an approximate Polar alignment using a finder scope is described for observers in the northern hemisphere. The finder scope on your telescope must be aligned accurately before you start aligning the mount. In the southern hemisphere, use of an optional Polar alignment scope is recommended.

**1** Point the mount toward the north celestial pole in the northern hemisphere as shown in the figure.

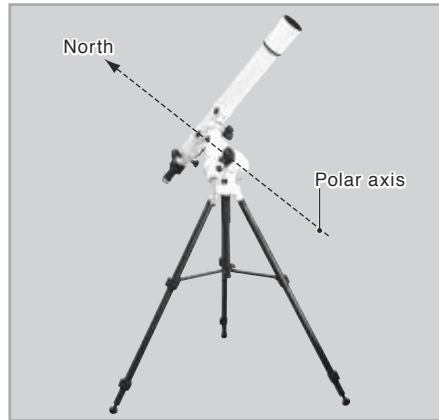

**2** Position the telescope tube so that it points toward the north.

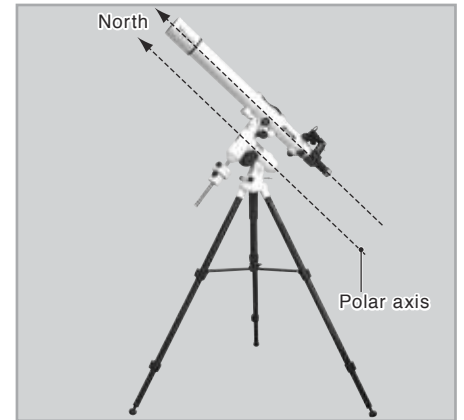

**3** While looking for Polaris in the finder scope's field of view, adjust the mount with the azimuth adjustment knobs and altitude adjustment bolt on the mount base so that Polaris comes to the center of the finder scope's field of view (an intersection point of the crosshairs).

Turn the altitude adjustment bolt so that the elevation of the R.A axis matches the latitude of your observing site.

Turn the azimuth adjustment knobs so that Polaris comes to the center. Loosening the azimuth adjustment screw on one side will allow you to tighten the screw on the other side. Thus the direction in azimuth can be changed.

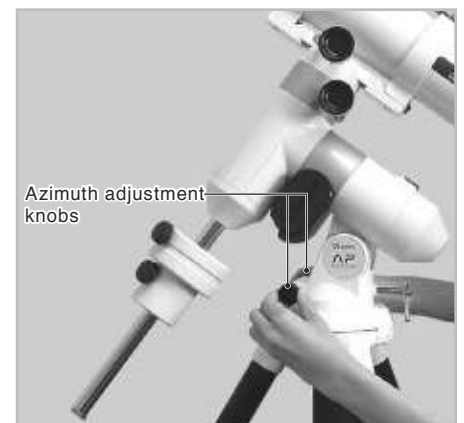
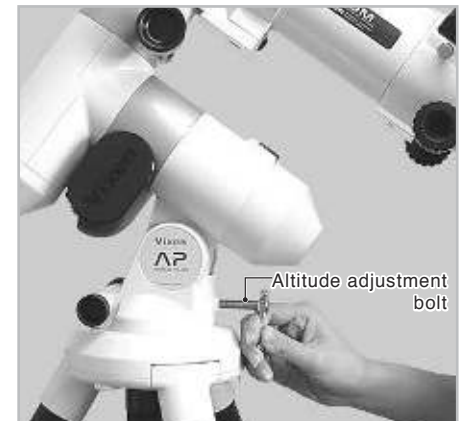

**4** Bring Polaris into the center of the finder scope's field of view.

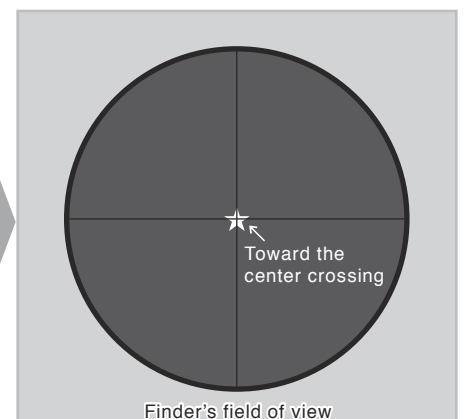
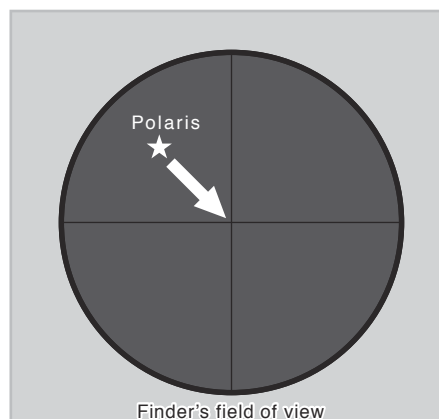

## INITIAL SETTING AND BASIC OPERATION

### Find Polaris from Cassiopeia and the Big Dipper

A rough setting with a compass or pointing the polar axis of your telescope's mount at Polaris will work well for visual observation. The constellations Cassiopeia and the Big Dipper (part of Ursa Major) are near Polaris. You will be able to find Polaris if you know the position of these groups of stars. Cassiopeia and the Big Dipper are autumn and spring constellations respectively. For most of the year either constellation is always above the eastern or western horizon.

Find Polaris using the guide map below.

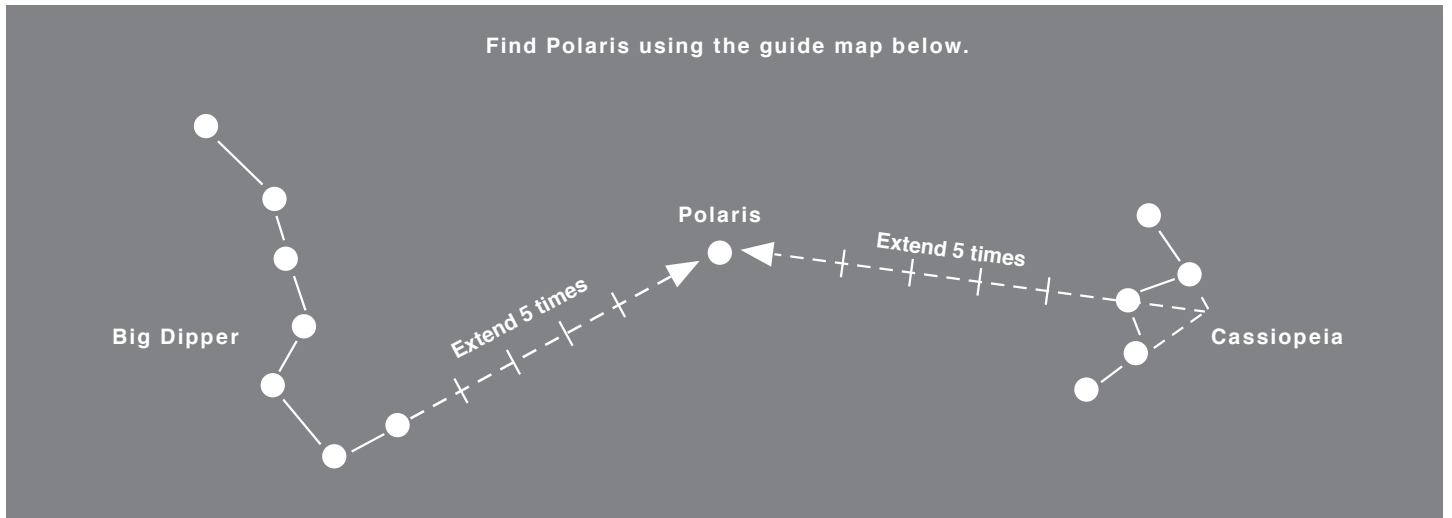

#### Directions 1:

Locate the two stars that form the outer edge of the Big Dipper as shown in the above map. Draw an imaginary line straight through the two stars of the dipper edge. You will see Polaris equidistant between the constellations.

#### Directions 2:

Cassiopeia looks like the letter "W" or the letter "M" depending on when you observe it. Draw imaginary lines from the stars that form the outer edges of the letter "W" so that the two lines intersect. Draw an imaginary line from the center of the "W" through the cross point of your first line. Extend it straight through by about 5 times to get to Polaris.



## INITIAL SETTING AND BASIC OPERATION

### Approximate Polar Alining with the Polar Meter

The Polar Meter is optional and it is not included in the AP Mount packages.

- 1 Loosen the angle lock knob of the Polar Meter and tilt it to an angle that is equal to the altitude of Polaris at your location. Then, tighten the angle lock knob.

The angle is indicated by the pointer on the altitude scale of the Polar Meter. The altitude is scaled in 5 degree increments.

- 2 Attach the Polar Meter to the accessory shoe on the AP mount as shown in the figure.

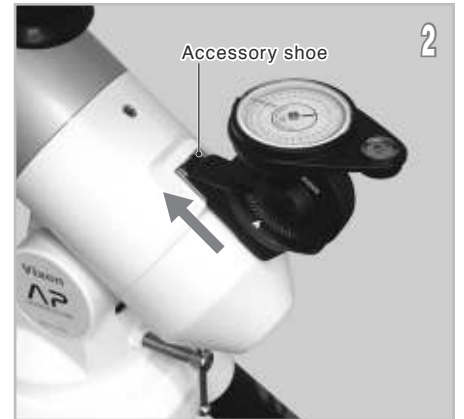

- 3 Change the direction of the AP mount so that the pointer on the compass of the Polar Meter points N sign on the dial of the compass.

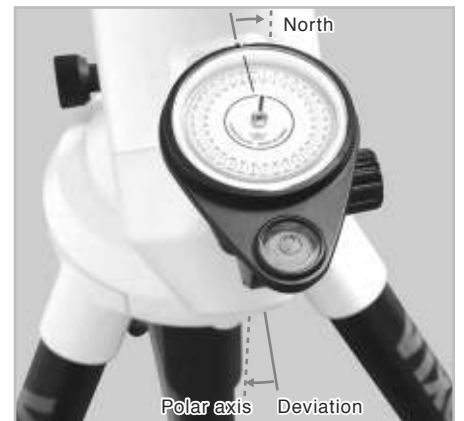

- 4 Adjust the elevation of the AP mount with the altitude adjustment bolt so that the bubble in the bubble level on the Polar Meter comes to the center of the guide circle on the level.

Next, adjust the direction with the azimuth adjustment knobs so that the pointer on the compass falls on the N on the dial of the compass.

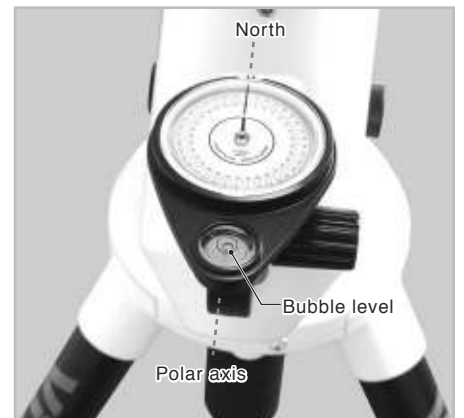
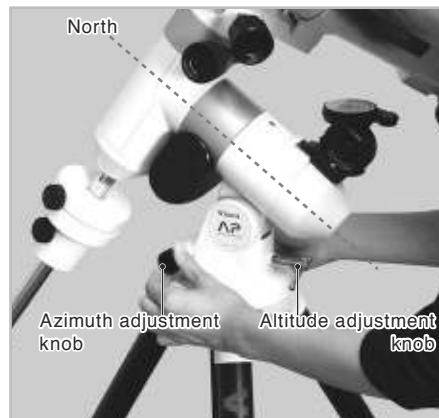

### About Magnetic Declination of Compasses

The magnetic declination is a deviation from true north or celestial north which may affect the needle of your compass. It differs depending on the area of the earth. Typically the needle of the compass points 3 to 9 degrees off to the west as you use the compass in Japan. You may obtain information on the magnetic declination of your location from the Geographical Survey Institute in your country.

Magnetic declination



Magnetic north    Celestial north

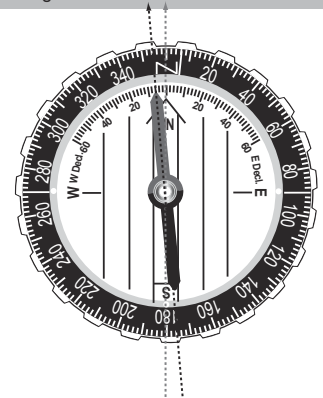

## APPLICATION

### Polar Alignment Scope

If your intention is to take long exposure astrophotography, you must accurately align the polar axis (R.A) of the mount to the celestial pole. This requires the use of a polar alignment scope sold separately. The polar alignment scope can align the polar axis of the mount as accurately as 3 arc minutes or less.

## Components guide

### Illumination ON and OFF

There is a push switch on the top of the brightness adjustment dial of the polar alignment scope. Pushing the switch will illuminate the polar alignment reticle in red light. The red light becomes dimmer gradually after a certain interval of illumination (about one or two minutes) and turns off automatically.

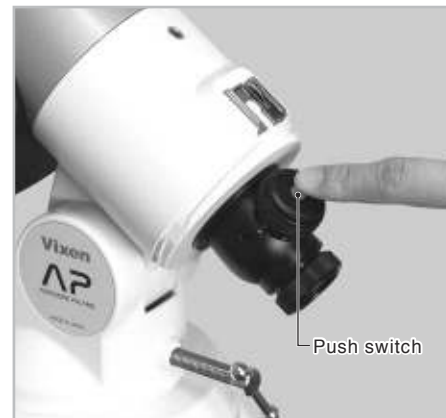

### Adjusting the Brightness

The brightness of the red light for the polar alignment reticle can be varied in 8 steps by turning the brightness adjustment dial of the polar alignment scope.



### Focusing on the Polar Alignment Reticle

You can focus on the polar alignment reticle by turning the eyepiece of the polar alignment scope. While holding the body of the polar alignment scope on one hand, turn the eyepiece part with the other hand.



# APPLICATION

## Replacing the Battery

**1** While holding the brightness adjusting dial by hand, remove the battery cover (the power switch for illuminator) on the top of the brightness adjusting dial by turning it counterclockwise.



**2** Turn the battery compartment on the polar alignment scope downward as shown in the figure so that the old battery can fall out of from the battery compartment.



**3** Turn the battery compartment upward and insert a fresh battery in the battery compartment. The bottom of the battery compartment is the plus side.



**4** Replace the battery cover in place. Be sure to check if the dark field illuminator is lit by turning on the switch.



## Reticle of the Polar Alignment Scope

Star Name	Constellation
Polaris	Little Bear
$\delta$ UMi	Little Bear
51 Cep	Cepheus
$\sigma$ Oct	Octans
$\tau$ Oct	Octans
$\chi$ Oct	Octans
$\alpha$ Eri	Eridanus

Numbers

15 the year 2015

40 the year 2040

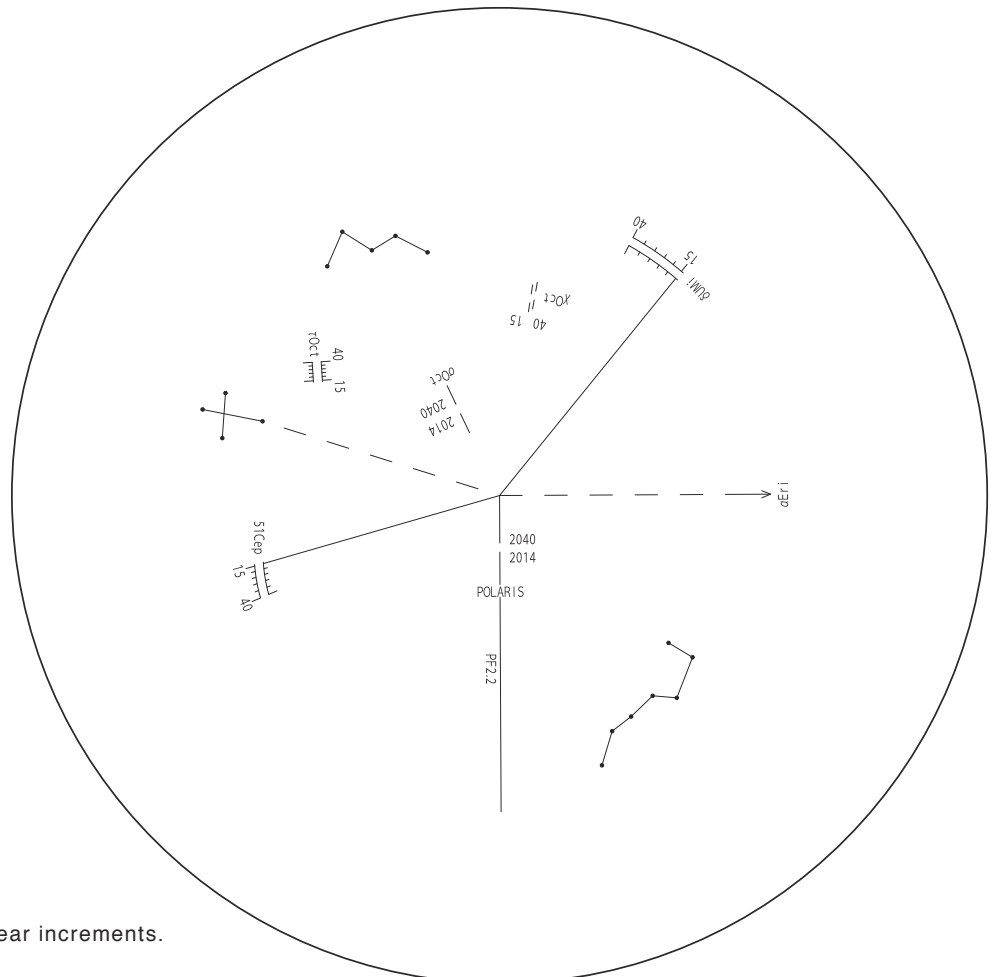

The position scales on the reticle are 5-year increments.

## APPLICATION

### Polar Alignment in the Northern Hemisphere

The polar axis of the AP equatorial mount is aligned to the North Celestial Pole in the northern hemisphere. The polar alignment scope utilizes 3 stars of Polaris, Delta UMi and 51 Cep near the North Pole. Positions of the above stars are plotted on the reticle of the polar alignment scope. To locate the N.C.P, you simply match the scale position on the reticle with the designated 3 stars seen in the polar alignment scope. Also, the patterns of the Big Dipper and Cassiopeia are engraved on the reticle for use as a guidepost for the North Pole.

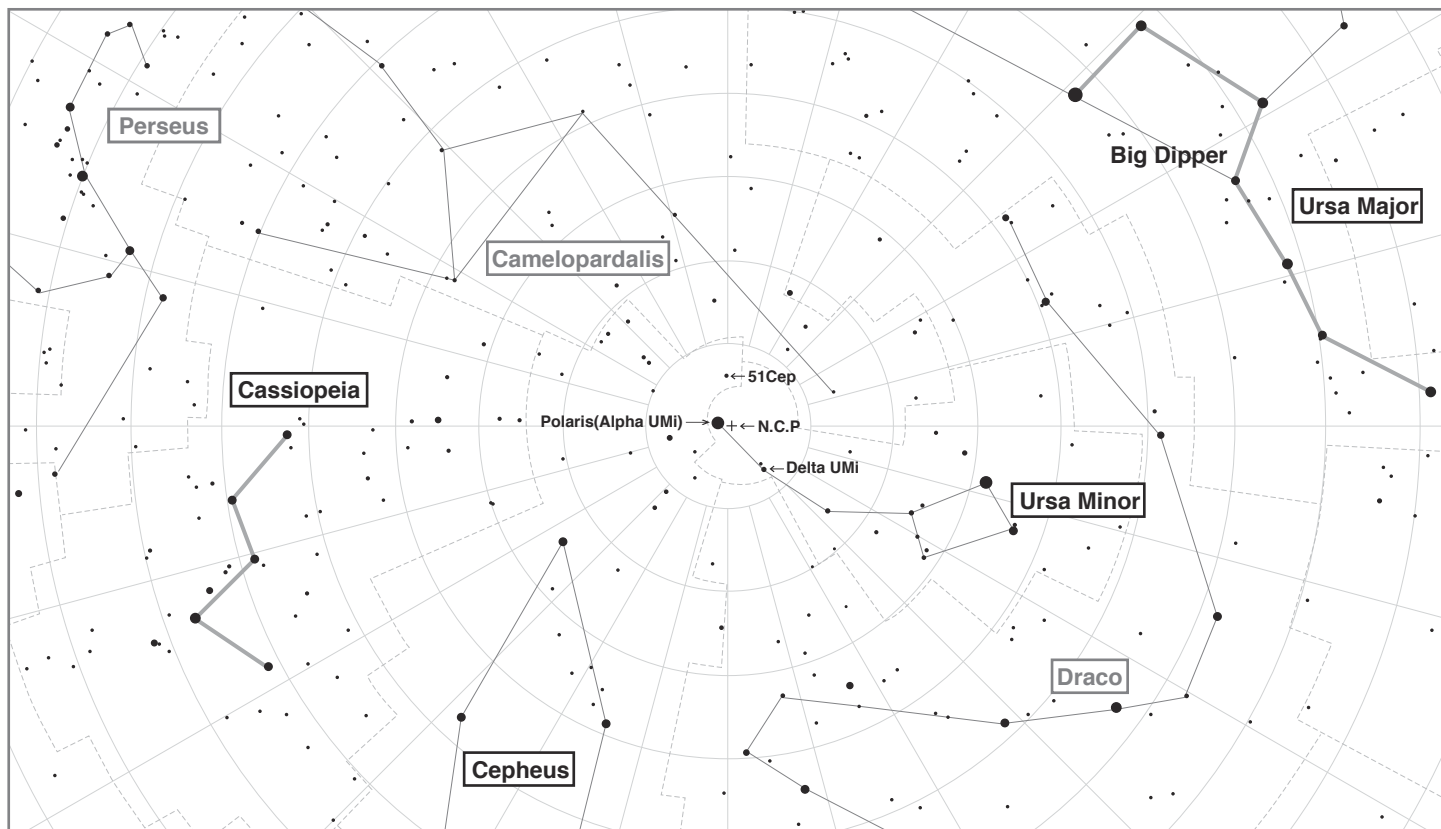

1 Check your observing site with a compass, a GPS system or a map in advance to confirm that Polaris, the Big Dipper and Cassiopeia can be seen from your observing location on the date of observation.

2 Set up the mount on flat and hard ground where you can see Polaris in the sky. Take off the polar axis cap. Point the polar axis of the mount in the direction of north as shown in the figure. Adjust the tripod legs so that the tripod is as level as possible.

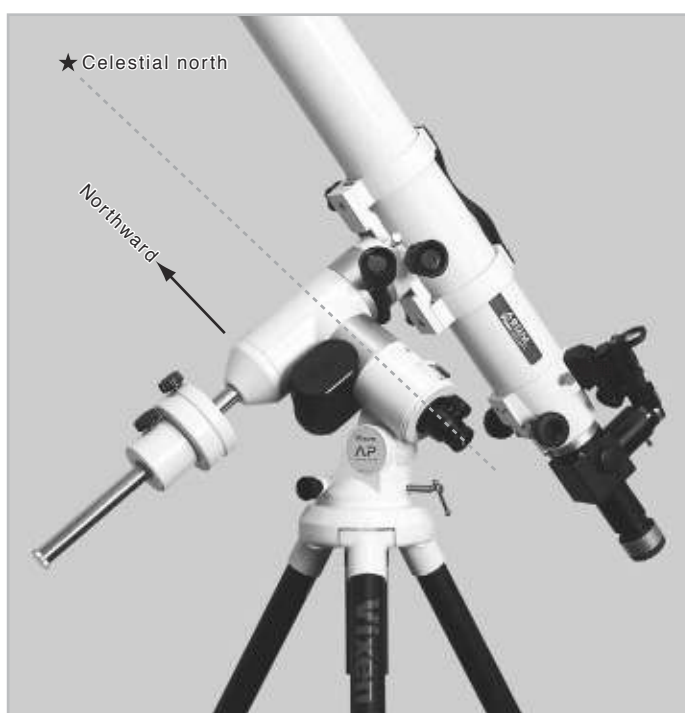

## APPLICATION

- 3 Open the round window on the declination body by sliding down the shutter of the window. While looking into the polar alignment scope, turn the polar alignment scope body so that the engraved Big Dipper (or Cassiopeia) on the reticle matches the Big Dipper (or Cassiopeia) in the real sky.

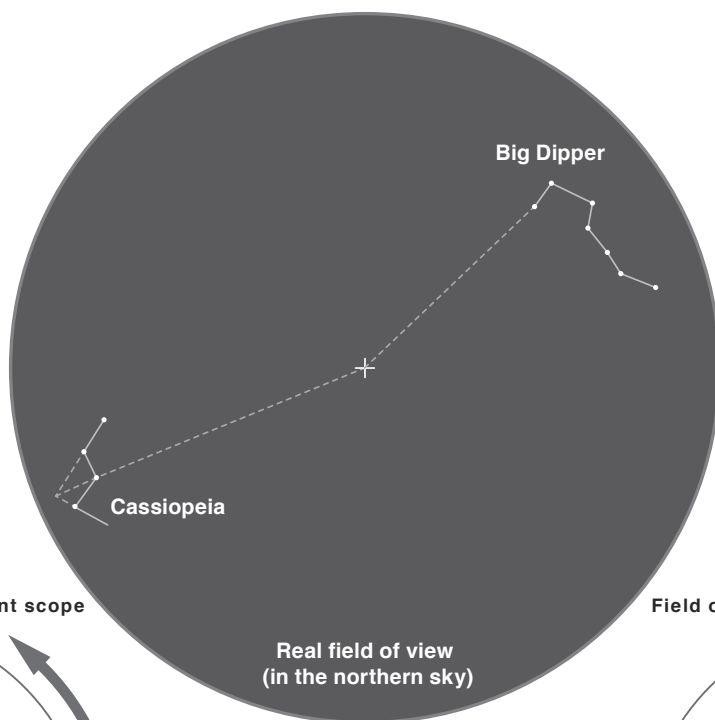
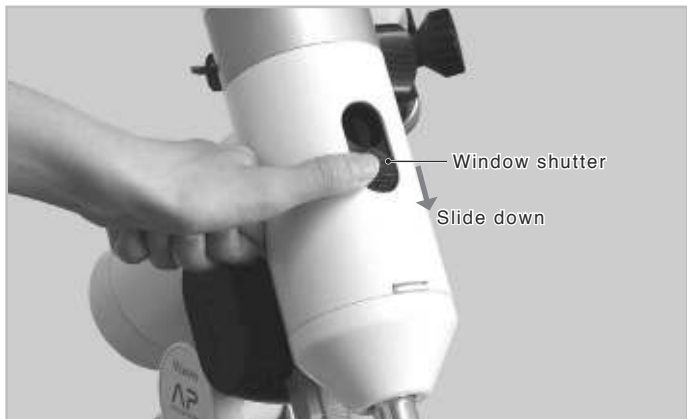

Field of view of the polar alignment scope

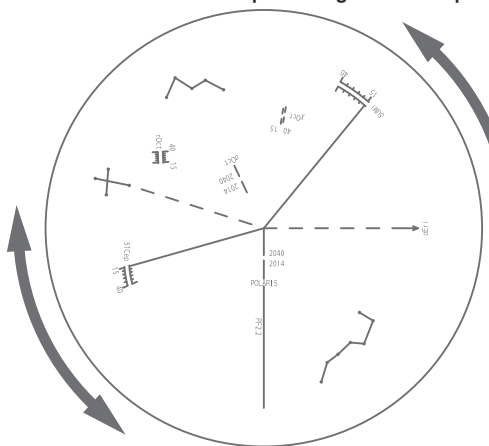

Field of view of the polar alignment scope

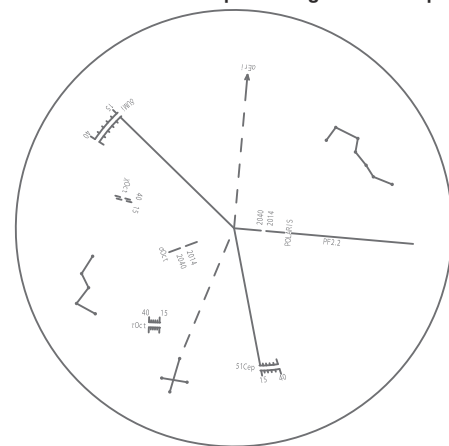

Real field of view  
(in the northern sky)

Note: The real stars of the Big Dipper (or Cassiopeia) are not visible in the field of view of the polar alignment scope.

The patterns of the Big Dipper and Cassiopeia on the reticle are positioned to correspond to the real sky. They are used as a guidepost to know the turning direction of the polar alignment scope's reticle. The locations of the Big Dipper and Cassiopeia on the reticle have no relation to the location of Polaris, Delta UMi and 51 Cep on the reticle.

## APPLICATION

- 4 While looking into the eyepiece of the polar alignment scope, adjust the direction of the mount by turning the altitude adjustment bolt and azimuth adjustment knobs so that Polaris comes as close as possible to the designated position on the reticle.

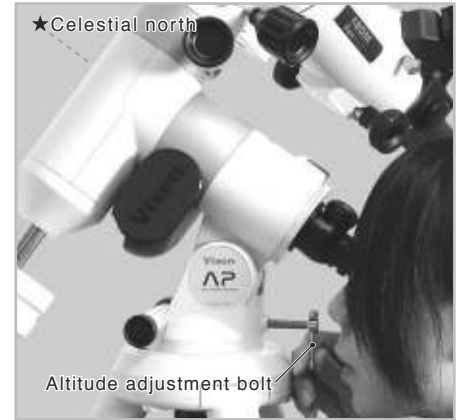

Set Polaris to the gap between the two segments of the lines marked 2014 and 2040 adjacent to a mark "POLARIS" as shown in the figure.

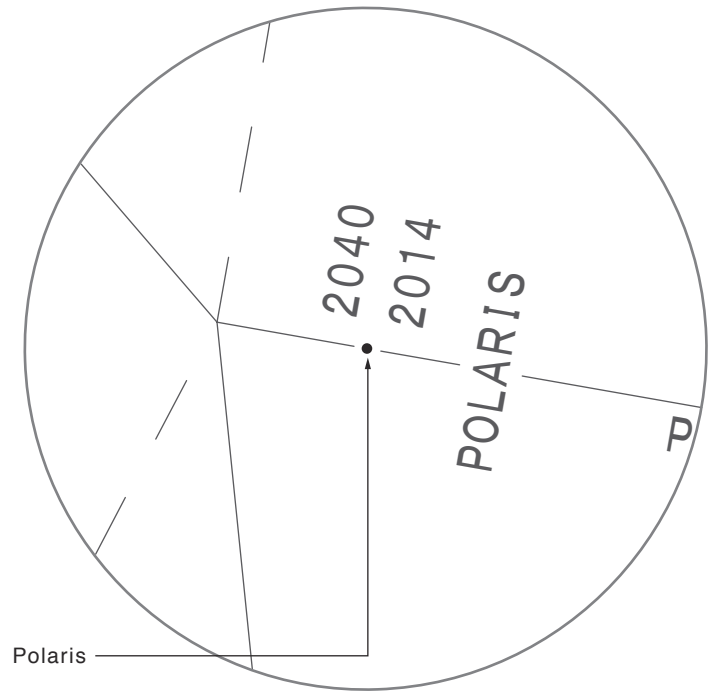

- 5 As Polaris shifts to the designated position on the reticle, both Delta UMi and 51 Cep come close to their own designated position scales respectively. While looking into the eyepiece of the polar alignment scope, turn the polar alignment scope body so that each of the position scale for Delta UMi and 51 Cep come to the closest to actual Delta UMi and 51 Cep respectively.

The numbers 15 and 40 on the position scales for Delta UMi and 51 Cep show the years 2014 and 2040 respectively.

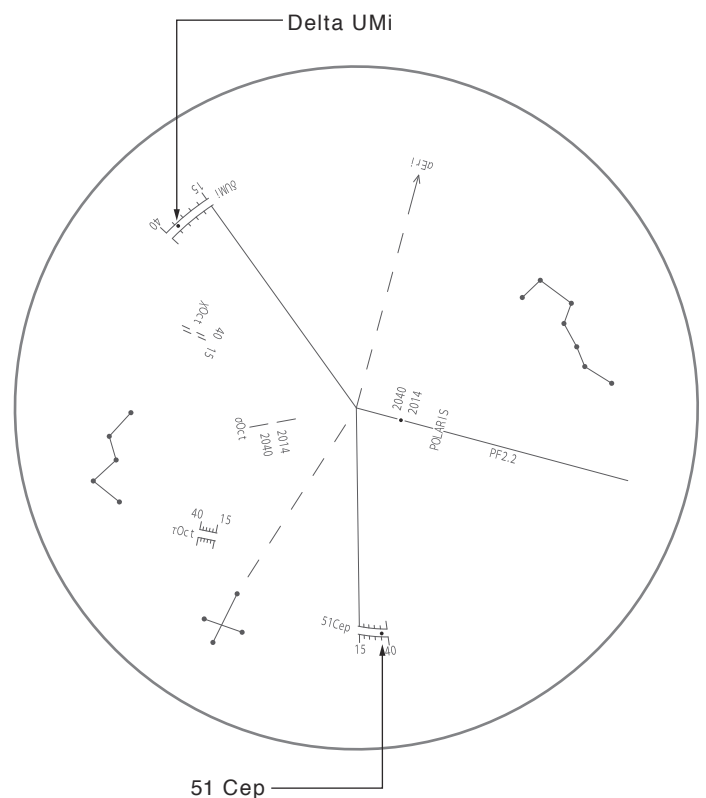

# APPLICATION

Polaris is out of place from the designated position. This is part of the process.

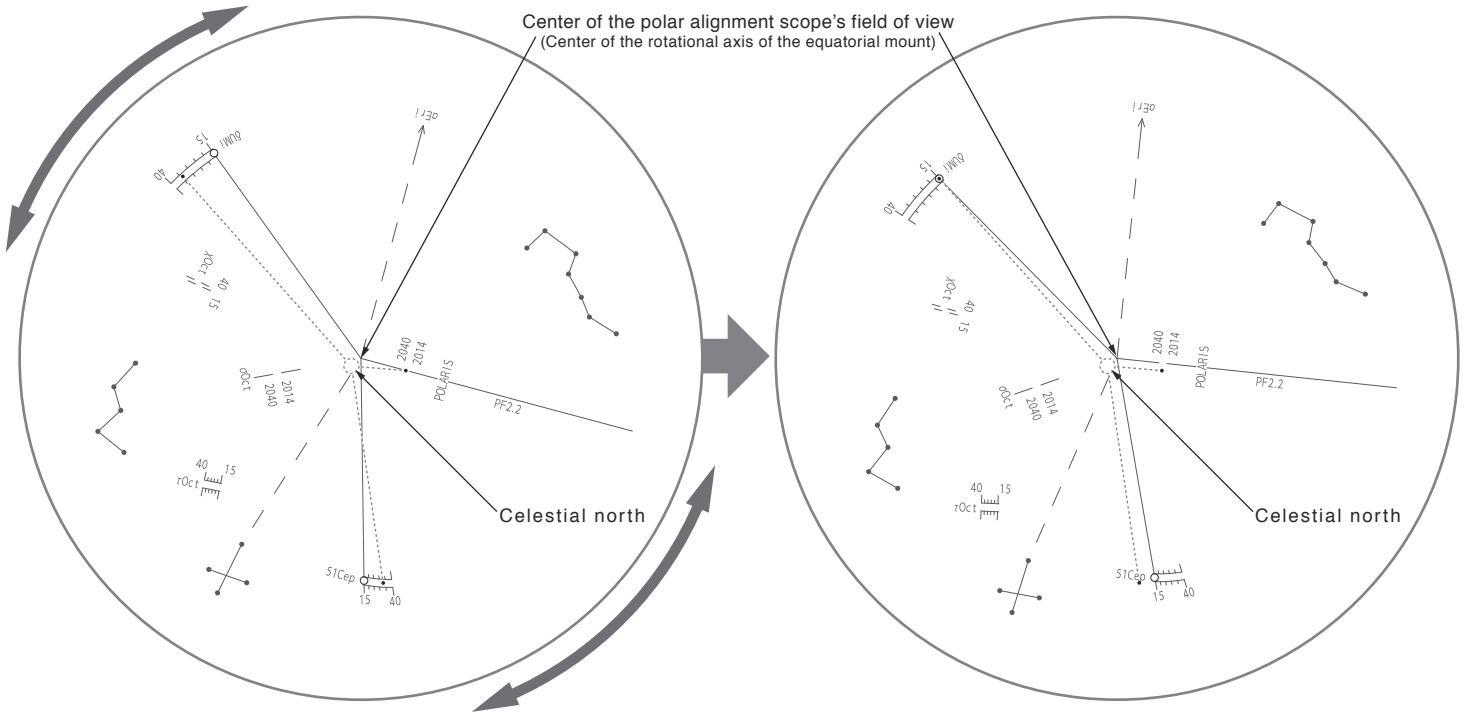

Since there is no mark that points at the North Celestial Pole, you need to match the polar axis of your AP equatorial mount with the N.C.P using the conspicuous polar star and two stars in the same area of the sky. This is called polar alignment.

As an illustration here, Polaris is set to the edge of the line on the side of 2014, and both Delta UMi and 51 Cep are to set to the middle of the curved lines of the position scale at the protruded edge on the side of 15 respectively. (In case of the year 2014)

Turn the polar alignment scope body so that Delta UMi comes near to the location of the year 2014 on the scale. And then, Polaris will get out of position from the gap between the lines.

Adjust the red light illumination to be dimmer if the reticle is too bright to see the 4th magnitude Delta UMi.

If the 5th magnitude 51 Cep is hard to see in the polar alignment scope's field of view, at least be sure to set Delta UMi to the position scale on the reticle.

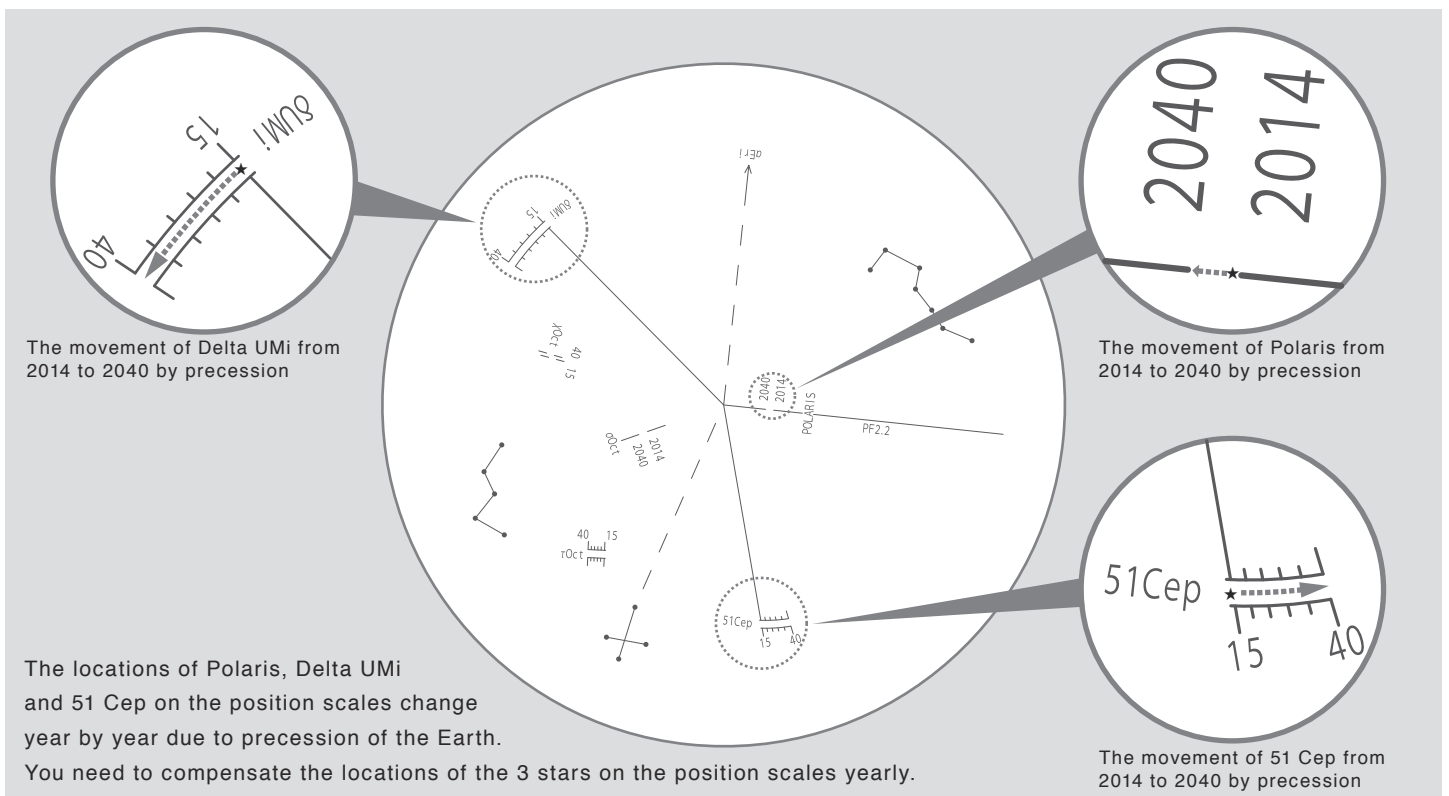

The movement of Delta UMi from 2014 to 2040 by precession

The movement of Polaris from 2014 to 2040 by precession

The locations of Polaris, Delta UMi and 51 Cep on the position scales change year by year due to precession of the Earth.

You need to compensate the locations of the 3 stars on the position scales yearly.

The movement of 51 Cep from 2014 to 2040 by precession

# APPLICATION

6 While looking into the eyepiece of the polar alignment scope, turn the altitude adjustment bolt and azimuth adjustment knobs so that Polaris comes to the gap between the two segments of the lines marked 2014 and 2040.

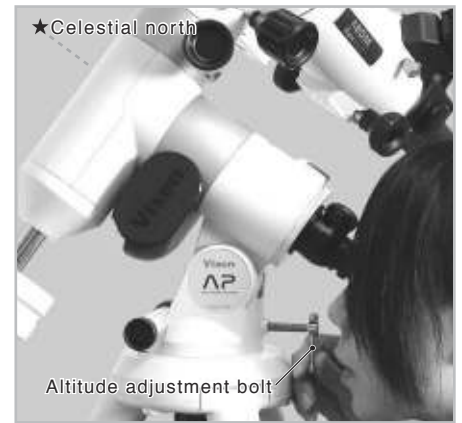

Correcting the position of Polaris with the altitude adjustment bolt and azimuth adjustment knobs

Correcting the position of Delta UMi and 51 Cep with a rotation of the polar alignment scope

Set Polaris to an approximate position that is corresponding to the year of your observation.

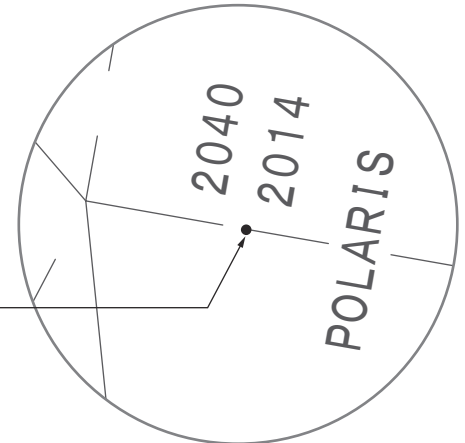

7 Repeat the procedures 5 and 6 until Polaris, Delta UMi and 51 Cep come to the proper locations on the designated position scales respectively. Tighten the azimuth adjustment knobs at both sides to finish the polar alignment.

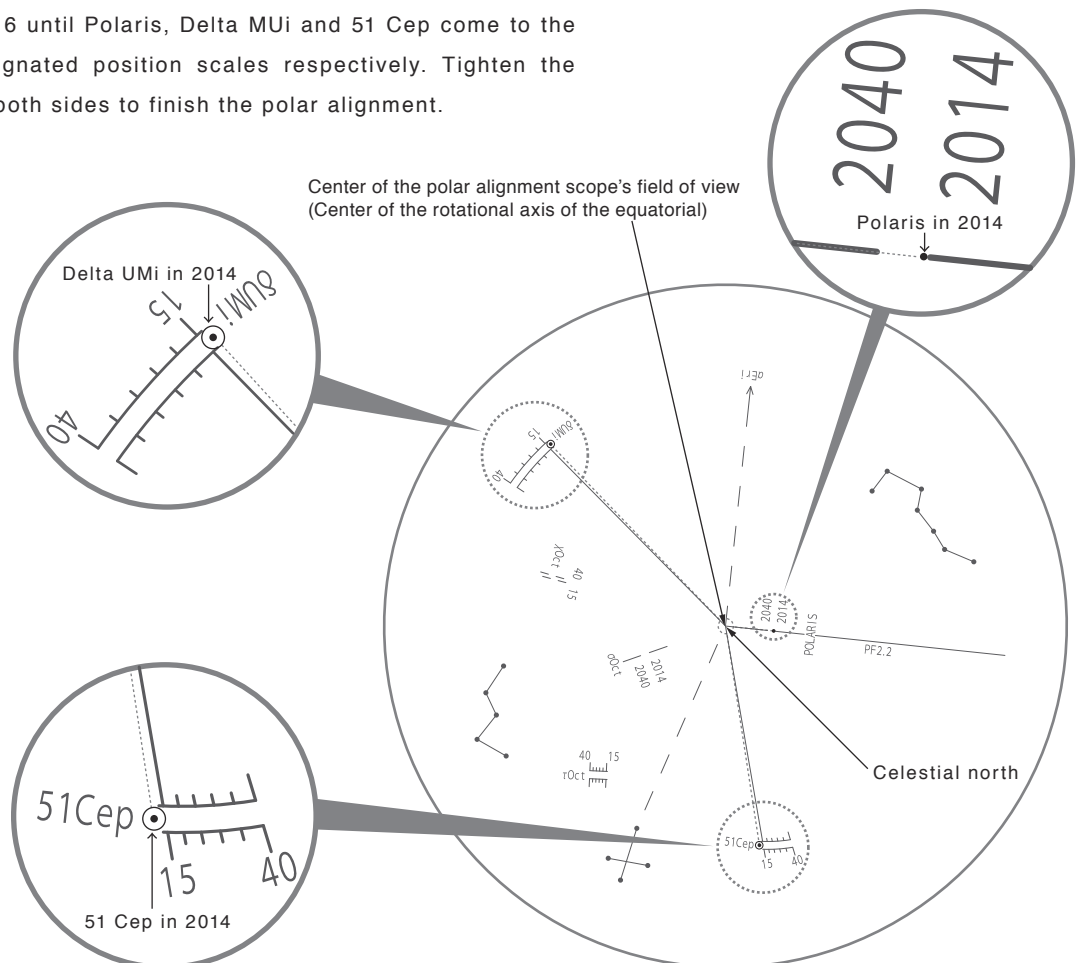

As an illustration here, Polaris is set to the edge of the line on the side of 2014, and both Delta UMi and 51 Cep are set to the middle of the curved lines of the position scale at the protruded edge on the side of 15 respectively. (In case of the year 2014)



## APPLICATION

### Polar Alignment in the Southern Hemisphere

The polar axis of the AP equatorial mount is aligned to the South Celestial Pole in the southern hemisphere. The polar alignment scope utilizes 3 stars of Sigma Octantis, Tau Octantis and Chi Octantis near the South Pole. Positions of these stars are plotted on the reticle of the polar alignment scope. To locate the S.C.P, you simply match each of the position scale on the reticle with the designated 3 stars caught by the polar alignment scope. Also, the pattern of the Southern Cross and Alpha Eridani are engraved on the reticle for use as a guidepost for the South Pole.

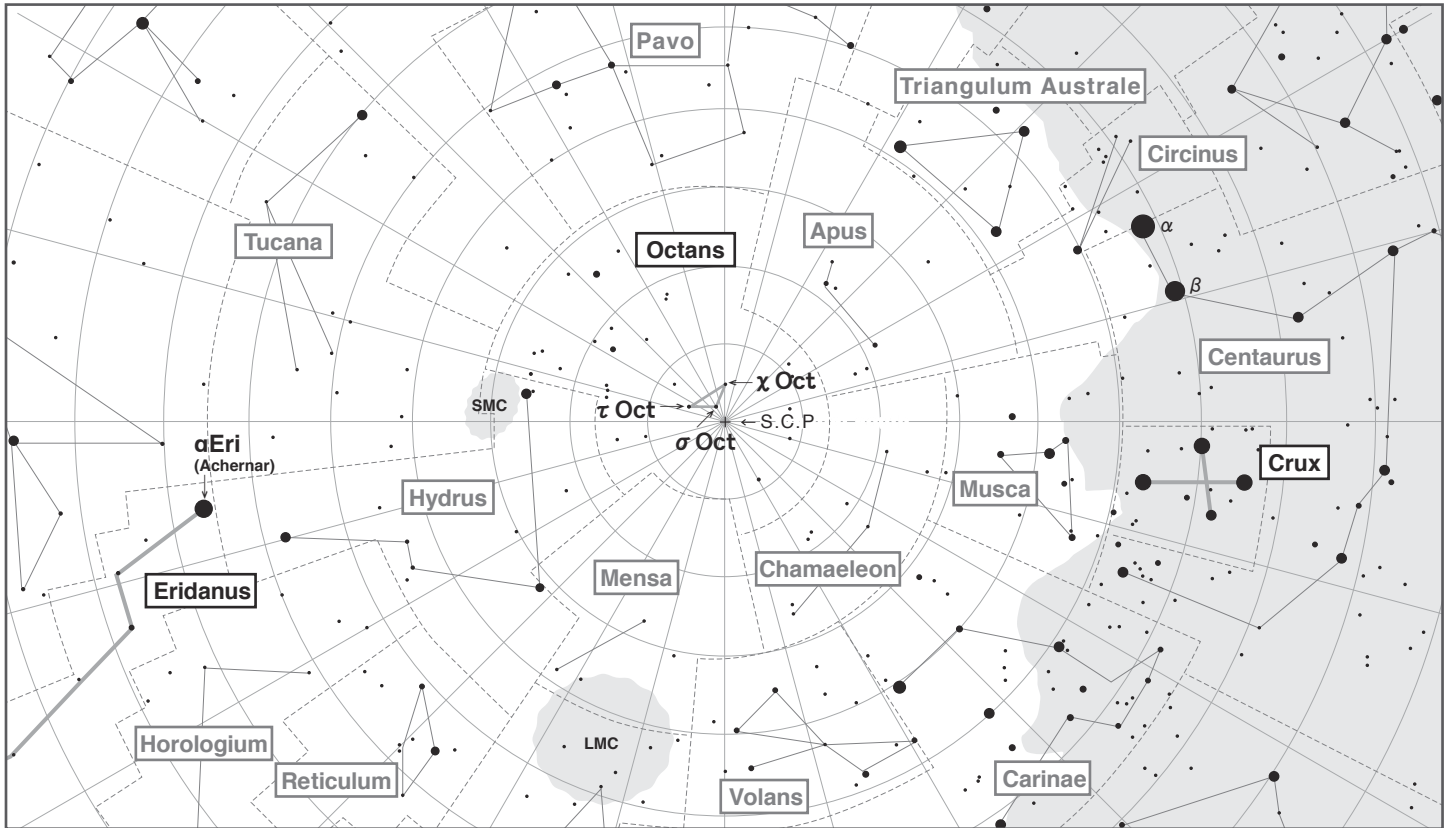

1 Check your observing site with a compass, a GPS system or a map in advance to confirm that Octans, the Southern Cross and Alpha Eridani can be seen from your observing location on the date of observation.

2 Set up the mount on flat and hard ground where you can see Octans in the sky. Take off the polar axis cap. Point the polar axis of the mount in the direction of north as shown in the figure. Adjust the tripod legs so that the tripod is as level as possible.

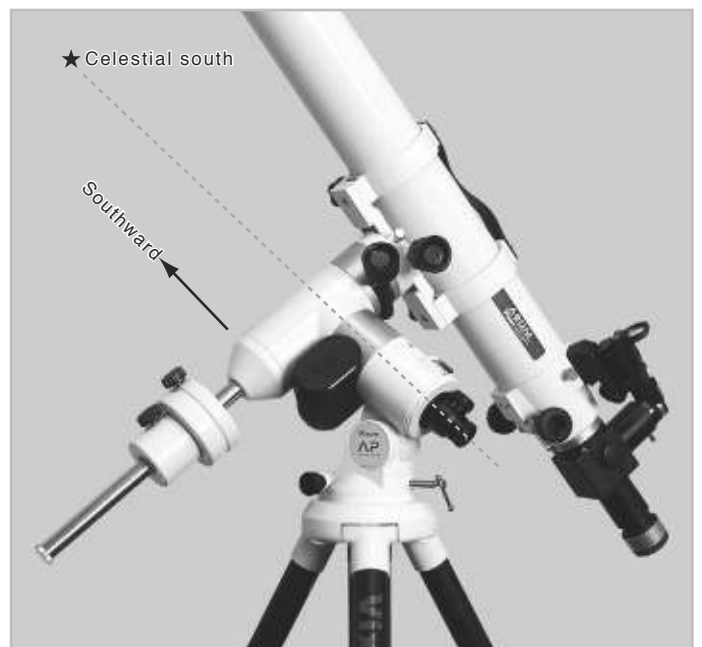
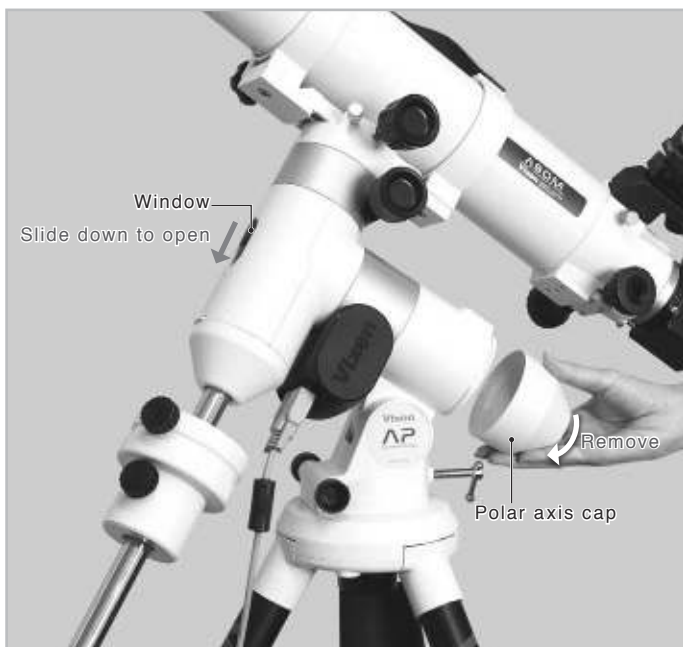

## APPLICATION

- 3 Open the round window on the declination body by sliding down the shutter of the window. While looking into the polar alignment scope, turn the polar alignment scope body so that the engraved Southern Cross (or Alpha Eridani) on the reticle directs the Southern Cross (or Alpha Eridani) in the real sky.

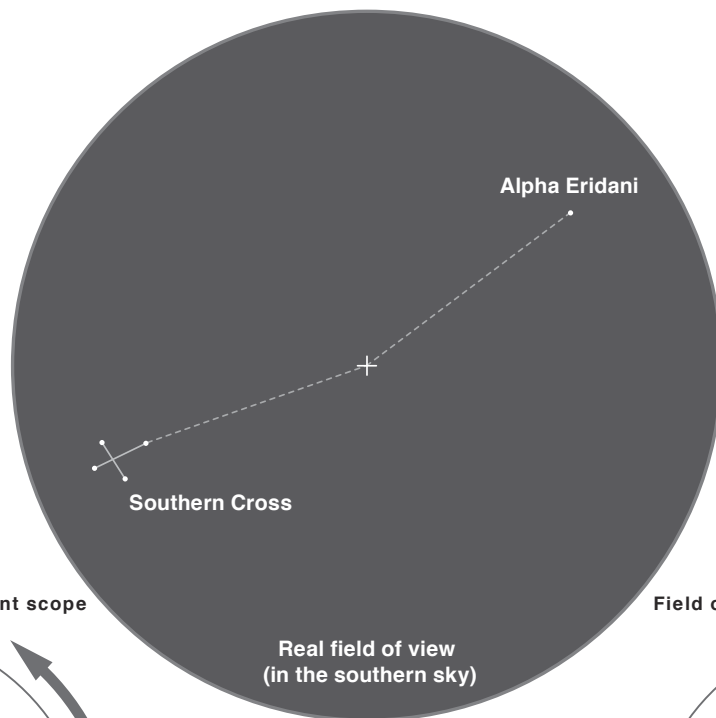
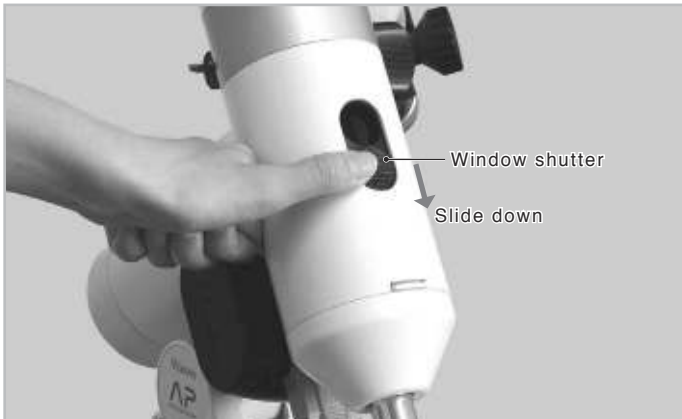

Field of view of the polar alignment scope

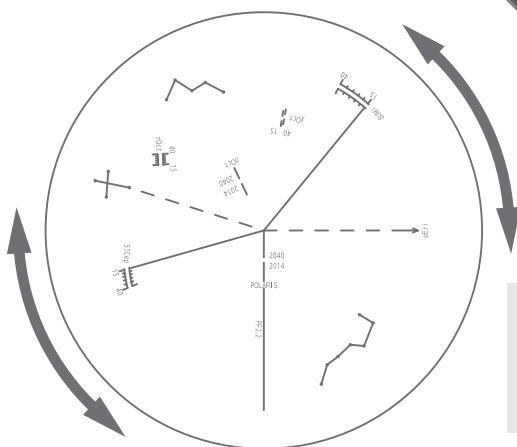

Field of view of the polar alignment scope

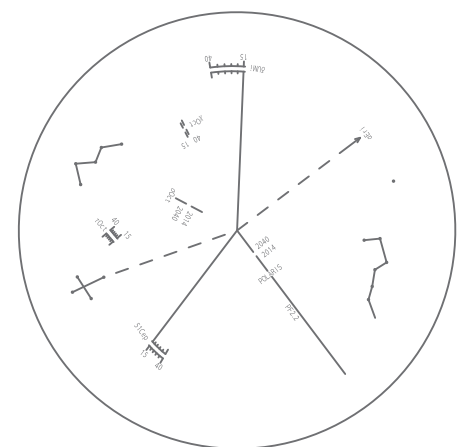

Real field of view  
(in the southern sky)

Note: The real stars of the Southern Cross (or Alpha Eridani) are not visible in the field of view of the polar alignment scope.

Both the Southern Cross and Alpha Eridani on the reticle are positioned to correspond to the real sky. They are used as a guidepost to know the turning direction of the polar alignment scope's reticle. The locations of the Southern Cross and Alpha Eridani on the reticle have no relation to the locations of the Octantis stars on the reticle.

## APPLICATION

- 4 While looking into the eyepiece of the polar alignment scope, adjust the direction of the mount by turning the altitude adjustment bolt and azimuth adjustment knobs so that Sigma Octantis comes as close as possible to the designated position on the reticle.

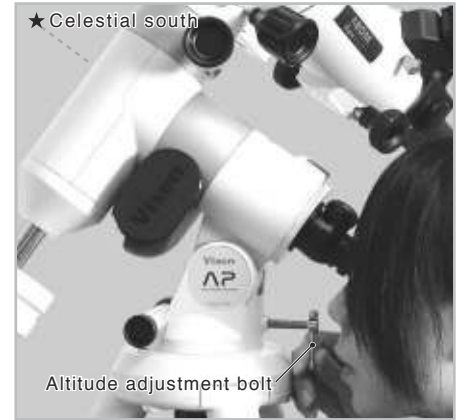

Set Sigma Octantis to the gap between the two segments of the lines marked 2014 and 2040 adjacent to a mark “ $\sigma$  Oct” as shown in the figure.

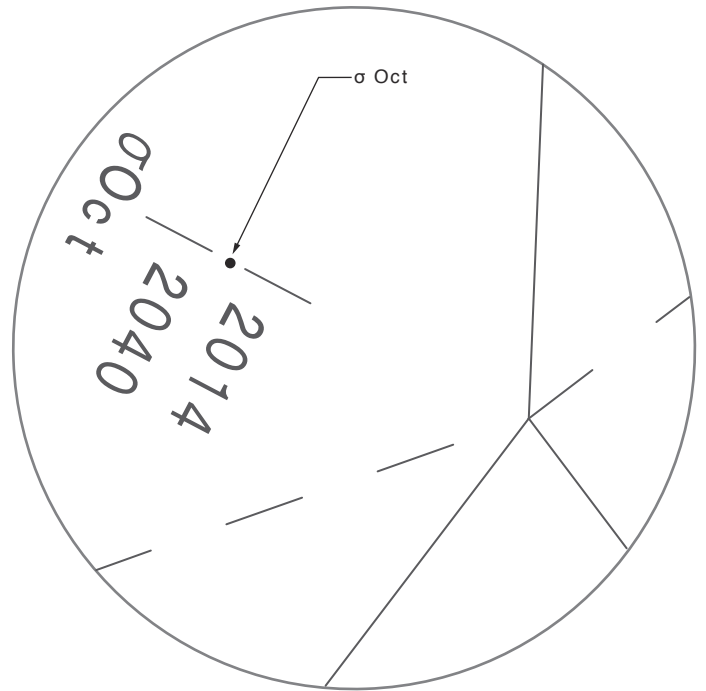

- 5 As Sigma Octantis shifts to the designated position on the reticle, both Tau Octantis and Chi Octantis come close to their own designated position scales respectively. While looking into the eyepiece of the polar alignment scope, turn the polar alignment scope body so that each of the position scale for Tau Octantis and Chi Octantis come to the closest to actual Tau Octantis and Chi Octantis respectively.

The numbers 15 and 40 on the position scales for Tau Octantis and Chi Octantis show the years 2014 and 2040 respectively.

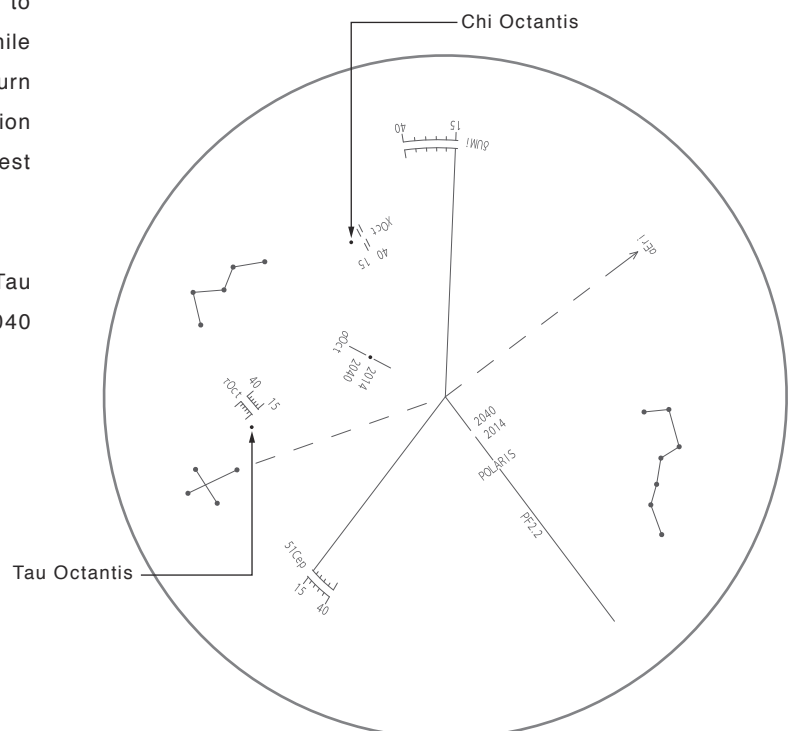

# APPLICATION

Now, Sigma Octantis gets out of place from the designated position but it is not necessary to correct for it at this stage.

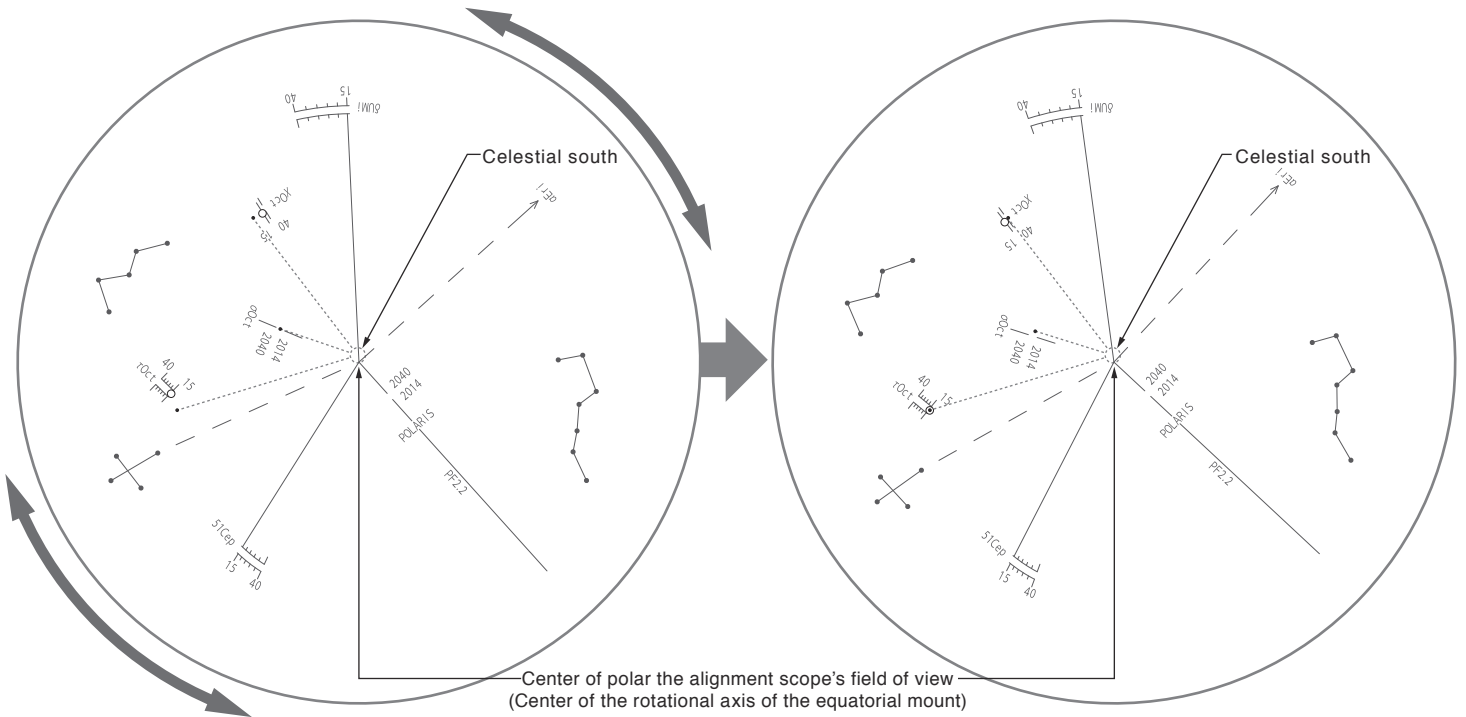

Since there is no mark that points at the South Celestial Pole, you need to match the polar axis of your AP equatorial mount with the S.C.P using the relatively dim Octantis stars in the neighborhood. This is called polar alignment.

As an illustration here, Sigma Octantis is set to the edge of the line on the side of 2014, and both Tau Octantis and Chi Octantis are to set to the middle of the curved lines of the position scale at the protruded edge on the side of 15 respectively. (In case of the year 2014)

Turn the polar alignment scope body so that Tau Octantis comes near to the location of the year 2014 on the scale. And then, Sigma Octantis will get out of position from the gap between the lines.

Adjust the red light illumination to be dimmer if the reticle is too bright to see the 5th magnitude Tau Octantis.

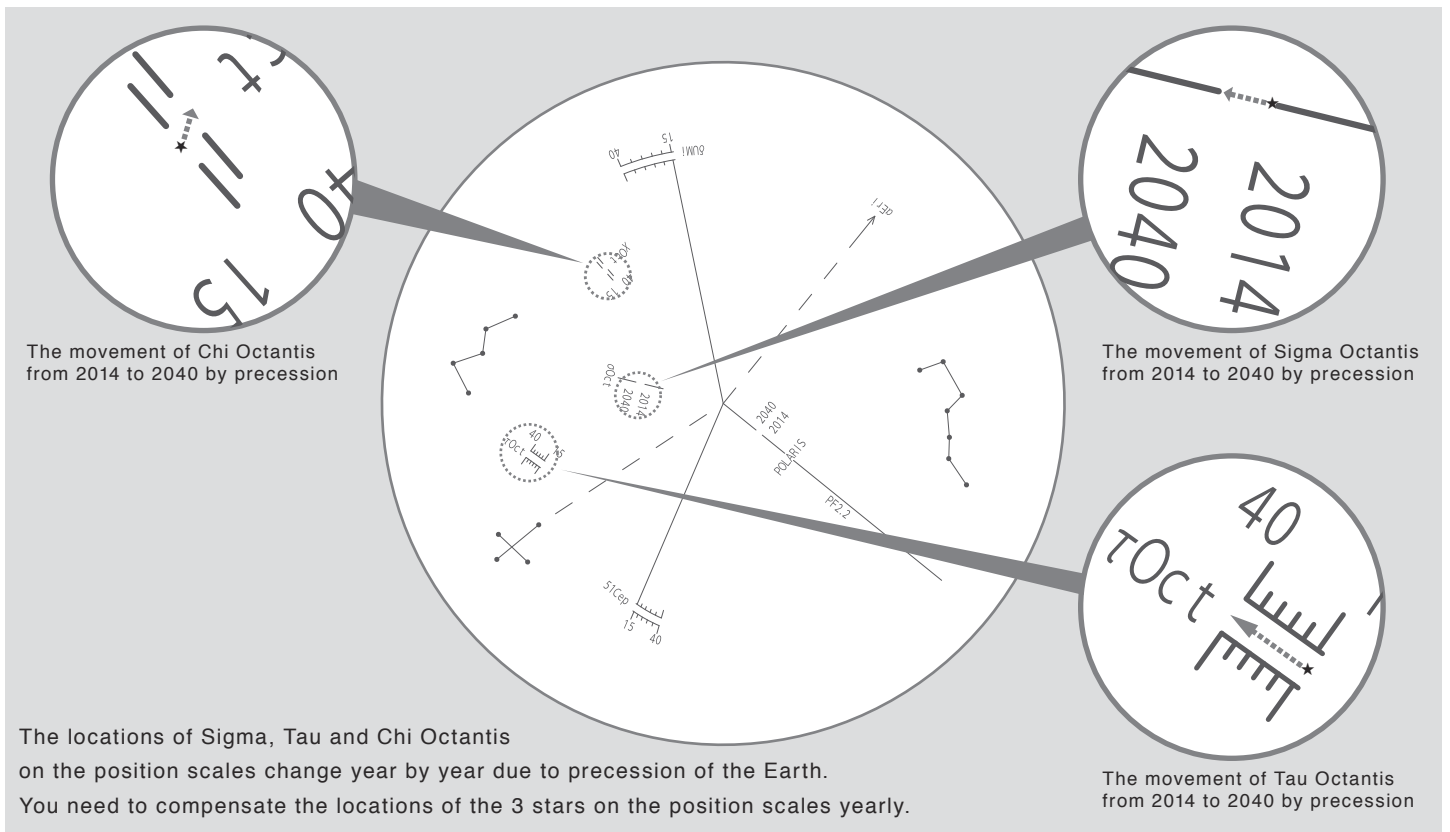

# APPLICATION

6 While looking into the eyepiece of the polar alignment scope, turn the altitude adjustment bolt and azimuth adjustment knobs so that Sigma Octantis comes to the gap between the two segments of the lines marked 2014 and 2040

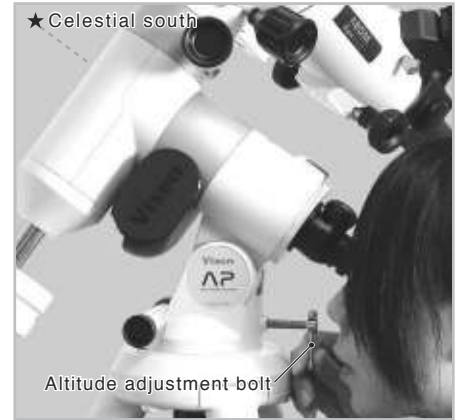

Correcting the position of Sigma Octantis with the altitude adjustment bolt and azimuth adjustment knobs

Correcting the position of Tau and Chi Octantis with a rotation of the polar alignment scope.

Set Sigma Octantis to an approximate position that is corresponding to the year of your observation.

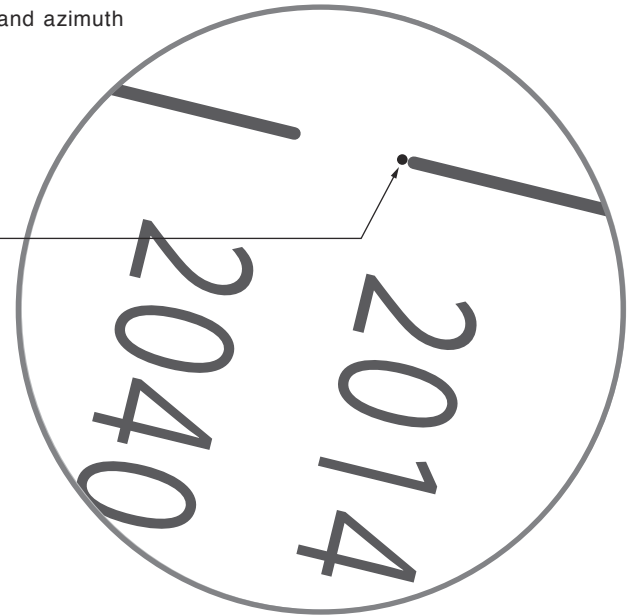

7 Repeat the procedures 5 and 6 until Sigma, Tau and Chi Octantis come to the proper locations on the designated position scales respectively. Tighten the azimuth adjustment knobs at both sides to finish the polar alignment.

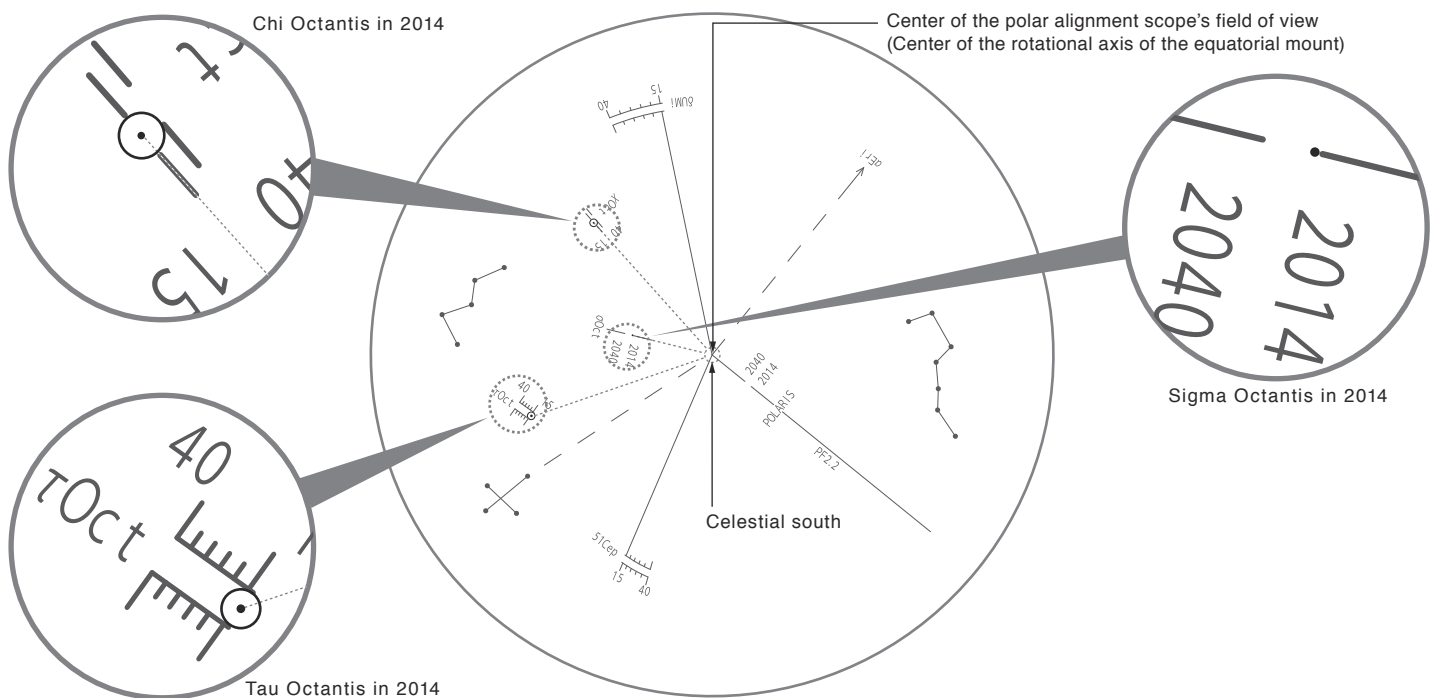

As an illustration here, Sigma Octantis is set to the edge of the line on the side of 2014, and both Tau and Chi Octantis are set to the middle of the curved lines of the position scale at the protruded edge on the side of 15 respectively. (In case of the year 2014)

## APPLICATION

### Tips on Finding Octans

The constellation Octans is made up of dark stars about 5th magnitude on average. The nearest star to the south celestial pole is Sigma Octantis, which is one of four stars forming a trapezoid in Octans, visible at 5.5th magnitude. There are a few methods to locate inconspicuous Octans using the surrounding stars.

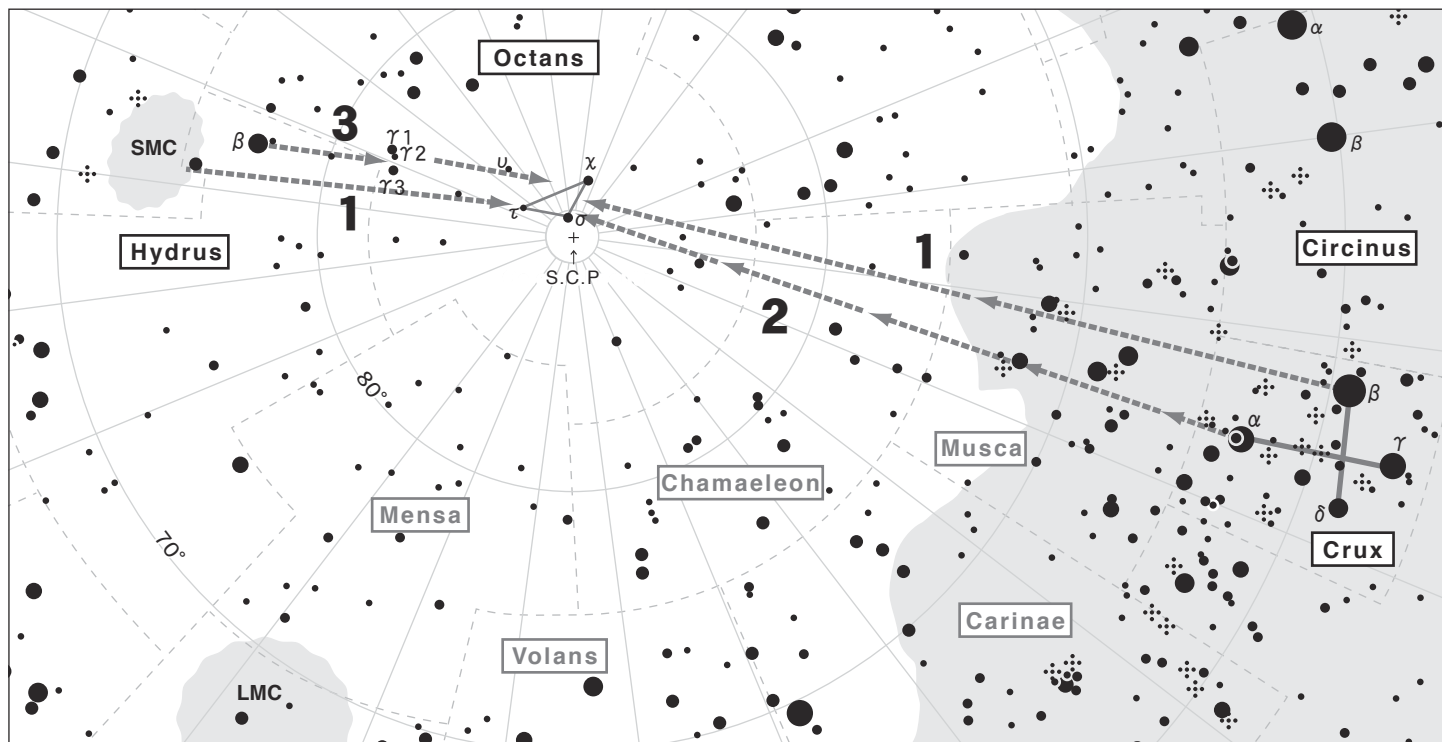

Note: The orientation of Octans changes depending on the season of year.

#### 1. Directing to Octans using Small Magellanic Cloud and the Southern Cross (Crux) as pointers

Draw an imaginary line between the center of Small Magellanic Cloud and Beta Crux, and divide it at a ratio of one to two. You will find the four stars of Octans at the divide.

#### 2. Directing to Octans using the arrangement of stars in the Southern Cross (Crux) as pointers

Draw an imaginary line straight through the two stars (Alpha and Beta Crux) of the Southern Cross making the vertical line of the cross toward Small Magellanic Cloud. You will find the four stars of Octans at a place about 4.5 times extended from the span of the two stars.

#### 3. Directing to Octans using Small Magellanic Cloud, Beta Hydrus and Gamma Octantis as pointers

If you cast your eyes toward Crux from Small Magellanic Cloud, you will see Beta Hydrus. Going southward from Beta Hydrus will find you Gamma Octantis which consists of a row of three stars. Continue on your eyes by the same distance toward the Southern Cross and you will find the four stars of Octans.

## APPLICATION

### Change Settings on the Mount / Controller

STAR BOOK ONE controller menus allow you to change your desired settings on the mount (and controller)

#### Mount Menu

Pressing the MOUNT button will turn up the brightness of the button itself and allow you to access various Mount menus using the direction keys. At the same time, it disables the direction keys for slewing the mount except adjustments in the duration of a PEC recording. Press the MOUNT button again to return to slewing with the direction keys. The brightness of the MOUNT button dims. The new settings are saved to the flash memory.

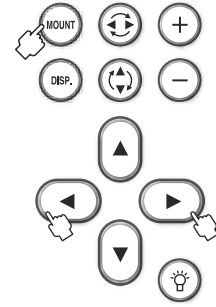

#### Your settings are not saved in the following instances:

- \* Turned off the power without completing saving.
- \* Recorded PEC data are not saved if you shut off the power.

#### Tracking Speed

This allows for changing the tracking speed. The setting is defaulted to "Star".

#### Procedure:

Pressing the MOUNT button will turn up the brightness of the MOUNT button and enables you to access subsidiary menus. The subsidiary menu appears as you press the left or right direction key each time. Display the "TrackSpd" to choose the tracking speed setting.



Press the up or down direction key to choose your desired tracking speed other than the sidereal rate ("Star"). The new tracking speed is saved as indicated.

The following tracking speeds are available.

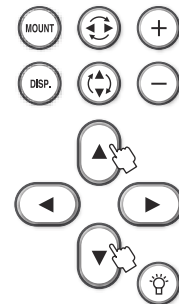

Sidereal rate:

TrackSpd  
Star

Kings rate (mean sidereal time):

Atmospheric refraction is compensated in the Kings rate.

TrackSpd  
Kings

Lunar rate (mean lunar time):

TrackSpd  
Lunar

Solar rate (mean solar time):

TrackSpd  
Solar

Faster tracking speed:

TrackSpd  
Starx1.0

The faster tracking speed is divided into three ranges from low to high speed. Choose your desired speed using the plus or minus buttons. The setting is defaulted to "X1.0".

Available tracking speed ranges:

From X0.1 to X2.0 at 0.1 increment

From X2.0 to X5.0 at 0.5 increments

From X5 to X10 at 1 increment

Terrestrial Viewing:

Choose "TrackSpd Stop" with the up or down key with will halt the tracking motion.

TrackSpd  
Stop

# APPLICATION

## Tracking Direction

The slewing direction of a telescope differs in the northern and southern hemispheres. This allows for changing the rotation of the motors to slew the telescope correctly in your observing site. The setting is defaulted to the motion in the northern hemisphere "TrackDir N Hemis".

### Procedure:

Pressing the MOUNT button will turn up the brightness of the button and enables you to choose subsidiary menus. The subsidiary menu appears as you press the left or right direction key each time. Display the "TrackDir N Hemis" to choose the tracking direction setting.

For the use of the AP mount in the southern hemisphere, you need to revise the rotation of the motor. Display the "TrackDir S Hemis" with the up or down direction key to choose.

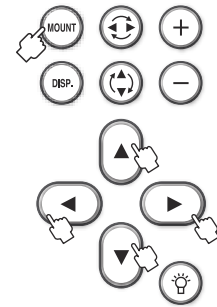

Setting in the northern hemisphere:



Setting in the southern hemisphere:



## Slewing Speed

Change the slewing speed using the plus or minus button. The slewing speed can be chosen from either a preset 4 speed range or different speed ranges from the listed slewing speeds. The setting is defaulted to "Slew 4-Speed".

### Procedure:

Pressing the MOUNT button will turn up the brightness of the button itself and enables you to choose subsidiary menus. The subsidiary menu appears as you press the left or right direction key each time. Display the "Slew 4-Speed" to choose the slewing speed setting.

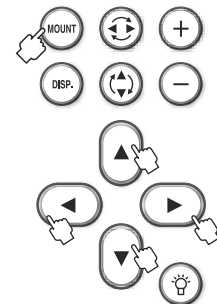

The slewing speed can be chosen between the preset "Slew 4-Speed" and versatile "Slew VariSpd" each time you press the up or down direction key (or the plus or minus button). The new slewing speed is saved as indicated.

Slewing at four defined speeds:



X0.5, X1.0, X30 and X60 of sidereal rate

Slewing at your desired speed variation from the following ranges:



X0.5 to X2.0	at 0.1 increments
X2.0 to X5.0	at 0.5 increments
X5.0 to X10	at 1 increment
X10 to X30	at 5 increments
X30 to X60	at 10 increments



# APPLICATION

## Backlash Compensation

Backlash is a momentary stoppage of the tracking motion of the mount that occurs when the motor gears reverse their rotation. Backlash does not occur while the mount continues tracking at a constant speed as the gears keep contact with each other, however, it may occur when the telescope is slewed with different speeds.

Backlash compensation provides a reduced time lag at the point of reversed motion where the gears lose contact. This provides smoother rotation of the gears on the mount.

Too much tight engagement of the gears will halt the rotation. Make sure that there is slight play.

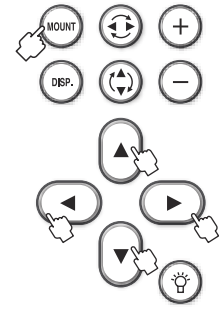

### Note:

\* Backlash compensation is not compatible with an autoguider in most cases. Cancel using this option when you use an autoguider.

### First, Checking the Backlash

It is best to use a bright 1st magnitude star in order to check backlash amount for compensation.

### Procedure:

1 Precisely polar align the mount.

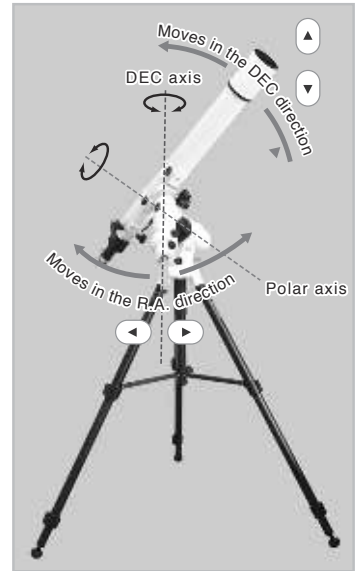

2 Center a bright 1st or 2nd magnitude star in the field of view of your eyepiece.

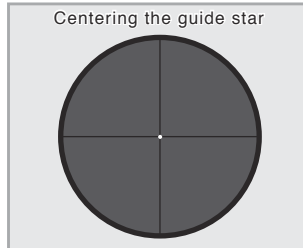

3 Press the Mount button and Call up "Slewing Speed" in the Mount menu to choose the "Slew VariSpd".



4 Press the Mount button to make the direction keys available. Set the slewing speed between X1.2 and X4.0 with plus or minus button.



5 Pressing the Mount button will turn up the brightness of the button and enables you to choose subsidiary menus. The subsidiary menu appears as you press the left or right direction key each time. Display the "Backlash X or Y" (X = RA and Y = DEC)" with the left or right direction key. The setting is done individually. The settings for backlash compensation are defaulted to "X: 0, Y: 0". This manual describes the setting of RA first, but you can start from either direction, RA or DEC.



Pressing the up or down key will increase or decrease the value by 10 increments and pressing the plus or minus button will increase or decrease by one increment. The values for backlash compensation are available between 0 and 99 both in RA and DEC.



## APPLICATION

- 6 Press the Mount button to make the direction keys available.  
Confirm the amount of backlash in the direction of RA.

Center the star in the field of view of your eyepiece and watch how the star moves while pressing the left direction key. Keep pressing the direction key until the star begins to move.

Next, press the right direction key to watch how the star moves in the field of view.

If there is a time lag and the star does not begin to move instantly toward the direction you press, a value for backlash compensation is set too small (weak) or set to "0".

On the contrary, if the star begins to move quickly and largely at the same time you press, a value for backlash compensation is set too big (strong).

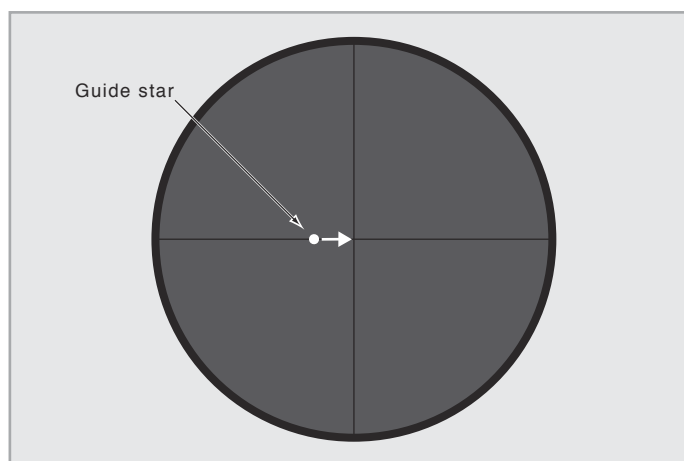

- 7 Confirm the amount of backlash in the direction of DEC in the same way using the left and right keys.

### Tips on Backlash Compensation Setting

Watch how the telescope moves when you increase the value. Start with setting an initial reference value (10 for example), and double this value after checking the telescope movement with the initial value. If the second value (= 20) is too small to compensate for the backlash, enter the number doubled (= 40) as the second value. Likewise increase the number by doubling the value if necessary.

Example: Enter 20 for the backlash compensation.

If this value is too small for the compensation, increase the value to 40. If it generates too much compensation as a result, decrease to the value halfway between 20 and 40. If the value of 30 is still somewhat bigger for the compensation, decrease to 25. On the contrary, if 30 is somewhat small, increase to 35. In this way you can adjust the mount for the most effective backlash compensation.

Backlash compensation is not compatible with an autoguider in most cases. Set the values to "0" in RA and DEC when you use the autoguider.

# APPLICATION

## Setting for Autoguider

The STAR BOOK ONE can be used for auto guiding in conjunction with an external autoguiding system that is compatible with the SBIG autoguider. Available setting rates for compensating guide errors are described here.

Auto guiding allows you to automatically guide a telescope on an equatorial mount by means of an autoguider, which translates signals from a CCD video camera attached on a guide scope, to achieve uniform and precise tracking speed of the mount. The advantages of the autoguider are most apparent during long exposure astrophotography.

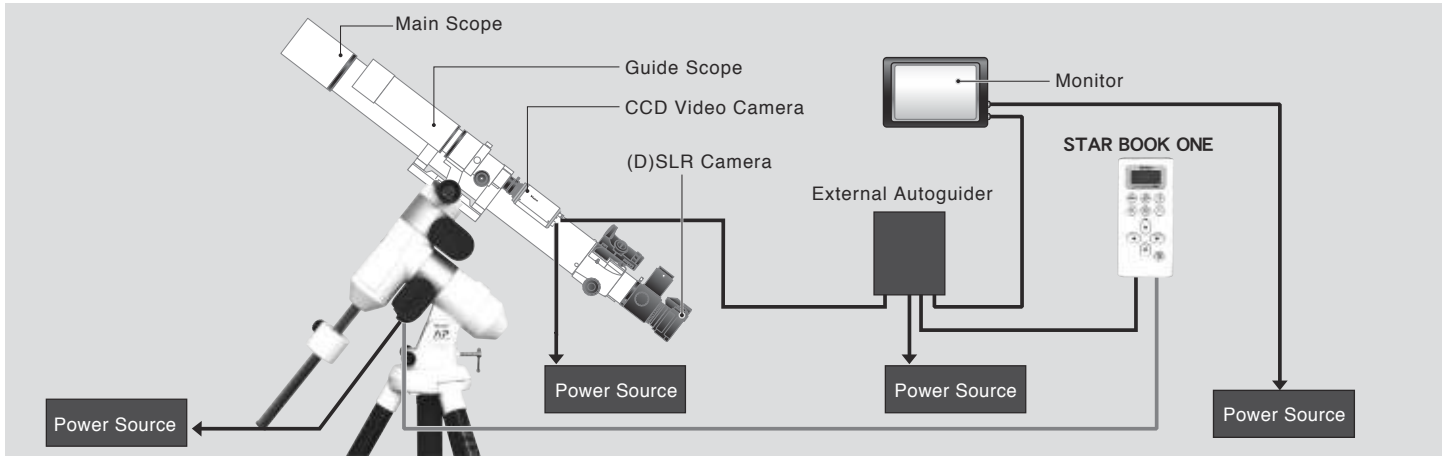

### Procedure:

1 Pressing the Mount button will turn up the brightness of the button and enables you to choose subsidiary menus. The subsidiary menu appears as you press the left or right direction key each time. Display the "A. Guide X or Y" (X = RA and Y = DEC) with the left or right direction key. The setting is done individually. The settings for autoguider are defaulted to "X: 10, Y: 10". This manual describes the setting of RA first, but you can start from either direction, RA or DEC.

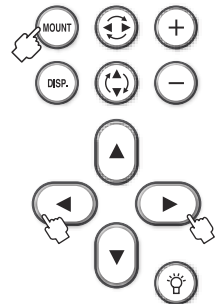
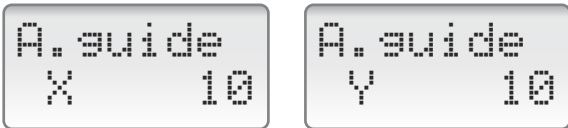

2 Pressing the up or down key will increase or decrease the value by 10 increments and pressing the plus or minus button will increase or decrease by one increment. The values for the autoguider are available between 0 and 99 both in RA and DEC. The new values are saved as indicated.

It is not recommended for use with backlash compensation. It may cause interference within tracking.

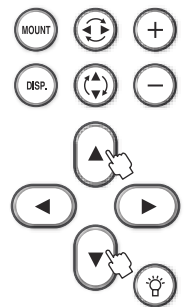

### Setting Rates for Compensation

The value of the compensation can be set between 0 and 99 in one increment both in RA and DEC (0.1X of sidereal rate). Enter a smaller value if you move slower to make small compensation, or enter a larger value if you move faster to make a large compensation.

<b>0 : Keep sidereal rate (No compensation is made.)</b>
<b>1 : ±0.1X of sidereal rate</b>
<b>2 : ±0.2X of sidereal rate</b>
<b>3: ±0.3X of sidereal rate</b>
2 2 2 2 2
<b>99: ±9.9X of sidereal rate</b>

The optimum value for the compensation may vary according to equipment used. Choose the most effective rate to make your autoguiding smoothest.

The direction keys are available to move the mount while this position is used.

If autoguiding signals are detected, the direction key corresponding to the input signal will light to indicate the status of the operation visually.

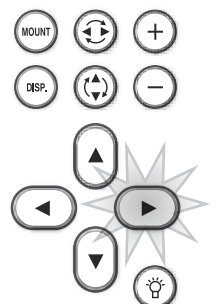

## APPLICATION

### PEC (Periodic Error Correction)

Equatorial mounts with drive motors are designed to precisely track the motion of celestial objects. With the use of a telescope mounted on the equatorial mount, you may notice that stars in the field of view of the telescope at high magnification are drifting back and forth very slowly over a period of time (e.g. 600 seconds with the AP mount) in the direction of R.A. This is caused by the motion of the tracking gear wheels and it is part of the design of equatorial mounts. The PEC (periodic error correction) rectifies this phenomenon on the equatorial mount and records the correction electronically.

The tracking accuracy varies in irregular motion and must be corrected as precisely as possible.

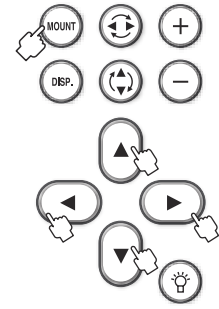

#### Starting the PEC Recording

1 Precisely polar align the mount.

2 Prepare an eyepiece with crosshairs. Center a moderate star in the field of view of the eyepiece. Put high magnification as high as 200X and more.

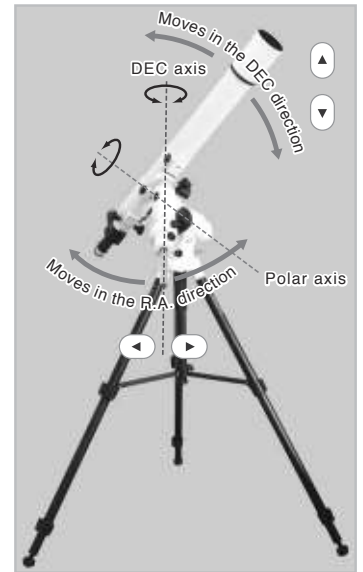
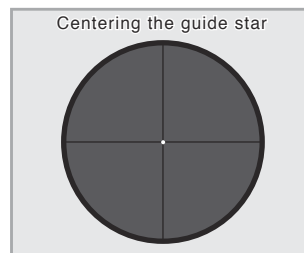

3 Pressing the Mount button will turn up the brightness of the button and it enables you to choose subsidiary menus. The subsidiary menu appears as you press the left or right direction key each time. Display the "PEC No Data" with the left or right direction key.

4 Pressing the up or down key will advance the display to "PEC StrtRec?" and the plus and minus buttons will blink.

5 Press the + button to start a PEC recording. The period of time for the PEC recording is 10 minutes (600 seconds). On starting the PEC recording, the counter starts from 600 (599) and counts down every second to 0 and repeats. The speed of correction with the left or right direction key is fixed at 0.5 times of sidereal rate. To cancel the menu, press the minus button.

6 As you monitor the star in the field of view, it begins to shift away from the center of the crosshairs in direction of the RA tracking. At the point in time where the deviation is apparent, bring the star back to the center of the crosshairs with the left or right direction key for correction.

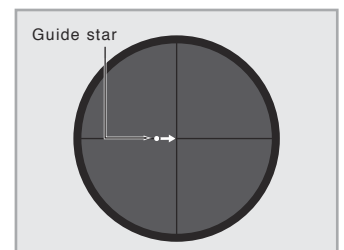

7 A cycle of the PEC recording ends as the 600 seconds has elapsed, but the duration of the recording continues until you stop it. The old recording data is overridden by new ones.

Note: Be sure to continue more than 10 minutes to make sure to complete one cycle of the PEC recording.

## APPLICATION

### Stopping the PEC Recording

- 1 Press the MOUNT or DISPLAY button to stop the PEC recording. The dialogue "PEC StopRec" appears on the display and press the + button to stop. Pressing the minus button will cancel the dialogue and continue the PEC recording.



- 2 If the PEC recording is stopped, only the ongoing record of the current cycle is cleared.

If the PEC recording goes more than one cycle before you stop, playback will start at the same time you stop it and the numbers will be counted down every second.

- 3 If you adjust the mount with the direction keys while the PEC recording is played back, press the MOUNT button. The countdown remains displayed as it is.

- 4 If less than one cycle is recorded before you stop, the PEC recording is cleared and not saved for play back.



### Resuming in the Playback Status

Resuming the PEC recording or stopping the playback.

- 1 Display "PEC ●●● Play" during the playback status of the PEC (The MOUNT button is turned up.). ●●● are arbitrary numbers.



- 2 The "PEC StopPly?" or "PEC StrtRec?" appears in the menu alternately as you press the up (or down) direction key each time.

Choose "PEC StrtRec?" and press the + button to resume the recording of the PEC. To stop the PEC playback, choose "StopPly?" and press the + button.



To cancel the menu, press the minus button.

### Resuming in the Stop Status

Resume the playing back/deleting/recording/of the PEC.

- 1 Display "PEC StopPlay?" during the stop status of the PEC (The MOUNT button is turned up.).



- 2 The "PEC StrtPlay?" or "PEC StrtRec?" or "PEC Delete?" appears in a cycle in the menu as you press the up (or minus) direction key each time.

3. Choose "PEC StrtPlay?" and press the + button to resume the playback of the PEC. Choose "PEC StrtRec?" and press the + button to resume the recording of the PEC. Choose "PEC Delete?" and press the + button to resume the deletion of the PEC. (Turning off the power will delete the recorded PEC, too.)

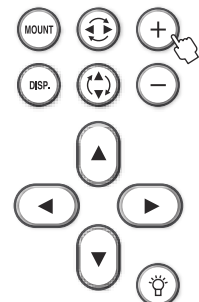

To cancel the menu, press the minus button.

## APPLICATION

### Display Menu

Pressing the DISP. button will turn up the brightness of the button itself and allows you to access various Display menus for setting with the direction keys. At the same time, it disables the direction keys for slewing the mount. Press the DISP. button again to return to slewing with the direction keys. The brightness of the DISP. button dims. The new settings are saved to the flash memory.

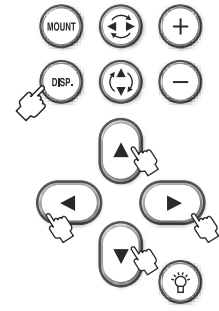

#### Contrast Adjustment

This allows for adjusting the contrast of the LCD screen on the controller. The contrast is adjustable between 1 (low) and 10 (high). The setting is defaulted to "07".

##### Procedure:

- 1 Pressing the DISP. button will turn up the brightness of the button and enable you to choose subsidiary menus. The subsidiary menu appears as you press the left or right direction key each time. Display the "Contrast LCD" to choose the contrast adjustment setting.
- 2 Pressing the up or down direction key will increase or decrease the value to set and adjust to your desired contrast setting. The new setting is saved as indicated.

Contrast  
LCD 07

#### Brightness Adjustment

This allows for adjusting the brightness of the LCD screen on the controller. The brightness is adjustable between 1 (low) and 10 (high). The setting is defaulted to "07".

##### Procedure:

- 1 Pressing the DISP. button will turn up the brightness of the button itself and enables you to choose a subsidiary menu in the Display menu. The subsidiary menu appears as you press the left or right direction key each time and display the "Bright LCD" to choose the brightness adjustment setting.
- 2 Pressing the up or down direction key will increase or decrease the value to set and adjust to your desired brightness setting. The new setting is saved as indicated.

Bright  
LCD 07

#### Backlight Adjustment

This allows for adjusting the backlight of the keys and buttons on the controller. The backlight is adjustable between 1 (low) and 10 (high). The setting is defaulted to "07".

##### Procedure:

- 1 Pressing the DISP. button will turn up the brightness of the button itself and enables you to choose a subsidiary menu in the Display menu. The subsidiary menu appears as you press the left or right direction key each time and display the "Bright Key" to choose the backlight adjustment setting.
- 2 Pressing the up or down direction key will increase or decrease the value to set and adjust to your desired backlight setting. The new setting is saved as indicated.

Bright  
Key 07

## APPLICATION

### Red LED Light Adjustment

This allows for adjusting the brightness of the red LED light on back of the controller. The brightness is adjustable between 1 (low) and 10 (high). The setting is defaulted to "07".

#### Procedure:

- 1 Pressing the LED light button will turn up the brightness of the button itself and turn on the red LED light.
- 2 Pressing the DISP. button will turn up the brightness of the button itself and enables you to choose a subsidiary menu in the Display menu. The subsidiary menu appears as you press the left or right direction key each time and display the "Bright Lamp" to choose the red LED light adjustment setting.
- 3 Pressing the up or down direction key will increase or decrease the value to set and adjust to your desired brightness setting. The new setting is saved as indicated.



Bright  
Lamp 07

## Other Functions

### Field of View Orientation

When you try to put your target celestial object in the center of the eyepiece's field of view on your telescope at high magnification, you may occasionally move the telescope in an opposite direction due to a misleading orientation in the eyepiece's field of view when you use a mirror diagonal, for example. This feature allows you to instantly reverse the direction of the direction keys.

Pressing the RA Reverse button will turn up the brightness of the button itself and allows you to reverse the direction of the RA so that you can change the tracking orientation in the field of view to an opposite direction. Press the RA Reverse button again to return the tracking to the original direction.

Pressing the DEC Reverse button will turn up the brightness of the button itself and allows you to reverse the direction of the DEC so that you can change the tracking orientation in the field of view to an opposite direction. Press the DEC Reverse button again to return the tracking to the original direction.

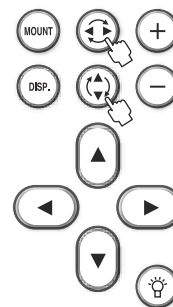

### Reset

All the settings for the mount and controller can be initialized to the defaulted settings at the Vixen factory. To reset the settings, turn on the power while pressing the plus button and the red LED light button simultaneously for more than one second. Record your necessary setting values, before you proceed to initialization.



Reset  
Memory

# APPLICATION

## Modules for the AP Mount

The AP mount is composed of sectional modules and units. It can be easily rearranged or upgraded for your specific need.

### AP Mount Composition Chart

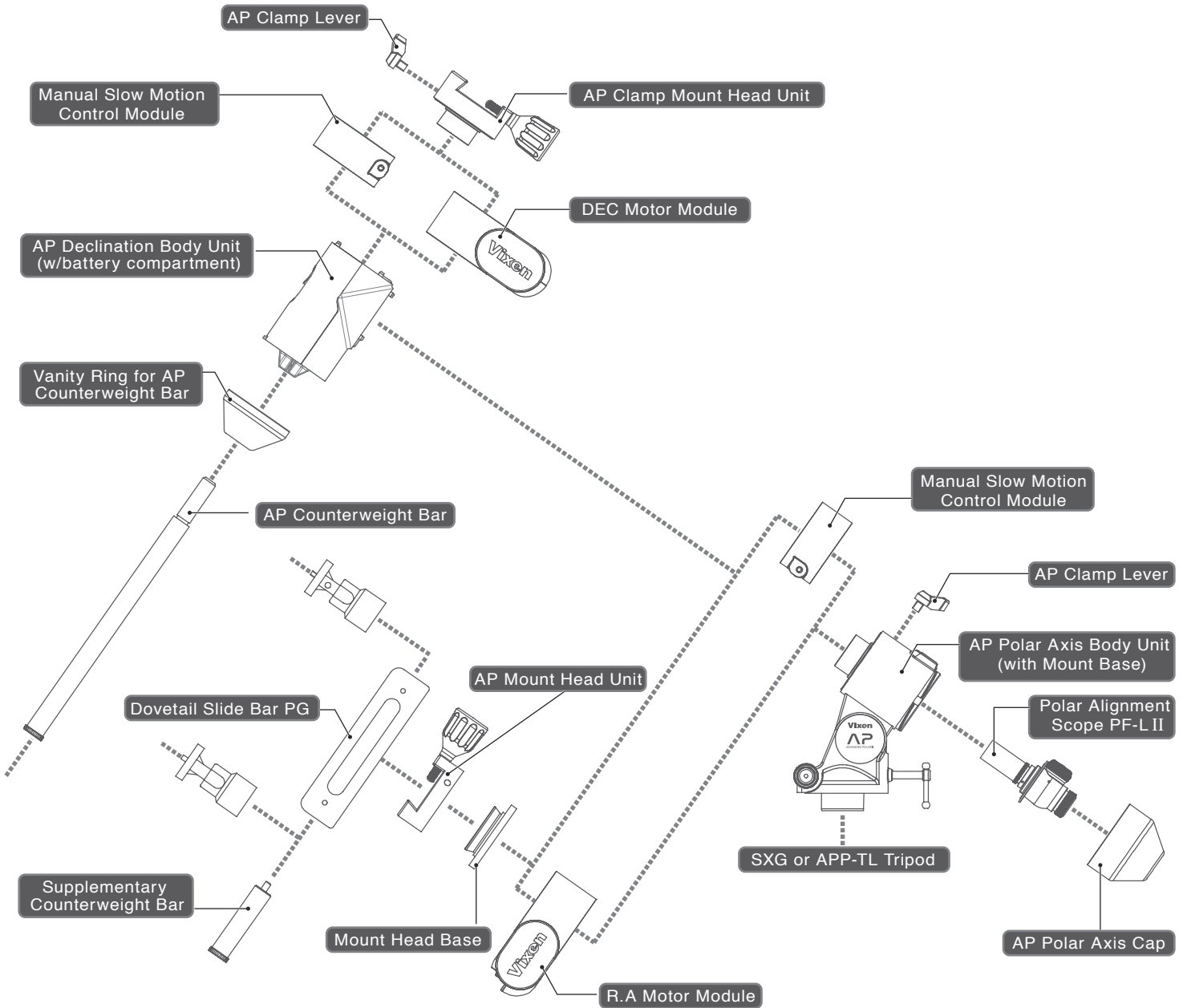

The polar axis body unit, R.A. motor and DEC motor modules are designed with internal joint electrical contacts. The modules are ready to connect to your power source when connected to each other.

The R.A. motor module is provided with the controller connecting port and external power supply port (USB Micro-B). The R.A. motor module is essential when you use the external power supply.

The AP declination body has a built-in battery compartment as a power source.



# APPLICATION

## Variations on the AP Mount

### AP Mount with Single-Axis Motor Drive

Consisting of:

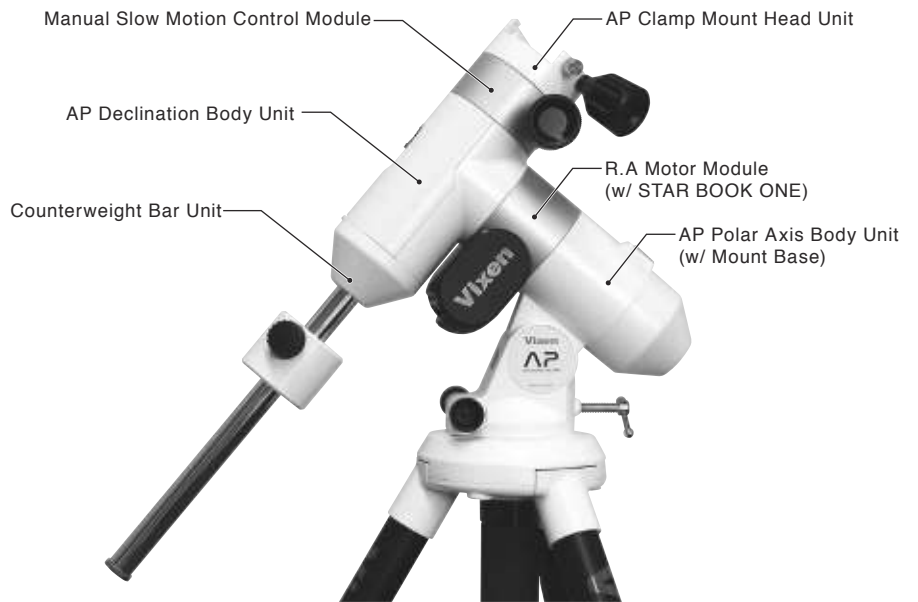
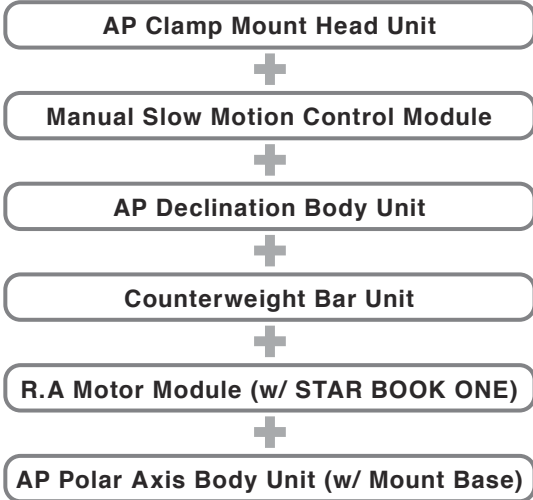

### AP Mount with Dual-Axis Motor Drive

Consisting of:

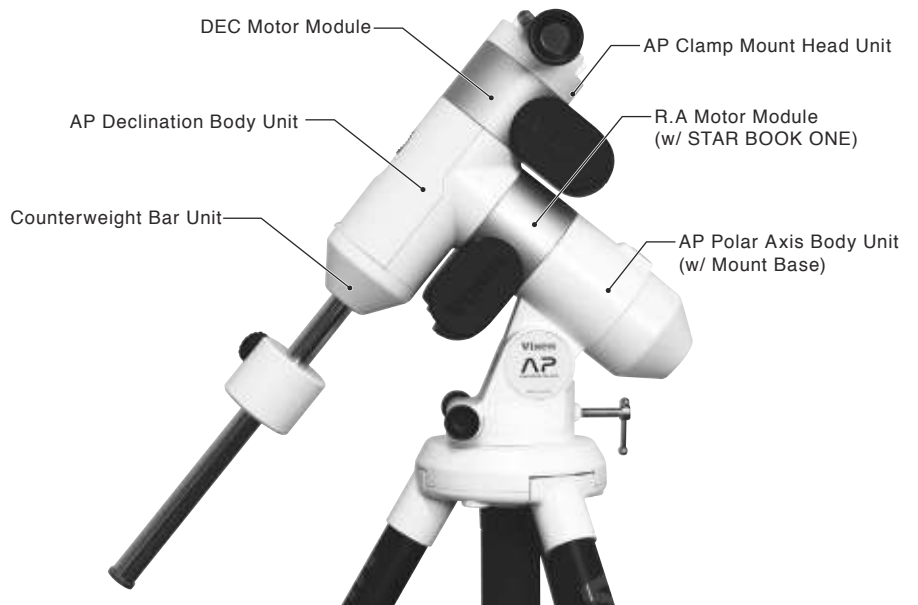
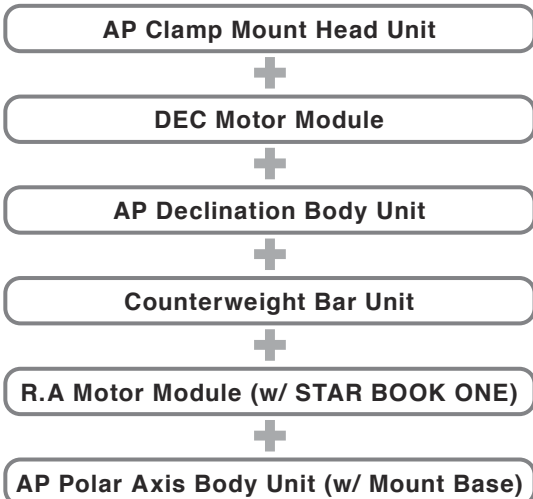

### AP Mount with Manual Slow Motion Controls

Consisting of:

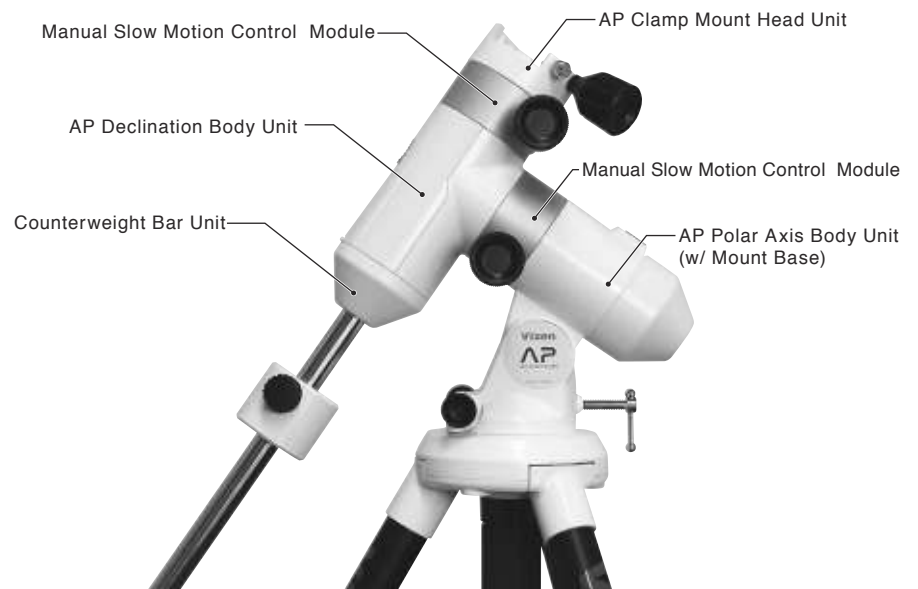
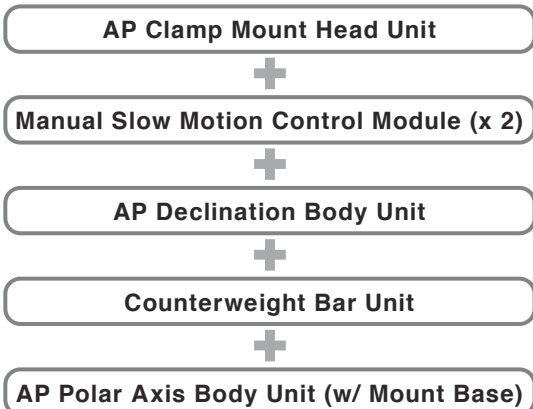

## APPLICATION

### How to Change the Modules

Remove the optical tube, counterweight bar and controller before changing modules. Take out the batteries from the battery compartment and disconnect the external power supply if it is used.

#### Case 1: Changing the R.A. Motor Module for the Manual Slow Motion Control Module

- 1 Remove the declination body cover.  
Open up the polar scope window on the declination body by sliding down the shutter. While pushing down on the hook on the bottom of the declination body, pull out the declination body cover (battery compartment cover) by pinching the hook and window hole with fingers.

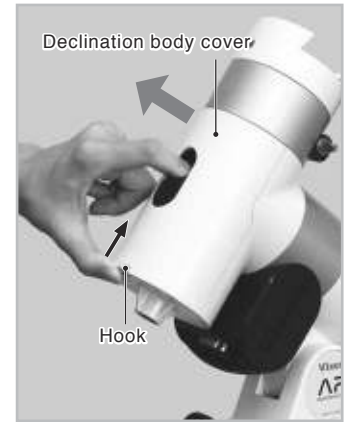

- 2 Take off the batteries from the declination body. Do not disassemble the mount without removing the batteries. This may cause damage.
- 3 Loosen the two socket head cap screws on the declination body as shown in the figure with the 4mm Allen wrench. Remove the declination body assembly. Be sure to hold the declination body securely while loosening the screws.

#### ⚠ Caution:

The internal joint electrical contact of the declination body is very delicate. Take care not to touch with fingers or other objects.

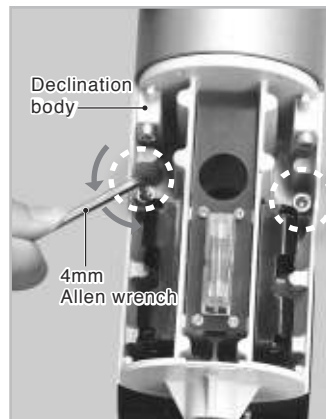

- 4 Loosen the three socket head cap screws on the R.A. motor module as shown in the figure with the 3mm Allen wrench. Remove the R.A. motor module. Be sure to hold the R.A. motor module securely while loosening the screws.



- 5 Attach the manual slow motion control module onto the polar axis body as shown in the figure so that the center hollow (larger side) of the manual slow motion control module fits snugly onto the center protruded portion of the polar axis body.

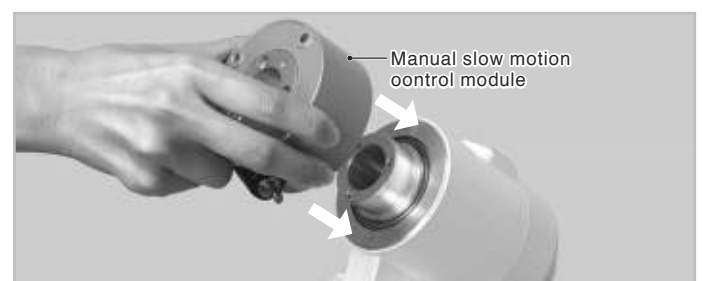

## APPLICATION

- 6 Turn the manual slow motion control module so that the screw holes (larger holes with no thread) are aligned in tandem. Replace the three socket head cap screws in place.

Tighten the screws with the 3mm Allen wrench securely.

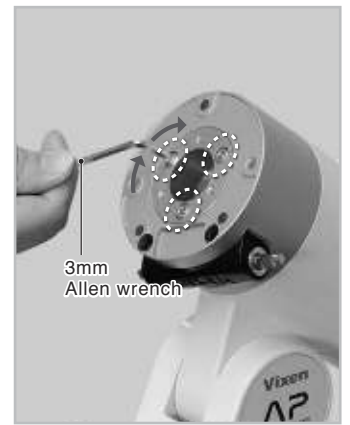

- 7 Attach the declination body assembly onto the polar axis body assembly so that the electrical contact on the declination body fits into the sunken portion on the manual slow motion control module as shown in the figure.

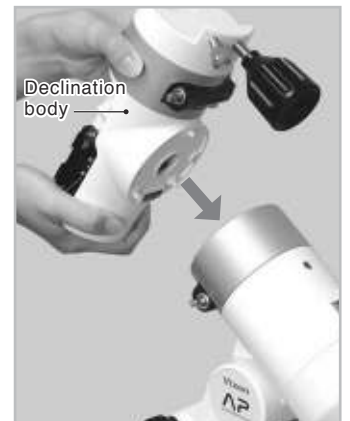
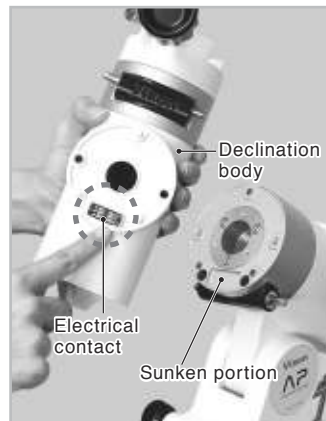

- 8 Replace the two socket head cap screws that were removed in step 2 above while holding the declination body. Install the batteries, if necessary. Tighten the screws with the 4mm Allen wrench securely.

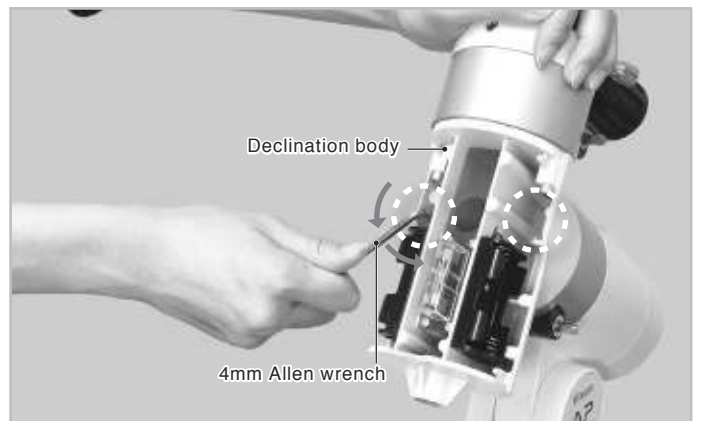

- 9 Replace the declination body cover (battery compartment cover) with attention to the direction of the hook on the cover.

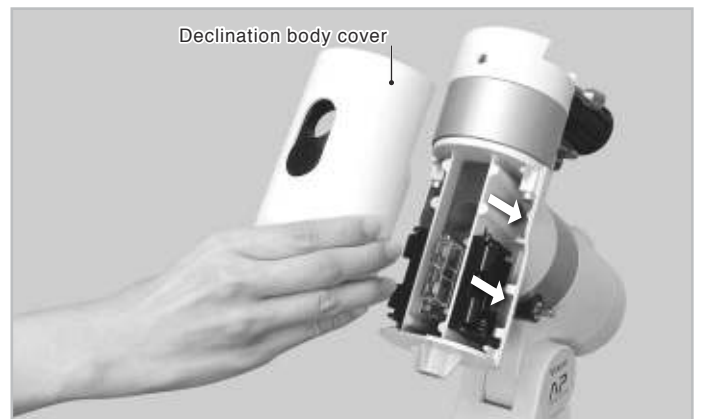

## APPLICATION

### Case 2: Changing the Manual Slow Motion Control Module for the DEC. Motor Module.

- 1 Remove the declination body cover.  
Open up the polar scope window on the declination body by sliding down the shutter. While pushing down on the hook on the bottom of the declination body, pull out the declination body cover by pinching the hook and window hole with fingers.



- 2 Remove the batteries from the declination body. Do not disassemble the mount without removing the batteries. This may cause damage.

- 3 Loosen the two socket head cap screws on the top of the declination body as shown in the figure with the 4mm Allen wrench. Remove the manual slow motion control module assembly. Be sure to hold the manual slow motion control module assembly firmly in hand while loosening the screws.

#### ⚠ Caution:

The internal joint electrical contact of the declination body is very delicate. Take care not to touch with fingers or other objects.

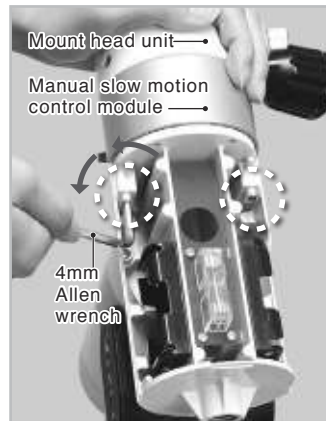

- 4 Separate the manual slow motion control module from the mount head unit. Loosen the three socket head cap screws on the manual slow motion control module as shown in the figure with the 3mm Allen wrench.

- 5 Attach the DEC motor module onto the mount head unit so that the sunken portion on the DEC motor module (opposite side of the electrical contact) fits snugly on the protruding portion on the mount head unit as shown in the figure.

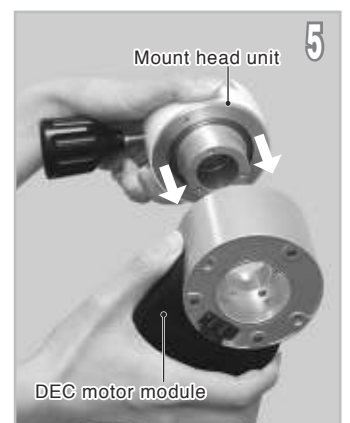

- 6 Turn the DEC motor module to change the orientation so that the screw holes (larger holes with no thread) are aligned in tandem. Replace the three socket head cap screws in place and tighten the screws securely with the 3mm Allen wrench.



## APPLICATION

- 7 Attach the declination body assembly onto the polar axis body assembly so that the electrical contact on the declination body fits snugly on the sunken portion on the manual slow motion control unit as shown in the figure.

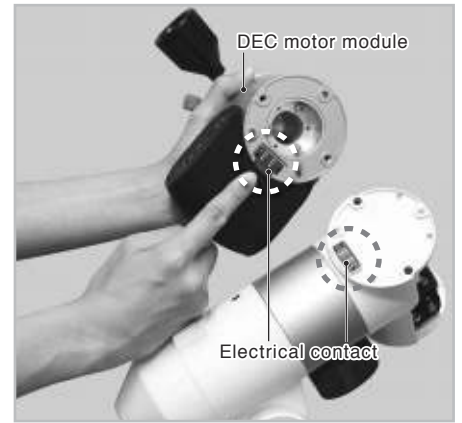

- 8 Replace the two socket head cap screws that were removed in step 3 above while holding the DEC motor module. Install the batteries, if necessary. Tighten the screws with the 4mm Allen wrench.

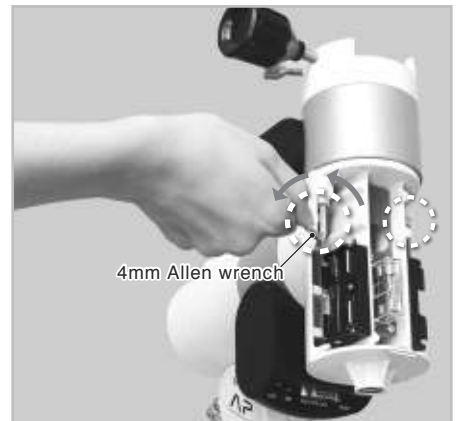

- 9 Replace the declination body with attention to the direction of the hook on the cover.



## APPLICATION

### Case 3: Changing the Manual Slow Motion Control Module for the R.A. Motor Module

- 1 Remove the declination body cover.  
Open up the polar scope window on the declination body by sliding down the shutter. While pushing down on the hook on the bottom of the declination body, pull out the declination body cover by pinching the hook and window hole as shown in the figure.

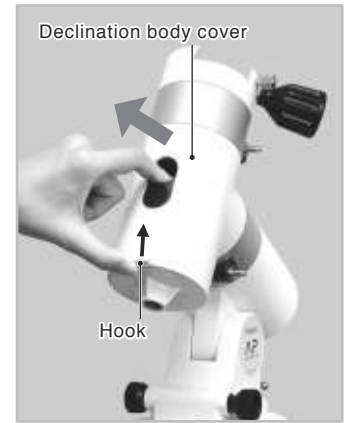

- 2 Remove the batteries from the declination body. Do not disassemble the mount without removing the batteries. This may cause damage.
- 3 Loosen the two socket head cap screws on the declination body as shown in the figure with the 4mm Allen wrench. Remove the declination body. Be sure to hold the declination body in hand securely while loosening the screws.

#### ⚠ Caution:

The internal joint electrical contact of the declination body is very delicate. Take care not to touch with fingers or other objects.

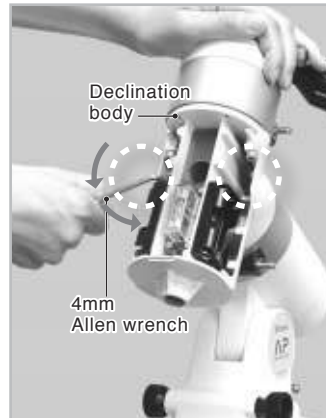

- 4 Loosen the three socket head cap screws on the manual slow motion control module with the 3mm Allen wrench. Remove the manual slow motion control module.



- 5 Attach the R.A. motor module onto the polar axis body so that the electrical contact faces to the outside as shown in the figure.

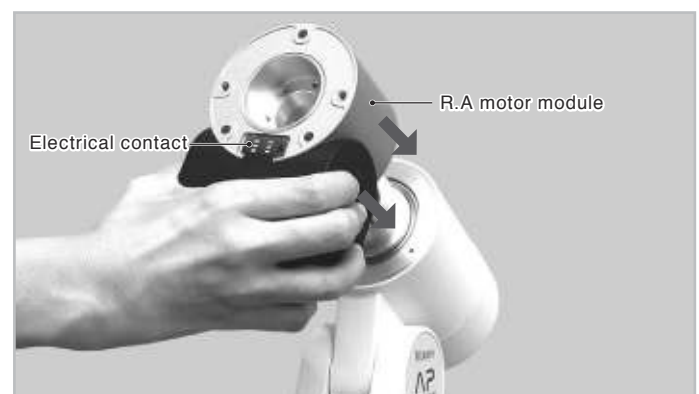

## APPLICATION

- 6 Turn the R.A. motor module to change the orientation so that the screw holes (larger holes with no thread) are aligned in tandem. Replace the the three socket head cap screws in place and tighten the screws securely with the 3mm Allen wrench.

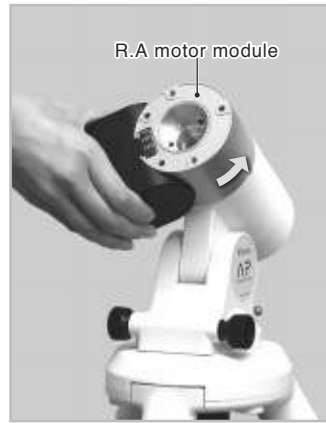

- 7 Attach the declination body onto the polar axis body assembly so that the electrical contact on the declination body fits the counterpart on the R.A. motor module as shown in the figure.

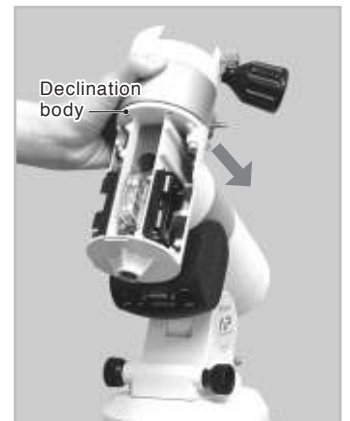

- 8 Replace the two socket head cap screws that were removed in step 3 above while holding the declination body. Install the batteries, if necessary. Tighten the screws with the Allen wrench of 4mm on a side securely.

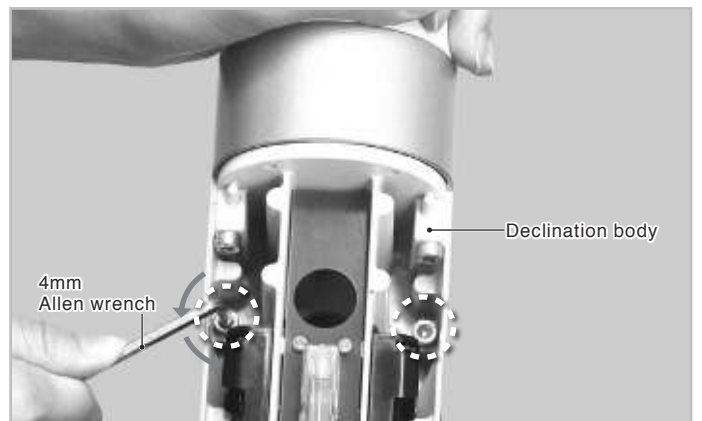

- 9 Replace the declination body cover in place noting the direction of the hook on the cover.



## APPLICATION

### Upgrading the AP Photo Guider to the AP Mount with Dual-axis Motor Drive

#### Necessary Parts (Optional)

- AP Clamp Mount Head Unit
- DEC Motor Module
- AP Declination Body Unit
- Counterweight Bar Unit
- Counterweight

**1** Loosen the 3 setscrews on the side of the mount head with the 4mm Allen wrench. Remove the mount head. The mount head base (black) is exposed.

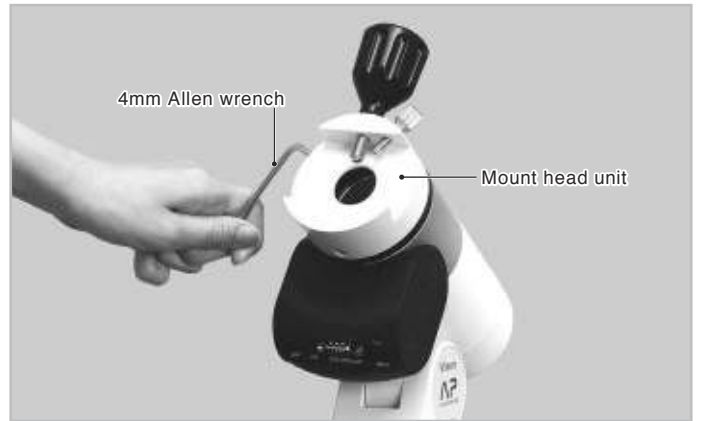

**2** Loosen the two screws on the mount head base with the 4mm Allen wrench and remove the mount head base.



**3** Attach the AP declination body unit onto the exposed R.A. motor module.

To remove the declination body cover, open up the polar scope window on the declination body by sliding down the shutter. While pushing down on the hook on the bottom of the declination body, pull out the declination body cover by pinching the hook and window hole as shown in the figure.

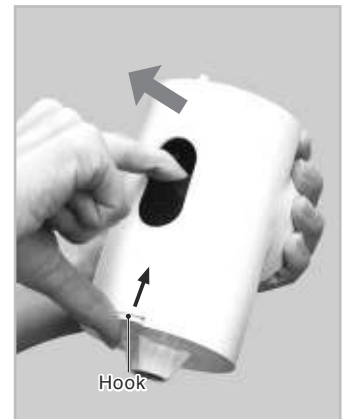

**4** Attach the declination body onto the R.A. motor module so that the electrical contact on the declination body fits snugly onto the counterpart on the R.A. motor module as shown in the figure.

#### ⚠ Caution:

The internal joint electrical contact of the declination body is very delicate. Take care not to touch with fingers or other objects.

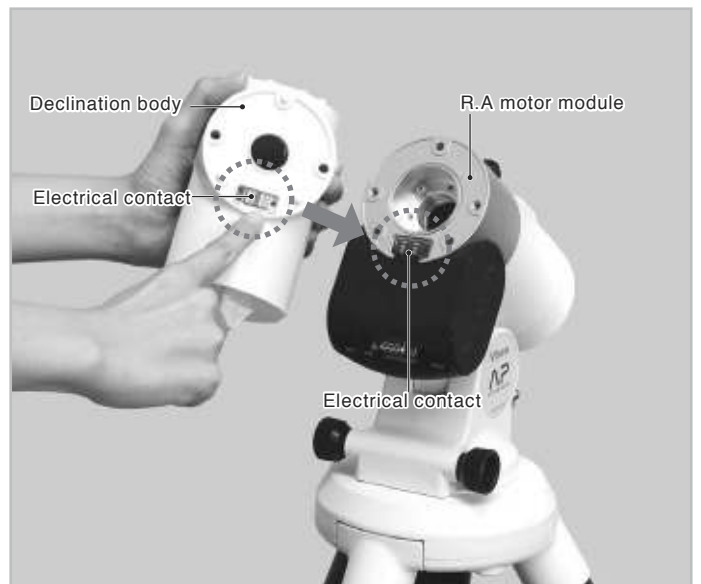
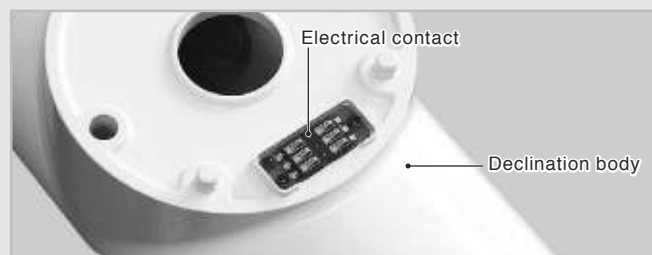



## APPLICATION

- 5 While holding the declination body, attach the declination body securely with the two supplied M5-25mm long screws using the 4mm Allen wrench.

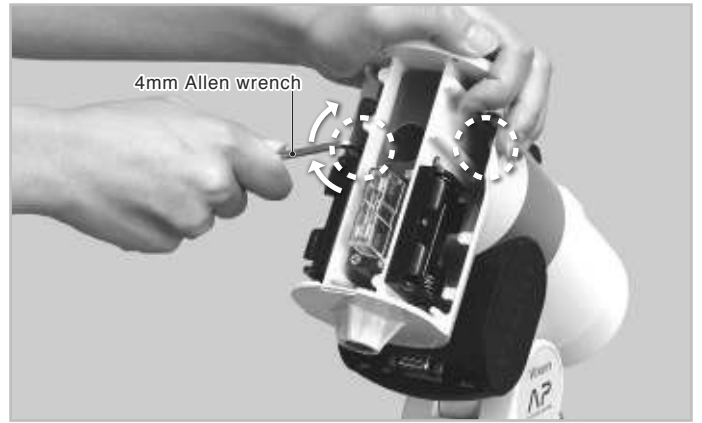

- 6 Attach the AP clamp mount head unit onto the DEC motor module with the electrical contact on the outside so that the central protruding portion of the AP clamp mount head fits snugly onto the central hollow portion of the DEC motor module as shown in the figure.

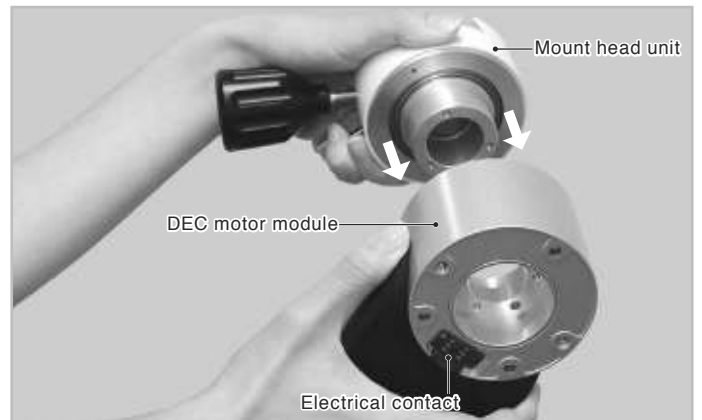

- 7 Turn the DEC motor module to change the orientation so that the screw holes (larger holes with no thread) are aligned in tandem. Attach the DEC motor module with the three supplied socket head cap screws securely using the 4mm Allen wrench.

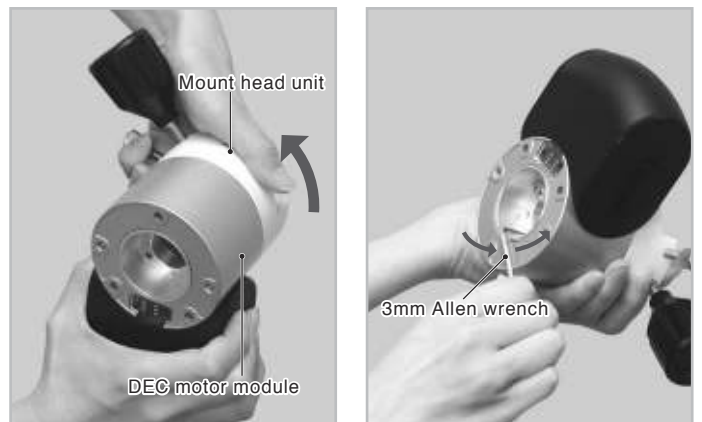

- 8 Attach the DEC motor module assembly onto the declination body so that the electrical contact on the DEC motor module fits snugly onto the counterpart on the declination body as shown in the figure.

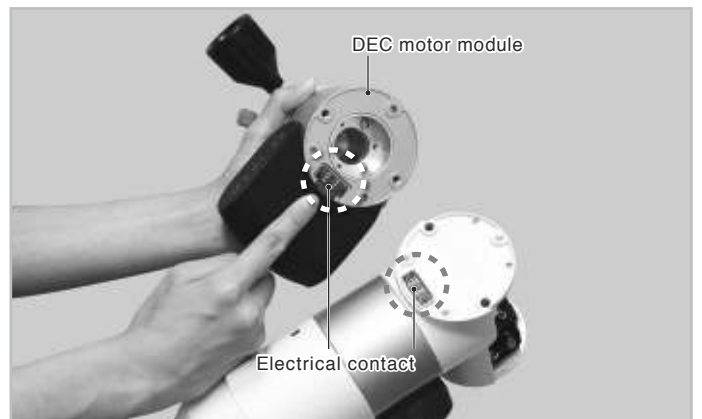

### ⓘ Caution:

The internal joint electrical contact of the declination body is very delicate. Take care not to touch with fingers or other objects.

## APPLICATION

- 9 While holding the DEC motor module, fix the declination body securely with the two supplied M5-25mm long screws using the 4mm Allen wrench. Install the batteries, if necessary.

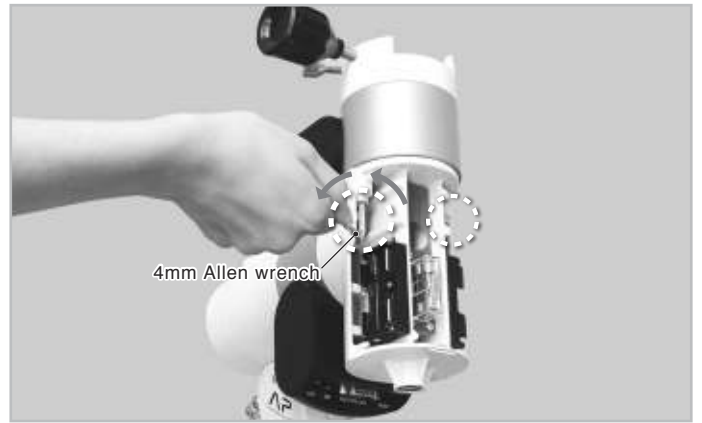

- 10 Replace the declination body cover with attention to the direction of the hook on the cover.



- 11 Screw the threaded end of the counterweight bar into the threaded hole on the vanity ring. After you fully tighten the vanity ring, unscrew the counterweight bar by one rotation.

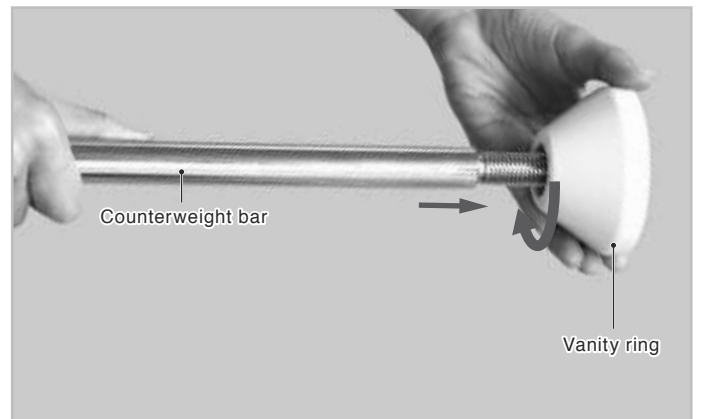

- 12 Screw the threaded end of the counterweight bar into the declination body. Attach the declination body fully and securely tighten the up the vanity ring.

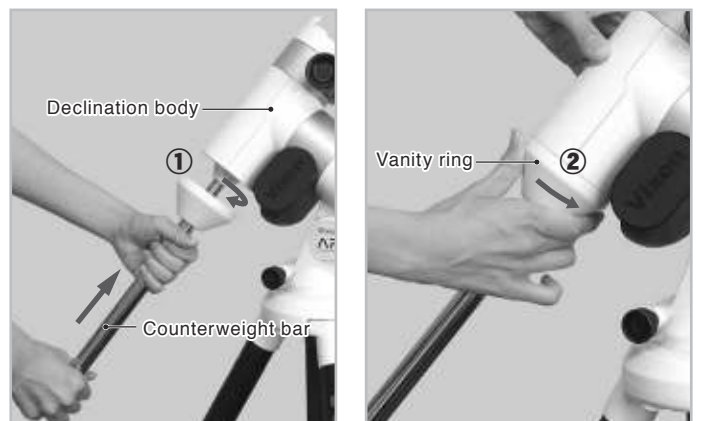

## APPLICATION

### About a Fuse Box

In the AP mount, the electrical circuit board is protected by a fuse. It is a rare case that a fuse is cut off in general use of the mount. If this happens, you will need to replace the fuse with a fresh one.

**Specifications:**  
**125V 1A Class-B (PES standard)**  
**6mm dia. x 30mm**

### Replacing the Fuse

- 1 Remove the declination body cover.  
Open up the polar scope window on the declination body by sliding down the shutter. While pushing down on the hook on the bottom of the declination body, pull out the declination body cover by pinching the hook and window hole with fingers.

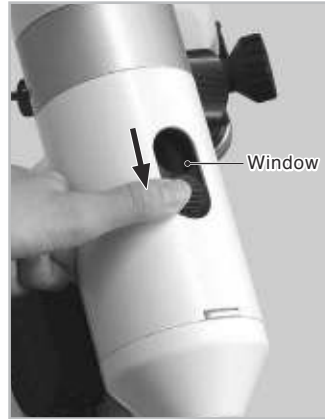

- 2 Remove the batteries from the declination body. Do not disassemble the mount without removing the batteries. This may cause damage.

- 3 Remove the cover of the fuse box.

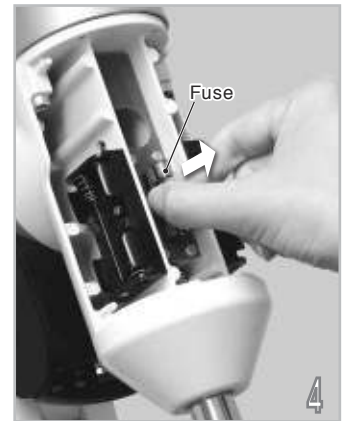

- 4 Pull out the fuse.

- 5 Push a new fuse into the fuse box to set.

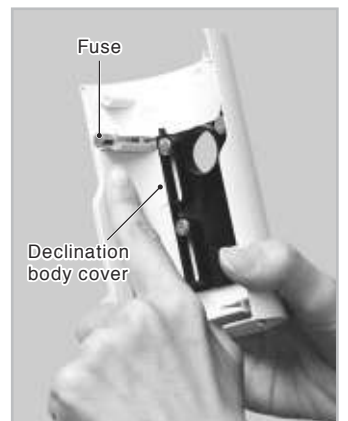
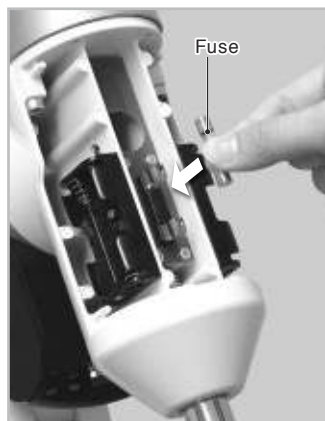

- 6 Put the cover on the fuse box and install the batteries, if necessary.

- 7 Replace the declination body cover noting the direction of the hook on the cover.



# SPECIFICATIONS

## Connectors on the STAR BOOK ONE

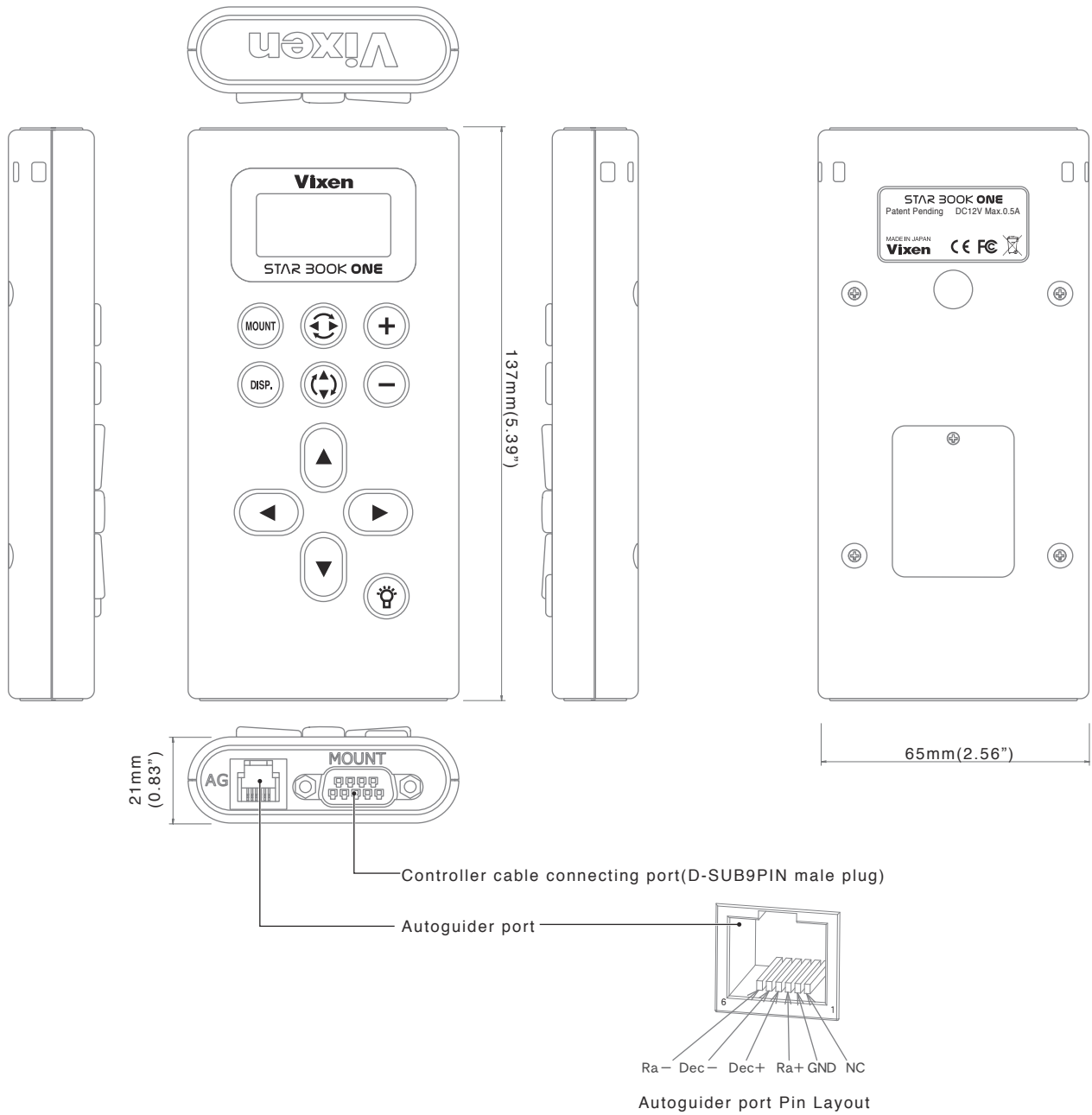

## R.A motor module power supply port

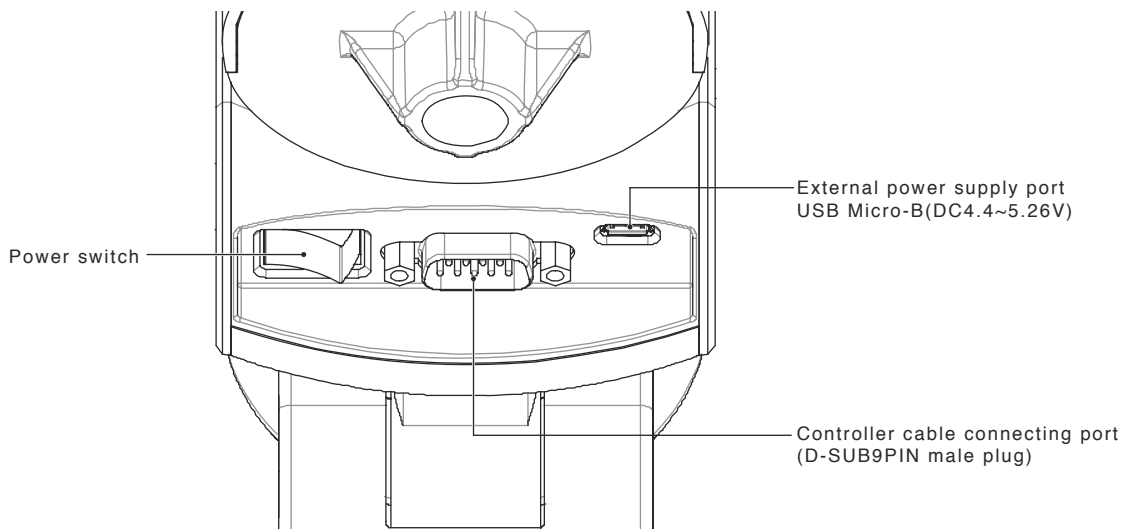

# SPECIFICATIONS

## AP Mount Dimensions

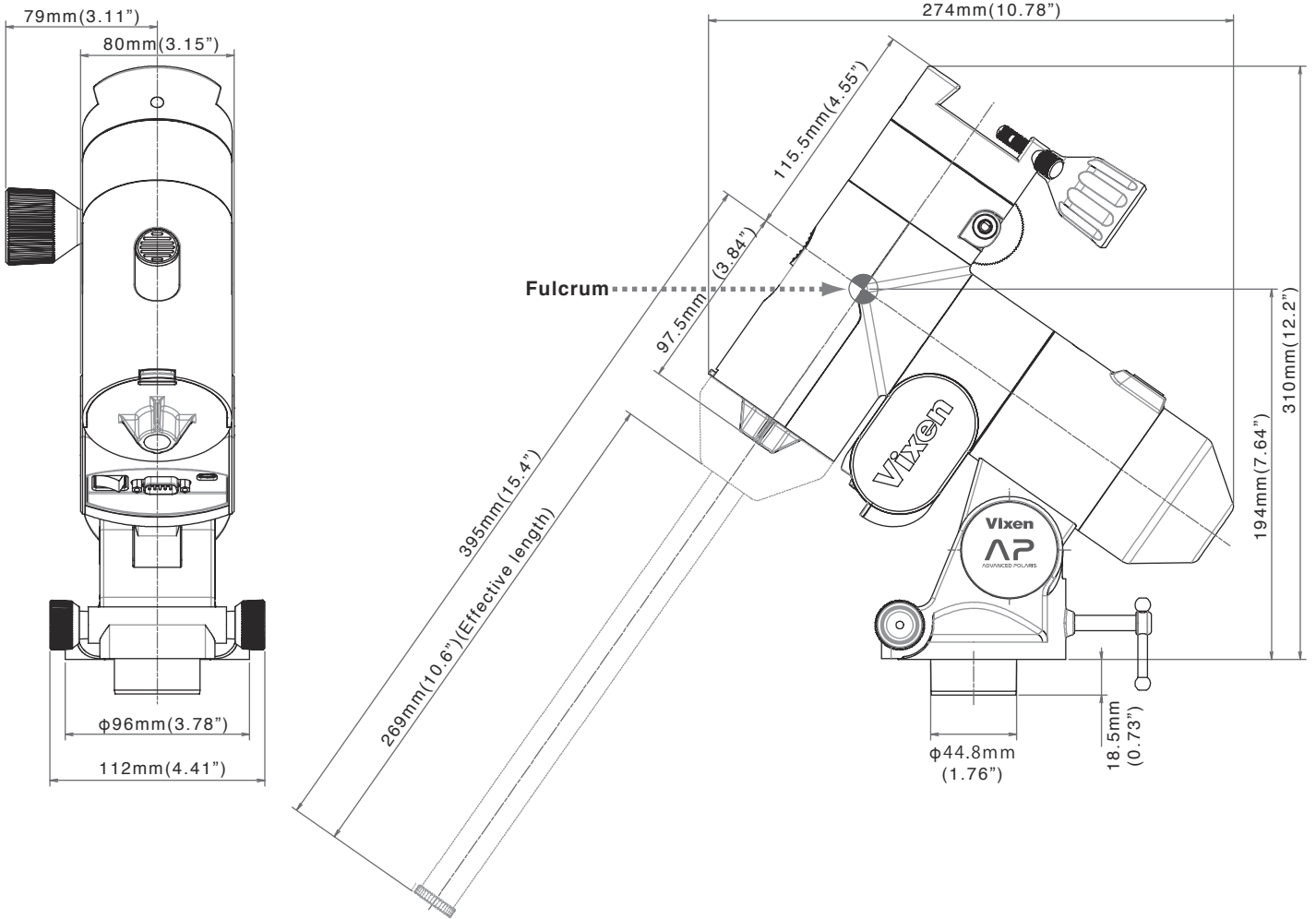

## R.A Motor Module Dimensions

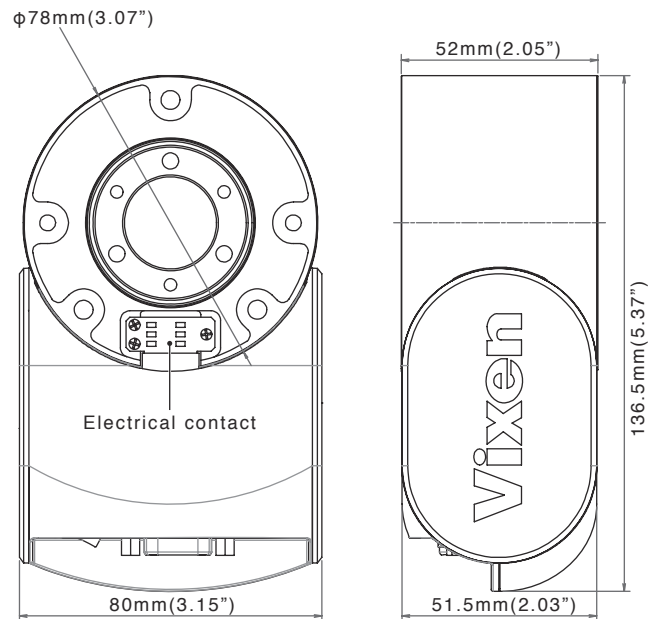

## DEC Motor Module Dimensions

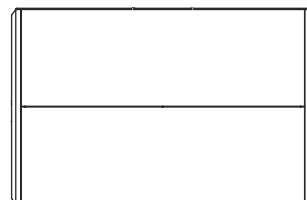
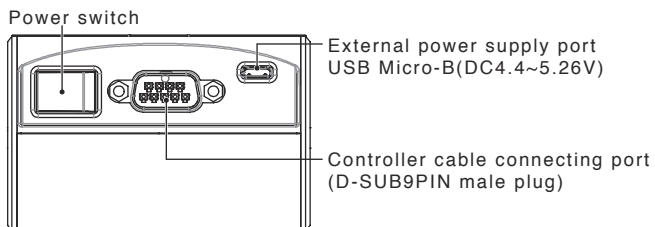
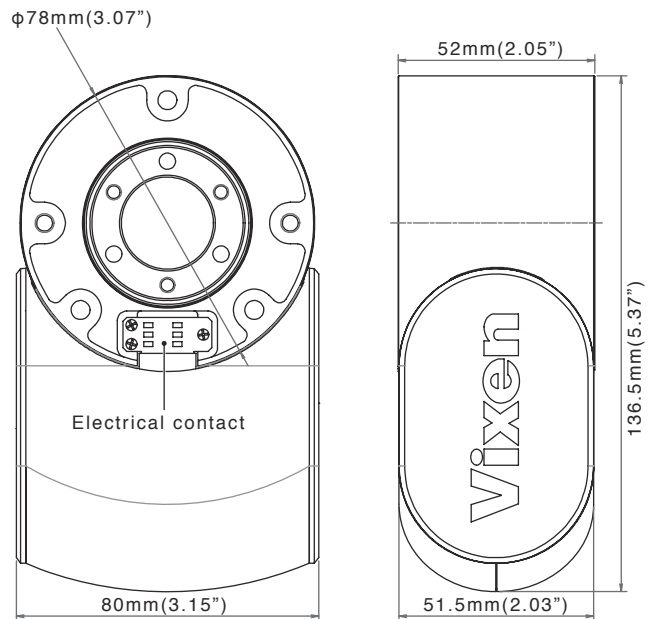

# SPECIFICATIONS

## Manual Slow Motion Control Module Dimensions

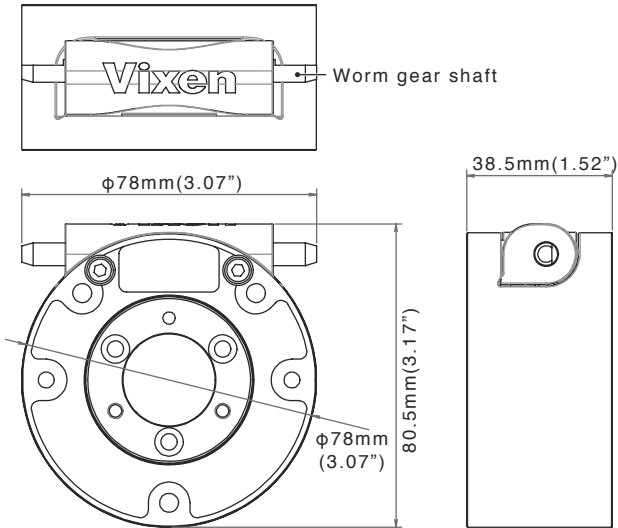

## APP-TL130 Tripod Dimensions

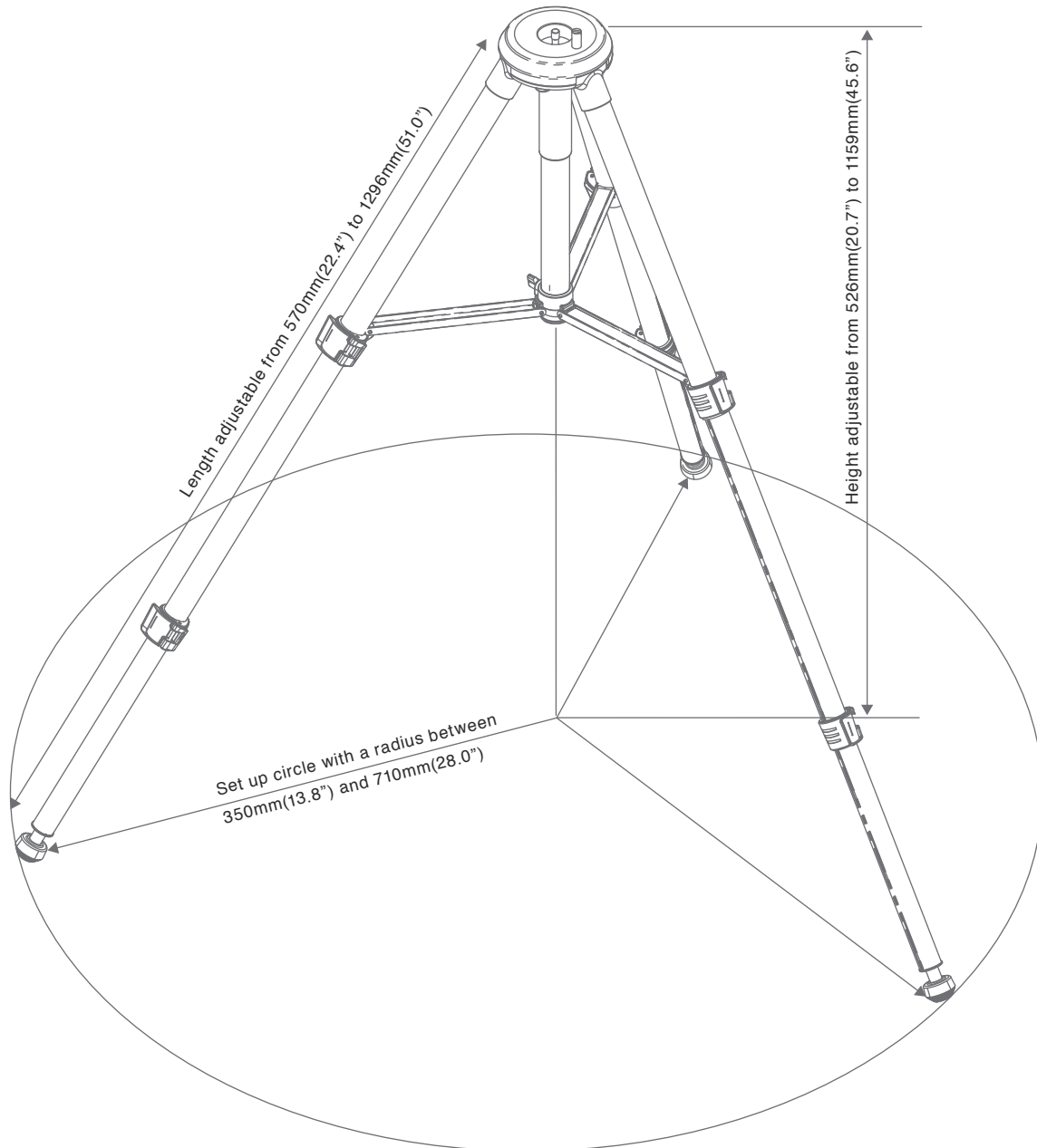



**Vixen<sup>®</sup>**