

# Vixen®

## Instruction Manual for SXD2 Equatorial Mount



## **PREFACE**

### **Thank you for your purchase of the Vixen SXD2 equatorial mount.**

The SXD2 equatorial mount is a high precision sturdy mount ideal for astrophotography. The cutting-edge STAR BOOK TEN Hand Controller features a high definition large color LCD screen with intuitive controls to help you enjoy your astronomical observation.

\*The manual describes the functions and uses of the SXD2 equatorial mount and various Vixen Telescopes. You may occasionally find descriptions not relevant to your model.

\*Use this instruction manual in conjunction with your telescope manual.

\*Features may be updated or new functions added. Please visit Vixen's website for the latest software updates.

\*Use the correct power source for the SXD2 equatorial mount or the optional AC Adapter sold separately.

### **Carefully read the instructions before use.**

\*Follow the instructions precisely.

\*Keep this manual nearby to find quick answers to questions.

\*This instruction manual will assist you in the safe use of the SXD2 equatorial mount.

## **WARNING!**

**Never look directly at the sun with your naked eyes or through your telescope and finder scope. Permanent and irreversible eye damage may result.**

\*This equipment has been tested and found to comply with the limits for a Class B digital device, pursuant of Part 15 of the FCC rules.

## **CAUTION**

\*Do not try to restrain the movement of the mount when in operation, which may lead to injuries to you or damage to your equipment.

\*Do not use the product in a wet environment.

\*Do not turn on the power switch of the mount under circumstances when internal condensation is suspected on the equipment. It may cause a failure by a short circuit.

\*Do not attempt to disassemble or alter any part of the equipment that is not expressly described in this manual. This could damage the mount, result in electrical shock or lead to injury.

\*Do not use the D-sub 9pin cable of the STAR BOOK TEN to connect to other equipment such as a PC. It may cause a failure, heating, or electrical shock

## **HANDLING and STORAGE**

\*Do not expose the product to rain, water drops, dirt or sand.

\*When cleaning, do not use solvent such as paint thinners.

\*For storage, keep the product in a dry place, and do not expose to direct sunlight.

\*Remove the batteries from the battery compartment if the product is not used for a long time.

**PREFACE** ----- P 2

**TABLE OF CONTENTS**----- P 3

**BEFORE USE** ----- P 4

Checking the Package Contents ----- P 4

SXD2 Mount Components ----- P 5

STAR BOOK TEN Components ----- P 7

Screen Menus and Instructions ----- P 8

Flow of Operation ----- P 9

**Chapter 1**

**PREFACE** ----- P 2

About the Internal Battery of STAR BOOK TEN -----P10

Assembling the Mount -----P11

I. Setting up the Tripod -----P11

II. Attaching the Equatorial Mount -----P12

III. Attaching the Counterweight -----P13

IV. Attaching the Optical Tube -----P14

V. Balancing the Equatorial Mount -----P15

VI. Connecting the STAR BOOK Cable -----P18

VII. Connecting the Power Cable -----P18

**Chapter 2**

**INITIAL SETTING** ----- P19

I . Turning ON the Power -----P19

II . Setting/Language -----P19

III . Setting Local Time -----P20

    Time Zone -----P20

IV . Setting Location -----P21

**Chapter 3**

**BASIC OPERATION** -----P23

Moving the Telescope -----P23

Changing the Go-To Slewing Speed -----P23

**Chapter 4**

**AUTOMATIC GO-TO SLEWING** ----- P24

Startup Procedure - - - - - P24

    I . Locating the SXD2 Mount - - - - - P25

    II . Home Position - - - - - P25

    III . Alignment - - - - - P26

    IV . Slewing to an Object in SCOPE MODE - - - - - P31

    V . Slewing to an Object in CHART MODE - - - - - P32

    VI . Slewing with Command Keys - - - - - P34

        1 SOLAR key - - - - - P34

        2 NAMED key - - - - - P34

        4 M key - - - - - P34

        5 NGC/IC key - - - - - P34

        6 STAR key - - - - - P34

    Moon Map - - - - - P35

        Calling up the Moon Map - - - - - P35

        Using the Moon Map - - - - - P36

    Example: Go-To slewing with the NGC/IC key - - - - - P42

    Object Menu - - - - - P43

        7 OBJECT key - - - - - P43

        Recently Located Objects - - - - - P43

        Constellation - - - - - P44

        Coordinates - - - - - P45

        Comet - - - - - P46

        Satellite(Artificial Satellite)- - - - - P47

        User Coordinates - - - - - P50

        Home Position - - - - - P51

**Chapter 5**

**APPLICATION** -----P52

    I. How to Use the Polar Axis Scope ----- P52

        Polar Alignment ----- P52

        Precise Polar Alignment ----- P57

        Change the Altitude Setting on the SXD2 Mount ----- P58

    II. Initial Configuration ----- P59

        Use Last Mount Setting ----- P59

        LCD Adjustment ----- P59

        Night Vision ----- P60

        Key LED Brightness ----- P60

        Volume ----- P61

        Atmospheric Refraction ----- P61

        Language ----- P62

        Initialize Memory Data ----- P62

        About StarBook TEN ----- P63

        About LAN ----- P63

    III. System Menu (Main menu) ----- P64

        Chart Setting ----- P64

            Display Style ----- P64

            Constellation ----- P65

            Display of Star ----- P66

            Star Popular Name ----- P67

            Bayer Designation ----- P68

            Sun, Moon, Planet ----- P69

            Comet ----- P69

            Satellite ----- P70

            RADEC Grids ----- P70

            Center Circle ----- P71

            Catalogue Objects ----- P71

        Mount Setting ----- P73

            Direction Key ----- P73

                AltAz ----- P73

                RADEC ----- P73

                X-Y ----- P73

            Auto Guider ----- P74

            PEC (Periodic Error Corrcion) ----- P75

            Backlash Compensation ----- P78

            GOTO Speed ----- P80

            Polar Scope Light ----- P80

            Motor Power ----- P81

            Mount Type ----- P82

            Cross Over Meridian ----- P83

            Delete Align Point Data ----- P85

            Following Object ----- P85

        System Setting ----- P86

            GOTO Message ----- P87

            Expansion Function ----- P88

            Mount Information ----- P89

    IV. Using as a Stand-alone Unit ----- P90

        Connecting to LAN ----- P90

        Requirements ----- P90

    V . Updating your STAR BOOK TEN ----- P91

    VI. Entering Orbital Elements and User Defined Objects ---- P93

**Appendix** ----- P97

## BEFORE USE

### Checking the Package Contents

The SXD2 Equatorial mount package contains the items listed below. Check if all the items are included.

#### Package Consisting of :

SXD2 Equatorial Mount	1
SX Counterweights 3.7kg and 1.9kg	1
STAR BOOK TEN Hand Controller	1
STAR BOOK Cable	1
Ferrite Core for LAN cable	1
Phillips Head Screwdriver	1
Allen Wrenches; one each of 5mm and 0.5 inch	1
Cigarette-lighter Plug Cord	1
Strap for STAR BOOK TEN	1
CR2032 Battery for STAR BOOK TEN's built-in clock	1
(Checking Purpose Only)	
SXD2 Instruction Manual (This book)	1

Note:

\* Your SXD2 mount package may differ when you purchase it as a complete telescope package.

\* A power supply unit is sold separately.



## Basics of Equatorial Mounts

### What is an Equatorial Mount?

In the northern hemisphere, stars appear to turn around the polar star (the north celestial pole) making approximately one rotation per day. This is called diurnal motion and occurs because the earth turns on its own axis once a day. The equatorial mount is a platform which is designed to rotate parallel to earth's rotational axis.

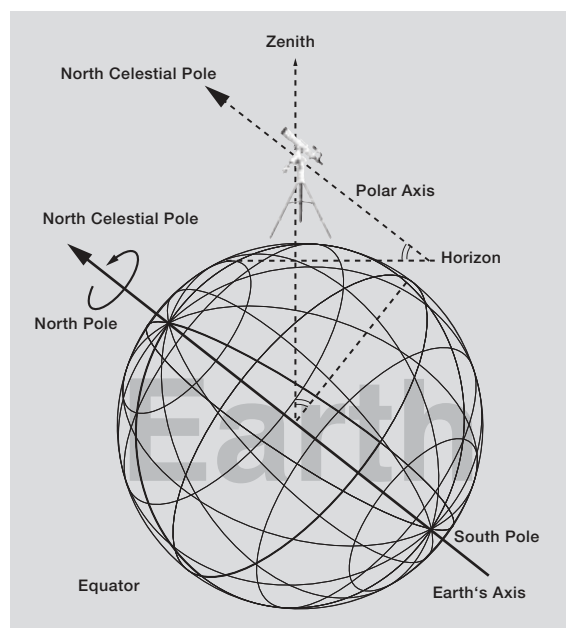

### Basic movement of the SXD2 Mount

Every movement of the electrically driven SXD2 Mount is fully controlled by the STAR BOOK TEN hand controller. The mount will perform smooth and accurate movements when each component on the mount is balanced correctly. An unbalanced mount may cause vibrations and can result in tracking errors or failure of rotational mechanisms. Make sure that the telescope is well balanced.

## CAUTION

**Do not rotate the mount manually without loosening the clamp levers.**

The SXD2 mount has clamps which allow you to rotate the Right Ascension (R.A) and Declination (DEC) axes freely for quick set up for home position and compact storage of the mount. Remember to tighten the clamp levers when you use the mount. The clamp levers should be loosened to protect the inner gear train for storage and when you transport the mount.

Never connect the STAR BOOK cable to other equipment such as a PC. This could result in electrical shock, fire, or damage to the equipment. (The specifications of the STAR BOOK cable are not compatible with RS232C (D-SUB 9PIN) connectors.)

Be careful not to bang the mount against other objects. This could damage the gears and bearings.

# BEFORE USE

## SXD2 Mount Components

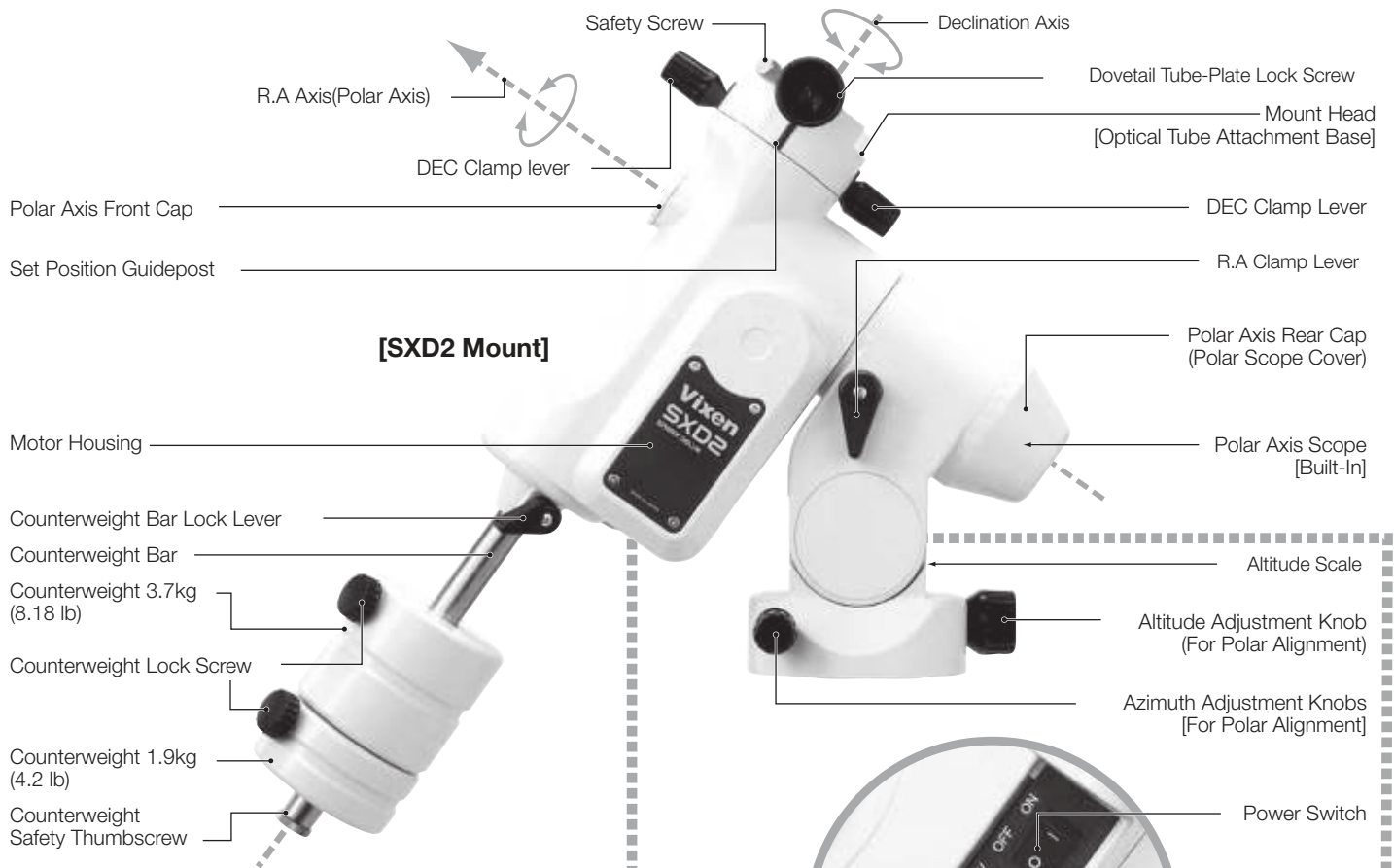

### [SXD2 Mount series telescope package with optical tube and tripod]

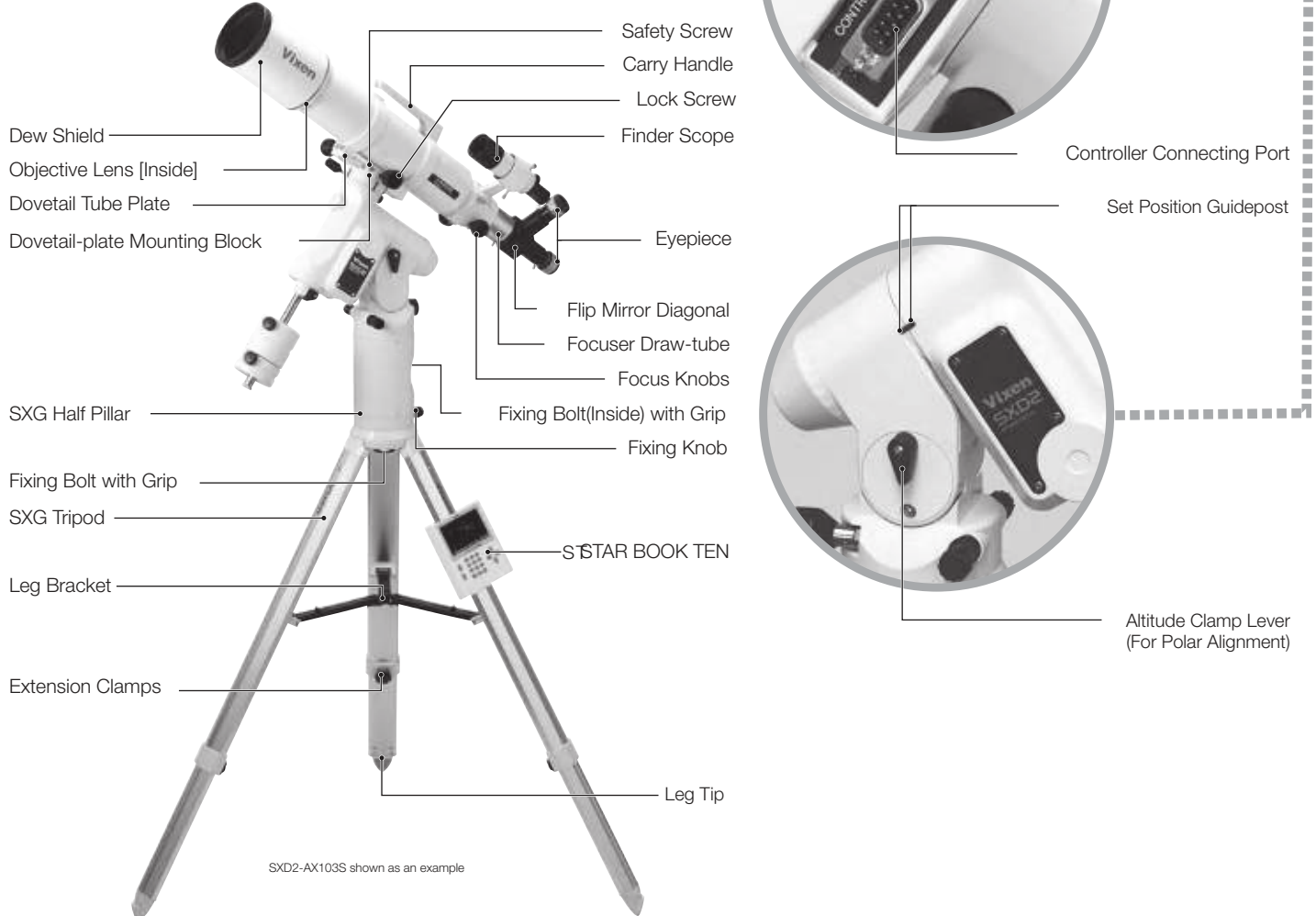

**SXD2 Mount Specifications**

<b>Mount</b>	<b>SXD2 Equatorial Mount</b>
<b>R.A Slow Motion</b>	180-tooth full circle micro-movement gear, 72mm in diameter, Brass wheel
<b>DEC Slow Motion</b>	180-tooth full circle micro-movement gear, 72mm in diameter, Brass wheel
<b>Worm Gears</b>	9mm in diameter, Brass
<b>R.A Axis</b>	35mm in diameter, Carbon steel
<b>DEC Axis</b>	40mm in diameter, Carbon steel
<b>Number of Bearings</b>	9 pieces
<b>Counterweight Bar</b>	20mm in diameter, Retractable
<b>Polar Axis Scope</b>	Built-in 6x20mm scope, FoV 8 degrees, Bubble level, Illuminated reticle, Setting accuracy within 3 arc minutes, Time graduation circle: 10 arc minutes increments between 16h and 8h (the following day) Date graduation circle: 2-day increments Meridian offset circle: Adjustable between E20 degrees and W20 degrees in 5-degree increments Northern hemisphere: Polaris guide scale (Applicable to year 2025) Southern hemisphere: Octant 4 stars pattern
<b>Azimuth Adjustment</b>	Fine adjustments: About ±7 degrees Twin tangent screws/knobs: About 1.2 degrees per rotation
<b>Altitude Adjustment</b>	Latitude between 0 degree ~ 70 degrees, 3-altitude zone setting (high, middle and low latitude, adjustment range: ±15 degrees in each zone), Altitude Scale:2-degree increments, Twin T-bar handles: 0.8 degrees per rotation
<b>Drive Motor</b>	Stepping (Pulse) motors with 250PPS
<b>Automatic Slewing</b>	High precision “GOTO” slewing with STAR BOOK-TEN, 1000x sidereal rate at maximum
<b>Maximum Astrophotography Payload</b>	15kg (33 lb), (375kg•cm torque load = About 15kg at a point of 25cm from the fulcrum)
<b>Controller Cable Connection Port</b>	D-SUB 9PIN male plug
<b>Power Connecting Port</b>	DC12V EIAJ RC5320A Class4
<b>Electricity Consumption</b>	DC12V • 0.45~2.2A(at 10kg payload), 0.6A~2.5A (at 15kg payload)
<b>Dimensions</b>	343 x 360 x 128mm
<b>Weight</b>	9.2kg (20.2 lb), excluding counterweights
<b>Counterweights</b>	3.7kg (8.15 lb) x 1pc and 1.9kg (4.2 lb) x 1pc
<b>Optional Accessories</b>	SXG-HAL130 Tripod, SXG Half Pillar, AXG-P85 Pillar, AC Power Source

**STAR BOOK-TEN Specifications**

<b>Hand Controller</b>	<b>STAR BOOK TEN</b>
<b>CPU</b>	32bit RISC Processor 324MHz SH7764
<b>Display</b>	5-inch TFT, WVGA(800x480 pixels) 65,536 colors, with backlight
<b>Power Connecting Port</b>	DC12V EIAJ RC5320A Class4
<b>Autoguider Port</b>	6-pole 6-wired modular jack (For external Autoguider)
<b>LAN Port</b>	10BASE-T
<b>Controller Cable Connection Port</b>	D-SUB9PIN male plug
<b>Expansion Slot</b>	For Advance Unit sold separately
<b>R.A &amp; DEC Display Unit</b>	R.A: 1-arc second , Decl.: 0.1-arc. minute
<b>Power Supply</b>	DC12V (Supplied from the mount side.)
<b>Built-in Clock Battery</b>	CR2032x1
<b>Electricity Consumption</b>	12V•0.5A (Stand alone use)
<b>Operating Temperature</b>	0~40°C (104 F)
<b>Dimensions</b>	169mmLx154mmW x30mmH
<b>Weight</b>	380g (13.4 oz) (Excluding the built-in battery, cable and optional Advance Unit.)
<b>Celestial Object Database</b>	272,342 (SAO: 258997, NGC objects: 7840, IC objects: 5386, Messier objects: 109*, 7 Planets, 1 quasi-planet, the Moon and the Sun)  *M40 is a missing number. M91 and M102 are listed as NGC4548 and NGC5866 in the database respectively
<b>Menus and Major Functions</b>	Automatic GoTo Slewing, Sidereal tracking and different tracking speeds for the Sun, the Moon, planets, comets and artificial satellites, Backlash compensation, PEC, Autoguider, Night vision mode, Screen brightness control, Hibernate mode, Built-in speaker, LAN connecting update and more.  Applicable OS: Microsoft Windows® XP Home Edition Service Pack 3 Microsoft Windows® XP Professional Service Pack 3 Microsoft Windows® Vista HomeBasic Microsoft Windows® Vista HomePremium Microsoft Windows® Vista Business Microsoft Windows® Vista Ultimate  Microsoft Windows® 7 HomePremium Microsoft Windows® 7 Professional Microsoft Windows® 7 Ultimate Microsoft Windows® 8 Microsoft Windows® 8 Pro  *Not applicable to MacOS, Linux and Unix

# BEFORE USE

## STAR BOOK TEN Components

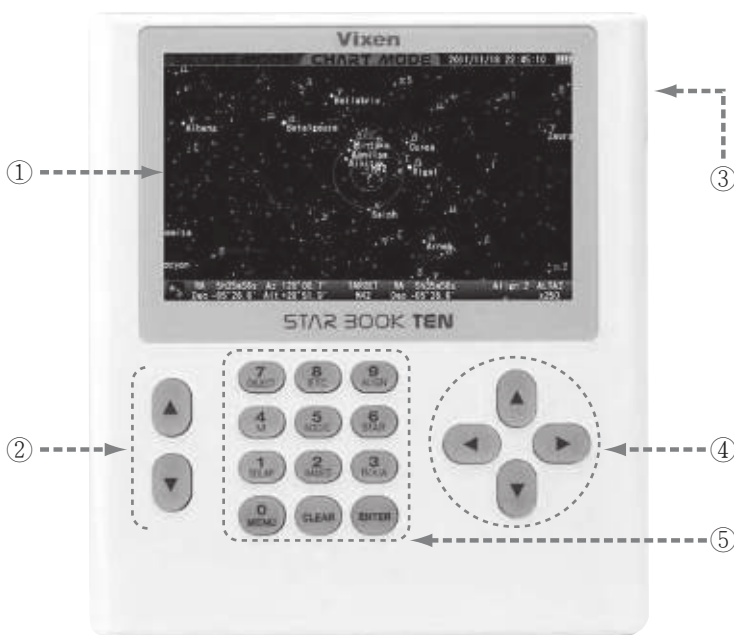

STAR BOOK TEN Bottom View

### ① Color LCD Screen

Displays star charts and information about celestial object and the status of the mount.

### ② Zoom Keys

The zoom keys are used in the following functions.

Enlarge or reduce a displayed star chart on the screen	
	Enlarge a star chart in both Chart Mode and Scope Mode.
	Reduce a star chart in both Chart Mode and Scope Mode.

Scroll the cursor up or down in various menus to change preset values	
	Move the cursor step by step or to have the cursor scroll up every 5 or 6 objects in the Object menu. (It depends on the size of a dialog box.)
	Move the cursor step by step or to have the cursor scroll down every 5 or 6 objects in the Object menu. (It depends on the size of a dialog box.)

Accelerate or decelerate the motor speed between 0.5x and 800x sidereal rate. (The maximum speed can vary according to a set value.)	
	Accelerate the motor speed (Linked to zoom in the screen.)
	Decelerate the motor speed (Linked to zoom out the screen.)

### ③ Power Connecting Port for stand alone use

(DC12V EIAJ RC5320A Class4)

### ④ Direction Keys

Move your telescope manually and scroll the star chart on the screen or move the cursor. (Also the key is referred to as ENTER in some dialog boxes.)

Scrolling star charts	
	The displayed star chart on the screen can be scrolled up and down or back and forth with the  keys if the setting is in AltAz mode. If the direction key setting is in R.A/DEC or X-Y mode, the  keys allow scrolling in the direction of DEC and the  keys allow scrolling in the direction of R.A.
	Move the cursor up and down or back and forth with the  keys.
	Also, : Advance a cursor such as the enter key. (It does not fix the entered value.) : Back to a previous dialog box or screen.

### ⑤ Numerical / Command Keys

Allows you to enter a number or a command indicated on the keys. The following commands are allocated.

Commands	Functions
	*Switches the star chart from Scope Mode to Chart Mode or vice versa. It will proceed to GoTo slewing if pressed in the Chart Mode. *Pressing the key will fix your input value and option.
	Clears menus and/or dialog boxes displayed on the screen and returns to the star chart. (If the key is pressed during the initial settings, the screen will come back to the Initial Configuration menu.)
	Calls up the main menu to perform various setups.
	Chooses a target from the sun, the moon, or planets slew to.
	Chooses a well-known deep sky object like the Andromeda galaxy, the Pleiades star cluster, and so on from the database to slew to it.
	Chooses a mode of the direction keys from AltAzimuth, R.ADecl and X-Y (vertical and horizontal axial movements on the mount).
	Chooses a target from the Messier objects database to slew to.
	Chooses a target from the NGC or IC objects database to slew to. Pressing the key  will switch the database alternately
	Chooses a bright and conspicuous star such as Sirius, Antares, and so on from the database to slew to it for star alignment.
	Displays lists of 272,342 celestial objects.
	Call up the expansion function menu if an optional Advance Unit is installed.
	Aligns your telescope.

### ⑥ Autoguider Port

### ⑦ LAN Connecting Port (10BASE-T)





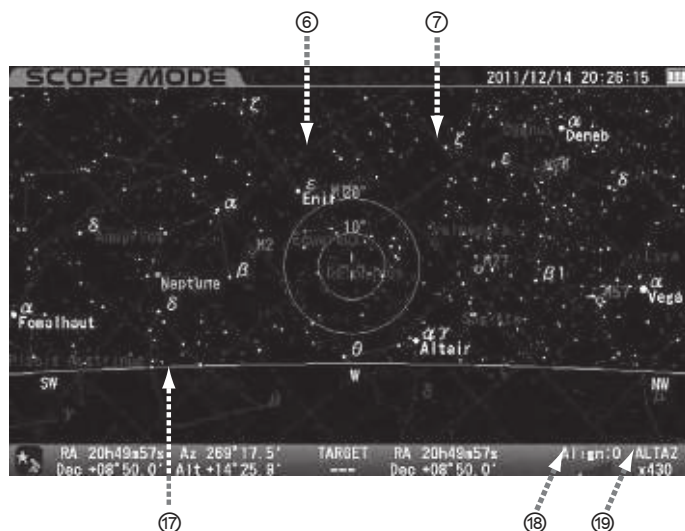
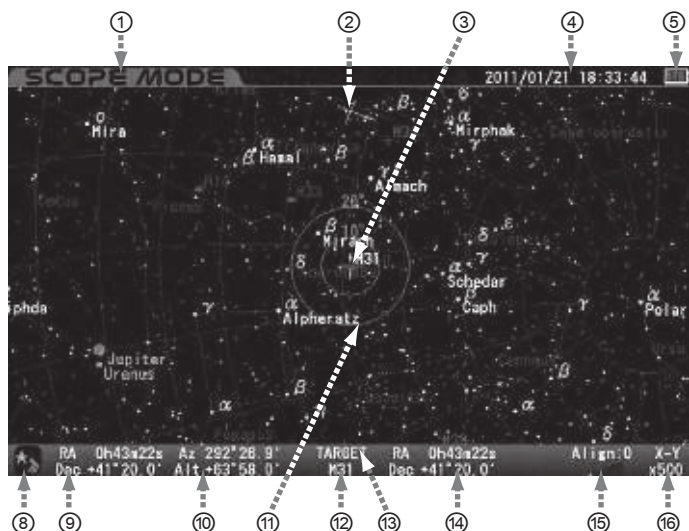

### ⑧ Mount Connecting Port

### ⑨ Expansion Slot for Advance Unit sold separately

















# BEFORE USE

## Screen Menus and Instructions



Item	Description
① Display Mode	SCOPE MODE: The telescope is linked with the star chart. The telescope follows in the same direction as the star chart is scrolled. CHART MODE: The telescope is independent of the star chart. The star chart is scrolled to select a target object.
② Zenith Mark	Indicates the zenith and north-south-east-west directions.
③ Target Object	Indicates the direction where the telescope is pointing or the section of the area where a target is centered. The two concentric circles show areas in an angular field of view.
④ Date	Local time of your observing site.
⑤ Battery Level	Indicates the level of battery discharge if the AC Adapter is not used.
⑥ R.A Grid	Parallel of longitude. 0h to 23h at one-hour intervals.
⑦ DEC Grid	Parallel of latitude. Between -90deg. and +90 deg. at 10° intervals.
⑧ Telescope Icon	Tracking ON / OFF  :ON  :OFF *The counter is displayed while the PEC is in operation.
⑨ Telescope Coordinates	Displays the direction of your telescope in Right Ascension and Declination.
⑩ Azimuth / Altitude	Displays the direction of your telescope in azimuth (left and right) and altitude (up and down).
⑪ Target Circles	Indicates the direction where the telescope is pointing or the section of the area where a target is centered. The two concentric circles show areas in an angular field of view.
⑫ Target Name	Indicates a target by number or its common name (within 10 characters).
⑬ Target	The heading of your target information.
⑭ Target Coordinates	Displays coordinates of the selected target in R.A and DEC
⑮ Zoom Level Indicator	Levels of zooming up or down the star chart by graph.
⑯ Motor Speed	Displays a maximum motor speed at a given zooming rate.
⑰ Horizon	The line corresponds to the horizon.
⑱ Number of Alignment	Number of aligned objects.
⑲ Direction Key Mode	Indicates the orientation of the direction keys     by AltAz, RA DEC or X-Y mode.

Legend \*1

Icon	Object	Icon	Object	Icon	Object
	Galaxy		Moon *3		Uranus
	Diffuse nebula		Mercury		Neptune
	Globular clusters		Venus		Pluto
	Star clusters		Mars		Comet *4
	Planetary nebula		Jupiter		Satellite *5
	Sun		Saturn		

\*1: These icons are different from actual viewing images of the celestial objects. Except the Sun and the Moon, the size of the icons is unchangeable.)

\*2: It is not designed to simulate a transit of a planet on the surface of the Sun and a solar eclipse.

\*3: The appearance of the waxing and waning of the moon displayed on the screen is for illustrative purpose. It is not suitable for accurately simulating an occultation of the moon or a lunar eclipse.

\*4: Register orbital elements of a comet to display.



# BEFORE USE

## Flow of Operation

Take the following steps to set up and use the SXD2 equatorial mount series correctly.

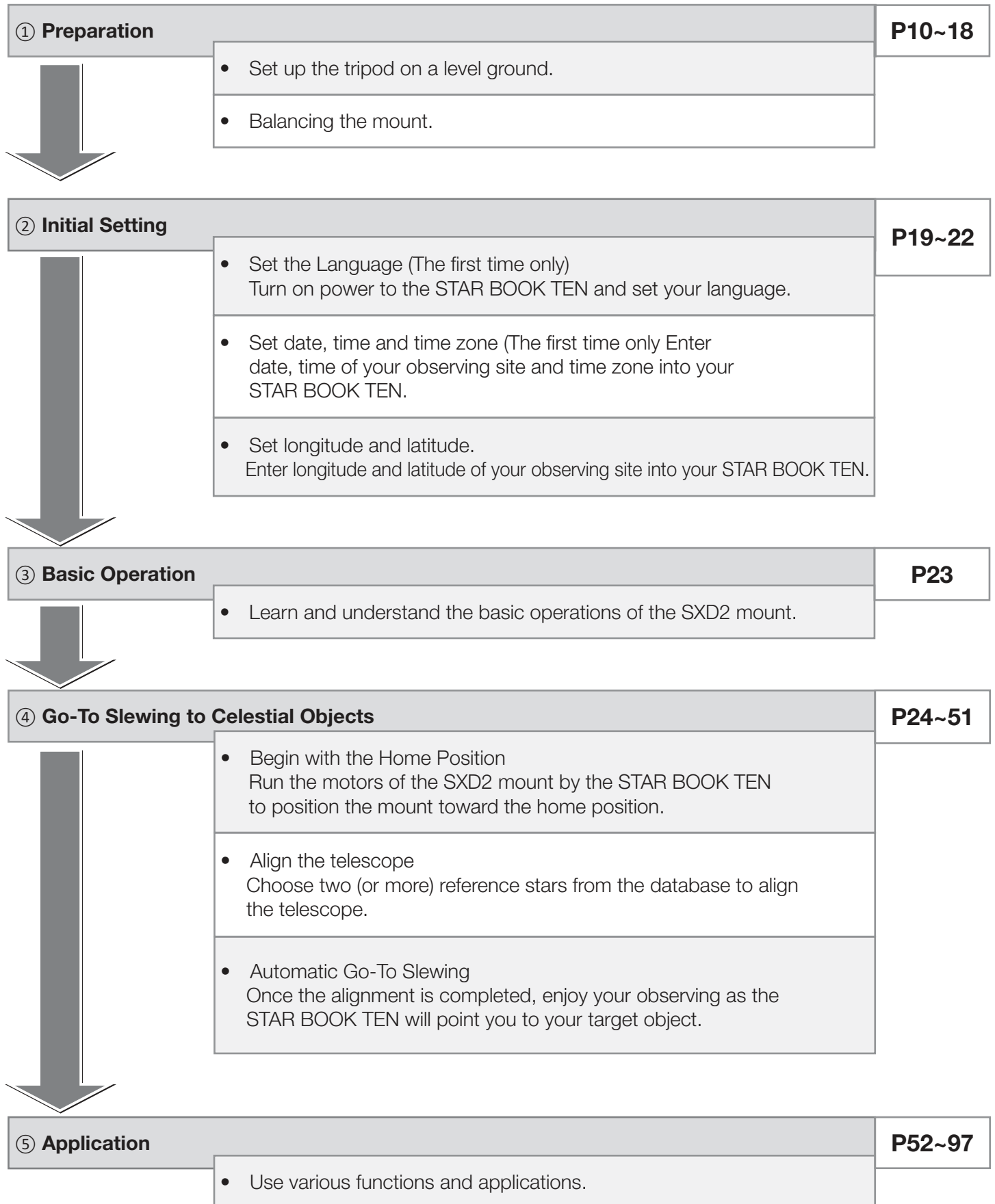

## Chapter 1 PREPARATION

### About the Internal Battery of STAR BOOK TEN

The STAR BOOK TEN controller has a built-in clock, which runs on a CR2032 battery. As the battery is not inserted in the STAR BOOK TEN at Vixen's factory before shipment insert it when you use the STAR BOOK TEN for the first time. The provided battery is for factory inspection and not designed for long term use. (The STAR BOOK TEN is usable even if its internal battery is exhausted, but you will need to set up your local time every time you power on the STAR BOOK TEN.)

### Inserting the Battery

- 1 Remove the cover of the battery container on the back of the STAR BOOK TEN by removing the screws with the provided Phillips screwdriver as shown in the figure.

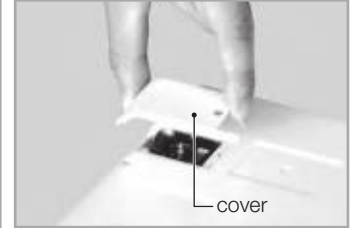
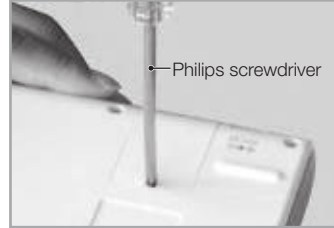

- 2 Insert a fresh battery into the inside of the container so that its positive polarity faces upward. Placing the battery in the wrong direction could result in damage or malfunction.



- 3 Screw the cover back in place.



### Replacing the Battery

- 4 Remove the cover of the battery container on the back of the STAR BOOK TEN.

- 5 Press the edge of the battery with your fingertip and pull up the battery.

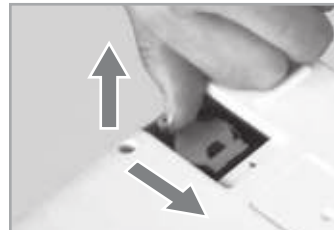

- 6 Push out the battery from the inner side as shown in the figure.



- 7 Insert a fresh battery so that its positive polarity faces upward. Screw the cover back in place.



### CAUTION

Use a wooden stick or an object with non electric conductivity to avoid malfunction or damage to the STAR BOOK TEN when you remove the battery. Do not allow liquids or foreign objects or a finger to enter the battery container. This could result in damage or electrical shock.

## Chapter 1 PREPARATION

### Assembling the Mount

Refer to each instruction manual of your telescope and accessory together with this manual when you attach them to the mount.

#### I. Setting up the Tripod

- 1 Place the tripod on level ground to make the telescope stable during observation. Pull the tripod legs apart until each leg is fully extended.
- 2 Loosen the extension clamp on the tripod leg so that the tripod leg can be adjusted.
- 3 Tighten the extension clamp to hold the tripod leg securely in place.
- 4 Attach the metal post on the tripod head. Thread the metal post into the hole marked as SXD2 and tighten it with a screwdriver.

Tighten the metal post until the end of the thread securely; otherwise it could cause a bending a break.

Position the tripod so that the metal post comes to north.

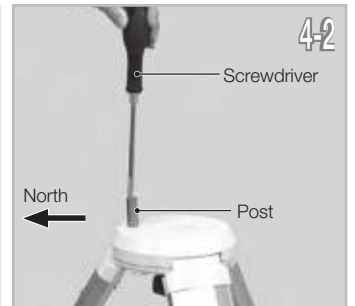
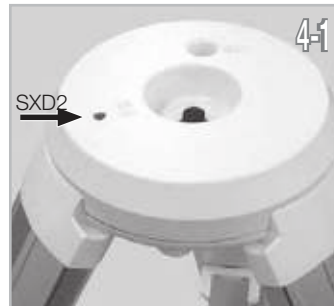
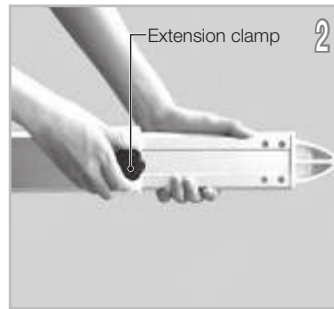

#### Attaching the SXG Half Pillar

Proceed to the step II if this accessory is not provided for your telescope.

- 1 Put the vanity ring on the thread of the metal post and attach the metal post on the head of the half pillar. (1-1)

There are two threaded holes on the head of the half pillar. Thread the metal post into the outer hole and tighten it with the supplied Allen wrench.

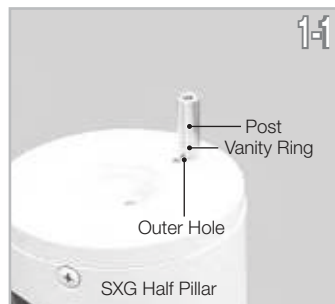

- 2 Loosen the fixing knob on the lower part of the half pillar in advance and put the half pillar on the tripod head. (2-1)

Attach the half pillar on the tripod head so that the center projection on the bottom of the half pillar fits the center hollow on the tripod head. (2-2)

Tighten the lock knob beneath the tripod head to secure the half pillar. (2-3)

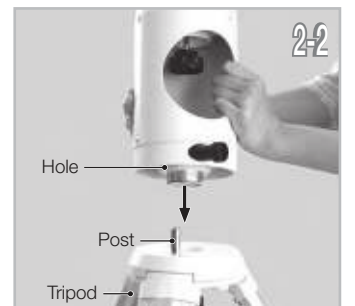
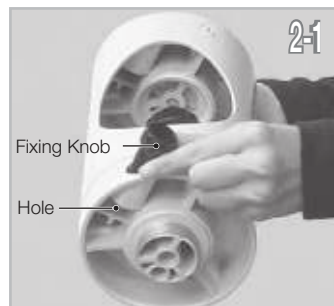

Place the tripod so that the metal post on the SXG Half Pillar faces north.

## Chapter 1 PREPARATION

### II . Attaching the Equatorial Mount

**CAUTION: Be sure to handle the equatorial mount carefully as it is a very heavy item.**

#### Package without the SXG Half Pillar

- 1 Loosen the azimuth adjustment screws in advance by turning the azimuth adjustment knobs on the mount.

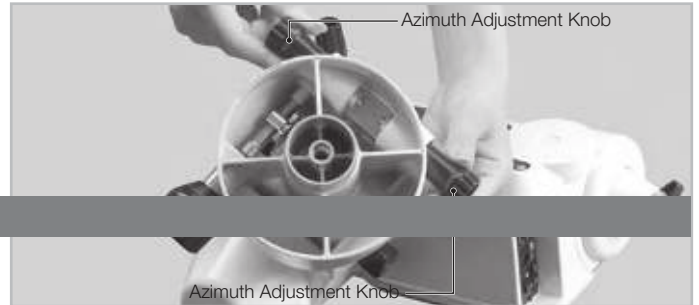

#### Package without the SXG Half Pillar

- 2 Position the mount so that the azimuth adjustment screws of the mounting base come above the metal post as shown in the figure. (2-1)

Place the mount on the tripod and tighten the fixing bolt underneath the tripod head to hold the mount in place. (2-2)

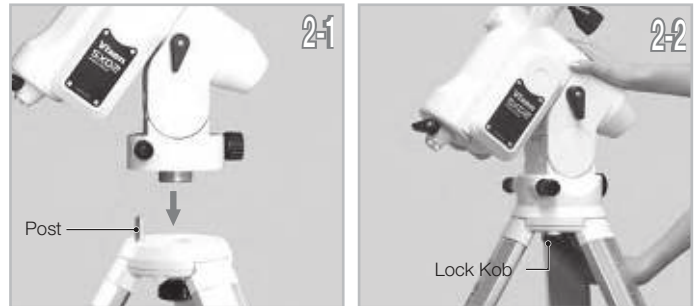

- 3 Tighten the azimuth adjustment screws on the mount base so that the two knobs are set equally.

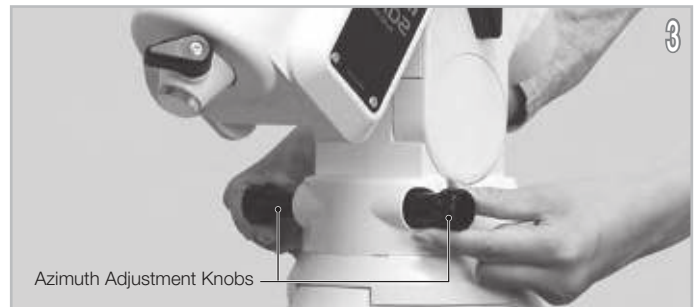

#### Package with the SXG Half Pillar

- 1 Loosen the azimuth adjustment screws in advance by turning the azimuth adjustment knobs on the mount.

- 2 Attach the mount on the half pillar so that the center projection on the bottom of the mount fits the center hollow on the half pillar as shown in the figure. (2-1)

Tighten the fixing bolt underneath the head of the half pillar to hold the mount in place. (2-2)



- 3 Tighten the azimuth adjustment screws on the mount base so that the two knobs are set equally.



## Chapter 1 PREPARATION

### Tips on Assembling the Mount

Generally equatorial mounts are heavier on the declination axis side. Because of this feature, placing the SXD2 mount so that its declination axis comes directly over one of the tripod legs can make it most stable when you use the SXD2 mount for a north (or south) latitude of 50 degrees and lower. However, the balance of the SXD2 mount may vary if it is used in latitude higher than 50 degrees. This may result in shifting the center of balance to the opposite side of the declination axis depending on the location of the loading equipment. Change the position of the tripod legs so that the SXD2 mount becomes more stable in such a case.

### III. Attaching the Counterweight

The counterweight bar is in the declination body. You may balance the SXD2 mount with only the counterweight bar to start.

**CAUTION: Be sure to handle the counterweight carefully as it is a very heavy item.**

- 1 Loosen the counterweight bar lock lever to draw out the counterweight bar.

Tighten the counterweight bar lock lever with the counterweight bar extended fully.



- 2 Remove the safety screw on the end of the counterweight bar. Loosen the lock screw on the side of a counterweight and install the counterweight by sliding it onto the counterweight bar.



- 3 Attach the counterweight so that the lock screw on the counterweight is on the far side of the safety screw as shown in the figure.

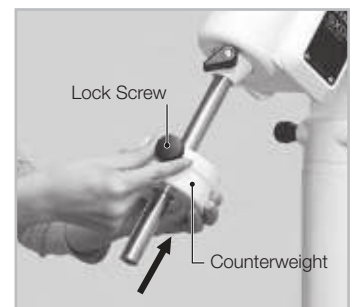
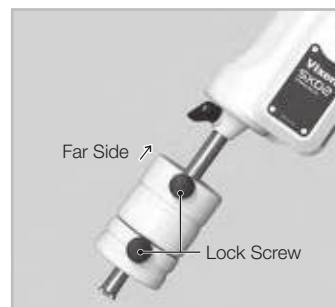

- 4 Tighten the counterweight lock screw and replace the safety screw to screw it down on the end of the counterweight bar tightly.



## Chapter 1 PREPARATION

### IV. Attaching the Optical Tube

Make sure that the slide bar or dovetail tube plate is flat against the saddle plate. Tightening the lock screws with a gap between these parts may cause the telescope to fall.

#### Attaching to the Saddle Plate

- 1 Loosen the two lock knobs on the saddle plate before you attach the optical tube.
- 2 Slide the dovetail bar on the bottom of the optical tube onto the sunken platform of the saddle plate.
- 3 Tighten the two lock knobs on the saddle plate securely.

#### Attaching to the Dovetail-plate Mounting Block

- 1 Loosen the lock knob and the safety screw on the mount head before you attach the optical tube.
- 2 Slide the dovetail tube-plate mounted optical tube onto the sunken platform of the mount head.
- 3 Tighten the lock knob onto the dovetail tube-plate centering notch until snug. Tighten the safety screw securely.

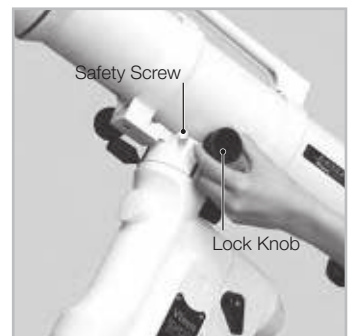
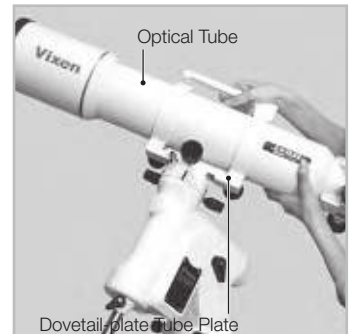
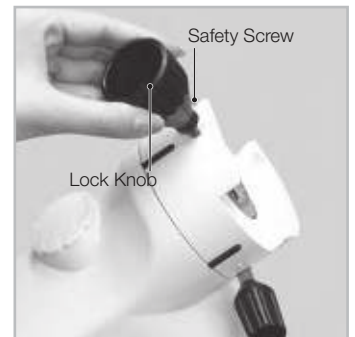

## Chapter 1 PREPARATION

### V . Balancing the Equatorial mount

#### Why Balance the Mount?

The Vixen SXD2 mount is a German equatorial mount, in which the rotating RA axis and rotating DEC axis cross each other at right angle. The axes are rotated by using movements of gears on the each axis to get maximum stability and limit the stress on the gears. If the equatorial mount is in an unbalanced state, it will increase stress to the gears and this could result in damage or erratic operation.

Precise slewing requires a high level of accuracy in rotation of both axes and is important in eliminating stress to the gears. Make sure to balance the equatorial mount properly in RA and DEC accordingly.

An optical tube weighing 1.3kg (2.8 lb.) or less will not balance with the SXD2 mount.

### CAUTION

Take care not to drop the optical tube assembly as it could seriously damage the equipment or lead to injury. Pay close attention to the security of the telescope tube and do not excessively loosen the lock knobs on the equipment.

### Balancing the Mount in Declination

#### Telescope Tube with Dovetail Slide Bar

- 1 Loosen the R.A clamp lever while holding the counterweight bar (1-1) and turn the telescope tube until the DEC axis comes to horizontal (1-2). Tighten the R.A clamp lever and loosen the DEC clamp lever. Be sure to hold the optical tube or counterweight securely while loosening the clamps.

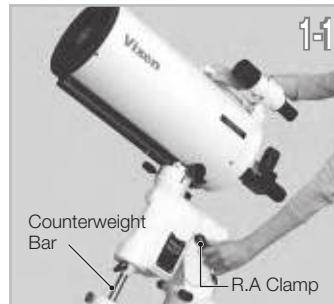

- 2 Release the telescope gradually to see which way the telescope rotates around the declination axis. If the telescope tube starts rotating as you release, it shows there is an imbalance in DEC

To determine the balance point, loosen the lock knob that hold the telescope tube to the dovetail-plate mounting block and slide the telescope tube either forward or backward until it remains stationary.

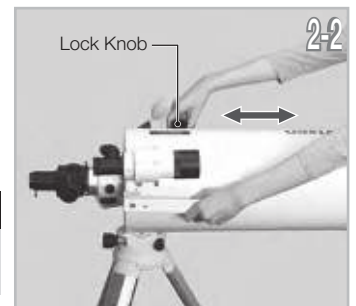

### CAUTION

Do not loosen the lock knob too much in balancing. This could cause the telescope to detach or lead to injury.

- 3 Tighten the lock knob (and the safety screw) securely to hold the telescope tube in place.

- 4 Tighten the DEC clamp to finish this adjustment.

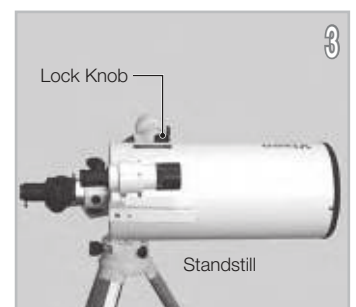

## Chapter 1 PREPARATION

### Telescope Tube with Tube Rings

- 1 Loosen the R.A. clamp while holding the counterweight bar (1-1) and turn the telescope tube until the DEC axis comes to horizontal (1-2). Tighten the R.A. clamp and loosen the DEC clamp. Be sure to hold the optical tube or counterweight in hand while loosening the clamps.

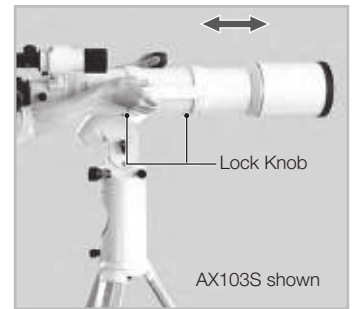

- 2 Release the telescope gradually to see which way the telescope rotates around the declination axis. If the telescope tube starts rotating as you release, it shows there is an imbalance in DEC

To determine the balance point, loosen the tube ring lock knobs that hold the telescope tube and slide the telescope tube either forward or backward until it remains stationary.

### CAUTION

Do not loosen the lock knobs too much in balancing. This could cause the telescope to fall or lead to injury.

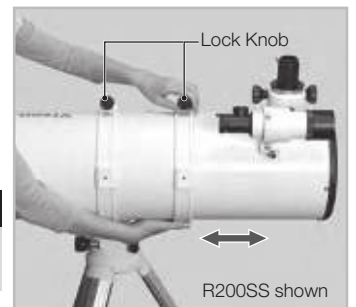

- 3 Tighten the tube ring lock knobs (and the safety screw if any) securely to hold the telescope tube in place.

- 4 Tighten the DEC clamp to finish this adjustment.

### Balancing the Mount in R.A (Right Ascension)

- 1 Loosen the R.A. clamp lever while holding the counterweight bar and turn the telescope tube until the DEC axis comes to horizontal as shown in the figure.

- 2 Release the telescope tube gradually to see which way the telescope rotates around the R.A. axis. If the telescope tube starts moving by its own weight as you release, it shows there is an imbalance in the R.A.

While holding the counterweight bar, loosen the lock knob on the counterweight so that it can be moved to a point where it balances the telescope tube. This is the point at which the telescope remains stationary when the R.A. clamp is loose.

If your telescope is light in weight, the mount may balance without the supplied counterweight. (The extended counterweight bar itself can act as a counterweight.) Retract the counterweight bar for further balance adjustment.

- 3 Tighten the lock knob on the counterweight to hold in place.

- 4 Tighten the R.A. clamp on the mount securely.

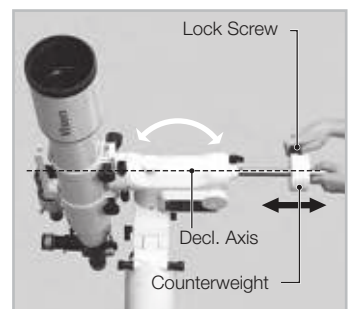

### CAUTION

Do not move the counterweight too much in balancing. This could damage the telescope tube or lead to injury.



# Chapter 1 PREPARATION

## Tips on Proper Balancing

The balance arrangements below illustrate various possible settings, depending on the length and weight of your optical tube. The center of gravity of the telescope is given as 25cm from the intersection of the RA and DEC axes.

### No counterweight:

from 1.3kg (2.8 lbs.) up to 1.8kg (3.9 lbs.)

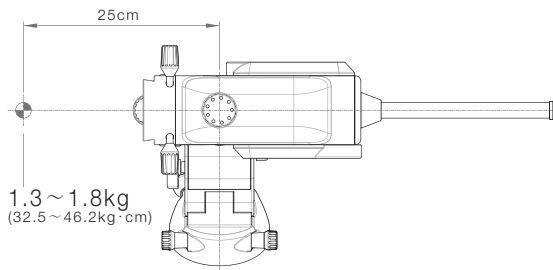

### One 1.0kg (2.2 lbs) only:

from 2.7kg (5.9 lbs) up to 3.5kg (7.7 lbs)

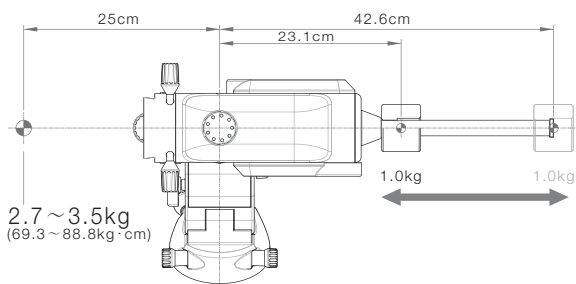

### One 1.9kg (4.1 lbs) only:

from 3.5kg (7.7 lbs) up to 5.0kg (11 lbs)

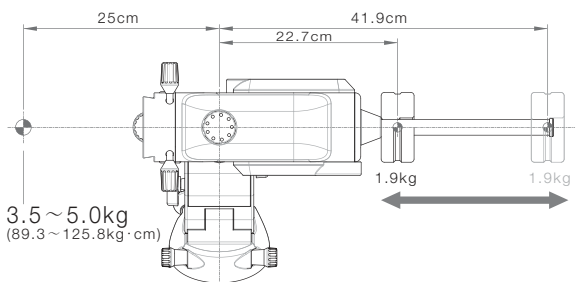

### One 2.8kg (6.1 lbs) only:

from 4.5kg (9.9 lbs) up to 6.6kg (14.5 lbs)

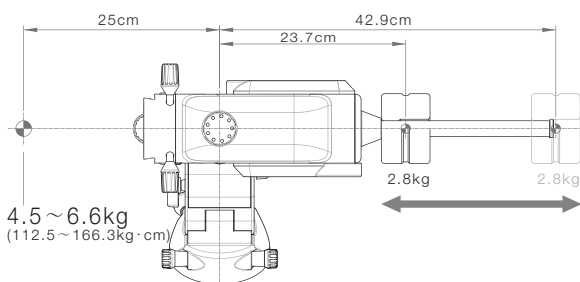

### One 3.7kg (8.1 lbs) only:

from 5.5kg (12.1 lbs) up to 8.3kg (18.2 lbs)

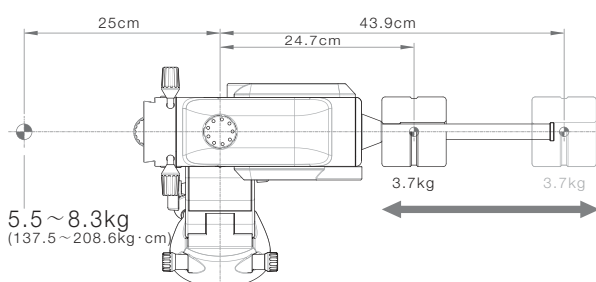

### One 3.7kg (8.1 lb.) and one 1.9kg (4.1 lbs.):

from 7.8kg (17.1 lbs) up to 11.2kg (24.6 lbs)

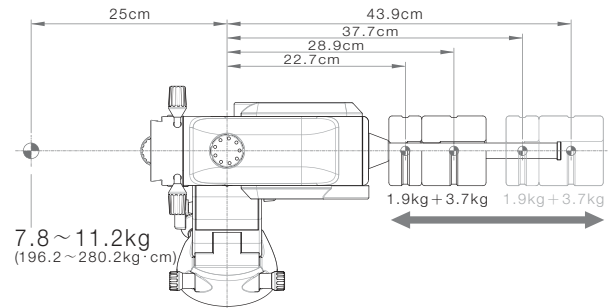

### One 3.7kg (8.1 lbs) and one 2.8kg (6.1 lbs):

from 9.0kg (19.8 lbs) up to 12.4kg (27.3 lbs)

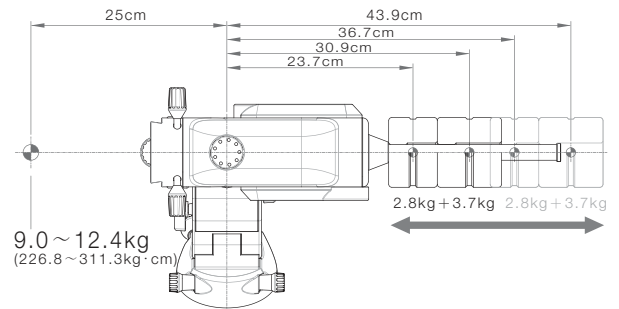

### Two 3.7kg (8.1 lbs):

from 10.3kg (22.6 lbs) up to 14.2kg (31.2 lbs)

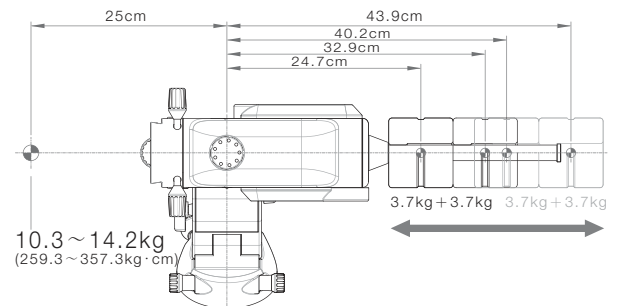

### One each of 1.9kg (4.1 lbs), 2.8kg (6.1 lbs) and 3.7kg (8.1lbs):

from 11.8kg (26 lbs) up to 14.8kg (32.6 lbs)

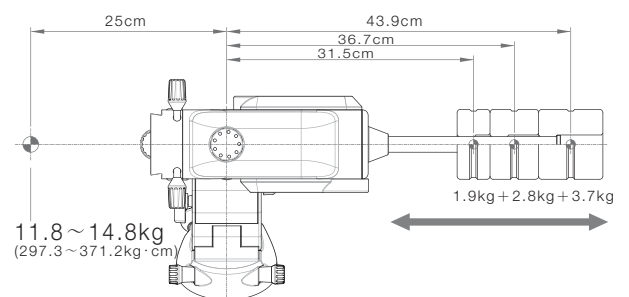

## Chapter 1 PREPARATION

### VI. Connecting the STAR BOOK Cable

#### Connecting to the Mount

- 1 Plug one end of the STAR BOOK cable, where no ferrite core is attached, into the connecting port on the mount for the controller cable.
- 2 Secure the connector with the setscrews.

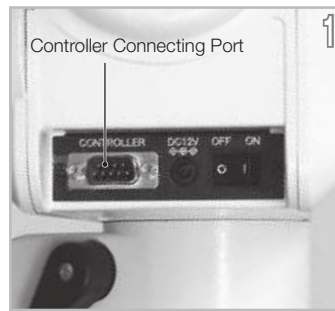

#### Connecting to the STAR BOOK TEN

- 1 Plug the other end of the STAR BOOK cable, where the ferrite core is attached, into the connecting port on the STAR BOOK TEN for the controller cable.
- 2 Secure the connector with the setscrews.



### CAUTION

- \* Hold the connector part of the STAR BOOK cable securely and pull it straight when you unplug the cable. Unplugging by grabbing the cable part may cause a wire to break.
- \* Avoid pulling or bending a part of the cable adjacent to the connectors. It may cause a wire to snap.
- \* Never connect the STAR BOOK cable to other equipment such as a PC. It may cause failure, fire or electrical shock. (The STAR BOOK cable does not meet the RS232C specifications.)

### VII. Connecting the Power Cable

Use an optional AC Adapter 12V-3A or portable power supply with the supplied cigarette-lighter plug cord.  
The portable power supply is sold separately.

Confirm that the power switch is turned OFF (i.e. the O mark on the switch is depressed) before you plug the power cable to the DC12V input of the mount.

Specifications:

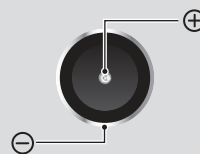

DC12V EIAJ RC5320A  
Class4 center positive (+)



### CAUTION

- \* When you unplug the power cable, be sure to hold the connector part and pull it straight. Unplugging by grabbing the cable part may cause a wire to snap.
- \* Avoid pulling or bending a part of the cable adjacent to the connectors. It may cause a wire to snap.
- \* Do not use the power cable in a folded and tied condition. It may cause electrical shock or fire.

## Chapter 2 INITIAL SETTING

Basic functions of the mount are described in this chapter. For advanced functions refer to Chapter 5 “Application”.

### I . Turning ON the Power

- 1 The power switch is located on the bottom of the declination body of the mount. To turn on the power press the side marked I on the switch and to turn off the power, press the O marked side on the switch.
- 2 Turning on the power switch displays the Vixen logo on the screen of the STAR BOOK TEN.
- 3 The „Initial Configuration“ menu is displayed.



**Note:** Your stored data in the memory may be initialized due to replacement of the built-in battery, firmware version update, or if the built-in battery is exhausted. If this happens: “Memory Error!! Initialized Memory Data” is indicated on the screen and all memory is erased and the STAR BOOK TEN reverts back to default settings.

Note: The mount does not start celestial tracking while the initial setting screen is displayed. The celestial tracking starts at the same time the star chart appears on the screen.

### II . Setting Language

Language is available in Japanese, English, German, Italian and Spanish on the STAR BOOK TEN as of November 2012. The setting is defaulted to „Japanese“.

- 1 In the “Initial Configuration” menu, choose “Language” with the call up ▲ or ▼ direction key and press the (ENTER) key (or the ► key) to the dialog box.
- 2 In the “Language” dialog box, choose “English” with the ▲ or ▼ direction key and press the (ENTER) key.
- 3 Now it is available in English language

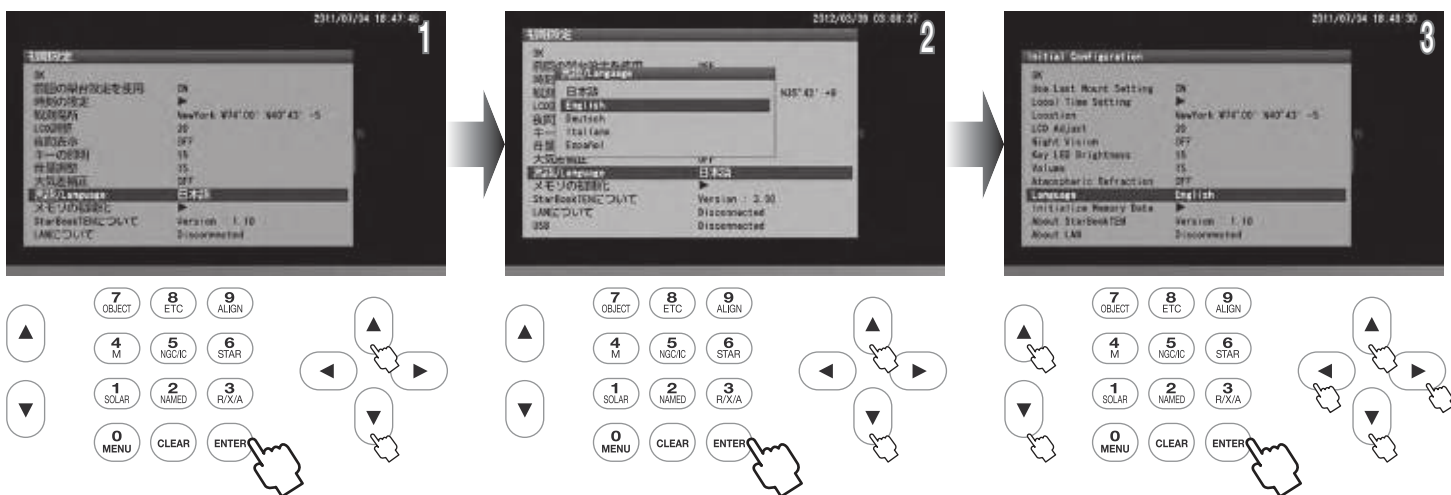

**Note:** You can also access the “Language” dialog box from “System Menu”.

## Chapter 2 INITIAL SETTING

### III . Setting Local Time

This setting is required the first time you use the STAR BOOK TEN or when the internal battery has been changed. You can enter date and local time of your area using 24 hours a clock, i.e. 3pm is 1500. It does not offset daylight saving time. (The last entered date and time information will be stored and displayed.)

- 1 Choose „Local Time Setting“ in the „Initial Configuration“ menu with the  $\uparrow$  or  $\downarrow$  key (zoom key or direction key) and press the  $\text{ENTER}$  (or  $\rightarrow$ ) key to access the „Local Time Setting“ dialog box.
- 2 With the  $\rightarrow$  •  $\leftarrow$  •  $\uparrow$  •  $\downarrow$  direction keys move the cursor to an available entry space and enter the date and your local time with the  $\uparrow$  or  $\downarrow$  direction key.
- 3 Once you fill in the complete time, the cursor shifts to OK. Press the  $\text{ENTER}$  key to complete the local time setting. Then, press the  $\text{ENTER}$  key again to come back to the “Initial Configuration” menu.

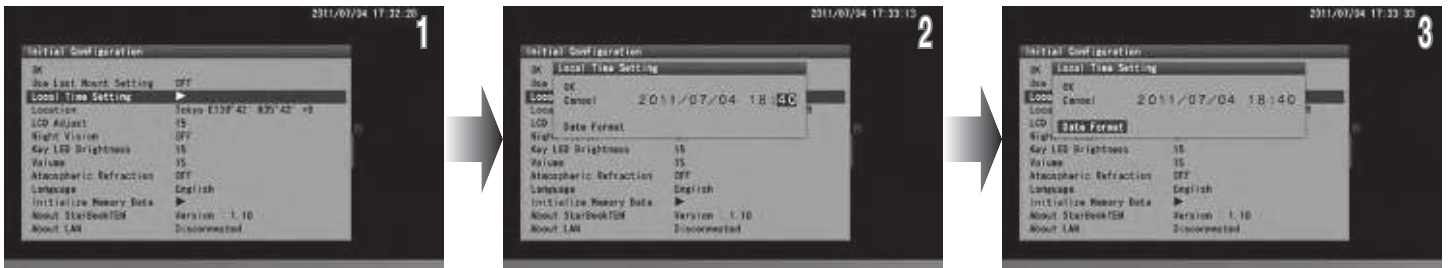

**Note:** You can also set date and your local time by number with the command keys.

#### Example: Enter date of December 21, 2012 and time of 18h05m:

Move the cursor to the entry space for date and time.

$\text{1 SOLAR} \rightarrow \text{2 NAMED} \rightarrow / \rightarrow \text{2 NAMED} \rightarrow \text{1 SOLAR} \rightarrow / \rightarrow \text{1 SOLAR} \rightarrow \text{0 MENU} \rightarrow \text{1 SOLAR} \rightarrow \text{2 NAMED} \rightarrow / \rightarrow \text{1 SOLAR} \rightarrow \text{8 ETC} \rightarrow : \rightarrow \text{0 MENU} \rightarrow \text{5 NGCIC}$  in turn and press the  $\text{ENTER}$  key.

The cursor will move forward automatically as you enter the numbers.

#### Date formats are available from the following 3 patterns:

YY/MM/DD  
MM/DD/YY  
DD/MM/YY

**Note:** You can always access the Local Time Setting from „System Menu“.

Choose “Date Format” in the entry dialog box with the  $\uparrow$  or  $\downarrow$  zoom key (or direction key) and press the  $\uparrow$  or  $\downarrow$  zoom key (or direction key) and press the  $\text{ENTER}$  key to access the Date Format. Move the cursor to your desired date format with the  $\uparrow$  or  $\downarrow$  key and press the  $\text{ENTER}$  key. Then, choose OK with the  $\uparrow$  or  $\downarrow$  key and press the  $\text{ENTER}$  key.

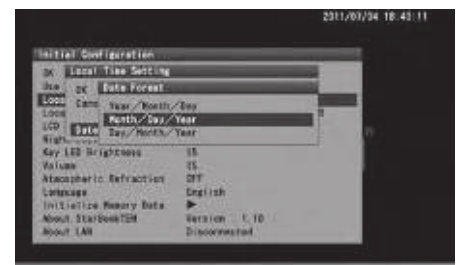

### Time Zone

The time zones are based on longitude bands 15 degrees wide, starting at Greenwich, England. Set the time difference in hours between your local time and Greenwich Mean Time (GMT). The sign is “+” (plus) if local time is ahead of GMT (east of Greenwich) and “-” (minus) if local time is behind GMT (west of Greenwich).

For example, the time zone for Los Angeles (on Pacific Standard Time) is -8 hours.

Please note that the time zone setting is not converted to Daylight Saving time automatically. When you reset your clocks for Daylight time, add one hour to the value in the Time Zone setting, as in Los Angeles, change the setting from -8 to -7.

## Chapter 2 INITIAL SETTING

### IV . Setting Location

This setting is required the first time you use the STAR BOOK TEN or when you change the internal battery or when you travel to a distant observing location.

Enter the name, longitude (east or west), latitude (north or south) and time zone (plus or minus) of your main observing location. Up to 10 different locations can be entered. The longitude and latitude of your observing location can be checked on a map or with a GPS device. The location is defaulted to Tokyo (E139.42, N35.42, TZ+9). (The last entered location information will be stored and displayed.)

#### Enter a New Observing Location

- 1 In the initial setting menu choose "Location" with the  $\uparrow$  or  $\downarrow$  direction key and press the  $\text{ENTER}$  (or  $\rightarrow$ ) key to access the location entry dialog box.
- 2 With the  $\uparrow$  or  $\downarrow$  direction key, move the cursor to an available entry space where no location information is shown. (Tokyo is set as default.)
- 3 Press the  $\text{ENTER}$  key to display the "New Object" dialog box. Enter the name of your observing location by alphabet with the  $\uparrow$  •  $\downarrow$  direction key.

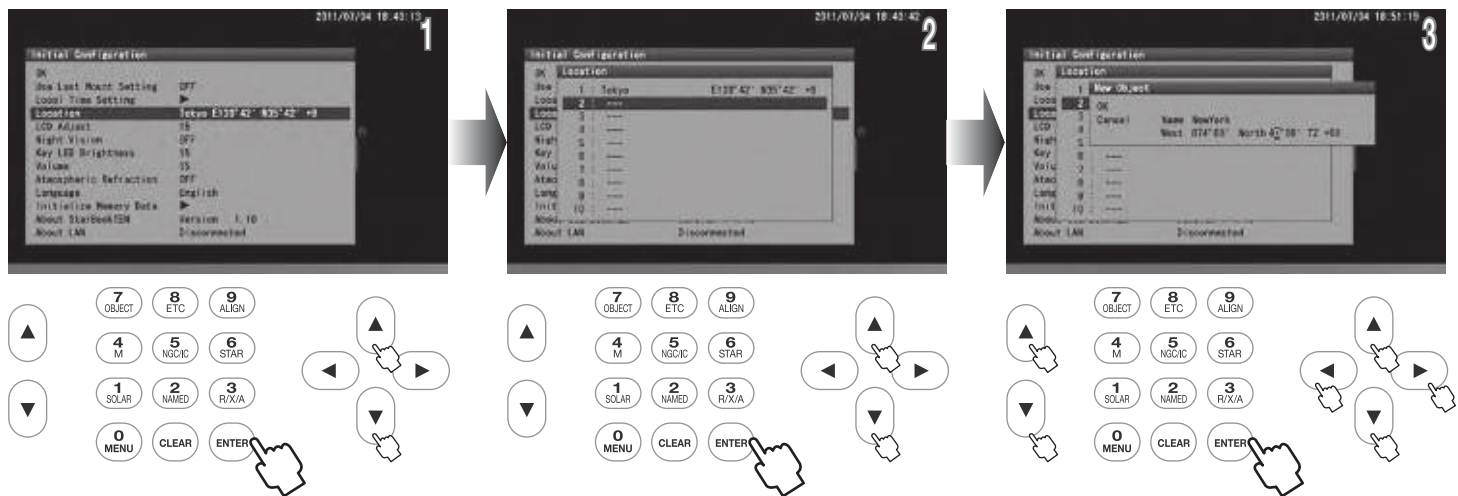

A line of entry spaces accepts a maximum of twenty words

**Note:** Pressing the  $\uparrow$  or  $\downarrow$  zoom key will move the cursor to the next available entry space. (Here, the  $\uparrow$  •  $\downarrow$  direction keys are not allocated for moving the cursor in vertical directions.)

- 4 Enter the longitude, latitude and zone of your observing location in turn with the  $\uparrow$  or  $\downarrow$  direction key or by number directly. Once you fill in the time zone, the cursor shifts to OK.
- 5 Press the  $\text{ENTER}$  key to complete the location setting. Then, press the  $\text{ENTER}$  key twice to come back to the "Initial Configuration" menu to OK.

## Chapter 2 INITIAL SETTING

### Setting, Changing or Deleting the Location Information

1 To use your observing location, move the cursor to „Location“ in the „Initial Configuration“ menu with the  $\uparrow$  or  $\downarrow$  key and press the  $\text{ENTER}$  (or  $\rightarrow$ ) key to access the location entry dialog box.

2 Choose the observing location you want to use from the location information with the  $\uparrow$  or  $\downarrow$  key and press the  $\text{ENTER}$  key. The dialog box appears to confirm your option. Press the  $\text{ENTER}$  key again to set the chosen location.

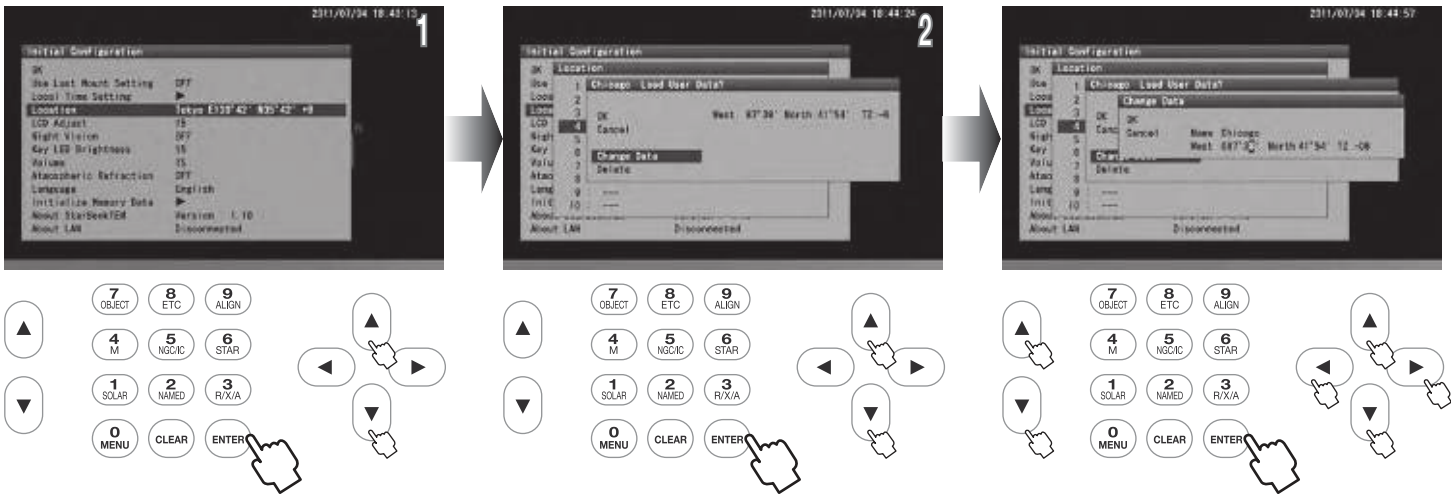

**OK:** Choose OK to set a new observing location you chose.

**Change Data:** Choose "Change Data" to rewrite the observing location.

When you change an observing location in the location information, call up the observing location you want to rewrite in the dialog box and choose "Change Data" with the  $\uparrow$  or  $\downarrow$  direction key. Then, follow instructions for entering a new location as stated above

**Delete:** Choose "Delete" to clear the observing location.

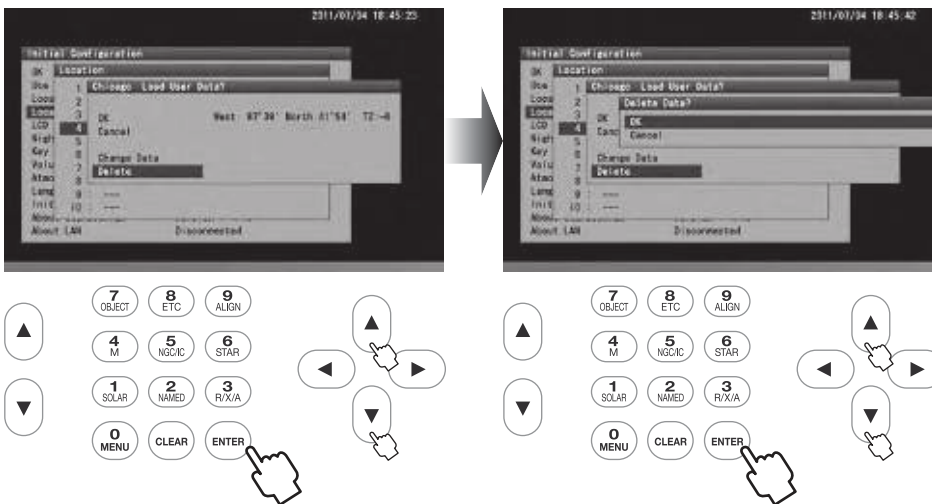

Available letters and characters for the names are as follows:

! " # \$ % & ' ( ) \* + , - . / 0 1 2 3 4 5 6 7 8 9 ; : < = > ? @ A B C D E F G H I J K L M N O P Q R S T U V W X Y Z [ \ ] ^ \_ ` a b c d e f g h i j k l m n o p q r s t u v w x y z { | } ~

## Chapter 3 BASIC OPERATION

### Moving the Telescope

- 1 Make sure that the R.A and DEC clamps on the SXD2 mount are locked tightly.  
Advance the "Initial Configuration" screen in the following procedure to display the telescope's home position setting screen.
- 2 Choose OK with the  $\uparrow$  or  $\downarrow$  key in "Initial Configuration" and press the  $\text{ENTER}$  key to display the "Warning" screen for solar observation.
- 3 Then, choose "Confirm" with the  $\uparrow$  or  $\downarrow$  key and press the  $\text{ENTER}$  key to display the telescope home position setting screen. Pressing the  $\text{MENU}$  key will return the screen to the initial setting menu at this stage.
- 4 Your telescope is ready to slew to all directions as soon as the telescope's home position setting screen is displayed on the screen.

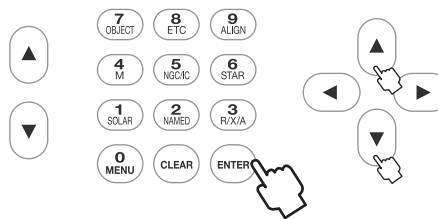
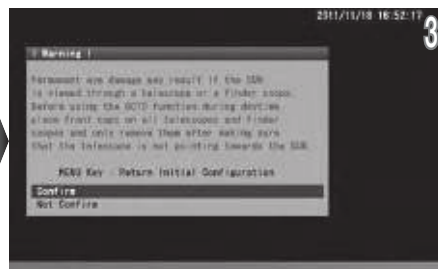
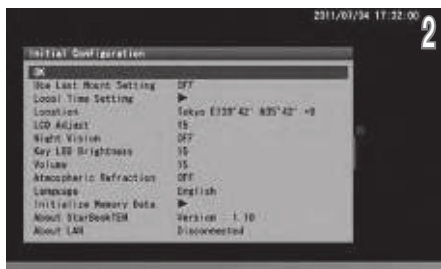

The  $\leftarrow$  and  $\rightarrow$  direction keys move your telescope in the direction of the R.A. The  $\uparrow$  and  $\downarrow$  direction keys on the right side of the STAR BOOK TEN move the telescope in the direction of the DEC.

**Note:** The mount does not start celestial tracking while the initial setting screen is displayed. The celestial tracking starts at the same time the star chart appears on the screen.

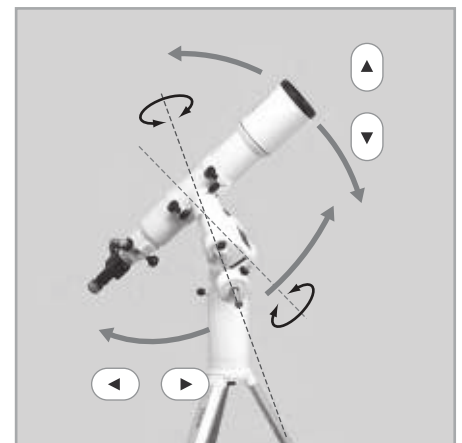

### Changing the Go-To Slewing Speed

You can slew the telescope at different speeds through use of the direction keys.

Default slewing speed: 500x of the sidereal rate at a maximum

Note: If the slewing speed is set at level 3 or below in "System Menu", the maximum available slewing speed is restricted within 400x of the sidereal rate. For using other speed levels, refer to "Mount Setting" section in Chapter 5.

In the telescope's home position setting screen, pressing either of the zoom keys on the left side of the STAR BOOK TEN will quickly vary the maximum slewing speed. The upper key  $\uparrow$  will decrease the motor speed and the lower key  $\downarrow$  will increase the motor speed. These keys are useful in SCOPE MODE when you need a slow motion at high magnification or a quick motion at low magnification.

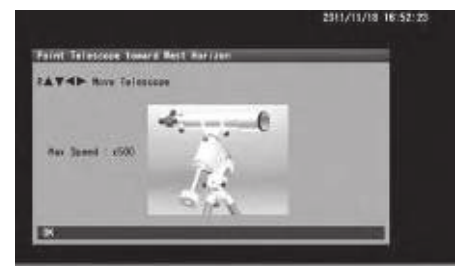

## Chapter 4 AUTOMATIC GOTO SLEWING

### Automatic Go-To Slewing

The moon and bright planets are found readily in the night sky as you can locate their positions with ease. However, less bright planets, nebulae and star clusters are dim and mostly invisible with the unaided eye. Even if you know where these dim and blurred objects are in the night sky, it often takes time and effort to look for them. The automatic Go-To slewing with the STAR BOOK TEN will assist you in locating celestial objects easily and quickly.

### The principle of the automatic Go-To Slewing

It appears that the positions of stars relative to each other in the sky are all but fixed due to their extremely long distances from us on the earth. Because of this, the star's positions on celestial spheres can be measured on star maps using celestial coordinates. The right ascension of the celestial spheres corresponds to latitude and the declination corresponds to altitude on the geographic maps. The STAR BOOK TEN acts as a celestial navigator like your car navigation system.

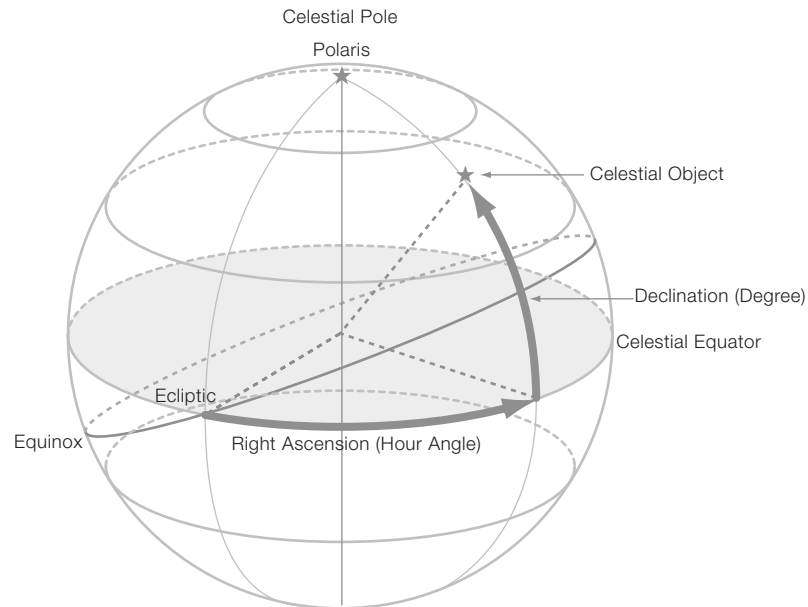

### Startup Procedure

#### Locating the Mount

Point the mount toward the north celestial pole in the northern hemisphere (the south in the southern hemisphere) so that the R.A axis on the mount is parallel with the axis of the celestial sphere in your observing location.

#### Setting Home Position

Loosen the clams on the R.A and declination axes and move the telescope to the home position by hand. Point the optical tube to due west horizon in the northern hemisphere (due east horizon in the southern hemisphere) to fix the home position.

#### Two Star Alignment

Select two stars from the list in the STAR BOOK TEN to align the telescope. The more alignment stars you select, the more centrally located the target objects will be in your telescope's field of view.

#### Automatic GOTO slewing

Choose your target on the screen of the star chart or from the database of extensive celestial objects in the menu and slew the telescope to your target. Enjoy your observing!



## Chapter 4 AUTOMATIC GOTO SLEWING

### I . Locating the SXD2 Mount

After setting up the telescope, locate the SXD2 mount so that its R.A axis points toward the north celestial pole if you use the telescope in the northern hemisphere. If your intention is not to take lengthy astrophotography, you don't need to align the R.A axis to the celestial pole precisely. A rough setting will work well for visual observation. While looking for the polar star, locate the mount so that it faces toward the north and the elevation of the R.A axis matches the latitude of your observing site.

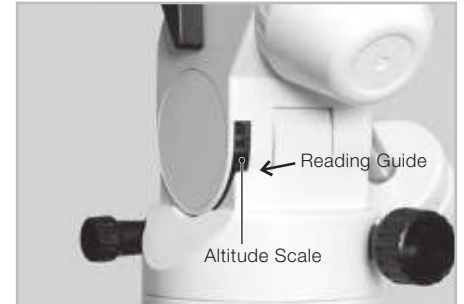
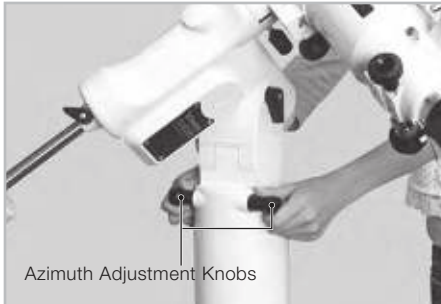

- Loosening the adjustment screw on one side will allow you to tighten the screw on the other side to change the altitude and azimuth directions.
- If you use the telescope in the southern hemisphere, locate the SXD2 mount so that the R.A axis points toward the south celestial pole and set the elevation of the mount to be equal to the latitude of your observing site.

### II . Home Position

- 1 Flipping on the power switch on the bottom of the declination body of the SXD2 mount will turn on the STAR BOOK TEN. Complete all the initial settings such as time and location. Advance the screen on the STAR BOOK TEN until the image shown on the right appears on it. Use an eyepiece with magnification as low as possible.

Note: If the star chart is already displayed on the screen, turn off the power switch and reboot the STAR BOOK TEN to start from the initial setup screen

- 2 In the "Initial Configuration" menu, choose OK with the  $\uparrow$  or  $\downarrow$  key and press the **ENTER** key. The "Solar Warning" notice appears on the screen. Choose "Confirm" with the  $\uparrow$  or  $\downarrow$  key and press the **ENTER** key to advance.

The home position setting appears on the screen and the mount is now ready to move in all directions using the the  $\rightarrow$  •  $\leftarrow$  •  $\uparrow$  •  $\downarrow$  direction keys. The mount does not start tracking at the celestial rate during this stage.



- 3 Loosen the R.A and Declination lock clamps on the mount and position the telescope's optical tube so that it points toward the west and is level. Refer to the image of the telescope displayed on the screen to understand it correctly. When you fix the position of the optical tube, tighten the R.A and declination lock clamps on the mount. After this, do not touch the lock clamps until you finish your observing. The home position is the first positioning of your telescope to determine. Set the home position by measuring with your eye as close as possible.

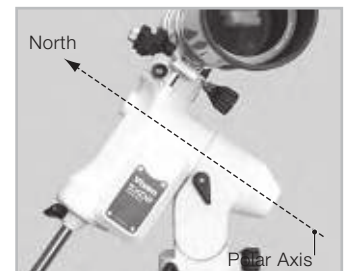
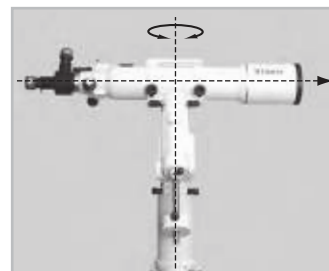

### About Home Position Guideposts

The SXD2 mount has guideposts on the R.A and Declination individually. The guideposts are useful when you position the telescope tube to be level toward west in the northern hemisphere (toward east in the southern hemisphere).

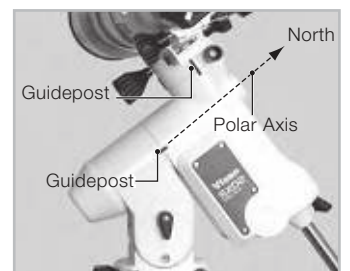
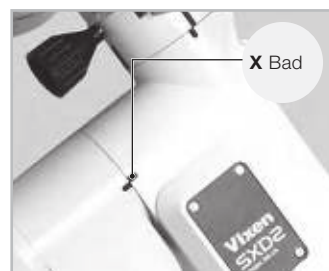

## Chapter 4 AUTOMATIC GOTO SLEWING

### III. Alignment

- 1 After determining the home position of your telescope, press the **ENTER** key to display the interactive dialog box on the screen. The dialog box asks you if you enter SCOPE MODE. Choose OK with the **▲** or **▼** key and press the **ENTER** key.



- 2 The star chart in SCOPE MODE appears on the screen. The concentric target circles in the center of the star chart indicate due west. (The target circles indicate due east in the southern hemisphere.)

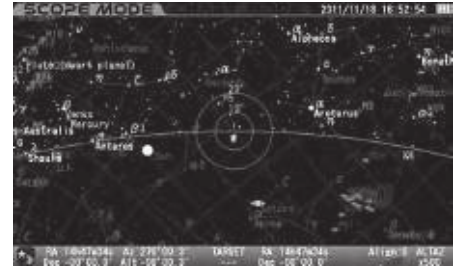

The SXD2 mount starts tracking at the celestial rate from that point and now the Go-To slewing will accurately bring a target object in the finder scope's field of view. You need to proceed to star alignment to set the pointing accuracy of your telescope.

After this, CHART MODE and SCOPE MODE will switch over each time you press the **ENTER** key while the star chart is displayed on the screen. Its status is displayed at the upper left on the screen. Pressing the **ENTER** key in CHART MODE will ask you to proceed to the Go-To slewing.

#### What is Star Alignment?

The star alignment matches celestial coordinates of stars memorized as location information in the STAR BOOK TEN with positions of stars that can be really seen in the sky. The location information is identified with a star and this pairing is called "getting an alignment point".

CHART MODE and SCOPE MODE can switch over each time you press the **ENTER** key.

#### What is SCOPE MODE?

SCOPE MODE is linked with the movements of your telescope. The top and bottom of the screen are highlighted in red in SCOPE MODE. The telescope follows the target circles on the starscreen as you scroll the star chart with the **▶◀●▲▼** direction keys in SCOPE MODE. The Go-To slewing is simple with the command keys.

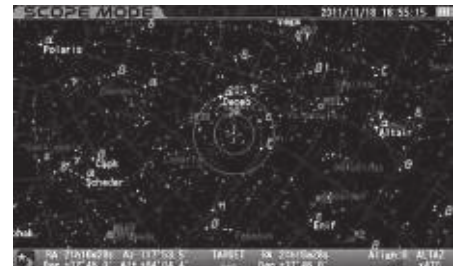

#### What is CHART MODE?

CHART MODE is independent from the movements of your telescope. The top and bottom of the screen are highlighted in blue in CHART MODE. With no linkage to the telescope, scrolling of the chart is quick and easy with the **▶◀●▲▼** direction keys. Go-To slewing is readily available with the command keys. Additionally, you can look for a target directly on the star chart in this mode.

The screen will turn to SCOPE MODE as soon as the telescope gets to the target.



## Chapter 4 AUTOMATIC GOTO SLEWING

3 Select a star from an alignment stars list in the object database. Be sure to select alignment stars for which you recognize locations in the night sky. Aldebaran in Taurus, the Bull is shown here as an example of the first alignment star.

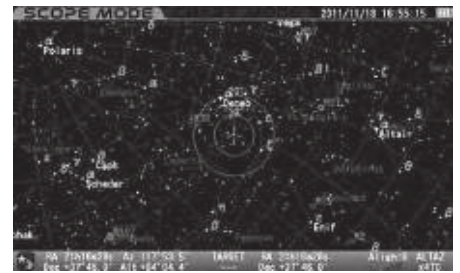

In SCOPE MODE, press the **6 STAR** command key (or the **7 OBJECT** command key to access "Star" in "Object Menu" with the **▲** or **▼** key, and press the **ENTER** key).

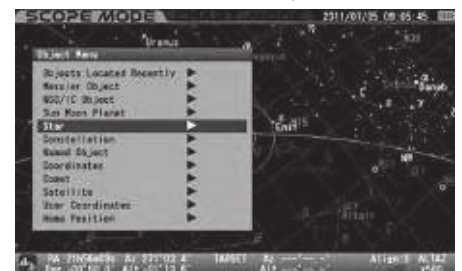

Select stars that are available for alignment (stars marked with © are seen above the horizon.) with the **▲** or **▼** direction key and press the **ENTER** key.



The dialog box appears to confirm if you are ready to slew the telescope to the target you selected. Choose OK and press the **ENTER** key to start the Go-To slewing. At the same time, the target is marked and a position of the first alignment star is indicated on the bottom of the screen by its coordinate.

**Note: If the "Go-To message" is set to off, the Go-To slewing will start at once without confirmation. This chapter assumes that the "Go-To message" is set to on.**



The telescope starts moving toward the target. (Go-To is indicated on the lower right of the screen.)

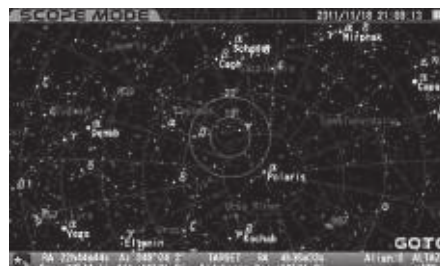

Go-To slewing is completed.

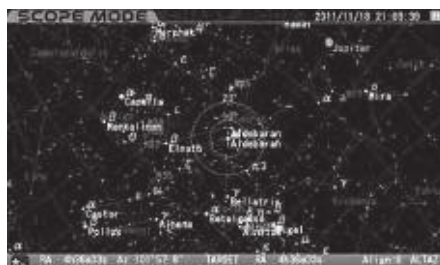

As soon as the Go-To slewing finishes, the STAR BOOK TEN rings the chimes and the slewing speed is changed to the sidereal rate.

## Chapter 4 AUTOMATIC GOTO SLEWING

4 Your first Go-To slewing may not bring the alignment star in the main telescope's field of view but should appear in the finder scope.

Here, center Aldebaran in the telescope's field of view as an example with the following procedure.



Move the telescope with the  direction keys so that you bring Aldebaran to the center of the finder scope's field of view. Magnifying the star chart with the zoom key will slow the motion of the telescope and thus allow you to make finer adjustments of the position.

Bring Aldebaran in the center of the finder scope's field of view and look for it in the telescope's field of view.

**Note:** Aldebaran will be away from the center of the target circles on the screen as you move the telescope to look for Aldebaran in the field of view of the telescope. This is caused by a difference between the actual position of Aldebaran viewed and the location of the same star in the database of the STAR BOOK TEN. It is a normal behavior. In this stage of the star alignment, the telescope's field of view corresponds to a correct orientation of the telescope and disregards the position of the target on the screen.

After you place the target in the finder scope's field of view, use an eyepiece with low magnification (A larger number eyepiece in millimeters such as a NLV20mm) to bring it in the field of view of the main telescope. Then, change to an eyepiece with high magnification (A smaller number eyepiece in millimeters such as a NLV5mm) so that you can center the target accurately.

Press the  key on the STAR BOOK TEN as you have centered Aldebaran in the field of view of the telescope successfully.

The dialog box appears to confirm the star alignment with Aldebaran. Choose OK with the  or  key, and press the  key.

The first star alignment has been completed. The target Aldebaran comes to the center cross of the target circles on the screen.

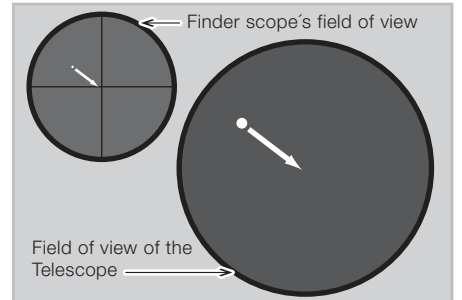
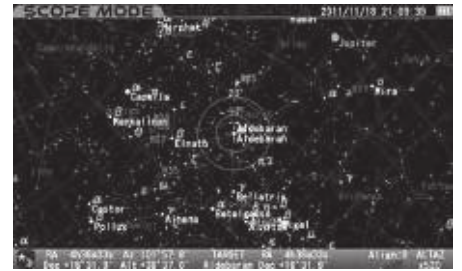

5 Proceed to the second star alignment with a different star to increase the pointing accuracy of the telescope. The more star alignments you have, the better your targets are centered. (You can perform a maximum 20 alignment points.)

## Chapter 4 AUTOMATIC GOTO SLEWING

### Slewing the Telescope to an Object near the Sun or to the Sun

If you try slewing to an object near the Sun or to the Sun, the STAR BOOK TEN will alert you with a dialog box: "Warning! Target is close to the Sun." In the dialog box, choose OK with the  $\uparrow$  or  $\downarrow$  key and press the  $\text{ENTER}$  key to advance

### CAUTION

When slewing to the object near the Sun, be careful not to have the Sun traverse the field of view of your telescope. Never look directly at the sun with your naked eyes or through the telescope. Permanent and irreversible eye damage may result. Make sure that the finder scope is covered with the objective cap.



### Stop the Slewing Quickly

The movements of the telescope will pause if you press any of the keys (except the zoom keys) during the Go-To slewing. Use this option stop the telescope quickly if the optical tube is about to hit something or if you want to cancel the ongoing slewing.

At the same time, the dialog box appears to confirm to continue the Go-To slewing. Choose OK or Cancel with the  $\uparrow$  or  $\downarrow$  key, and press the  $\text{ENTER}$  key. Pressing OK will continue the slewing again. Pressing Cancel will stop the slewing on the spot. Then, the target will be cleared.

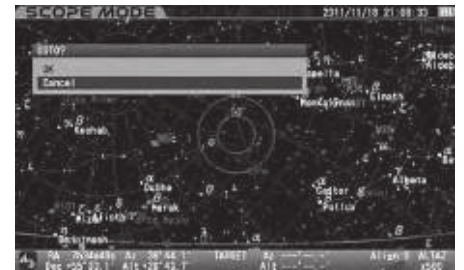

### Changing the Display Mode

Pressing the  $\text{ENTER}$  key a little longer will switch between CHART MODE and SCOPE MODE alternately. In CHARTMODE, pressing the  $\text{ENTER}$  key a little longer will make the star chart screen key change to SCOPE MODE and vice versa.

## Chapter 4 AUTOMATIC GOTO SLEWING

### Tips on Star Alignment

- It is advisable to use fixed stars for the alignments. As the distant stars are a fixed point of light and they have no area, you can pinpoint a location for an alignment point. Alignments with the moon, planets, nebulae and star cluster are not as accurate as star alignment with fixed stars.

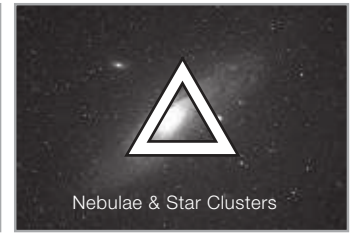
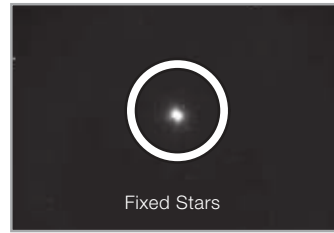

- Choosing several alignment stars which are separated over 10 degrees to other will increase the pointing accuracy of your Go-To slewing. Twenty points are available for the alignment.
- The dialog box on the right appears if the selected star for the alignment is located within 10 degrees from the previously aligned stars. If you choose OK, the aligned star less than 10 degrees apart will be deleted and replaced with the latest aligned star. Choose Cancel if you stop the alignment.



- The dialog box on the right appears if the star alignment is being done with the same star again. If you choose OK, the star alignment will be overwritten by new one. Choose Cancel if you stop the alignment.



- If the pointing accuracy of your telescope has not been improved, delete all the alignment stars and align the telescope from the beginning.
- Using stars adjacent to the celestial poles for the star alignment may not contribute to improving the pointing accuracy of your telescope.
- Using stars near the horizon for the star alignment may result in disturbing the pointing accuracy of your telescope as it is affected by atmospheric conditions.
- Choosing stars from the menu makes your star alignment more accurate than choosing stars from the star chart in CHART MODE.
- If the target is not chosen, alignment will not work.



- Each position of the aligned stars is defined by altitude and azimuth based on a point in time you aligned. Every alignment star moves toward the west due to the diurnal motion. As a consequence, if the aligned stars move more than 10 degrees (more than 40 minutes in time), the STAR BOOK TEN will accept the same star for alignment. This is a normal behavior.
- Calculations for star alignment are based on the most reliable two points among the alignment stars

# Chapter 4 AUTOMATIC GOTO SLEWING

## IV. Slewing to an Object in SCOPE MODE

Once the star alignment is completed in Section III, choose a celestial object to which you want to slew. You can look for objects like nebulae and star clusters on the star charts of the STAR BOOK TEN to choose what you want to observe. Here, the Great Nebula, M42 in Orion, the Hunter is shown as a target.

- 1 Press the **4 M** key to access the „Messier Object“ database.
- 2 Select M42 with the **▲** or **▼** direction key. Or, enter directly 4→2 in succession. \*1 \*2 \*3

\*1: Objects marked with © are available for observing. If you choose an object with no © mark, the message “Unable to GO below horizon!” is displayed as shown below. Information about the object follows but you cannot slew to it.

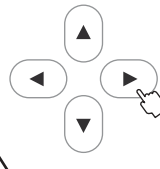
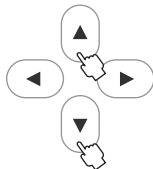
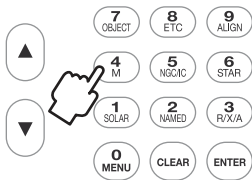
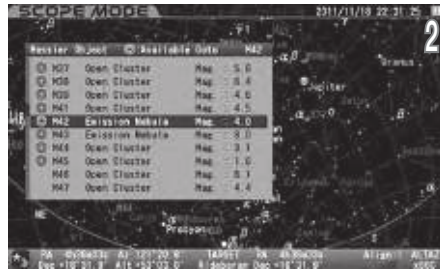
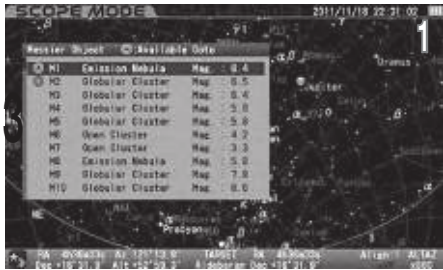

- \*2: Using the **▲** or **▼** zoom key will shift the cursor on the screen with every five lines.
- \*3: The numerical keys allow to enter directly by number.

- 3 Press either the **ENTER** key or the **▶** direction key to advance the screen. The dialog box appears, and confirms to proceed to the Go-To slewing. Press the **ENTER** key to start.

To stop, shift the cursor to Cancel with the **▲** or **▼** direction key and press the **ENTER** (or **◀**) key. The dialog box disappears and you are ready to choose another.

If you discontinue the Go-To slewing, press the **CLEAR** key.



The telescope starts moving toward the target.

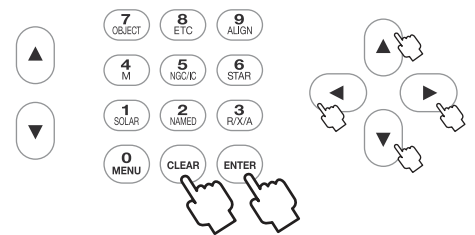
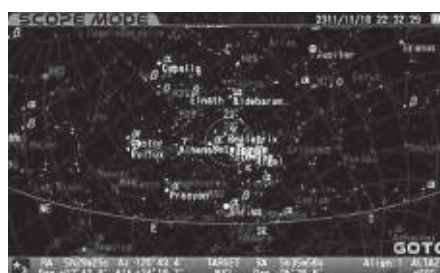

The telescope arrives at the target.

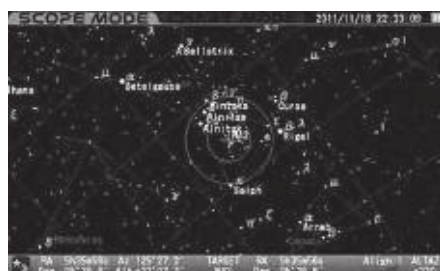

The Go-To slewing finishes with ringing the chimes.

# Chapter 4 AUTOMATIC GOTO SLEWING

## V . Slewing to an Object in CHART MODE

The Go-To slewing in CHART MODE works in the same way as you did in SCOPE MODE. Additionally, scrolling the star chart allows you to select any object as a target and automatically slew your telescope to it. Here, the Great Nebula, M42 in Orion, the Hunter is shown as a target.

Make sure the star chart is displayed in CHART MODE. If in SCOPE MODE, press the **ENTER** key to switch over the screen to CHART MODE. The screen will be highlighted in blue at its top and bottom portions.

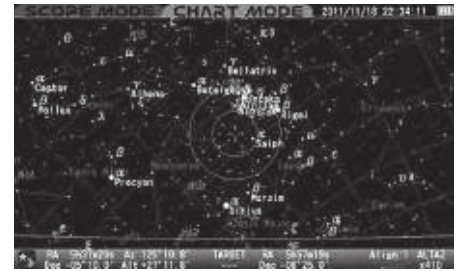

**1** Scroll the star chart with the **▲** **▼** **▶** **◀** direction keys so that M42 comes near to the center in the target circles. Using the **▲** or **▼** zoom key at the same time will quickly facilitate this process.

**2** Zooming in the star chart allows you to make slower movements of the star chart with the **▲** **▼** **▶** **◀** direction keys. Place M42 within the target circles. Then, bring it to the center and press the **ENTER** key.

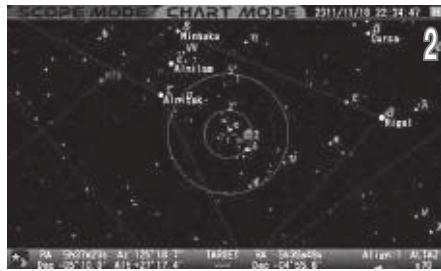
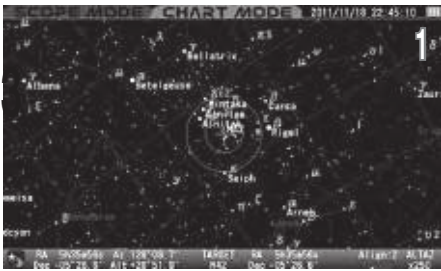

**3** The dialog box will appear and confirm that you want Go-To slewing

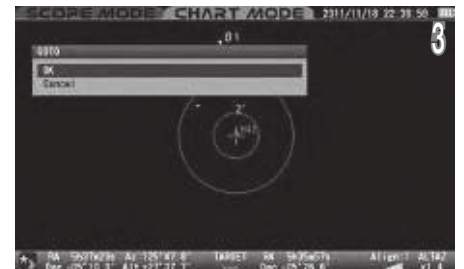

**Note:** The dialog box will not appear on the screen if the "Go-To Message" is set to off. In this case, the Go-To slewing starts at once.





## Chapter 4 AUTOMATIC GOTO SLEWING

4 The Go-To slewing finishes with ringing the chimes. Pressing the **ENTER** key will start slewing the telescope to the target.



When you call up M42 from "Object Menu" in CHART MODE, the interactive dialog appears on the screen. Choose OK and then press the **ENTER** key, M42 will appear in the center of the star chart as the target.



If you choose Cancel with the **▲**/**▼** or direction key and then press the **ENTER** key, the Go-To slewing will be discontinued. At the same time the screen changes to SCOPE MODE and shows the area of the star chart where the telescope is pointing on its way to the target.

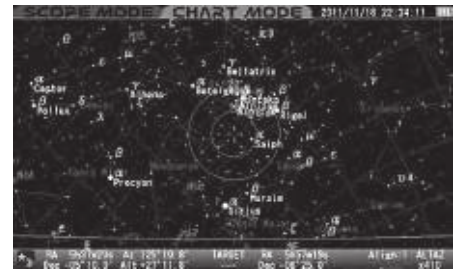

# Chapter 4 AUTOMATIC GOTO SLEWING

## VI. Slewing to an Object with Command Keys

The STAR BOOK TEN has command keys to allow direct access to each list of celestial objects in the database.

**1 SOLAR** This choice displays a list of planets in the solar system (Mercury, Venus, Mars, Jupiter, Saturn, Uranus, Neptune and a dwarf-planet Pluto) as well as the sun and moon.

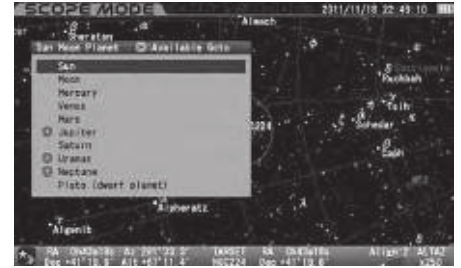

**2 NAMED** This displays a compiled list of well-known nebulae, star clusters and deep-sky galaxies.

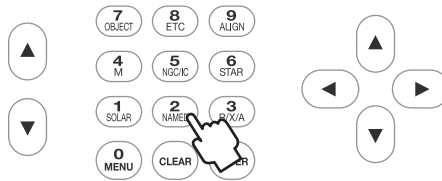

**4 M** Catalogs This displays a complete list of Messier objects.



**5 NGC/IC** This displays a complete list of objects in the NGC and IC catalogs. Refer to an example of using the NGC/IC key on page 42.

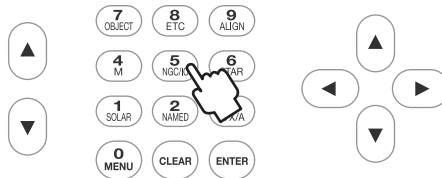

**6 STAR** This displays a compiled list of bright and named fixed stars from the SAO catalog.



# Chapter 4 AUTOMATIC GOTO SLEWING

## Moon Map

The "Moon Map" dialog box appears on the screen if you press the **1 SOLAR** key a little longer. The telescope can be pointed at the major "seas" and geographical formations on the surface of the moon.

- Note:**
- The moon is displayed based on a simplified description of the age and map of the moon, but the moon seen on the screen may differ slightly from the real one.
  - The moon is relatively a very shining object and it may be so bright that your eye will tire with long observation. Therefore, it is advisable to use a moon filter and the like for observing to reduce the brightness.

### Calling up the Moon Map directly

**1** Instant Display of the Moon Map: The "Moon Map" dialog box appears on the screen if you press the **1 SOLAR** key a little longer in both SCOPE MODE and CHART MODE.

**2** The "GOTO" dialog box will appear if the screen is in SCOPE MODE. The dialog box is displayed regardless of the setting of "GOTO Message". Choose OK and press the **ENTER** key to start the automatic Go-To slewing. The "Moon Map" dialog box appears on the screen when the automatic slewing is completed. Be aware of the motion of your telescope.

To leave the dialog box, choose CANCEL with the **▲** or **▼** direction keys and press the **ENTER** key, or pressing either the **◀** direction key or the **CLEAR** key to return to the previous screen.

If you use CHART MODE on the screen, the "SELECT?" dialog box will be displayed. Choose OK and press the **ENTER** key to advance. The "Moon Map" dialog box appears.

To leave the dialog box, choose CANCEL with the **▲** or **▼** direction key and press the **ENTER** key, or press either the **◀** direction key or the **CLEAR** key to return to the previous screen.

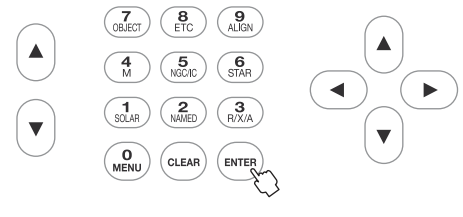
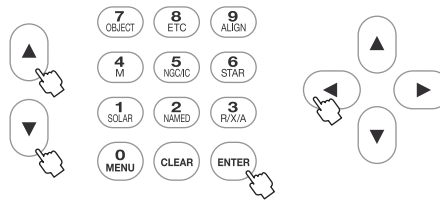
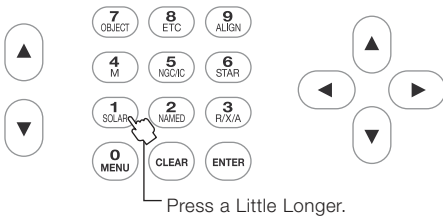
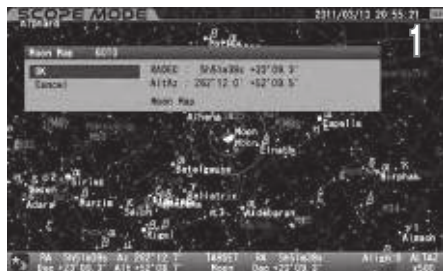

### Calling up the Moon Map from „Object Menu“

**1** Before you begin, confirm that the "GOTO Message" is set to ON with the use of SCOPE MODE. Press the **7 OBJECT** key to call up the "Object Menu".

**2** Select "Sun Moon Planet" from the list with the **▲** or **▼** direction keys and press the **ENTER** (or the **▶**) key to move down to the subsidiary dialog box.

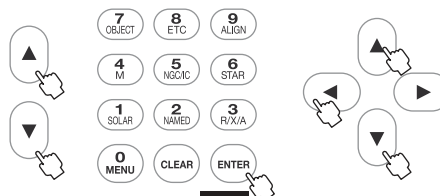
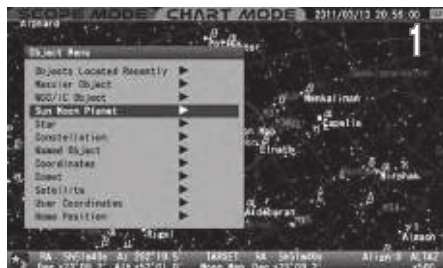

## Chapter 4 AUTOMATIC GOTO SLEWING

3 Choose "Moon" with the  $\uparrow$  or  $\downarrow$  direction key and press the  $\text{ENTER}$  (or the  $\rightarrow$ ) key.



4 The "Moon Map" dialog box appears and choose "Moon Map" with the  $\uparrow$  or  $\downarrow$  direction keys and press the  $\text{ENTER}$  (or the  $\rightarrow$ ) key. If you are in SCOPE MODE, the "GOTO Message" is displayed. Choose OK and press the  $\text{ENTER}$  key to start the automatic Go-To slewing. The "Moon Map" dialog box appears on the screen with completion of the automatic slewing.

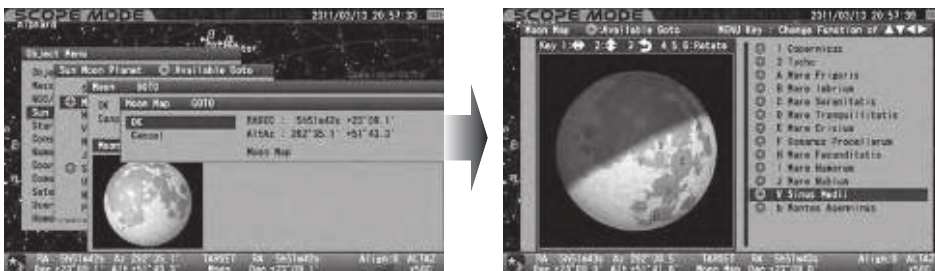

If you use CHART MODE on the screen, the "SELECT?" dialog box will be displayed. Choose OK and press the  $\text{ENTER}$  key to advance. The "Moon Map" dialog box appears. Press the  $\text{CLEAR}$  key to leave the "Moon Map" menu.

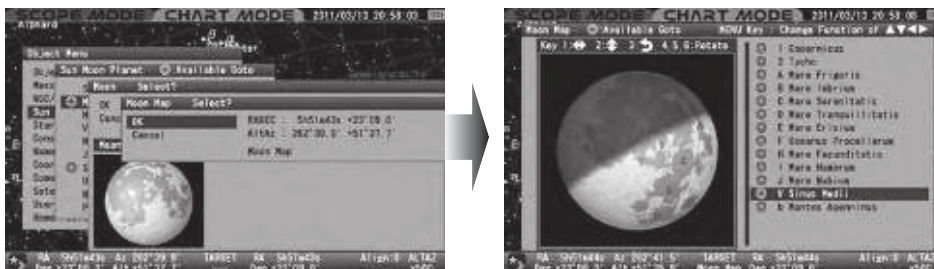

### Using the Moon Map

The orientation of the moon is displayed based on the setting in alt-azimuth or RA-DEC. The moon map enclosed with the black frame (frame mode) as shown below is the default option.

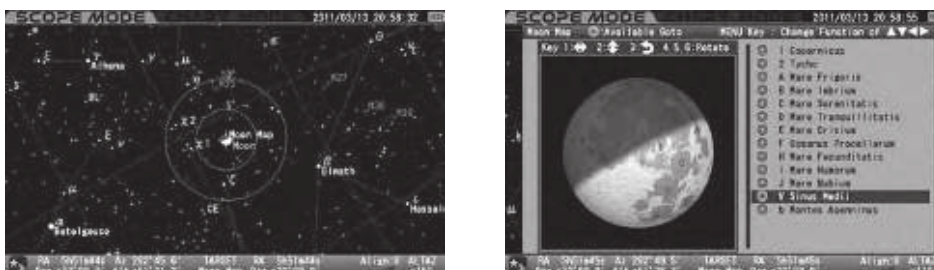

**Note:** The direction keys are linked to the motor's driving directions in SCOPE MODE.

# Chapter 4 AUTOMATIC GOTO SLEWING

## Descriptions of Moon Map Screens

### Screen 1: Changing the Size and Orientation of the Moon Map

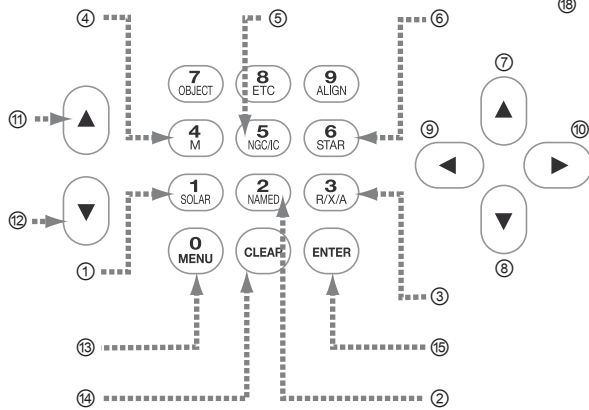
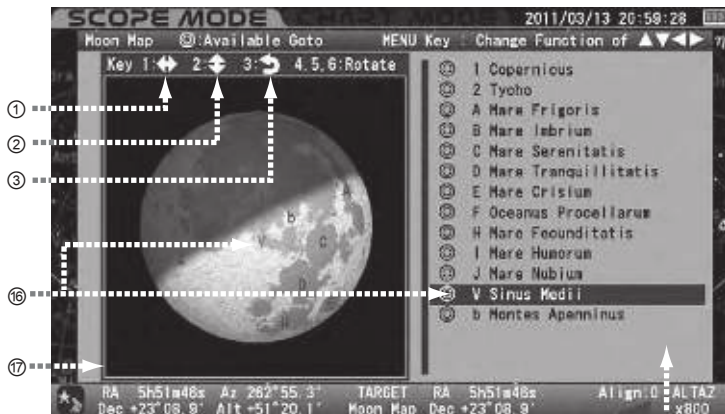

Item	Description
① (2) Key	Mirror-reversed left and right
② (2) Key	Mirror-revered upside-down
③ (3) Key	Rotate upside-down (180 degrees)
④ (4) Key	Rotate counterclockwise
⑤ (5) Key	Return
⑥ (6) Key	Rotate clockwise

#### Keys for scrolling

⑦ (▲) Key	Up Key moves the moon map downward.	
⑧ (▼) Key	Down Key moves the moon map upward.	
⑨ (◀) Key	Left Key moves the moon map right hand side.	
⑩ (▶) Key	Right Key moves the moon map left hand side.	
⑪ (▲) Key	Zoom In Key	Zooming in the moon map will show you details of the location.
⑫ (▼) Key	Zoom Out Key	

⑬ (0) Key	This switches the moon map to be movable or immovable when pressed.
⑭ (CLEAR) Key	This allows you to leave the moon map.
⑮ (ENTER) Key	This is used to choose your destination.

⑯	The name of a place that comes to the nearest to the center of the telescope's field of view (or the center of the shown mapped area) is indicated.
⑰	The moon map is movable if it is enclosed with the black frame. (Frame mode)
⑱	The list of the location names on the moon surface is displayed on the right side of the screen. The marks in front of the names of places stand for the following geographical features. <b>Capital letter</b> = Mare, Basin and Sinus <b>Small letter</b> = Mountain Range, Terrace and Rill <b>Number</b> = Crater

The above keys are linked to directions of the drive motors in **SCOPE MODE**.

### Screen 2: Indicating a Place on the Moon Map

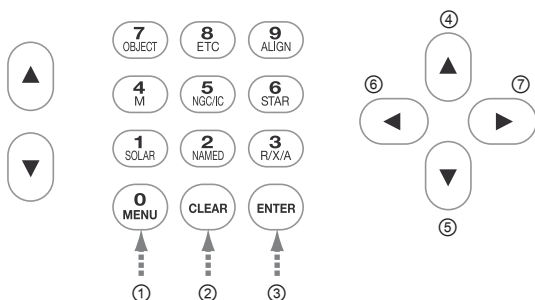
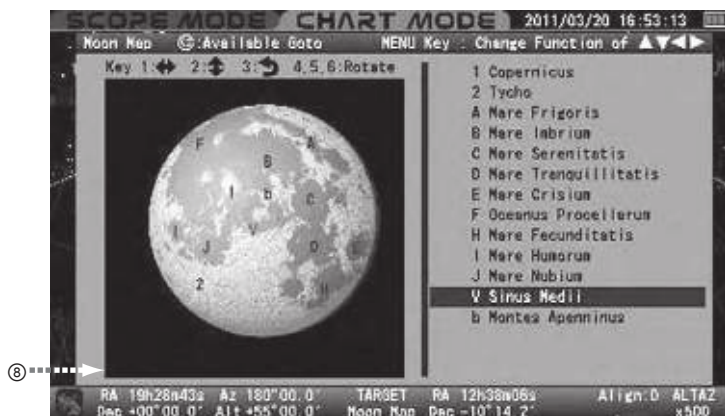

You can choose a place you want to observe from the list of the location on the moon surface.

Item	Description
① (0) Key	This switches the moon map between frame mode or not frame mode.
② (CLEAR) Key	This allows you to leave the moon map.
③ (ENTER) Key	This is used to choose your destination.

#### Keys for scrolling the cursor on the list of the location names.

④ (▲) Key	Up Key moves the cursor upward.
⑤ (▼) Key	Down Key moves the cursor downward.
⑥ (◀) Key	Left Key cancels the current choice and moves the screen a step back.
⑦ (▶) Key	Right Key allows entering your choice

⑧	The moon map is immovable with the direction keys when it is not enclosed with the black frame.
---	---

# Chapter 4 AUTOMATIC GOTO SLEWING

## Zooming In, Zooming Out and Scrolling the Moon Map (Refer to Screen 1)

1 Confirm that the moon map is in the frame mode. If not, press the **0** MENU key to switch to the frame mode. The zoom keys enlarge or reduce the size of the moon map as you press either the up or down key. Zooming in the moon map will display more details of the site.

2 The moon map can be scrolled up and down and left and right with the direction keys.

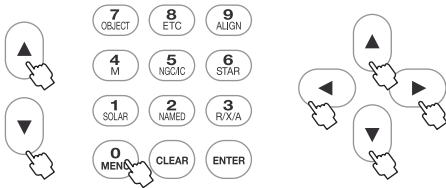

The moon map can be shifted up and down or left and right in the range of about 0.6 degrees radius from the center of the moon (1.35 times of the size of the moon exactly) regardless of the MODE chosen. Location names may not appear if the moon map is zoomed in too far.

You can scroll the list of the terrain names one by one with the up and down direction keys if the frame mode is not selected. In this option, the STAR BOOK TEN screen is not linked with the SXD2 mount and scrolls can be done smoothly and quickly. The zoom keys, reverse and rotation of the moon map are inoperative in this mode.

## Reversing and/or Rotating the Moon Map (Refer to Screen 1)

You can change the orientation of the moon map in accordance with the orientation of your view through your telescope. Display the moon map in the frame mode by pressing the **0** MENU key.

### Mirror-reversed Left and Right Moon Map

The moon map can be switched from/to the mirror-reversed left and right image to/from the ordinary image orientation with press of the **1** SOLAR key. The mirror-reversed left and right image symbol on the bar information of the moon map is highlighted in green if you choose this option. It functions along with the inverting image and rotating functions.

Ordinary Image orientation



### Mirror-reversed Upside-down Moon Map

The moon map can be switched from/to the mirror-reversed upside-down image to/from the ordinary image orientation with press of the **2** NAMED key. The mirror-reversed upside-down image symbol on the bar information of the moon map is highlighted in green if you choose this option. It functions along with the inverting image and rotating functions.

Ordinary Image orientation



Switching to a Mirror-reversed Upside-down Image

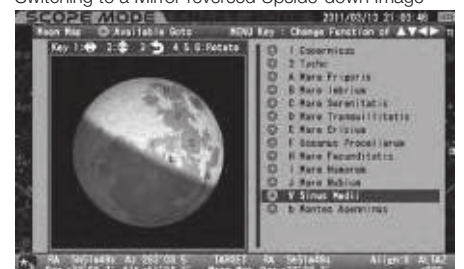

## Chapter 4 AUTOMATIC GOTO SLEWING

### Inverted (180-degree rotated) Moon Map

The moon map can be switched from/to the inverted image to/from the ordinary image orientation with press of the **3 R/X/A** key. The inverted image symbol on the bar information of the moon map is highlighted in green if you choose this option. It functions along with the mirror-reversed image and rotating functions.

Ordinary Image orientation



Switching to a Mirror-reversed Upside-down Image



### Rotating the Moon Map Clockwise or Counterclockwise

The moon map can be rotated voluntarily with the selection of the **4 M** or **6 STAR** key. The **4 M** key is used to rotate the moon map counterclockwise and the **6 STAR** key is used to rotate it clockwise. The rotated moon map is returned to the initial image orientation if the **5 NSCIC** is pressed. The word "Rotate" on the bar information of the moon map is highlighted in green if you choose this option. It functions along with the inverting and mirror-reversed image functions.

Ordinary Image orientation



Voluntary rotated Image



### Go-To Slewing

The Go-To slewing to geographical features of the moon's surface is available in both SCOPE MODE and CHART MODE by choosing the name of the location from the list or by choosing places marked in numbers or letters on the moon map.

Pressing the **0 MENU** key will switch the moon map to the non frame mode so that you can select the target from the name list of the locations on right side of the moon map. Scrolling and zooming of the moon map are disabled during this mode.

**Note:** Names marked © are available for Go-To slewing as they are located above the horizon but the terminator in phases of the moon is not considered.

As soon as you enter the moon map, it appears in frame mode. In SCOPE MODE, select a place you want to view on the moon map with using the zoom and direction keys.

Mare Serenitatis (Sea of Serenity) is a target here by way of example. Zooming in the moon map reveals detailed geographical features of the moon's surface.

In SCOPE MODE, the movement of your telescope is linked with the displayed moon map. The telescope may occasionally bring you to the object that you are targeting without starting the Go-To slewing.

The target is highlighted in red if it comes near the center of the moon map. Pressing the **ENTER** key will call up the dialog box to ask if you want to slew the telescope to Mare Serenitatis (Sea of Serenity). Choose "OK" and press the **ENTER** Key to proceed to the Go-To slewing.

As soon as the Go-To slewing finishes, the moon map around Mare Serenitatis is displayed.



To stop the Go-To slewing, press the direction key **◀** or **▶** or **⏪** to choose "Cancel" and press the **ENTER** key. The screen is turned back to the moon map chosen just before Go-To slewing. To leave the moon map press the **CLEAR** Key.

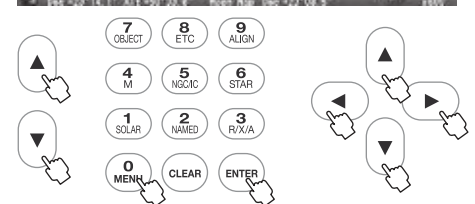

## Chapter 4 AUTOMATIC GOTO SLEWING

In CHART MODE, select a place you want to view on the moon map by scrolling and zooming with the direction keys and zoom keys. Copernicus crater is a target here by way of example.

The list of location names on the moon map tracks the terrain as you move the moon map.

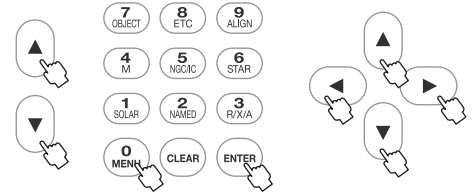

The target is highlighted in red if it comes near the center of the moon map. Pressing the **ENTER** key will call up the dialog box to ask if you want to slew the telescope to Copernicus crater.

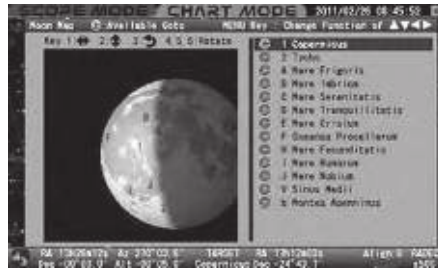

Choose OK and press the **ENTER** Key to proceed to the Go-To slewing. The screen changes to SCOPE MODE instantaneously.

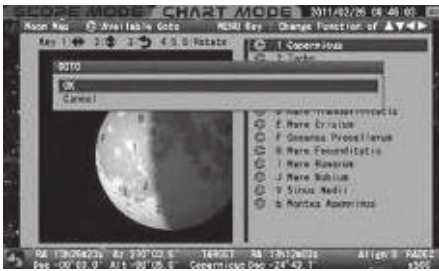

### Note:

- The list of location names of the moon (as of November 2011)
- Craters are displayed as numbers from 1 to 115.
- Sea (Mare), lake (Lacus), marsh (Palus) and bay (Sinus) are displayed in capital letters.
- Mountain, rille, scarp and valley are displayed in small letters.



## INDEX

### Craters

Albategnius	045	Geminus	057	Posidonius	013
Alphonsus	008	Goclenius	061	Ptolemaeus	007
Archimedes	011	Goldschmidt	114	Purbach	073
Aristarchus	010	Grimaldi	028	Pythagoras	112
Aristillus	034	Guericke	043	Rabbi Levi	068
Aristotle	012	Gutenberg	031	Regiomontanus	074
Arzachel	009	Hainzel	088	Reinhold	038
Atlas	055	Harpalus	111	Riccioli	098
Autolycus	035	Hedin	100	Römer	032
Billy	097	Hercules	054	Russell	107
Blancanus	080	Hevelius	099	Santbech	063
Boscovich	046	Julius Caesar	047	Scheiner	084
Briggs	108	Kepler	029	Schickard	026
Bullialdus	030	Kraft	103	Schiller	090
Burg	051	Krasnov	095	Seleucus	104
Campanus	085	Lagrange	091	Sharp	110
Capuanus	087	Lamarck	092	Snellius	065
Cardnus	102	Lambert	037	Stadius	004
Cassini	033	Landberg	039	Stevinus	066
Catharina	021	Langrenus	015	Stöffler	024
Clavius	006	Longomontanus	083	Struve	106
Cleomedes	014	Macrobius	059	Taruntius	060
Columbus	062	Maginus	078	Theophilus	019
Copernicus	001	Mairan	109	Timocharis	036
Crüger	096	Manilius	048	Tycho	002
Curtius	077	Manzinus	076	Vendelinus	016
Cyrillus	020	Marius	101	Vlacq	071
Darwin	094	Massala	056	W. Bond	115
De La Rue	052	Maurolucus	023	Walter	075
Eddington	105	Mee	089	Wilhelm	082
Endymion	053	Mercator	086	Zagut	067
Eratosthenes	003	Mersenius	093		
Eudoxus	050	Metius	069		
Fabricius	070	Moretus	079		
Faraday	025	Parry	042		
Flammarion	044	Petavius	017		
Fra Mauro	041	Philolaus	113		
Fracastorius	064	Piccolomini	022		
Furnerius	018	Pitatus	081		
Gambert	040	Pitiscus	072		
Gassendi	027	Plato	005		
Gauss	058	Pliny	049		

### Seas, Ocean, Bays, Lakes and Marsh

Mare Australe (Southern Sea)	O
Mare Crisium (Sea of Crises)	E
Mare Fecunditatis (Sea of Fertility)	H
Mare Frigoris (Sea of Cold)	A
Mare Humboldtianum (Humbolt Sea)	L
Mare Humorum (Sea of Moisture)	I
Mare Imbrium (Sea of Rain)	B
Mare Nectaris (Sea of Nectar)	K
Mare Nubium (Sea of Clouds)	J
Mare Orientale (Eastern Sea)	N
Mare Serenitatis (Sea of Serenity)	C
Mare Smythii (Sea of Smith)	M
Mare Tranquillitatis (Sea of Tranquility)	D
Mare Vaporum (Sea of Vapors)	G
Oceans Procellarum (Ocean of Storm)	F
Lacus Mortis (Lake of the Dead)	P
Lacus Somniorum (Lake of Dreams)	Q
Lacus Temporis	R
Sinus Iridum (Rainbow Bay)	S
Sinus Roris (Bay of Dew)	T
Sinus Aestuum (Seething Bay)	U
Sinus Medii (Central Bay)	V
Sinus Amoris	W
Palus Epidemiarum	X
Palus Putredinis (Marsh of Decay)	Y

### Mountains, Scarps, Valleys and Rills

Montes Alpes (Alps Mountains)	a
Montes Apenninus (Apennine Mountains)	b
Montes Carpatus (Carpathian Mountains)	c
Montes Caucasus (Caucasian Mountains)	f
Montes Haemus (Haemus Mountains)	g
Montes Jura (Jura Mountains)	e
Montes Pyrenaeus (Pyrene Mountains)	d
Montes Taurus (Taurus Mountains)	h
Rupes Altai (Altai Scarp)	j
Rupes Recta (Straight Wall)	i
Rima Ariadaeus	l
Rima Hyginus (Hyginus Cleft)	m
Rima Sharp	o
Vallis Rheita (Rheita Valley)	k
Vallis Schroteri (Schroter's Valley)	n

# Chapter 4 AUTOMATIC GOTO SLEWING

The following is an example on how to slew to NG/C224 (M31, the Andromeda galaxy) with the **5** NGC/IC command key.

1 Press the **5** NGC/IC key to access the lists of objects in the NGC or IC catalog. Pressing the **0** MENU key will switch the catalogs.

**Note:**

Switching by the **0** MENU key is only available when it is used with the **5** NGC/IC command key. The switching function of the **0** MENU key is not applicable with the other **0** MENU, **2** NAMED, **4** M, **6** STAR command keys.

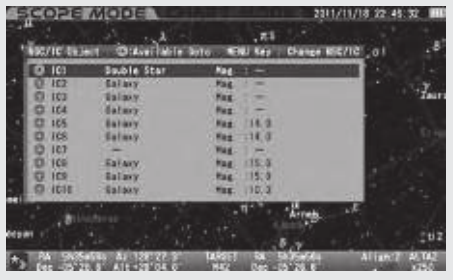

2 Choose NGC224 in the NGC catalog with the **▲** or **▼** direction key.\*1 \*2 \*3



\*1 The **☉** marked objects can be seen above the horizon of your observing site. If you choose an object with no **☉** mark, the message "Unable to GO below horizon!" is displayed. Information about the object is displayed, but you cannot slew to it.

\*2 Using the **▲** or **▼** zoom key will shift the cursor 5 lines.

\*3 The numerical keys are available to call up Messier, NGC and IC objects by number. Enter **2** NAMED, **2** NAMED, **4** M by using the numerical keys.

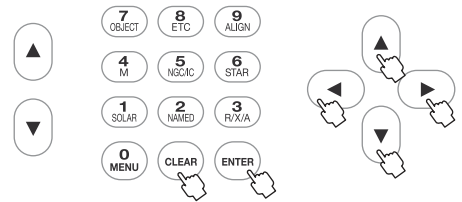

3 Press the **ENTER** or **▶** direction key to choose NGC224. The dialog box appears to confirm to proceed to the Go-To slewing.

Press the **ENTER** key to start. To stop, shift the cursor to Cancel with the **▲** or **▼** direction key and press the **ENTER** (or **◀**) key.

The dialog box disappears and you are ready to choose another. If you discontinue the Go-To slewing itself, press the **CLEAR** key.

The telescope starts moving toward the target object.

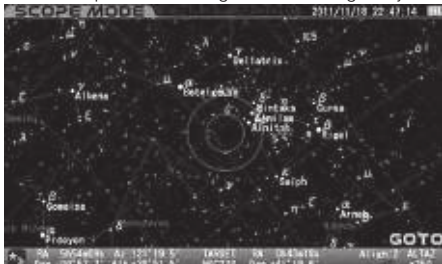

The telescope arrives at the target object.



The Go-To slewing finishes with ringing the chimes.

# Chapter 4 AUTOMATIC GOTO SLEWING

**7 OBJECT** This displays all of the celestial objects in the database.

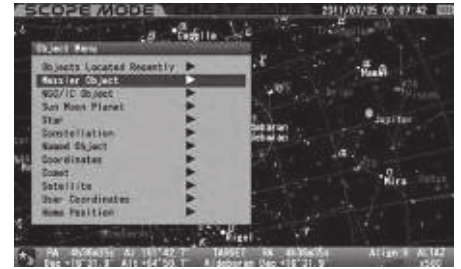
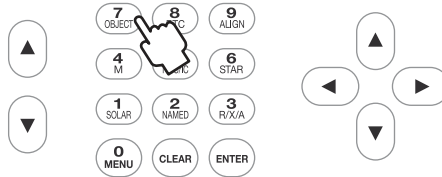

Press the **ENTER** key to call up "Object Menu" which includes each list of Messier objects, NGC/IC objects, planets, the sun, the moon, constellations, fixed stars and more. Select the list using the **▲** or **▼** key and press **ENTER** (or **▶**) key.

**Messier Object** ▶

This equals the **4 M** key.

**NGC / IC Object** ▶

This equals the **5 NGC/IC** key.

**Sun Moon Planet** ▶

This equals the **1 SOLAR** key.

**Star** ▶

This equals the **6 STAR** key.

**Named Object** ▶

This equals the **2 NAMED** key.

## Recently Located Objects

The 20 most recent objects selected from the "Object Menu" are stored in the memory of the STAR BOOK TEN. This is saved after the power is turned off and is available as your Go-To together for your next observing session. The stored data can be erased by initializing the memory in "System Menu".

**1** Press the **7 OBJECT** key to call up the "Object Menu". Select "Object Located Recently" at the top of the list by pressing the **ENTER** (or the **▶**) key. The moon map can be scrolled up and down and left and right with the direction keys.

**2** Up to 20 of your most recently viewed objects are listed. Choose your target object with the **▲** or **▼** direction keys for Go-To slewing.

The **Ⓞ** marked objects are only available for observation if they are above the horizon at your observing site. A message "Unable to GO below horizon" is displayed if you choose an object with no **Ⓞ** mark. Information about the object is displayed, but you cannot slew to it.

**3** Press the **◀** direction key to leave the list of "Objects Located Recently", or press the **CLEAR** key to instantly close the "Object Menu" and continue the CHART MODE or SCOPE MODE screen.

If there is no list of "Objects Located Recently" to be available, the **▶** mark does not appear on the right side of the description in the "Object Menu" dialog box. You cannot step down to the subsequent dialog box if this is the case.

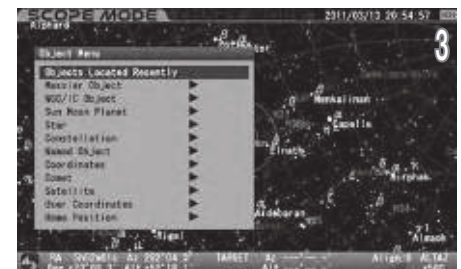
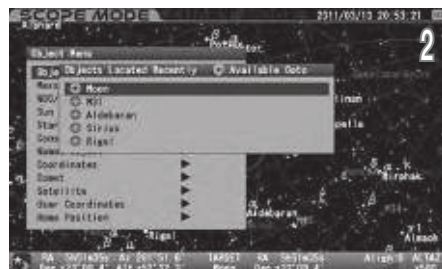
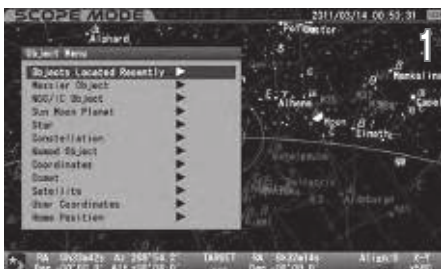

# Chapter 4 AUTOMATIC GOTO SLEWING

## Constellation

This identifies locations of all 88 constellations. Additionally, it allows you to slew to any stars labeled with a Bayer designation (the letters of Greek alphabet) in the constellation.

1 Call up "Object Menu" and choose "Constellation" with the  $\uparrow$  or  $\downarrow$  direction key. Press the  $\text{ENTER}$  (or  $\rightarrow$ ) key to access a list of 88 constellations.

2 Choose the constellation you want to view with the  $\uparrow$  or  $\downarrow$  key and press  $\text{ENTER}$  (or  $\rightarrow$ ) key.

3 Press the  $\text{ENTER}$  key to start the Go-To slewing. To stop, shift the cursor to Cancel with the  $\uparrow$  or  $\downarrow$  direction key and press the  $\text{ENTER}$  (or  $\rightarrow$ ) key.

The dialog box disappears and you are ready to choose another. If you discontinue the Go-To slewing itself, press the  $\text{CLEAR}$  key.

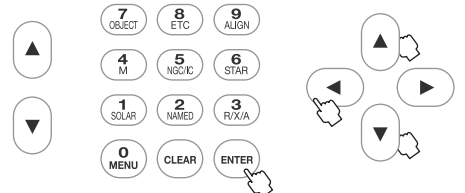
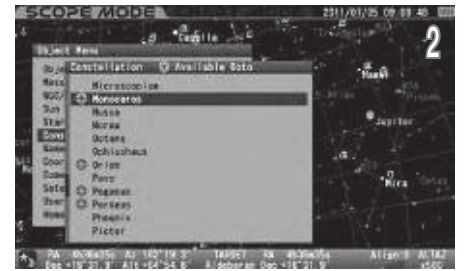
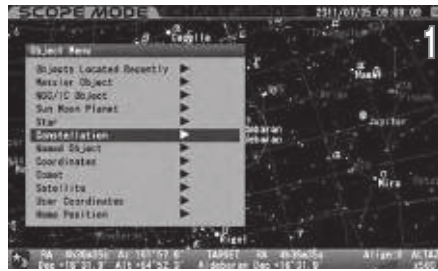

4 Stars shown in constellations can be identified by a Bayer designation which is assigned to a star.

Here, Gamma Monoceros (the Unicorn) is chosen as an example.

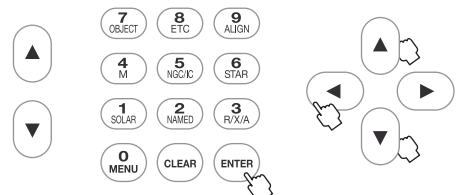
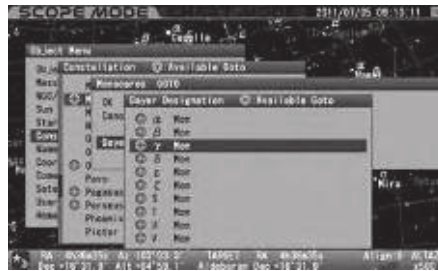

5 Choose a star you want to slew to with the  $\uparrow$  or  $\downarrow$  key and press the  $\text{ENTER}$  (or  $\rightarrow$ ) key.



# Chapter 4 AUTOMATIC GOTO SLEWING

## Calling up Bayer Designation Directly

The list of the Bayer designation appears on the screen if you press the **6 STAR** key a little longer

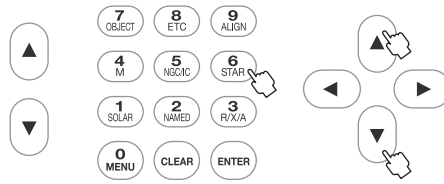

Choose a Bayer designation in the entry dialog box with the **▲** or **▼** direction key. Press the **ENTER** (or **▶**) key to display a star which have a Greek-letter designation.



## Coordinates

This allows slewing to objects by entering celestial coordinates or altitude/azimuth directions.

- 1 Call up "Object Menu" and choose "Coordinates" with the **▲** or **▼** direction key. Press the **ENTER** (or **▶**) key to access the entry dialog box.
- 2 Choose "RADEC" or "AltAz" with the **▲** or **▼** direction key and advance the cursor to an available entry space with the **▶** or **◀** direction key. Enter a numerical value with the **▲** or **▼** key and press the **ENTER** key.
- 3 Press the **ENTER** key to start the Go-To slewing. To stop, shift the cursor to Cancel with the **▲** or **▼** direction key and press the **ENTER** (or **◀**) key. The entry dialog box disappears.

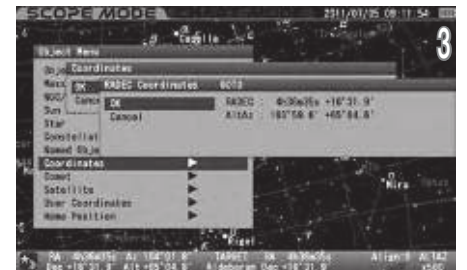
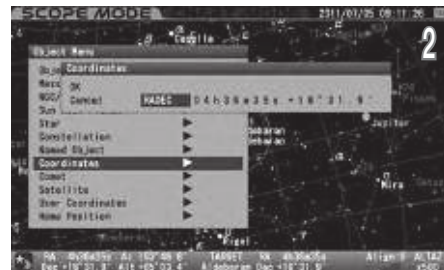
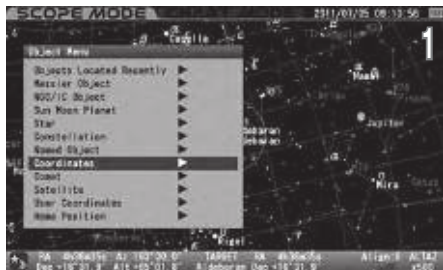

If you enter a wrong number or your target is below the horizon, you will be alerted by a message on the screen.

The wrong number is entered.



The target is below the horizon.

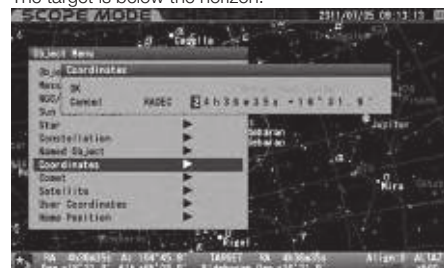

# Chapter 4 AUTOMATIC GOTO SLEWING

## Comet

This allows slewing to comets. The orbital elements of the comet McNaught (2009 R1) are shown as an example.

### Entering the Orbital Elements of the Comet

STAR BOOK TEN allows you to enter orbital elements of up to 10 comets for Go-To slewing. You can access the orbital elements of comets from commercially available astronomy magazines, internet websites and so forth. Use the most recent ones to prevent inaccurate slewing to the comet and to diminish tracking errors.

- 1 Call up "Object Menu" and choose "Comet" with the  $\uparrow$  or  $\downarrow$  direction key. Press the  $\text{ENTER}$  (or  $\rightarrow$ ) key to access the entry dialog box.
- 2 With the  $\uparrow$  or  $\downarrow$  direction key, move the cursor to an available entry space where no comet names are set. (The third line is chosen here.) Press the  $\text{ENTER}$  key to display the "New Object" dialog box and move the cursor to an available entry space with the  $\rightarrow$  or  $\leftarrow$  direction key.
- 3 Enter the name of the comet and its orbital elements by alphabet and number with the  $\uparrow$  •  $\downarrow$  direction key.

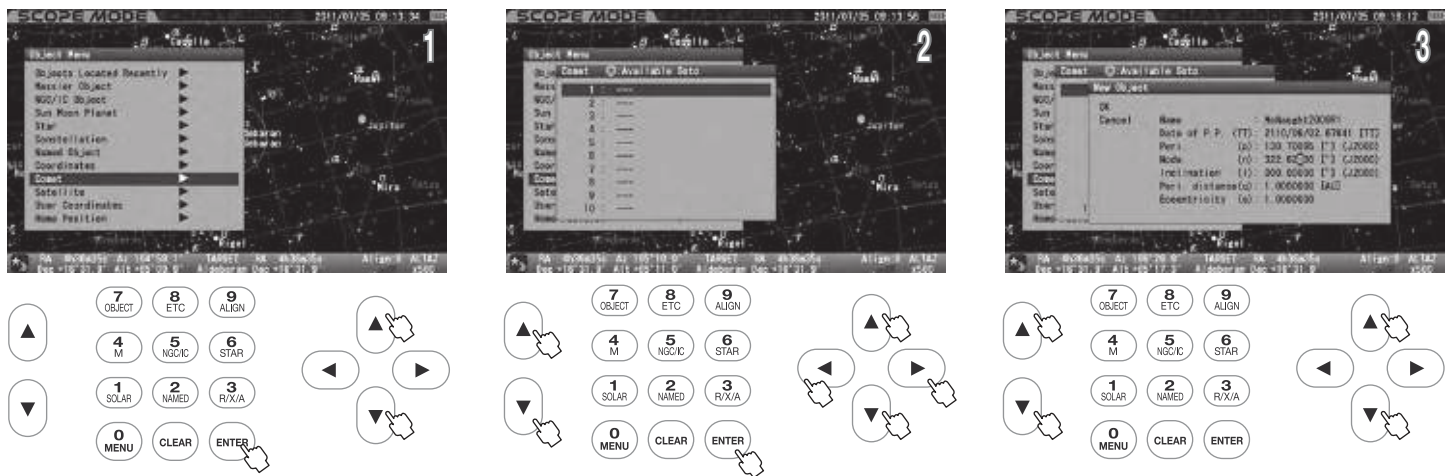

### The orbital elements of the comet McNaught (2009 R1)

Code Name	2009 R1
Time of Pericenter Passage (T)	2010 / 6 / 2.67841 TT
Argument of Pericenter ( $\omega$ )	130.70095
Longitude of the Ascending Node ( $\Omega$ )	322.62188
Inclination ( $i$ )	77.03226
Minimum Distance from Pericenter ( $q$ )	0.4050263 AU
Eccentricity ( $e$ )	1.0003431

EPOCH = June 13.0, 2010

When figuring the decimal fraction for orbital elements, the resulting number must have three spaces before the decimal and the number after the decimal is determined by the number of spaces available. Round off at that point.

**Note :** Use the  $\uparrow$  or  $\downarrow$  zoom key to shift the cursor in the vertical direction while you enter alphabets and numbers.

(Here, the  $\uparrow$  •  $\downarrow$  direction keys are not allocated for moving the cursor.)

- 4 Press the  $\text{ENTER}$  key to complete the entry. Then, press the  $\text{ENTER}$  key again to leave this menu.

If a wrong number is entered, the item for the entry will be highlighted in red to alert you.

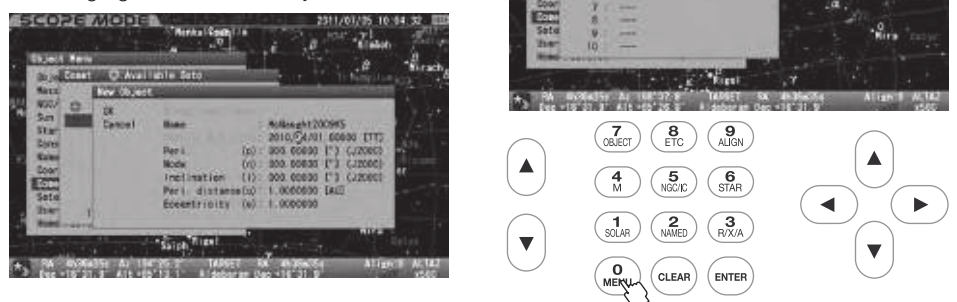

## Chapter 4 AUTOMATIC GOTO SLEWING

### Setting, Changing or Deleting the Orbital Elements of the Comet

**OK:** Choose OK to slew the telescope to the comet you chose.

Press the **ENTER** key to start the Go-To slewing. To stop, shift the cursor to Cancel with the **◀** or **▶** direction key and press the **ENTER** (or **◀**) key. The entry dialog box disappears and you are ready to choose another.

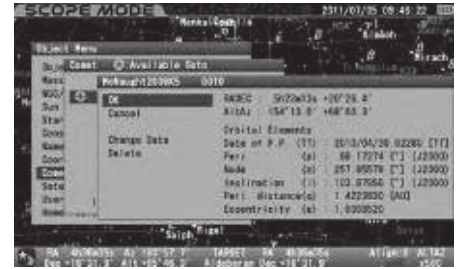

**Change Data:** Choose “Change Data” to rewrite the orbital elements.

To change the parameters of the set orbital elements, display the entry dialog box and choose “Change Data” with the **▲** or **▼** direction key. Then, press the **ENTER** key to change the parameters.

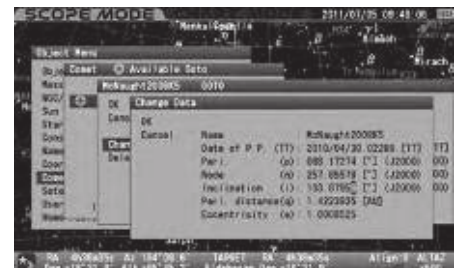
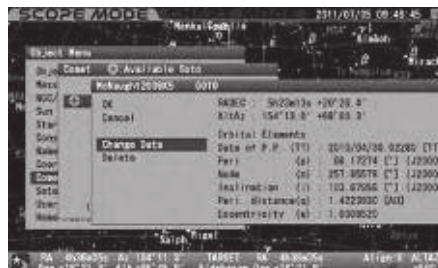

**Delete:** Choose “Delete” to clear the orbital elements.

To delete the entered orbital elements of a comet, display the entry dialog box and choose “Delete” with the **▲** or **▼** direction key. Then, press the **ENTER** key.

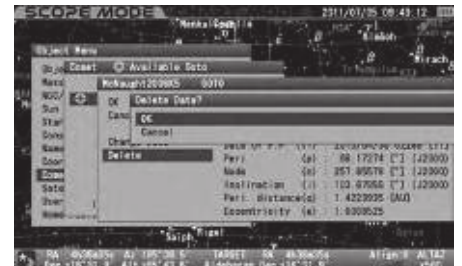
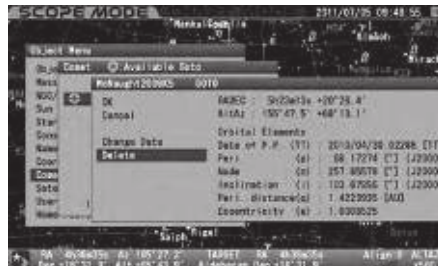

**Note:** If your STAR BOOK TEN is connected to a PC with LAN, the orbital elements can be input, changed or deleted through the PC.

# Chapter 4 AUTOMATIC GOTO SLEWING

## Satellite (Artificial Satellite)

This allows observing a satellite pass.

### Entering the Orbital Elements of the Satellite

STAR BOOK TEN allows you to enter orbital elements of up to 10 satellites for Go-To slewing. You can access the orbital elements of satellites from commercially available astronomy magazines and internet websites. Use the most recent ones to prevent inaccurate slewing to the satellite and to diminish tracking errors. Besides, it is very important to set your STAR BOOK TEN to be punctual to the second.

- 1 Call up "Object Menu" and choose "Satellite" with the  $\uparrow$  or  $\downarrow$  direction key. Press the  $\text{ENTER}$  (or  $\rightarrow$ ) key to access the entry dialog box.
- 2 With the  $\uparrow$  or  $\downarrow$  direction key, move the cursor to an entry space where no satellite names are set. (The second line is chosen here.)
- 3 Press the  $\text{ENTER}$  key to display the "New Object" dialog box and move the cursor to an available entry space with the  $\rightarrow$  or  $\leftarrow$  direction key. Enter the name of the satellite and its orbital elements by alphabet and number with the  $\uparrow \bullet \downarrow$  direction key.

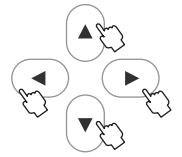
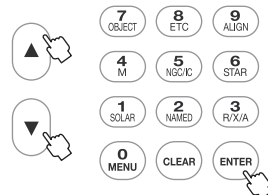
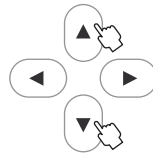
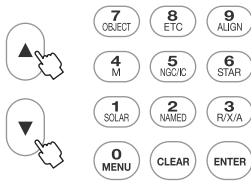
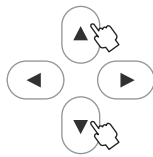
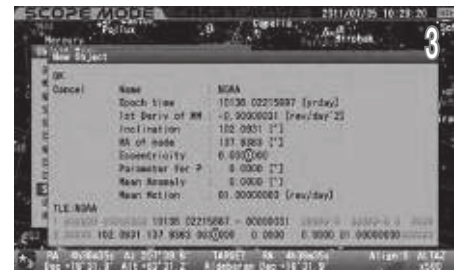

**Note :** Use the  $\uparrow$  or  $\downarrow$  zoom key to shift the cursor in the vertical direction while you enter alphabets and numbers. (Here, the  $\uparrow \bullet \downarrow$  direction keys are not allocated for moving the cursor.)

The orbital elements of the weather satellite NOAA is shown in TLE format as an example.

```
1 04793U 70106A 10136.02215887 -.00000031 00000-0 10000-3 0 5176
2 04793 102.0931 137.9363 0031946 163.7080 196.5027 12.53938386804630
```

The orbital elements of the satellites are typically represented in a format that is called "Two Line Elements". Sampling parameters related to the orbital elements of the satellite and its name only from the TLE format and enter them into the STAR BOOK TEN.

The TLE format consists of the following structure.

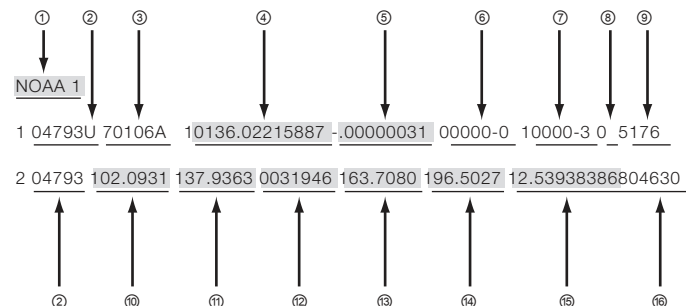

- ① Name of Satellite
- ② Satellite Number
- ③ International Designation
- ④ Epoch Year & Day Fraction
- ⑤ 1st derivative of Mean Motion
- ⑥ 2nd derivative of Mean Motion
- ⑦ Radiation Pressure Coefficient
- ⑧ Ephemeris Type
- ⑨ Element Number & Checksum
- ⑩ Inclination
- ⑪ Right Ascension of the Ascending Node
- ⑫ Eccentricity (decimal place)
- ⑬ Argument of Perigee
- ⑭ Mean Anomaly
- ⑮ Mean Motion
- ⑯ Revolution Number at Epoch & Checksum

Of the above parameters in TLE format, ① ④ ⑤ ⑩ ⑫ ⑬ ⑭ ⑮ ⑯ are utilized for determining orbital elements. (The parameters ② ③ ⑥ ⑦ ⑧ ⑨ ⑰ are not necessary for the STAR BOOK TEN.) The number after the decimal is determined by the number of spaces available and round off at that point.



## Chapter 4 AUTOMATIC GOTO SLEWING

4 Press the **ENTER** key to complete the entry. Then, press the **ENTER** key again to leave this menu. If a wrong number is entered, the item for the entry will be highlighted in red to alert you.

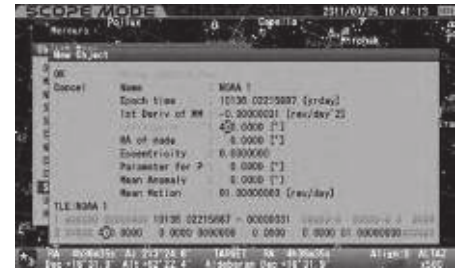

### Setting, Changing or Deleting the Orbital Elements of the Satellite

OK: Choose OK to slew the telescope to the satellite you chose.

Press the **ENTER** key to start the Go-To slewing. To stop, shift the cursor to Cancel with the **◀** (or **▲** • **▼**) direction key and press the **ENTER** (or **◀**) key. The entry dialog box disappears and you are ready to choose another.

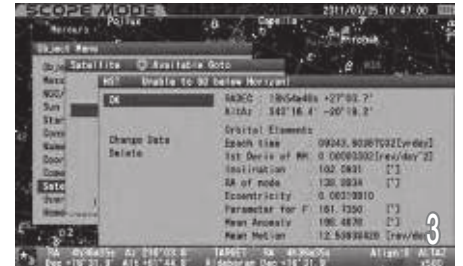

**Change Data:** Choose “Change Data” to rewrite the orbital elements.

To change the parameters of the set orbital elements, display the entry dialog box and choose “Change Data” with the **▲** or **▼** direction key.

Then, press the **ENTER** key to change the parameters.

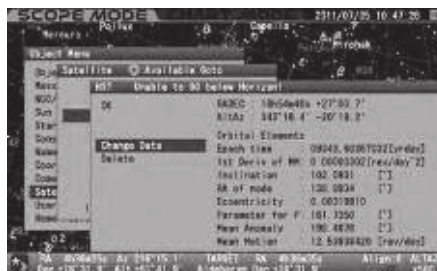

**Delete:** Choose “Delete” to clear the orbital elements.

To delete the parameters of the set orbital elements, display the entry dialog box and choose “Delete” with the **▲** or **▼** direction key. Then, press the

**ENTER** key.

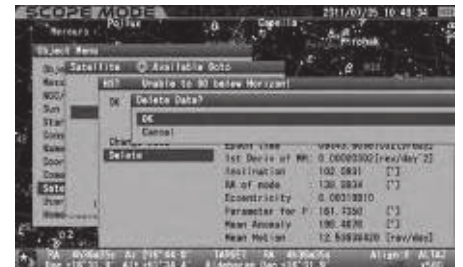
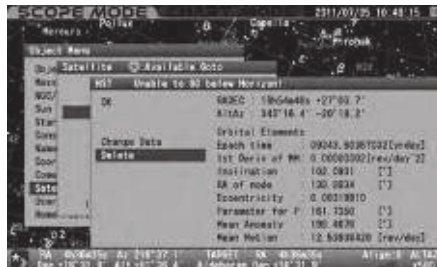

# Chapter 4 AUTOMATIC GOTO SLEWING

## User Coordinates

STAR BOOK TEN allows you to add 10 new objects to the database by using celestial coordinates. It is possible to define and store terrestrial objects with altitude and azimuth for terrestrial objects. The tracking will be off if you choose an object in the altitude and azimuth setting.

1 Call up "Object Menu" and choose "User Coordinates" with the  $\uparrow$  or  $\downarrow$  direction key. Press the  $\text{ENTER}$  (or  $\rightarrow$ ) key to access the entry dialog box.

2 With the  $\uparrow$  or  $\downarrow$  direction key, move the cursor to an available entry space where no user coordinates are set. (The third line is chosen here.) Press the  $\text{ENTER}$  key to display the "New Object" dialog box to make your option.

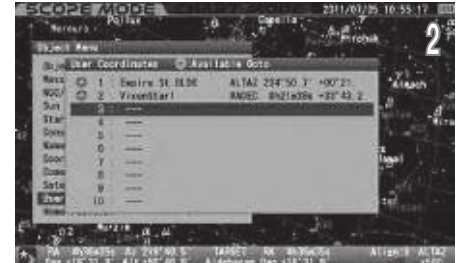
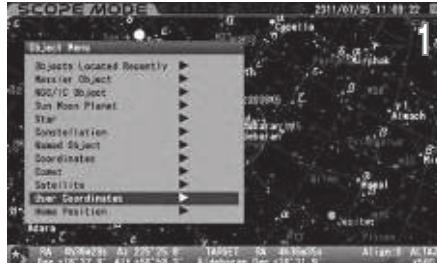

### Setting a Point by Coordinates

In the "New Object" dialog box of "User Coordinates", the position that your telescope is pointing is indicated in RA and DEC and it can be stored in the database. For terrestrial objects, bring the cursor to "RADEC" with the  $\uparrow$  or  $\downarrow$  zoom key to switch the indication to "AltAz" with the  $\uparrow$  or  $\downarrow$  direction key.

Access the "User Coordinates" dialog box and move the cursor to an available entry space with the  $\uparrow$  •  $\downarrow$  direction key.

Press the  $\text{ENTER}$  key to display the "New Object" dialog box and move the cursor to an available entry space with the  $\rightarrow$  •  $\leftarrow$  •  $\uparrow$  •  $\downarrow$  direction key.

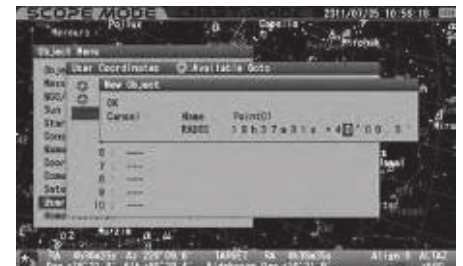

Enter the name and its location of the point by alphabet and number with the  $\uparrow$  or  $\downarrow$  direction key. Press the  $\text{ENTER}$  key to complete the entry. Then, press the  $\text{ENTER}$  again to leave this menu.

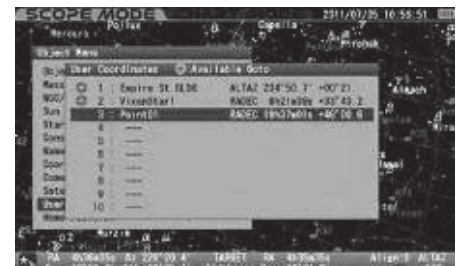

**Note :** Use the  $\uparrow$  or  $\downarrow$  zoom key to shift the cursor in the vertical direction while you enter alphabets and numbers. (Here, the  $\uparrow$  •  $\downarrow$  direction keys are not allocated for moving the cursor.)

If a wrong number is entered, the item for the entry will be highlighted in red color to alert you.

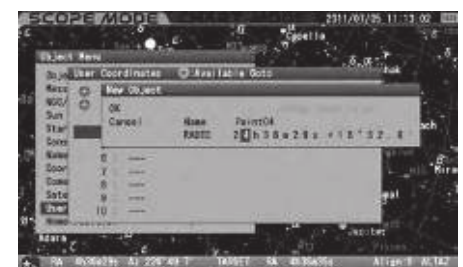

### Slewing to the Set Point, Changing or Deleting the Point

Access the "User Coordinates" dialog box and move the cursor to the point you slew to with the  $\uparrow$  •  $\downarrow$  direction key.

Press the  $\text{ENTER}$  (or  $\rightarrow$ ) key to display the entry dialog box. Choose OK or "Change Data" or "Cancel" at your option with the  $\uparrow$  or  $\downarrow$  direction key.

OK: Choose OK to slew the telescope to the point you chose.

Press the  $\text{ENTER}$  key to start the Go-To slewing. To stop, shift the cursor to Cancel with the  $\leftarrow$  (or  $\uparrow$  •  $\downarrow$ ) direction key and press the  $\text{ENTER}$  (or  $\leftarrow$ ) key. The entry dialog box disappears and you are ready to choose another.



## Chapter 4 AUTOMATIC GOTO SLEWING

Change Data: Choose “Change Data” to rewrite the set points.

To change the set point, display the entry dialog box and choose “Change Data” with the  $\uparrow$  or  $\downarrow$  direction key. Then, press the  $\text{ENTER}$  key.



Delete: Choose “Delete” to clear the orbital elements.

To delete the set point, display the entry dialog box and choose “Delete” with the  $\uparrow$  or  $\downarrow$  direction key. Then, press the  $\text{ENTER}$  key.

**Note :** If your STAR BOOK TEN is connected to a PC with LAN, the orbital elements can be input, changed or deleted through the PC.

### Home Position

This allows you to return the telescope to the initial setting position without loosening the RA and DEC lock levers on the mount, and assures that the mount retains all the alignments. The telescope slews back to the initial setting position where the telescope tube is level and points to the west.

**Note :** The telescope may not return to the initial setting position if the lock levers are unlocking during observation.

1 Call up “Object Menu” and choose “Home Position” with the  $\uparrow$  or  $\downarrow$  direction key.



2 Press the  $\text{ENTER}$  (or  $\rightarrow$ ) key and the dialog box appears to confirm if you slew the telescope to the home position. Choose OK or Cancel with the  $\uparrow$  or  $\downarrow$  direction key and press the  $\text{ENTER}$  key.



## Chapter 5 APPLICATION

### I. How to Use the Polar Axis Scope

#### What is a Polar Axis Scope?

The polar axis scope is a small telescope that is installed parallel to the R.A axis of the SXD2 Mount that enables you to point precisely to the north (or south) celestial pole. Accurate polar alignment is essential for successful long exposure astrophotography of deep sky objects with the equatorial mount. Check longitude and latitude of your observing site with a GPS system or a map before the polar alignment. The polar axis scope allows you to accurately align the mount to Polaris at 3 arc minutes or less.

#### CAUTION

\* Inaccurate polar alignment could result in trailed stars and field rotation in your imaging device.

\* It is not possible to use the SXD2 mount in the north latitude over 70 degrees and in the south latitude over 70 degrees.

#### Polar Axis Scope Components

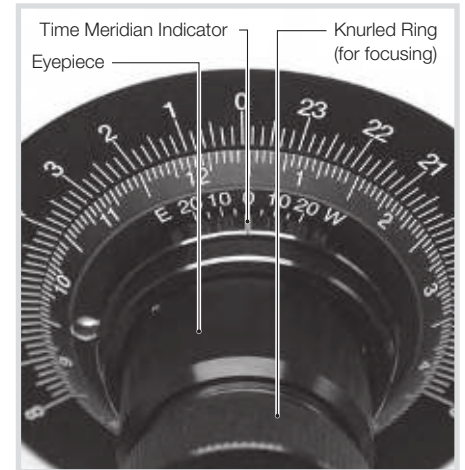
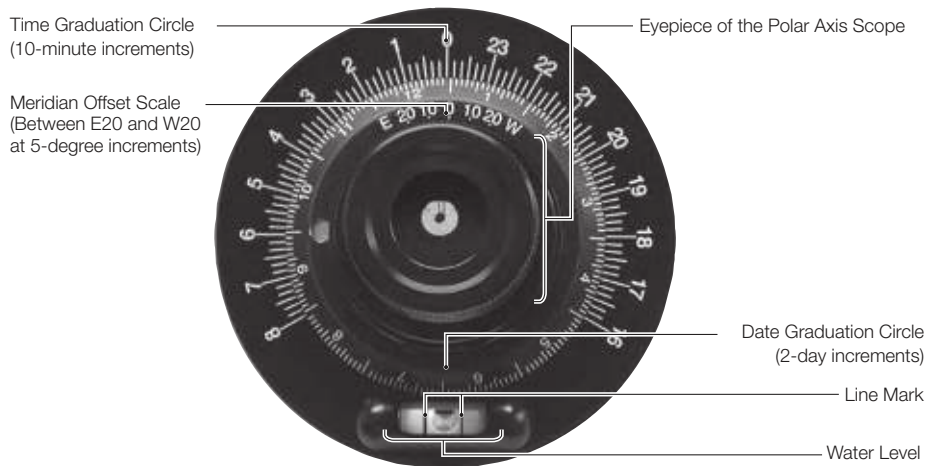

#### Polar Alignment in the Northern Hemisphere

1 Set up the telescope on flat and hard ground where you can see Polaris in the sky. Point the polar axis of the SXD2 mount in the direction of north as shown in the figure. Adjust the tripod legs so that will the tripod is as level as possible.

2 Take off the declination cap and polar axis cap. These caps can be removed readily by twisting counter-clockwise.

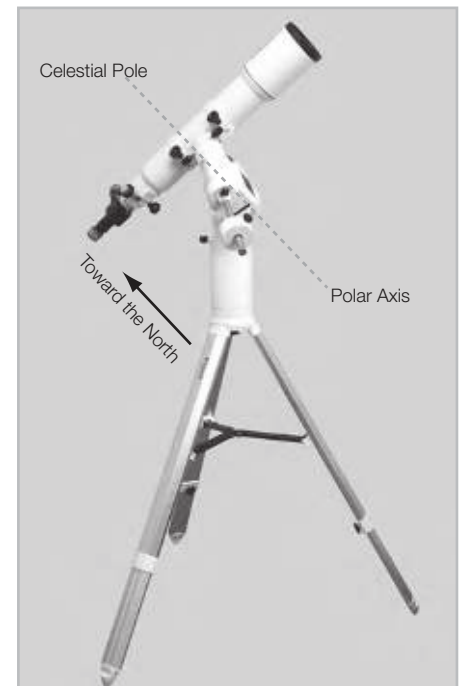
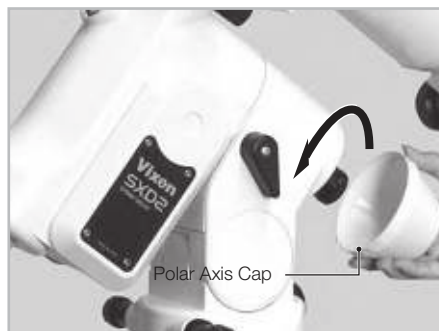

3 Turn on the power switch of the mount and advance the initial settings until the telescope's home position screen appears on the screen of the STAR BOOK TEN.

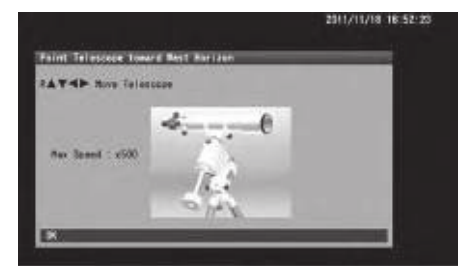

## Chapter 5 APPLICATION

4 While looking into the opening of the polar axis scope on the declination body, turn the declination body with the  $\uparrow$  or  $\downarrow$  direction key so that the objective lens of the polar axis scope can be seen in the opening.

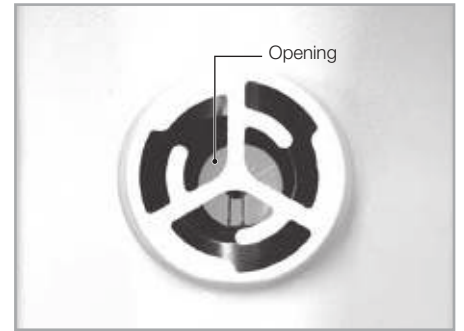

5 Loosen the altitude clamp lever and turn the altitude adjustment knob so that the indicator of the altitude scale fits the latitude of your observing site. The mount is set at an altitude of approximately 35 degrees at Vixen's factory.

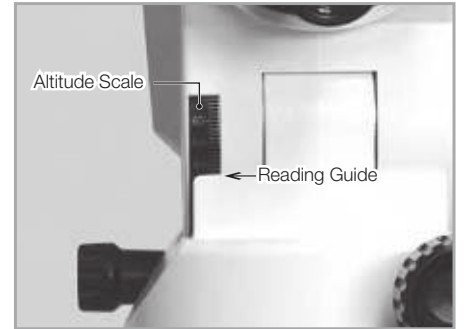
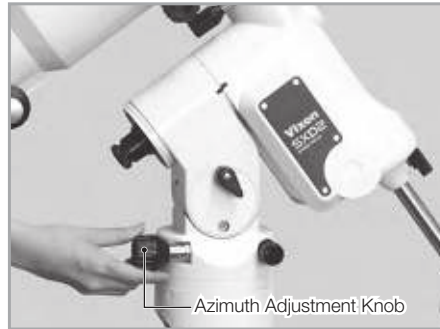

6 While looking into the eyepiece of the polar axis scope, turn the focus ring until the reticle is in focus. Hold the eyepiece tube with the other hand while you turn the focus ring.



7 Adjust the brightness of the illuminator for the polar axis scope so that the reticle is dimly illuminated.

8 Turn the time graduation circle by holding both sides of the bubble level so that the bubble is brought into the center of the level marks.

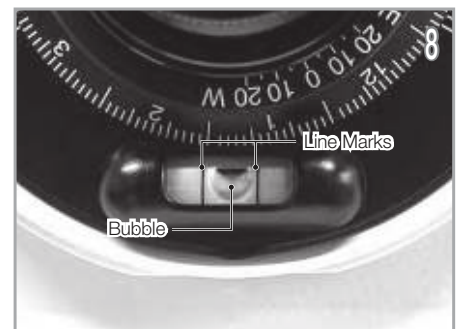

9 Check the difference between standard time meridian of your region (or country) and your observing site on a map of the area or by using a GPS system.



Examples: US Time Zones and Standard Time Meridian (West Longitude)

Atlantic	60 degrees
Eastern	75 degree
Central	90 degrees
Pacific	105 degrees
Alaska	135 degrees
Hawaii	150 degrees

If the observing site is east of standard time meridian, rotate the time-meridian offset scale in the direction as indicated by „E“. If the observing site is west of standard time meridian, rotate the time-meridian offset scale in the direction as indicated by „W“. Turn the time-meridian offset scale while holding the eyepiece tube with the other hand.

## Chapter 5 APPLICATION

### Meridian Offset Setting for the Polar Axis Scope

Example City: Boston, USA

If you observe in Boston, MA, which is located at 71 degrees longitude, you need to offset by 4 degrees in the direction of E from the central meridian of the Eastern Standard Time after the calibration.

Example City: Dallas, USA

If you observe in Dallas, TX, which is located at 97 degrees longitude, you need to offset by 7 degrees in the direction of W from the central meridian of the Central Standard Time after the calibration.

Example City: Los Angeles, USA

If you observe in Los Angeles, which is located at 118 degrees longitude, you need to offset by 3 degrees in the direction of E from the central meridian of the Pacific Standard Time after the calibration.

- 10 Match the date graduation circle with your local observing time by rotating the polar axis scope. The figure below shows 21h 42m on December 20th. The time graduation circle has a scale in 10-minute increments, but you may set it as fine as one minute.

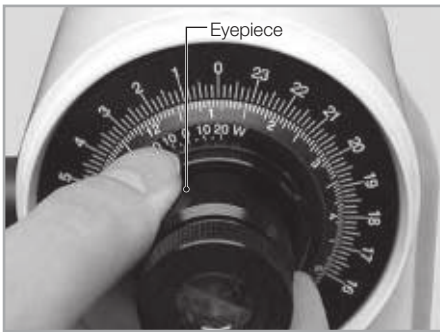

- 11 While looking into the eyepiece of the polar axis scope, turn the azimuth adjustment knobs and the altitude adjustment knob alternately so that Polaris comes to the position in the reticle as shown in the figure. Readjust the brightness of the reticle to be dimmer if necessary.

**Note :** The position of the celestial poles moves gradually each year due to precession. According to this, the position of Polaris shifts every year.

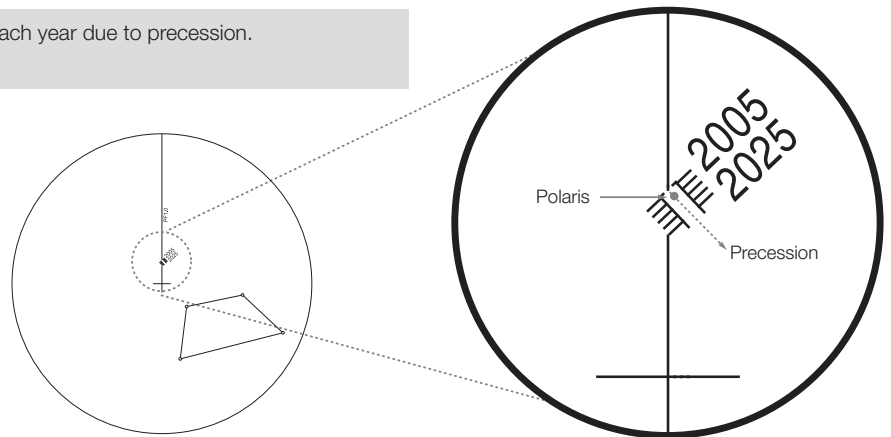

- 12 Unfastening one side of the azimuth adjustment knobs will allow fastening the knob on the other side.



- 13 Turn the altitude adjustment knob.



- 14 Tighten the azimuth adjustment knobs and altitude adjustment knob securely and complete the polar alignment.

Polar Alignment in the Southern Hemisphere

Octans is a constellation located near the south celestial pole and it can be used to align the Polaris in the southern hemisphere. Unlike Polaris which is a bright 2nd magnitude star adjacent to the north celestial pole, Octans is made up of dark stars about 5th magnitude on average. The nearest star to the south celestial pole is Sigma Octantis, which is one of four stars forming a trapezoid in Octans, visible at 5.5th magnitude. There are a few methods to locate inconspicuous Octans using the surrounding stars.

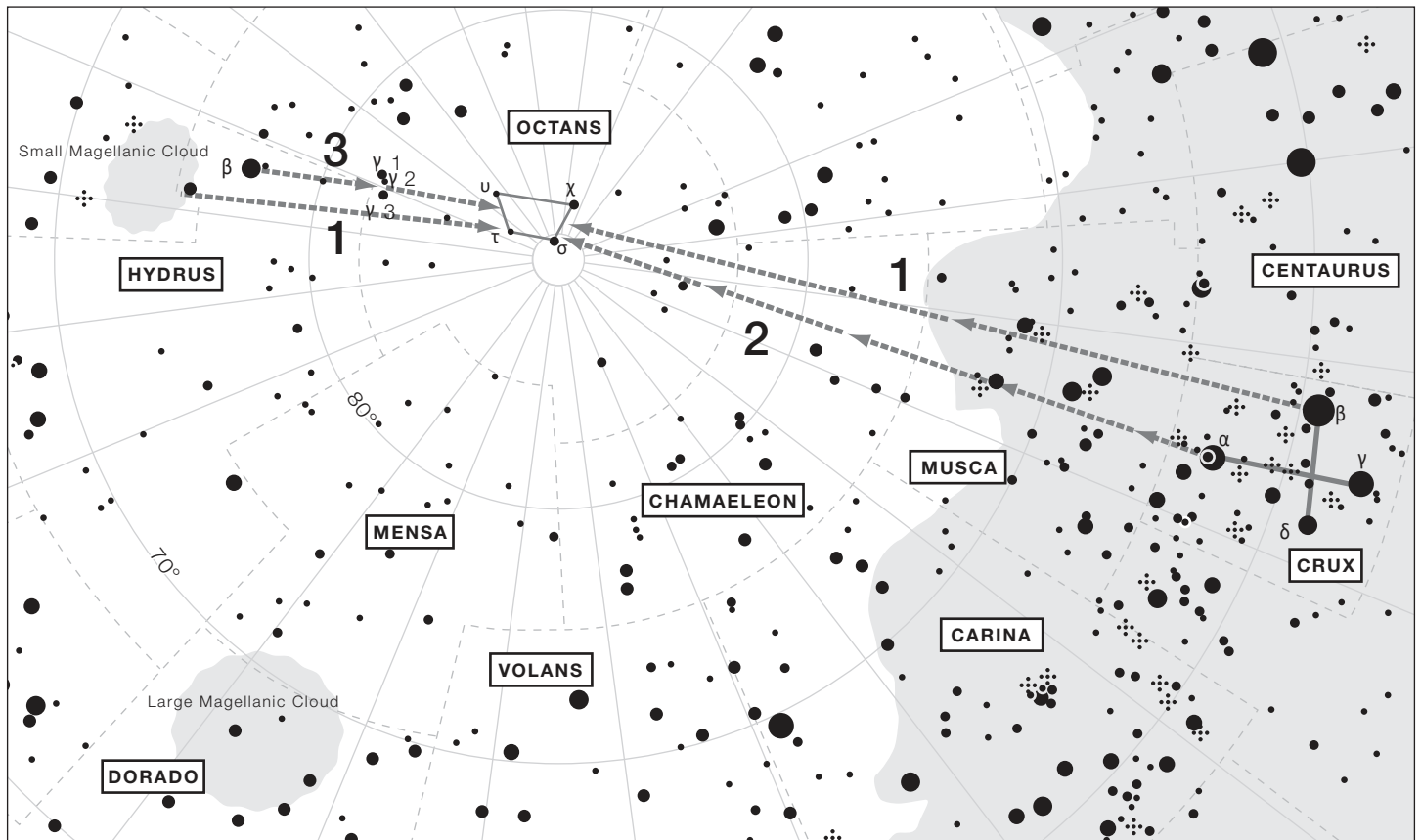

**Note :** The orientation of the Octans changes depending on the season of year.

**1. Directing to the Octans using Small Magellanic Cloud and the Southern Cross (Crux) as pointers**

Draw an imaginary line between the center of Small Magellanic Cloud and Beta Crux and divide it at a ratio of one to two. You will find the four stars of Octans at the divide.

**2. Directing to the Octans using the arrangement of stars in the Southern Cross (Crux) as pointers**

Draw an imaginary line straight through the two stars (Alpha and Beta Crux) of the Southern Cross making the vertical line of the cross toward Small Magellanic Cloud. You will find the four stars of Octans at a place about 4.5 times extended from the span of the two stars.

**3. Directing the Octans using Small Magellanic Cloud, Beta Hydrus and Gamma Octantis as pointers**

If you cast your eyes a little toward Crux from Small Magellanic Cloud, you will see Beta Hydrus. Going southward from Beta Hydrus will find you Gamma Octans which consists of a row of three stars. Continue on your eyes by the same distance toward the Southern Cross and you will find the four stars of Octans.

## Chapter 5 APPLICATION

The polar axis scope contains a reticle showing the relative positions of four stars near the southern celestial pole. The stars are Sigma, Tau, Chi and Upsilon of Octans. Polar align the mount with these four stars but precession is not considered.

- 1 Set up the telescope in a flat and hard ground where you can see Octans in the sky. Point the polar axis of the SXD2 mount in the direction of south.  
Adjust the tripod legs so that the tripod is as level as possible.
- 2 Take off the declination cap and polar axis cap. These caps can be removed readily by twisting counter-clockwise.
- 3 Turn on the power switch of the mount and advance the initial settings until the telescope's home position screen appears on the screen of the STAR BOOK TEN.
- 4 Refer to set up procedures 4 to 7 that are described for the use in the northern hemisphere.



- 5 While looking into the eyepiece of the polar axis scope, turn the azimuth adjustment screws and the altitude adjustment screw alternately so that the four stars of Octans comes into the field of view of the polar axis scope. Readjust the brightness of the reticle to be dimmer if necessary.

Octantis	Magnitude
$\sigma$ (Sigma)	5.5
$\chi$ (Chi)	5.2
$\tau$ (Tau)	5.6
$\upsilon$ (Upsilon)	5.7

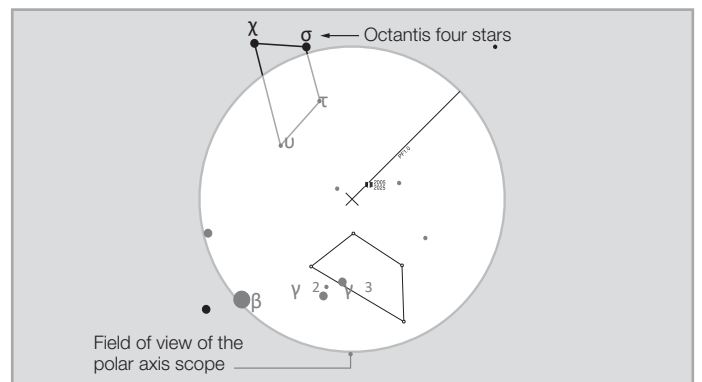

- 6 While looking into the eyepiece of the polar axis scope, rotate the polar axis scope so that the four stars of Octans comes to the position in the reticle as shown in the figure.

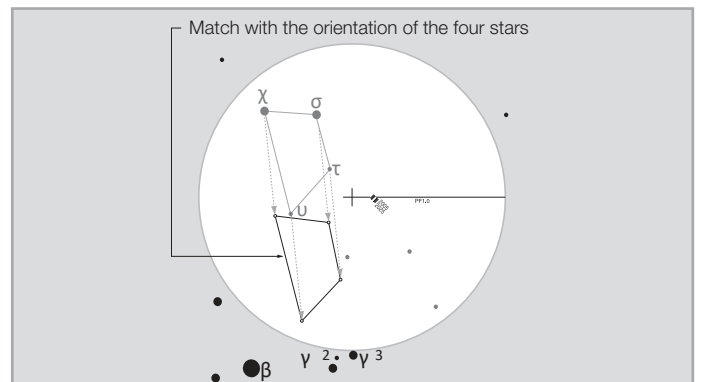

- 7 Match the form of the Octantis four stars on the reticle with the four stars of Octans while looking through the polar axis scope.

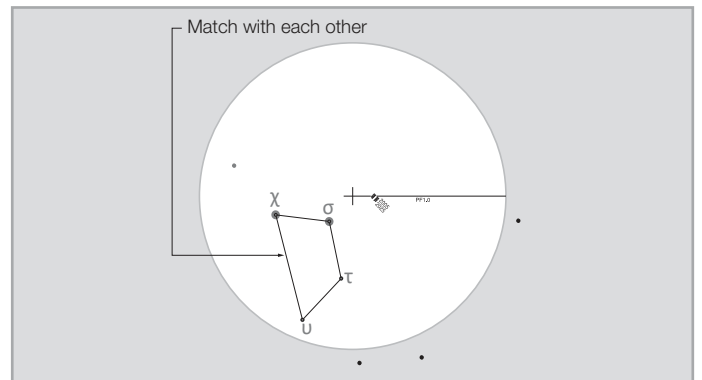

**Note :** The position of the celestial poles moves gradually each year due to precession. According to this, the pattern of Octans shifts every year.



## Chapter 5 APPLICATION

### Precise Polar Alignment (Drift Alignment)

If you align the mount with the provided polar alignment scope correctly, the mount will be able maintain tracking celestial objects within the field of view of your telescope's eyepiece. For astrophotography, it enables you to take exposures of 5 to 10 minutes with a telephoto lens of 200mm focal length or less.

However, if you want to take longer exposures than 10 minutes or use a telephoto lens of longer focal length than 200mm, more precise polar alignment is required. The following method of polar adjustment will be done by watching the movement of a bright star in the eyepiece and it is called drift alignment.

### CAUTION

Refrain from doing the star alignment with the STAR BOOK TEN if you need to perform the drift alignment. If the mount type is chosen as „Equatorial mount without polar setting“, the position information collected by the star alignment will be applied for the polar alignment. This will spoil the drift alignment as any drifts from the celestial pole are detected and corrected automatically. Choose „Equatorial mount with polar setting“ to avoid these corrections. Also turn off the function of depressing atmospheric refractions.

### Drift Alignment in the Northern Hemisphere

1 Align the mount to the north celestial pole by using the polar axis scope. This will save time during the process of drift alignment.

2 Align the Mount in Azimuth  
Prepare an eyepiece with illuminated reticle (cross hairs) or you use a Vixen OR12.5mm with illuminated reticle. Choose a bright star near the celestial equator and near the meridian, and put it in the field of view of the eyepiece. Turn off the power switch of the mount momentarily while looking into the eyepiece to see which direction the star moves. Confirm the west and rotate the eyepiece so that one of the cross hairs is parallel to the east-west direction in the field of view. The figure on the right shows the directions of north, south, east and west in the eyepiece according to a type of your telescope with or without a star diagonal.

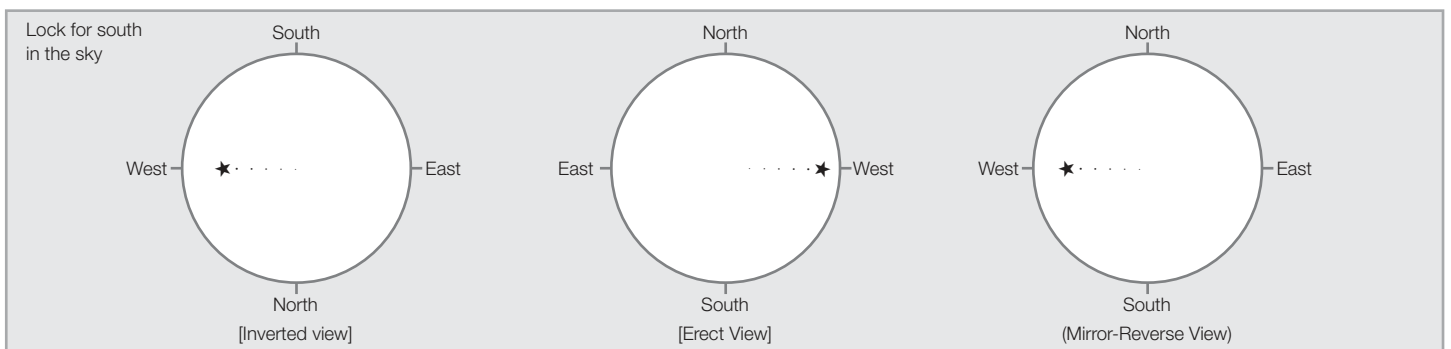

The following descriptions are based on a telescope without a star diagonal.

Drive the mount at sidereal rate and look into the eyepiece to monitor the drift motion of the star in the north-south direction.

If the star drifts north (i.e. moves down due to inverted view), move the mount to east in azimuth.

If the star drifts south (i.e. moves up due to inverted view), move the mount to west in azimuth.

Adjust the mount with the azimuth adjustment screws. Make appropriate adjustments to the polar axis to eliminate the drift.

3 Align the Mount in Altitude  
Choose a bright star near celestial equator in east but not too low, and put it in the field of view of the eyepiece. Turn off the power switch of the mount momentarily while looking into the eyepiece to see in which direction the star moves. Confirm the west and rotate the eyepiece so that one of the cross hairs is parallel to the east-west direction in the field of view. The figure on the right shows the directions of north, south, east and west in the eyepiece according to a type of your telescope with or without a star diagonal.

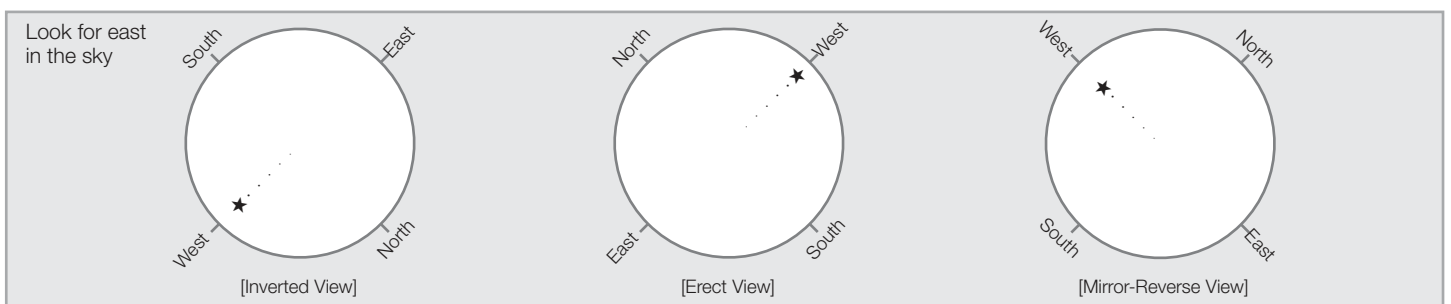

The following descriptions are based on a telescope without a star diagonal.

Drive the mount at sidereal rate and look into the eyepiece to monitor a drift motion of the star in the north-south direction.

If the star drifts south (i.e. moves toward the lower left due to inverted view), move the mount to low in altitude.

If the star drifts north (i.e. moves toward the upper right to inverted view), move the mount to high in altitude.

Adjust the mount with the altitude adjustment screws. Make appropriate adjustments to the polar axis to eliminate the drift.

## Chapter 5 APPLICATION

### Drift Alignment in the Southern Hemisphere

Align the mount to the south celestial pole by using the polar axis scope. It will save you a lot of time in the process of drift alignment.

#### 1 Align the Mount in Azimuth

Prepare an eyepiece with illuminated reticle (cross hairs) or you use a Vixen OR12.5mm with illuminated reticle. Choose a bright star near the celestial equator and near the meridian, and put it in the field of view of the eyepiece. Turn off the power switch of the mount momentarily while looking into the eyepiece to see which direction the star moves. Confirm the west and rotate the eyepiece so that one of the cross hairs is parallel to the east-west direction in the field of view.

The following descriptions are based on a telescope without a star diagonal.

Drive the mount at sidereal rate and look into the eyepiece to monitor the drift motion of the star in the north-south direction.

If the star drifts south (i.e. moves down due to inverted view), move the mount to east in azimuth.

If the star drifts north (i.e. moves up due to inverted view), move the mount to west in azimuth.

Adjust the mount with the azimuth adjustment screws. Make appropriate adjustments to the polar axis to eliminate the drift.

#### 2 Align the Mount in Altitude

Choose a bright star in east but not too low, and put it in the field of view of the eyepiece. Turn off the power switch of the mount momentarily while looking into the eyepiece to see in which direction the star moves. Confirm the west and rotate the eyepiece so that one of the cross hairs is parallel to the east-west direction in the field of view.

The following descriptions are based on a telescope without a star diagonal.

Drive the mount at sidereal rate and look into the eyepiece to monitor a drift motion of the star in the north-south direction.

If the star drifts south (i.e. moves toward the lower left due to inverted view), move the mount to low in altitude.

If the star drifts north (i.e. moves toward the upper right to inverted view), move the mount to high in altitude.

Adjust the mount with the altitude adjustment screws. Make appropriate adjustments to the polar axis to eliminate the drift

### Change the Altitude Setting on the SXD2 Mount

The SXD2 mount is set for use in the middle latitude zone (latitude of 35 degrees plus/minus 15 degrees) at Vixen's factory. If your observing site is lower or higher than the range of the middle latitude zone, you need to change the current altitude setting to match the latitude of your observing site. The range of altitude adjustments is divided into three positions (low, middle and high) between 0 degrees and 70 degrees in latitude.

<b>High Latitude</b>	<b>: 40 degrees up to 70 degrees</b>
<b>Middle Latitude</b>	<b>: 20 degrees up to 40 degrees</b>
<b>Low latitude</b>	<b>: 0 degree up to 30 degrees</b>

1 Remove the optical tube and the counterweights from the mount.

2 Loosen the altitude clamp lever on one side of the mount body where no altitude scale is attached, and turn the altitude adjustment knob so that the altitude of the mount comes to a position of 35 degrees. Then, tighten the altitude clamp lever.

3 Loosen a bolt beneath the altitude clamp lever with the 5mm Allen wrench and remove it.

4 Loosen the altitude clamp lever while holding the mount head with the other hand so that the mount body is moved slowly to high or low position in altitude.

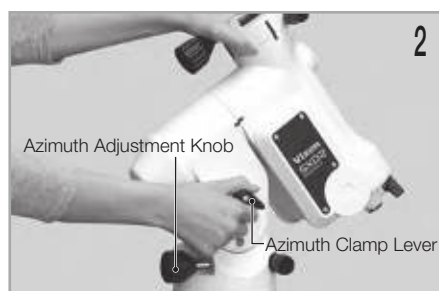

5 Move the mount to a position of 55 degrees in altitude if you use the mount in the range of high latitude. Or move the mount to a position of 15 degrees in altitude if you use the mount in the range of low latitude. Tighten the altitude clamp lever.

6 Put back the bolt in place and tighten it with the Allen wrench securely.

7 Loosen the altitude clamp lever again and turn the altitude adjustment knob so that the mount is set at the latitude of your observing site.



8 Tighten the altitude clamp lever and the setting is completed.

### CAUTION

Never tilt the mount body quickly. It may result in damage or lead to injury.

## Chapter 5 APPLICATION

### II . INITIAL CONFIGURATION (Main screen right after turning ON the power)

This allows you to choose the settings for various functions including time and location.

#### Use Last Mount Setting

This allows you to continue using the SXD2 mount with the same settings you used during your last observing session. If you choose this option, the STAR BOOK TEN retains its alignment data while the mount is powered off. When you use the mount next time, you will be able to start Go-To slewing and observing quickly without the routine alignment works.

**The setting is defaulted to „OFF“.**

1 In the “Initial Configuration” menu, choose “Use Last Mount Setting” with the  $\uparrow$  or  $\downarrow$  direction key and press the  $\text{ENTER}$  key (or the  $\rightarrow$  key) to call up the dialog box.

2 In the “Use Last Mount Setting” dialog box, choose OK with the  $\uparrow$  or  $\downarrow$  direction key and press the  $\text{ENTER}$  key to advance.

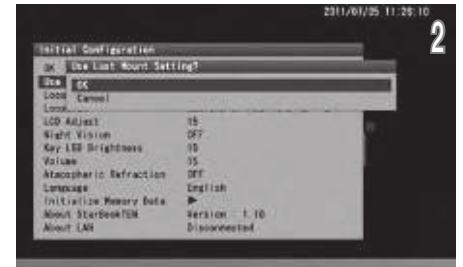
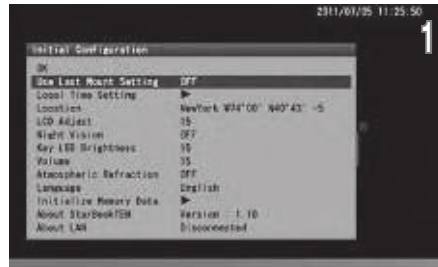

If you return to the “Initial Configuration” menu from the “Solar Warning” screen, just press the  $\text{MENU}$  key.

#### Important Note

To make the “Use Last Mount Setting” available, make sure to follow instructions below when you finish your observing session.

- \* Never move the telescope.
- \* Never loosen the lock clamps.
- \* Do not change the positions of equipment and instruments attached on the mount, and do not remove them from the mount.
- \* Do not remove the battery from the STAR BOOK TEN.

The following settings are not saved.

- \* The target just before turning off the power switch.
- \* Setting of the LCD adjustment (Initialized).
- \* Zoom level that is displayed on the screen.

#### Setting Local Time

Refer to Chapter 2 Initial Setting.

#### Setting Location

Refer to Chapter 2 Initial Setting.

#### LCD Adjustment

The brightness of the LCD screen can be adjusted from 0 to 20, i.e. “off to the brightest” divided by 20 steps.

**The setting is defaulted to „15“.**

1 In the “Initial Configuration” menu, choose “LCD Adjust” with the  $\uparrow$  or  $\downarrow$  direction key and press the  $\text{ENTER}$  key (or the  $\rightarrow$  key) to call up the dialog box.

2 In the “LCD Adjust” dialog box, enter your desired value between 0 and 20 by number with the  $\uparrow$  or  $\downarrow$  direction key and pressing the  $\text{ENTER}$  key will shift the cursor to OK.

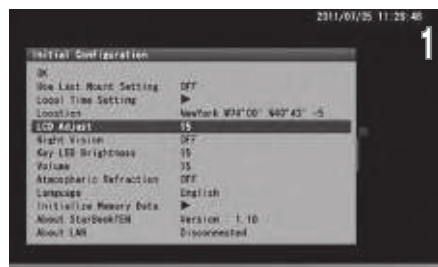

The setting is returned to the default and not saved when you turn off the STAR BOOK TEN.

Then, press the  $\text{ENTER}$  key again to save and leave the dialog box.

You can also access the “LCD Adjust” dialog box from “System Menu”.

**Note:** Using the zoom key will shift the cursor on the screen every five lines.

## Chapter 5 APPLICATION

### Night Vision

To maintain your night vision, avoid white light. The “Night Vision” mode of the SXD2 mount turns the screen from the bright “white color” to gentle “red color”. You can use it together with the “LCD Adjust” for the best accommodation to your eyes.

**The setting is defaulted to „OFF“.**

1 In the “Initial Configuration” menu, choose “Night Vision” with the  $\uparrow$  or  $\downarrow$  direction key and press the  $\text{ENTER}$  key (or the  $\rightarrow$  key) to call up the dialog box.

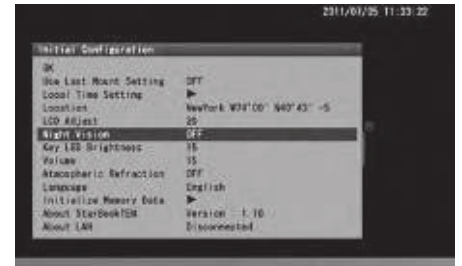

2 Choose ON with the  $\uparrow$  or  $\downarrow$  direction key and press the  $\text{ENTER}$  key to activate the “Night Vision” screen.

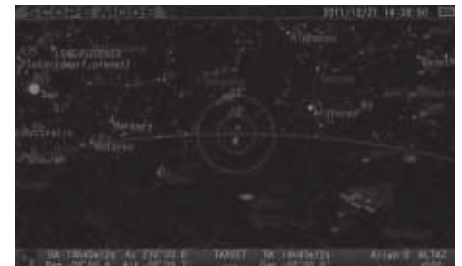
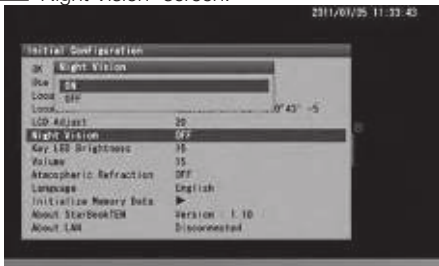

Examples of Night vision screens

**Note:** You can also access the “Night Vision” dialog box from “System Menu”.

### Key LED Brightness

The brightness of the backlight LED for the keys can be adjusted from 0 to 20, i.e. “off to the brightest” divided by 20 steps.

**The setting is defaulted to „15“.**

1 In the “Initial Configuration” menu, choose “Key LED Brightness” with the  $\uparrow$  or  $\downarrow$  direction key and press the  $\text{ENTER}$  key (or the  $\rightarrow$  key) to call up the dialog box.



2 In the “Key LED Brightness” dialog box, enter your desired value between 0 and 20 with the  $\uparrow$  or  $\downarrow$  key and pressing the  $\text{ENTER}$  key will shift the cursor to OK.



The setting is returned to the default and not saved when you turn off the STAR BOOK TEN. Then, press the  $\text{ENTER}$  key again to save and leave the dialog box.

**Note:** You can also access the “Key LED Brightness” dialog box from “System Menu”.

## Chapter 5 APPLICATION

### Volume

The volume of the chimes can be adjusted from 0 to 20, i.e. “off to the loudest” divided by 20 steps.

**The setting is defaulted to „15“.**

- 1 In the “Initial Configuration” menu, choose “Volume” with the  $\uparrow$  or  $\downarrow$  direction key and press the  $\text{ENTER}$  key (or the  $\rightarrow$  key) to call up the dialog box.



- 2 In the “Volume” dialog box, enter your desired value between 0 and 20 with the  $\uparrow$  or  $\downarrow$  direction key. Pressing the  $\text{ENTER}$  key will shift the cursor to OK. Then, press the  $\text{ENTER}$  key again to save and leave the dialog box.

- 3 Pressing the  $\rightarrow$  key will allow you to listen to the chimes to confirm the loudness.

**Note:** You can also access the “Volume” dialog box from “System Menu”.



### Atmospheric Refraction

The celestial light coming from outside of the earth refracts at the atmosphere and causes displacement of celestial objects. It is called atmospheric refraction. The atmospheric refraction increases near the horizon, decreases as the altitude of celestial objects rise, and diminishes at the zenith. The „Atmospheric Refraction“ setting allows you to compensate or diminish the affect of the atmospheric refraction to the celestial objects near the horizon.

It is recommended to choose OFF in the „Atmospheric Refraction“ dialog box if you use an autoguider.

**The setting is defaulted to „OFF“.**

- 1 In the “Initial Configuration” menu, choose “Atmospheric Refraction” with the  $\uparrow$  or  $\downarrow$  direction key and press the  $\text{ENTER}$  key (or the  $\rightarrow$  key) to call up the dialog box.



- 2 In the “Atmospheric Refraction” dialog box, choose ON with the  $\uparrow$  or  $\downarrow$  direction key and press the key.

**Note:** You can also access the “Atmospheric Refraction” dialog box from “System Menu”.

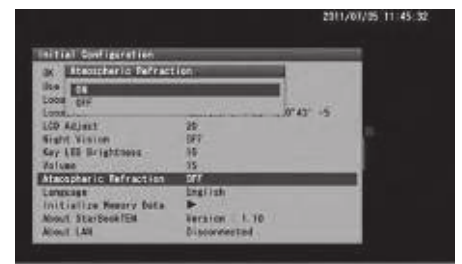

## Chapter 5 APPLICATION

### Language

Language is available in Japanese, English, Germany, Italian, Spanish and French on the STAR BOOK TEN as of October 2017.

#### The setting is defaulted to „Japanese“.

- 1 In the “Initial Configuration” menu, choose “Language” with the  $\uparrow$  or  $\downarrow$  direction key and press the  $\text{ENTER}$  key (or the  $\rightarrow$  key) to call up the dialog box.



- 2 In the “Language” dialog box, choose your language from English, Germany, Italian, Spanish and French with the  $\uparrow$  or  $\downarrow$  direction key and press the  $\text{ENTER}$  key.



**Note:** You can also access the “Language” dialog box from “System Menu”.

### Initialize Memory Data

Choose this option to clear all memory including the user defined menu items and setup menu settings. Use it with caution. Local time setting is not cleared.

- 1 In the “Initial Configuration” menu, choose “Initialize Memory Data” with the  $\uparrow$  or  $\downarrow$  direction and press the  $\text{ENTER}$  key (or the  $\rightarrow$  key) to call up the dialog box.

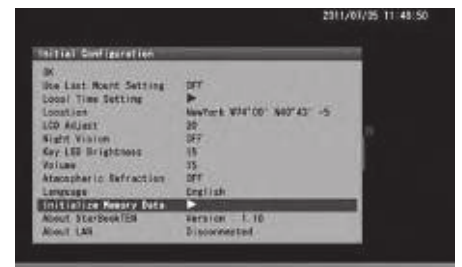

- 2 In the “Initialize Memory Data” dialog box, choose OK with the  $\uparrow$  or  $\downarrow$  direction key and press the  $\text{ENTER}$  key.



**Note:** You can also access the “Initialize Memory Data” dialog box from “System Menu”.

## Chapter 5 APPLICATION

### About StarBook TEN

This allows you to access the program version, IP address and MAC address of your STAR BOOK TEN controller. This information is required for program updates and downloads from a PC through a local area network.

- 1 In the “Initial Configuration” menu, choose “About StarBook TEN” with the  $\uparrow$  or  $\downarrow$  direction key and press the  $\text{ENTER}$  key (or the  $\rightarrow$  key) to display the information screen of “About STAR BOOK TEN”.



- 2 “About STAR BOOK TEN” screen is displayed.

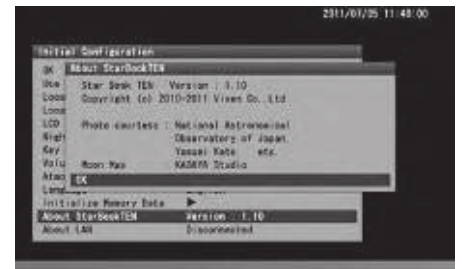

- 3 Press the  $\text{ENTER}$  key (or the  $\rightarrow$  key) to close the information screen.

**Note:** You can also access the “About StarBook TEN” dialog box from “System Menu”.

### About LAN

You can confirm “IP address” and “MAC address” either on the “Initial Configuration” screen or from “System Menu”.

- 1 In the “Initial Configuration” menu, choose “About LAN” with the  $\uparrow$  or  $\downarrow$  direction keys and press the  $\text{ENTER}$  key (or the  $\rightarrow$  key) to display the information screen of “About LAN”.



- 2 “About LAN” screen is displayed.

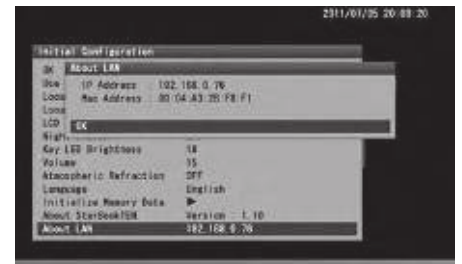

On the information screen, IP address does not appear until a connection to LAN is completed, or if the LAN is disconnected.



- 3 Press the  $\text{ENTER}$  key (or the  $\leftarrow$  key or  $\text{CLEAR}$  key) to close the information screen.

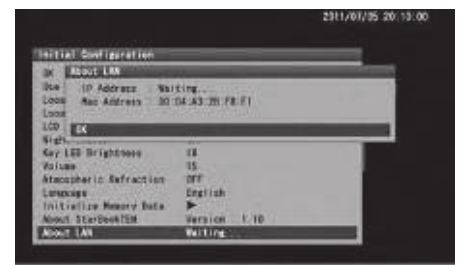

**Note:** You can also access the “About LAN” dialog box from “System Menu”.

## Chapter 5 APPLICATION

### III. System Menu (Main Menu)

Choose the settings for various functions to suite your preference. Press the **0** MENU key to call up "System Menu".

#### Chart Setting

This menu allows various display settings on the star charts.

1 In "System Menu", choose "Chart Setting" with the **▲** or **▼** direction key and press the **ENTER** key (or the **▶** key) to call up the "Chart Setting" menu.

2 The "Chart Setting" dialog box appears.

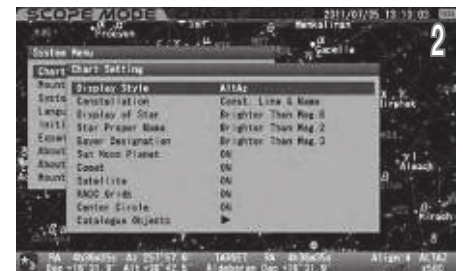

#### Display Style

The orientation of star charts can be chosen from the AltAz (where star charts are displayed so that the horizontal is parallel to azimuth direction) or RADEC (where star charts are displayed so that the horizontal is parallel to R.A direction)

#### The setting is defaulted to „AltAz“

1 In the "Chart Setting" menu, choose "Display Style" with the **▲** or **▼** direction key and press the **ENTER** key (or the **▶** key) to call up the dialog box

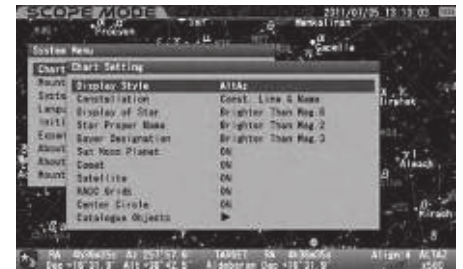

2 In the "Display Style" dialog box, choose your desired option with the **▲** or **▼** direction key. Press the **ENTER** key (or the **▶** key) to save and leave the dialog box.

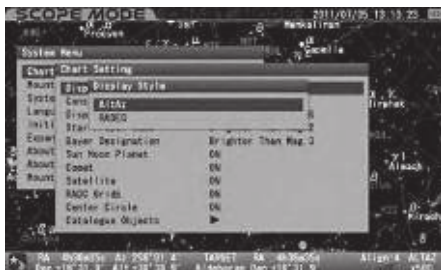

Example: Set to „Alt-Az“



Example: Set to „RA-DEC“

#### Calling up the „Display Style“ dialog box directly

The "Display Style" dialog box appears on the screen if you press the **3** R/A key a little longer in both SCOPE MODE and CHART MODE.

Choose any of the following display styles as the occasion demands.

##### AltAz:

In the AltAz mode, the telescope moves horizontally or vertically when the direction keys are pressed. This mode makes it easy to follow an object into the finder's field of view.

##### RADEC:

In the RADEC mode, the telescope moves along the R.A /DEC in celestial coordinates, even if the polar axis is not aligned.

##### X-Y:

In the X-Y mode, the direction keys control the motors individually. This mode is suited for fine control of the telescope. If the polar axis is aligned accurately, then the X-Y mode and RADEC mode are almost the same. However, when you press the **▲** direction key (UP), the telescope will move over and across the pole in the X-Y mode.

Pressing the **◀** key or **CLEAR** key will cancel the operation.





# Chapter 5 APPLICATION

## Constellation

This allows you to choose your preference for the display of the constellations from the following options.

- OFF: Neither constellation lines, names nor its aberrations are displayed.
- Const. Line: Only constellation lines are displayed.
- Const. Name: Only constellation names are displayed.
- Const. Line & Name: Lines and names of constellations are displayed.
- Const. Abbr.: Only abbreviated constellation names are displayed.
- Const. Line & Abbr.: Lines and abbreviated name of constellations are displayed.
- Const. Name & Abbr.: Constellation names and its abbreviations are displayed.
- Const. Line, Name & Abbr.: All of constellation lines, names and its aberrations are displayed.

### The setting is defaulted to „Const. Line & Name“

1 In the “Chart Setting” menu, choose “Constellation” with the  $\uparrow$  or  $\downarrow$  direction key and press the  $\text{ENTER}$  key (or the  $\rightarrow$  key) to call up the dialog box.

2 In the “Constellation” dialog box, choose your desired option with the  $\uparrow$  or  $\downarrow$  direction key.

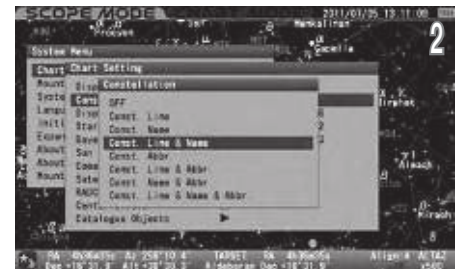

Press the  $\text{ENTER}$  key (or the  $\rightarrow$  key) to save and leave the dialog box.

Set to „OFF“

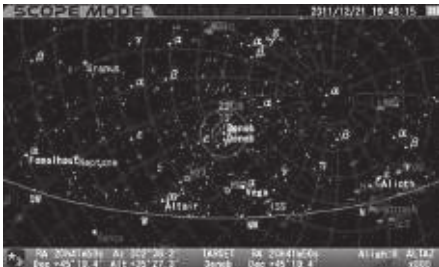

Set to “Const. Line”

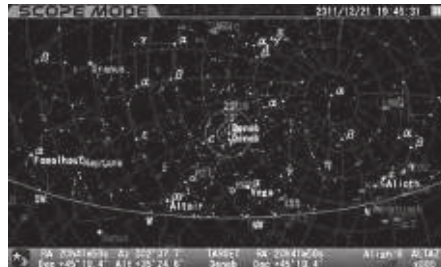

Set to “Const. Name”

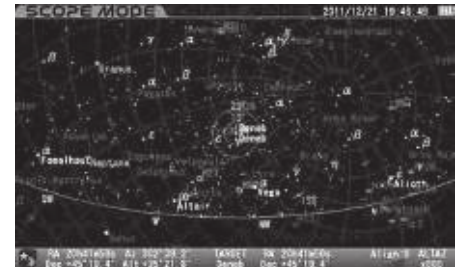

Set to “Const. Line & Name”

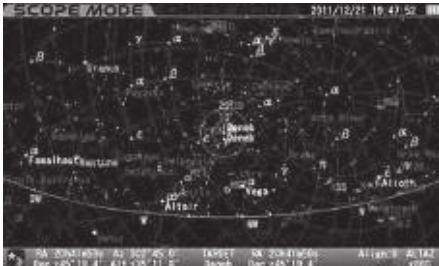

Set to “Const. Abbr.”

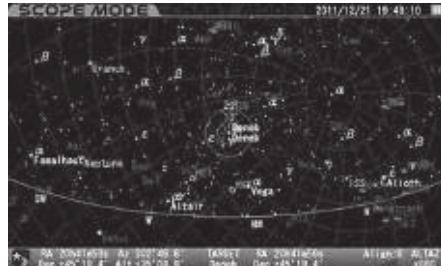

Set to “Const. Line & Abbr.”

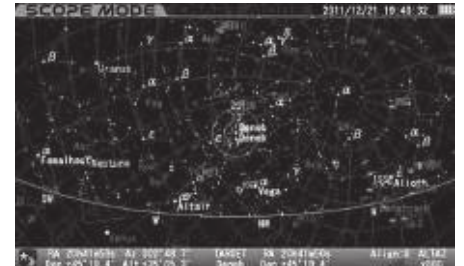

Set to “Const. Name & Abbr.”

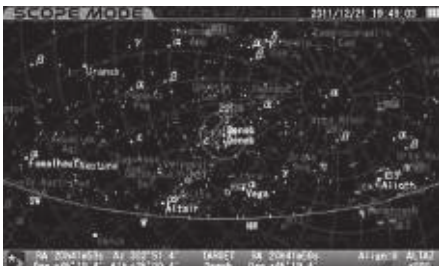

Set to “Const. Line, Name & Abbr.”

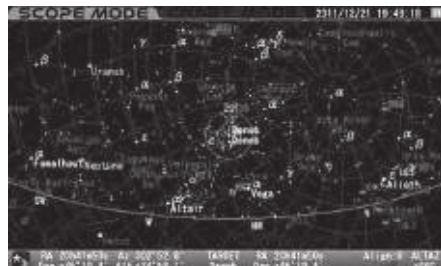

## Chapter 5 APPLICATION

### Display of Star

This allows you to limit the number of fixed stars displayed on the star chart by magnitude at the widest chart so that you can prevent the screen from being full of luminous stars.

**Brighter than Mag.8 :** Fixed stars of 8th magnitude and brighter are displayed.

**Brighter than Mag.7 :** Fixed stars of 7th magnitude and brighter are displayed.

**Brighter than Mag.6 :** Fixed stars of 6th magnitude and brighter are displayed.

**Brighter than Mag.5 :** Fixed stars of 5th magnitude and brighter are displayed.

**Brighter than Mag.4 :** Fixed stars of 4th magnitude and brighter are displayed.

The number of the fixed stars is increased up to brighter than 9th magnitude approximately as you zoom in the screen. (The magnitude of the dimmest stars shown is pre-allocated uniformly in proportion to the level of zooming in or out the screen)

### The setting is defaulted to „Brighter than Mag. 6“

1 In the “Chart Setting” menu, choose “Display of Star” with the  $\uparrow$  or  $\downarrow$  direction key and press the  $\text{ENTER}$  key (or the  $\rightarrow$  key) to call up the dialog box.

2 In the “Display of Star” dialog box, choose your desired option with the  $\uparrow$  or  $\downarrow$  direction key.

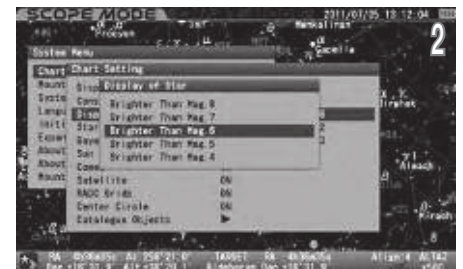
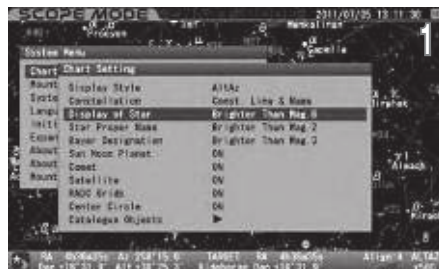

Press the  $\text{ENTER}$  key (or the  $\leftarrow$  key) to save and leave the dialog box.

Example: Set to „Brighter than Mag.5“

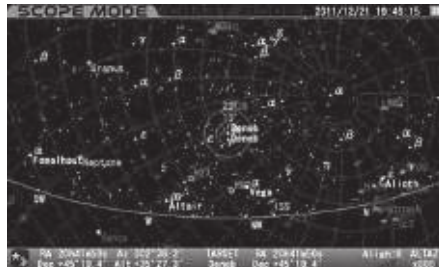

Example: Set to „Brighter than Mag.7“

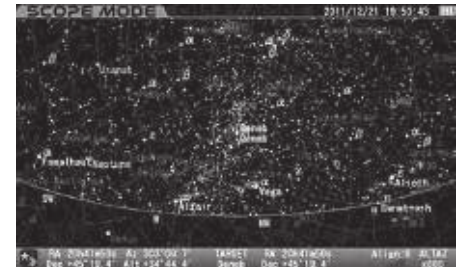

## Chapter 5 APPLICATION

### Star Proper Name

This allows you to limit the name of fixed stars displayed on the star chart by magnitude at the widest chart. Also, "Always ON" or "Always OFF" is available.

**Always ON** : Names are always indicated.

**Brighter than Mag.5** : Names of fixed stars of 5th magnitude and brighter are displayed.

**Brighter than Mag.4** : Names of fixed stars of 4th magnitude and brighter are displayed.

**Brighter than Mag.3** : Names of fixed stars of 3rd magnitude and brighter are displayed.

**Brighter than Mag.2** : Names of fixed stars of 2nd magnitude and brighter are displayed.

**Brighter than Mag.1** : Names of fixed stars of 1st magnitude and brighter are displayed.

**Always OFF** : Names are always hidden.

The number of the name of the fixed stars is increased as you zoom in the screen.

### The setting is defaulted to „Brighter than Mag. 2“

1 In the "Chart Setting" menu, choose "Star Proper Name" with the  $\uparrow$  or  $\downarrow$  direction key and press the  $\text{ENTER}$  key (or the  $\rightarrow$  key) to call up the dialog box.



2 In the "Star Proper Name" dialog box, choose your desired option with the  $\uparrow$  or  $\downarrow$  direction key.

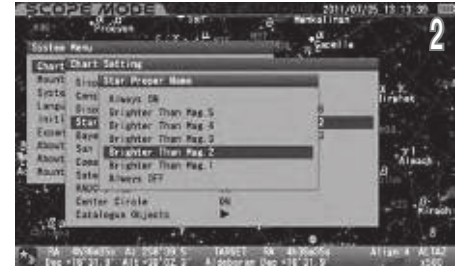

Press the  $\text{ENTER}$  key (or the  $\leftarrow$  key) to save and leave the dialog box.

Example: Set to „Brighter than Mag.2“

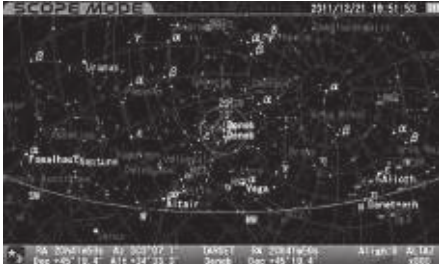

Example: Set to „Brighter than Mag.3“

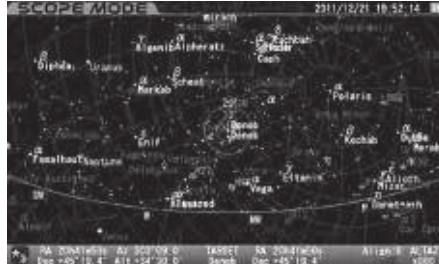

Example: Set to „Always OFF“

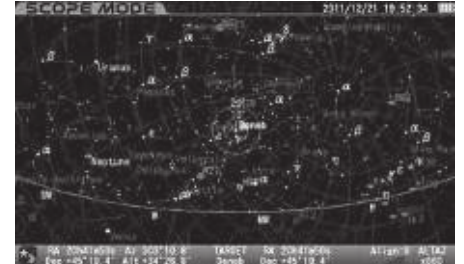

## Chapter 5 APPLICATION

### Bayer Designation

This allows you to limit Bayer designation of fixed stars displayed on the star chart by magnitude at the widest chart. Also, "Always ON" or "Always OFF" is available.

**Always ON:** Bayer designation of fixed stars is always indicated.

**Brighter than Mag.5:** Bayer designation of fixed stars of 5th magnitude and brighter are displayed.

**Brighter than Mag.4:** Bayer designation of fixed stars of 4th magnitude and brighter are displayed.

**Brighter than Mag.3:** Bayer designation of fixed stars of 3rd magnitude and brighter are displayed.

**Brighter than Mag.2:** Bayer designation of fixed stars of 2nd magnitude and brighter are displayed.

**Brighter than Mag.1:** Bayer designation of fixed stars of 1st magnitude and brighter are displayed.

**Always OFF:** Bayer designation is always hidden.

The number of Bayer designations of the fixed stars is increased as you zoom in the screen.

### The setting is defaulted to „Brighter than Mag. 3“

1 In the "Chart Setting" menu, choose "Bayer Designation" with the  $\uparrow$  or  $\downarrow$  direction key and press the  $\text{ENTER}$  key (or the  $\rightarrow$  key) to call up the dialog box.

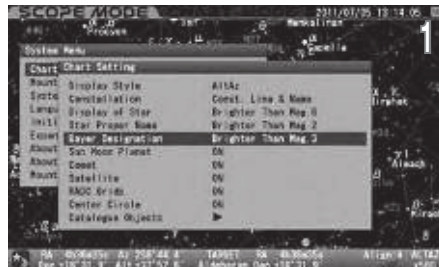

2 In the "Bayer Designation" dialog box, choose your desired option with the  $\uparrow$  or  $\downarrow$  direction key.

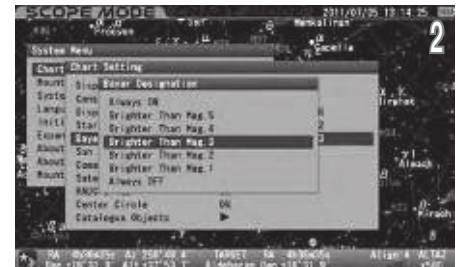

Press the  $\text{ENTER}$  key (or the  $\leftarrow$  key) to save and leave the dialog box.

Example: Set to „Brighter than Mag.1“

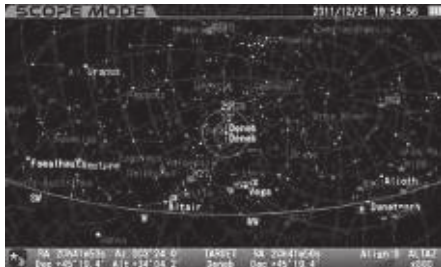

Example: Set to „Brighter than Mag.3“

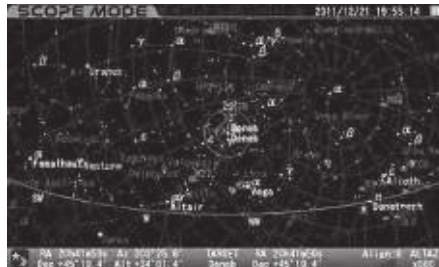

Example: Set to „Always OFF“

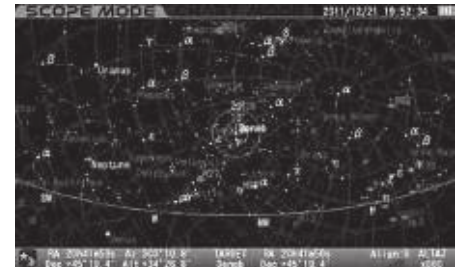

## Chapter 5 APPLICATION

### Sun • Moon • Planet

This allows you to choose your preference for the display of the name of the Sun, Moon and planets from the following options. It is not possible to hide the Sun, Moon and planets themselves.

**ON** : The names of the Sun, Moon and planets are displayed.

**OFF** : The names of the Sun, Moon and planets are hidden.

**The setting is defaulted to „ON“.**

1 In the “Chart Setting” menu, choose “Sun Moon Planet” with the  $\uparrow$  or  $\downarrow$  direction key and press the  $\text{ENTER}$  key (or the  $\rightarrow$  key) to call up the dialog box.

2 In the “Sun Moon Planet” dialog box, choose your desired option with the  $\uparrow$  or  $\downarrow$  direction key.

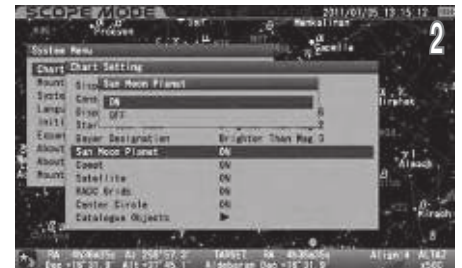
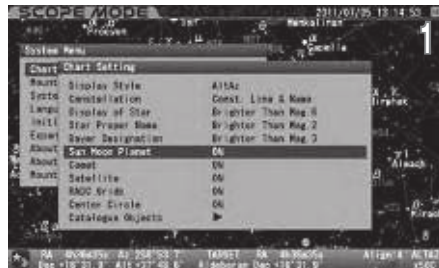

Press the  $\text{ENTER}$  key (or the  $\rightarrow$  key) to save and leave the dialog box.

Example: Set to „ON“

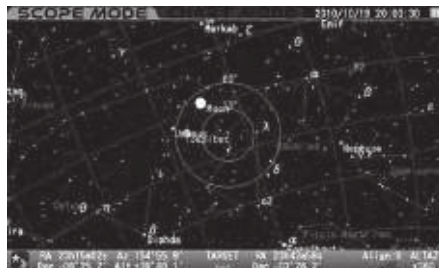

Example: Set to „OFF“

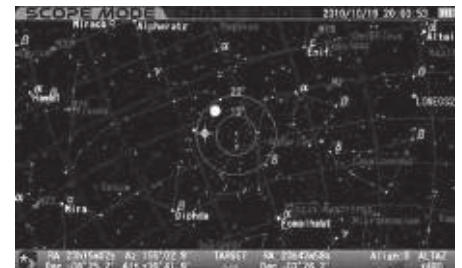

### Comet

This allows you to choose your preference for the display of comets from the following options.

**ON** : Comet is displayed.

**OFF** : Comet is hidden.

**The setting is defaulted to „ON“.**

1 In the “Chart Setting” menu, choose “Comet” with the  $\uparrow$  or  $\downarrow$  direction key and press the  $\text{ENTER}$  key (or the  $\rightarrow$  key) to call up the dialog box.

2 In the “Comet” dialog box, choose your desired option with the  $\uparrow$  or  $\downarrow$  direction key.

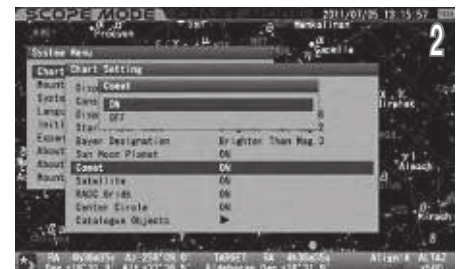
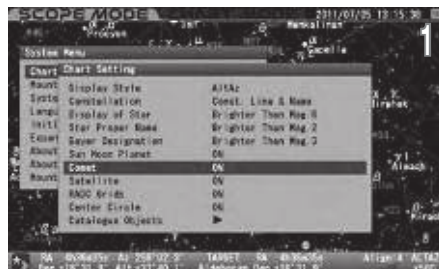

Press the  $\text{ENTER}$  key (or the  $\rightarrow$  key) to save and leave the dialog box.

Example: Set to „ON“

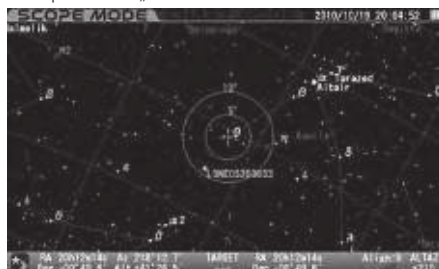

Example: Set to „OFF“



## Chapter 5 APPLICATION

### Satellite

This allows you to choose your preference for the display of Satellites from the following options.

**ON** : Satellite is displayed.

**OFF** : Satellite is hidden.

**The setting is defaulted to „ON“.**

1 In the “Chart Setting” menu, choose “Satellite” with the  $\uparrow$  or  $\downarrow$  direction key and press the  $\text{ENTER}$  key (or the  $\rightarrow$  key) to call up the dialog box.

2 In the “Satellite” dialog box, choose your desired option with the  $\uparrow$  or  $\downarrow$  direction key.

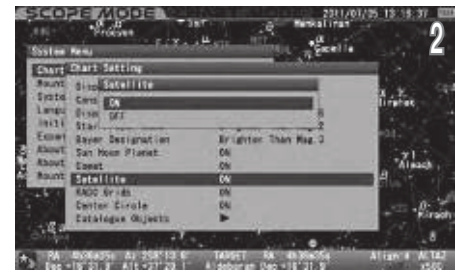
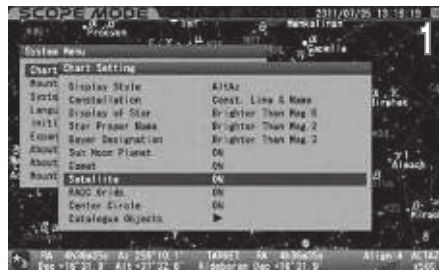

Press the  $\text{ENTER}$  key (or the  $\leftarrow$  key) to save and leave the dialog box.

Example: Set to „ON“

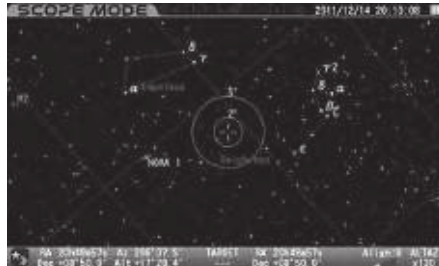

Example: Set to „OFF“



### RADEC Grids

This allows you to choose your preference for the display of RA&DEC grids from the following options.

**ON** : RA&DEC grids are displayed.

**OFF** : RA&DEC grids are hidden.

**The setting is defaulted to „ON“.**

1 In the “Chart Setting” menu, choose “RADEC Grids” with the  $\uparrow$  or  $\downarrow$  direction key and press the  $\text{ENTER}$  key (or the  $\rightarrow$  key) to call up the dialog box.

2 In the “RADEC Grids” dialog box, choose your desired option with the  $\uparrow$  or  $\downarrow$  direction key.

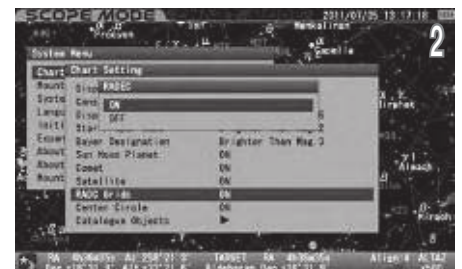
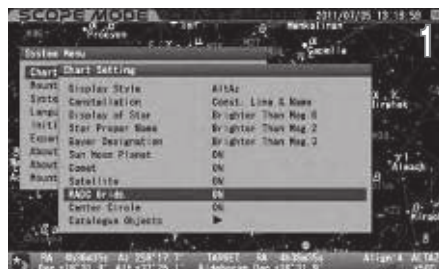

Press the  $\text{ENTER}$  key (or the  $\leftarrow$  key) to save and leave the dialog box.

Example: Set to „ON“

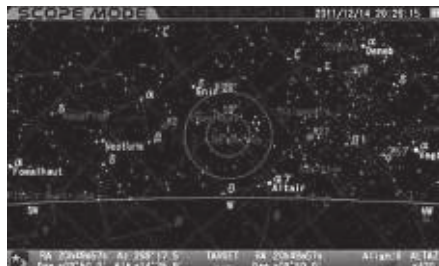

Example: Set to „OFF“

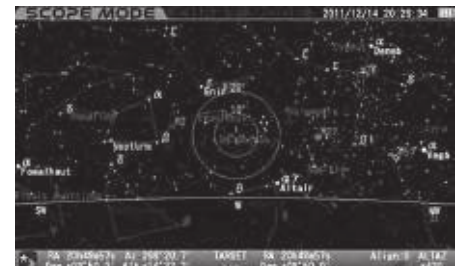

## Chapter 5 APPLICATION

### Center Circle

This allows you to choose your preference for the display of comets from the following options.

**ON** : Target circles are displayed.

**OFF** : Target circles are hidden.

**The setting is defaulted to „ON“.**

1 In the “Chart Setting” menu, choose “Center Circle” with the  $\uparrow$  or  $\downarrow$  direction key and press the  $\text{ENTER}$  key (or the  $\rightarrow$  key) to call up the dialog box.

2 In the “Center Circle” dialog box, choose your desired option with the  $\uparrow$  or  $\downarrow$  direction key.

Press the  $\text{ENTER}$  key (or the  $\leftarrow$  key) to save and leave the dialog box.

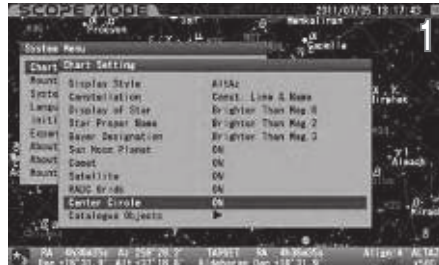

Example: Set to „ON“

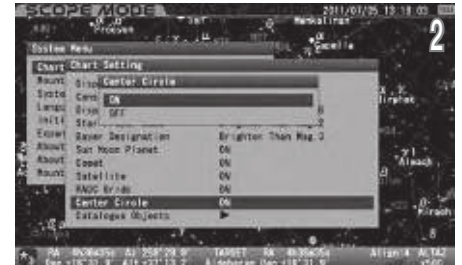
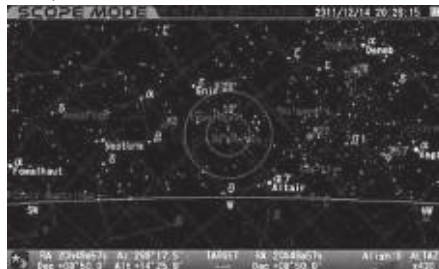

Example: Set to „OFF“

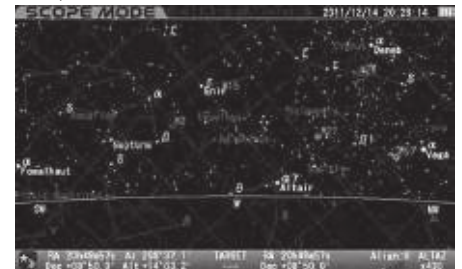

### Catalogue Objects

This allows you to choose your preference for the display of all types of deep sky objects compiled for the Messier, NGC and IC catalogues from the following options.

1 In the “Chart Setting” menu, choose “Catalogue Objects” with the  $\uparrow$  or  $\downarrow$  direction key and press the  $\text{ENTER}$  key (or the  $\rightarrow$  key) to call up the dialog box.

2 In the “Catalogue Objects” dialog box, choose your desired option with the  $\uparrow$  or  $\downarrow$  direction key and press the  $\text{ENTER}$  key.

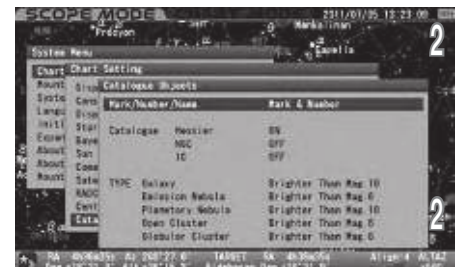

### Mark/Number/Name

**Mark** : Marks only of deep sky objects are displayed.

**Mark & Number** : Marks and numbers of deep sky objects are displayed.

**Mark & Name** : Marks and names of deep sky objects if enrolled are displayed

**Mark & Number & Name** : Marks, numbers and names of deep sky objects if enrolled are displayed

Choose “Mark/Number/Name” with the  $\uparrow$  or  $\downarrow$  direction key and press the  $\text{ENTER}$  key (or the  $\leftarrow$  key) to call up the dialog box. In the “Mark/Number/Name” dialog box, choose your preference of display with the  $\uparrow$  or  $\downarrow$  direction key and press the  $\text{ENTER}$  key.

Example: Set to „Mark“



Example: Set to „Mark&Number“



Example: Set to „Mark&Name“



Example: Set to „Mark & Number & Name“

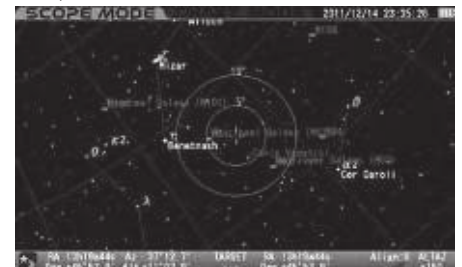

## Chapter 5 APPLICATION

### Catalogue (Messier or NGC or IC)

This allows you to choose the use of the catalogues of Messier, NGC and IC objects. All the deep sky objects from the catalogue will not appear on the star chart if it is set to OFF.

**Note:** Your target object designated is displayed even if you set this function to OFF.

**The settings are defaulted to „ON“ for Messier objects and „OFF“ for NGC and IC objects.**

1 In the “Catalogue (Messier or NGC or IC)” with the  $\uparrow$  or  $\downarrow$  direction key and press the  $\text{ENTER}$  key (or the  $\rightarrow$  key) to call up the dialog box.

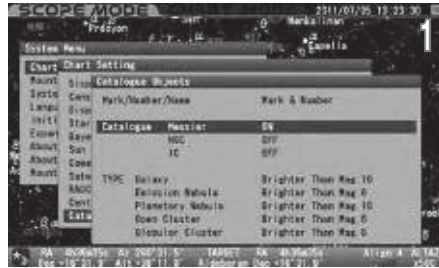

2 In the “Catalogue (Messier or NGC or IC)” dialog box, choose your preference of display with the  $\uparrow$  or  $\downarrow$  direction key and press the  $\text{ENTER}$  key.

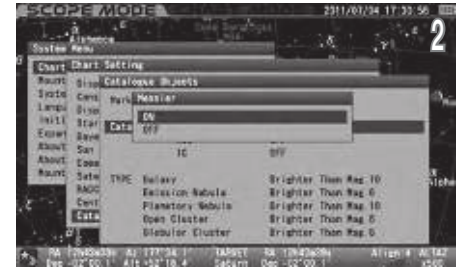

### TYPE

This allows you to limit the number of deep sky objects displayed on the star chart by magnitude, at the widest chart display, according to categories of the deep sky objects in the database.

**The settings of TYPE are defaulted to the following**

Galaxies	: Brighter than Mag.10
Emission Nebulae	: Brighter than Mag.6
Planetary Nebulae	: Brighter than Mag.10
Open Clusters	: Brighter than Mag.6
Globular Clusters	: Brighter than Mag.6

### Galaxies and Planetary Nebulas

Always ON	: The designated objects are always indicated.
Brighter than Mag.12	: Objects of 12th magnitude and brighter are displayed.
Brighter than Mag.11	: Objects of 11th magnitude and brighter are displayed.
Brighter than Mag.10	: Objects of 10th magnitude and brighter are displayed.
Brighter than Mag. 9	: Objects of 9th magnitude and brighter are displayed.
Brighter than Mag. 8	: Objects of 8th magnitude and brighter are displayed.
Always OFF	: The designated objects are always hidden.

### Emission Nebulas, Open Clusters and Globular Clusters

Always ON	: The designated objects are always indicated.
Brighter than Mag.8	: Objects of 8th magnitude and brighter are displayed.
Brighter than Mag.7	: Objects of 7th magnitude and brighter are displayed.
Brighter than Mag.6	: Objects of 6th magnitude and brighter are displayed.
Brighter than Mag.5	: Objects of 5th magnitude and brighter are displayed.
Brighter than Mag.4	: Objects of 4th magnitude and brighter are displayed.
Always OFF	: The designated objects are always hidden.

Choose a category of the deep sky objects from the “TYPE” shown in “Catalogue Objects” with the  $\uparrow$  or  $\downarrow$  direction key and press the  $\text{ENTER}$  key (or the  $\leftarrow$  key) to call up the dialog box. In each of the dialog boxes, choose your preference of display with the  $\uparrow$  or  $\downarrow$  direction key and press the  $\text{ENTER}$  key.

Example:  
Set “TYPE Galaxy” to “Always OFF”

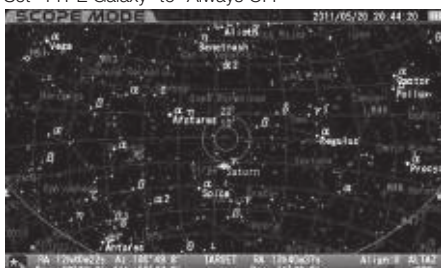

Example:  
Set “TYPE Galaxy” to “Brighter than Mag. 8”

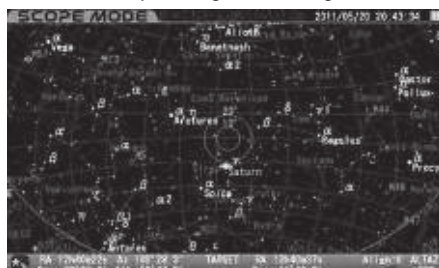

Example:  
Set “TYPE Galaxy” to “Brighter than Mag. 12”





## Chapter 5 APPLICATION

### Mount Setting

This menu allows various settings on your SXD2 mount to suit your preference. Press the **MENU** key to call up System Menu dialog box.

1 In System Menu, choose "Mount Setting" with the **▲** or **▼** direction key and press the **ENTER** key (or the **▶** key) to call up the "Mount Setting" dialog box.

2 The "Mount Setting" dialog box appears.

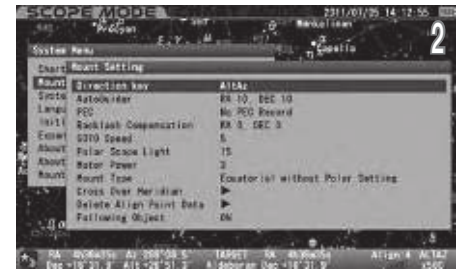

### Direction Key

This allows setting directions of movement when the direction keys **▲** **▼** **▶** **◀** are pressed.

#### The setting is defaulted to „AltAz“

1 In "Mount Setting", choose "Direction Key" with the **▲** or **▼** direction key and press the **ENTER** key (or the **▶** key) to call up the dialog box.

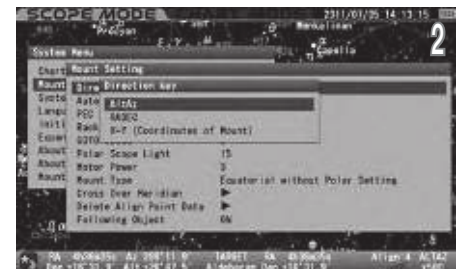
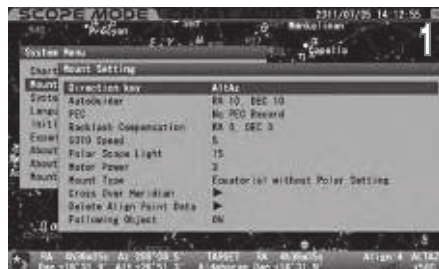

2 In the "Direction Key" dialog box, choose your desired option with the **▲** or **▼** direction key and press the **ENTER** key.

### AltAz

Choose this option when you want to move the SXD2 mount in the altitude and azimuth direction (horizon coordinates) in the celestial sphere. Make sure that the direction keys display on the lower right of the screen are as follows.



- ▲** : Altitude (+) (Highest +90 °)
- ▼** : Altitude (-) (Lowest -90 °)
- ▶** : Azimuth (+) North→East→South→West→...
- ◀** : Azimuth (-) North→West→South→East→...

### RADEC

Choose this option when you want to move the SXD2 mount in the directions of right ascension and declination (celestial coordinates) in the celestial sphere. Make sure that the direction keys display at the lower right of the screen is as follows.



- ▲** : DEC (+) (Maximum +90 °)
- ▼** : DEC (-) (Minimum -90 °)
- ▶** : R.A (+)
- ◀** : R.A (-)

**Note:** As long as the polar alignment is completed, the motion of the mount corresponds to the directions of right ascension and declination regardless of the orientation of the mount to the polar axis.

### X-Y

Choose this option when you want to move the SXD2 mount in the directions of right ascension and declination with the mechanical motion of the mount. Make sure that the direction keys display at the lower right of the screen is as follows.

- ▲** : DEC (+) (Y-axis :Maximum +90°)
- ▼** : DEC (-) (Y-axis :Minimum -90 °)
- ▶** : R.A (+) (X-axis)
- ◀** : R.A (-) (X-axis)



**Note:** Choose this option when you use an autoguider.

# Chapter 5 APPLICATION

## Auto Guide

The STAR BOOK TEN can be used for auto guiding in conjunction with a CCD video camera installed on a guide scope and a built-in autoguider (sold separately) as an expansion unit for the STAR BOOK TEN. An external autoguider which is compatible with the ST series autoguiders from SBIG is available also. You can set up rates for compensation to guide the telescope accurately.

**The setting is defaulted to „RA: 10“ and „DEC: 10“.**

For an operation of the autoguider unit, please refer to instruction manuals provided by the autoguider manufacturer.

### What is Auto guiding?

Auto guiding allows you to guide a telescope on an equatorial mount automatically by means of an autoguider, which compensates signals from a CCD video camera attached on a guide scope to achieve uniform and precise tracking speed of the equatorial mount. The advantages of the autoguider are most apparent during long-exposure astrophotography.

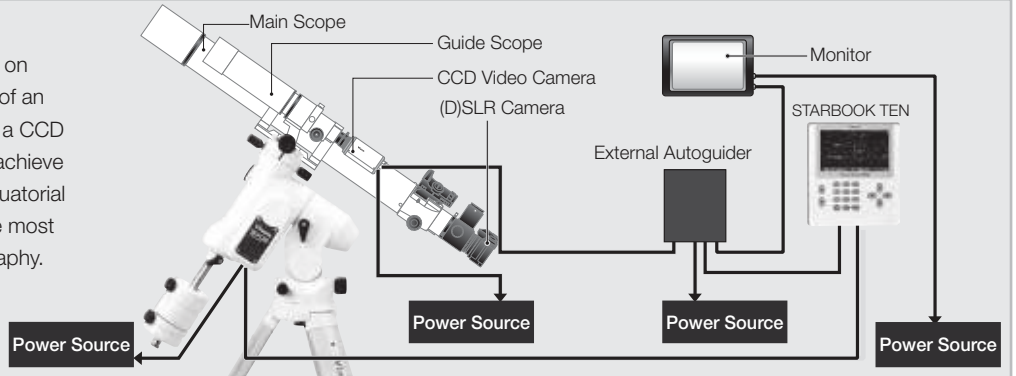

### Using the AutoGuider

1 In "Mount Setting" menu, choose "AutoGuider" with the  $\uparrow$  or  $\downarrow$  direction key and press the  $\text{ENTER}$  key (or the  $\rightarrow$  key) to call up the dialog box.

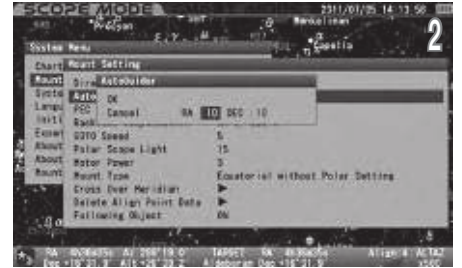
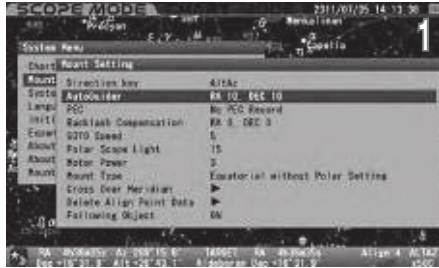

2 Move the cursor to available entry spaces and enter values for compensation with the  $\uparrow$  or  $\downarrow$  directionkey. Using the  $\uparrow$  or  $\downarrow$  zoom key will increase or decrease the number 10 each within the range.

### Setting Rates for Compensation

The value of the compensation can be set between 0 and 99 in one increment both in RA and DEC(0.1x of sidereal rate)

Enter a smaller value if you move the mount slower to make small compensation, or enter a larger value if you move the mount faster to make a larger compensation.

The optimum value for the compensation may vary according to equipment used. Choose the most effective rate to make your auto guiding smoothest.

- 0 : Keep sidereal rate (No compensation is made.)
- 1 :  $\pm 0.1x$  of sidereal rate
- 2 :  $\pm 0.2x$  of sidereal rate
- 3 :  $\pm 0.3x$  of sidereal rate
- :
- :
- 99 :  $\pm 9.9x$  of sidereal rate

3 Then, press the  $\text{ENTER}$  key twice (or press the  $\rightarrow$  key twice alternatively) to save and leave the dialog box.



If autoguiding signals are detected by the STAR BOOK TEN through its autoguider port for corrections, the direction key corresponding to the input signal will light to indicate the status of the operation visually.



The illustration above shows the autoguider compensates signals in the R.A- (descending) direction.

### Tips for Better Autoguiding

When you use the Advance Unit or an external autoguider, it is recommended to refrain from using the following functions.

- Atmospheric Refraction
- P-PEC
- Backlash Compensation

In addition, the following options are recommendable.

Direction Key: X-Y

Mount Type: Equatorial with Polar Setting

## Chapter 5 APPLICATION

### PEC (Periodic Error Correction)

Equatorial mounts with drive motors are designed to precisely track the motion of celestial objects. With the use of a telescope mounted on the equatorial mount, you may notice that stars in the field of view of the telescope at high magnification are drifting back and forth very slowly over a period of time (e.g. 384 seconds with SXD2 mount) in the direction of R.A. This is caused by the motion of the tracking gear wheels and it is part of the design of equatorial mounts. The PEC (periodic error correction) rectifies this phenomenon on the equatorial mount and records the correction electronically.

The tracking accuracy varies in irregular motion and must be corrected as precisely as possible.

**Note:** The SXD2 mount does not detect a start point of the PEC recording until the R.A and Declination axes are rotated electrically at an angle of one degree and more. Pay attention to it if you start the PEC recording immediately after you turn on the mount.

#### Starting the PEC Recording

- 1 Choose "Equatorial with Polar Setting" in the Mount Type described on page 82. Accurately polar align the mount.
- 2 Prepare an eyepiece with crosshairs such as a Vixen OR-12.5mm with illuminated reticle. Put a guide star on the center of the crosshairs in the eyepiece. Go to high magnification with an eyepiece as high as 200x and more.
- 3 In the "Mount Setting" menu, choose "PEC" with the  $\uparrow$  or  $\downarrow$  direction key and press the  $\text{ENTER}$  key to call up the dialog box.
- 4 In the "PEC" dialog box, choose "Rec Start" with the  $\uparrow$  or  $\downarrow$  direction key and press the  $\text{ENTER}$  key (or the  $\rightarrow$  key).
- 5 The PEC recording starts with chimes after counting down 3 seconds. Tracking the guide star very carefully as your corrections during manual operation are recorded.

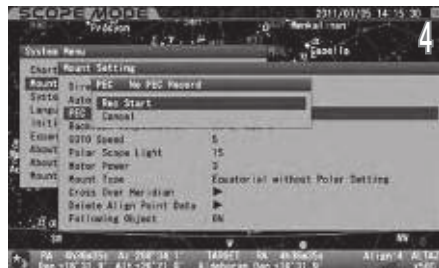
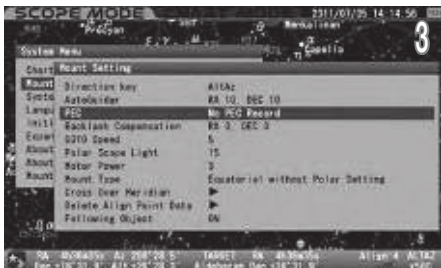
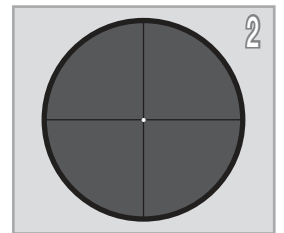

The period of time for the PEC recording is 8 minutes (480 seconds).

- 6 On starting the PEC recording, the speed of correction is fixed at 0.5 times of sidereal rate regardless of an enlargement or reduction of the star chart. The  $\uparrow$   $\downarrow$  zoom keys allow enlarging or reducing the star chart on the screen during the PEC recording.

During the PEC recording the count number is displayed in red at the left corner of the information bar on the bottom of the screen. The counter starts from 479 and counts down every second to 0 and repeat.



Tracking ON



PEC on recording (red)

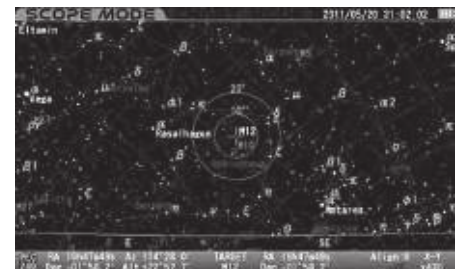
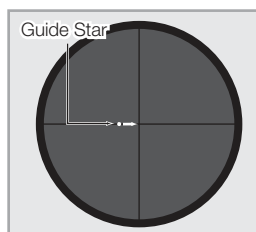

- 7 A cycle of the PEC recording ends with another chime as soon as the 480 seconds has elapsed, but the duration of the recording continues until you stop it. The PEC recording is renewed in each cycle.

**Note:** You can complete the PEC recording per cycle and it must be started from a defined starting point. If you can't start the PEC recording right after turning on the power of the SXD2 mount, rotate the mount electrically more than one degree in both R.A and DEC to detect the starting point.

## Chapter 5 APPLICATION

### Stopping the PEC Recording

1 Pressing any of the keys on the STAR BOOK TEN except the zoom and direction keys will stop the PEC recording.

At the same time, the dialog box appears on the screen. Choose OK with the  $\uparrow$  or  $\downarrow$  direction key and press the  $\text{ENTER}$  key.

2 If the PEC recording is stopped, only the ongoing record of the current cycle is cleared.

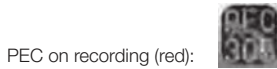

If more than one cycle is recorded before you stop the PEC recording, the count number is high lighted in green and playback of the PEC recording starts. If less than one cycle is recorded before you stop, the recording is not saved and the counter does not turn to the playback.

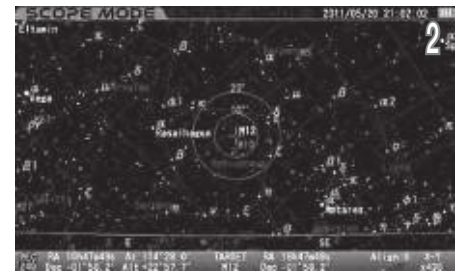
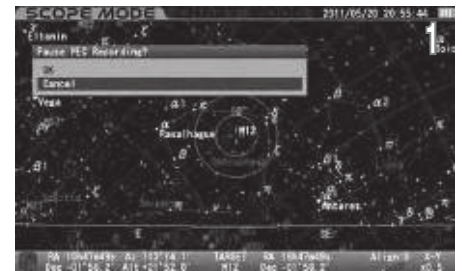

### Resuming the PEC Recording

If you continue the PEC recording more than one cycle, corrections of the first recording will be reproduced at the second recording, and thus improved by the PEC recording

1 In the "Mount Setting" menu, choose "PEC" with the  $\uparrow$  or  $\downarrow$  direction key and press the  $\text{ENTER}$  key to call up the dialog box.

2 In the "PEC" dialog box, choose "Rec Start" with the  $\uparrow$  or  $\downarrow$  direction key and press the  $\text{ENTER}$  key (or the  $\leftarrow$  key).

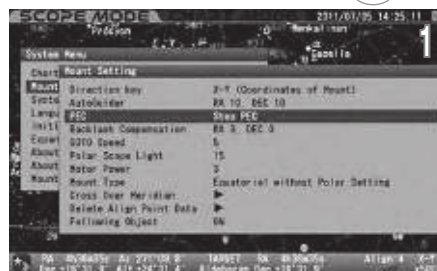

### Starting Playback of the PEC

1 In the "Mount Setting" menu, choose "PEC" with with the  $\uparrow$  or  $\downarrow$  direction key and press the  $\text{ENTER}$  key to call up the dialog box.

2 In the "PEC" dialog box, choose "Play Start" with the  $\uparrow$  or  $\downarrow$  direction key and press the  $\text{ENTER}$  key (or the  $\leftarrow$  key).

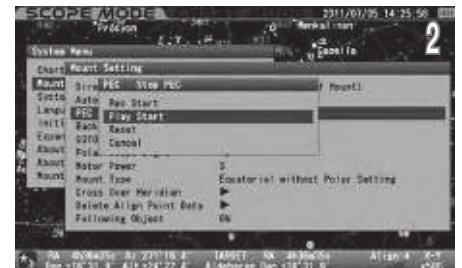
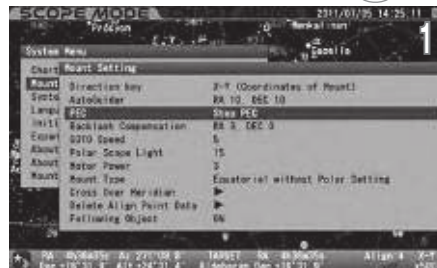

In the playback of the PEC, the count number is displayed in green and counted down every 480 seconds per cycle.



Playback of the PEC is in progress

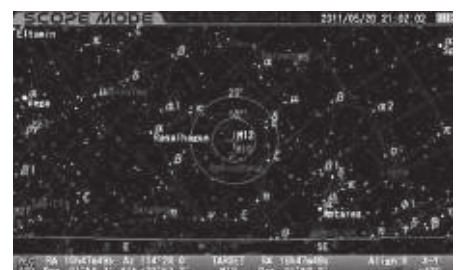

## Chapter 5 APPLICATION

### Stopping Playback of the PEC

1 In the “Mount Setting” menu, choose “PEC” with the  $\uparrow$  or  $\downarrow$  direction key and press the  $\text{ENTER}$  key to call up the dialog box.

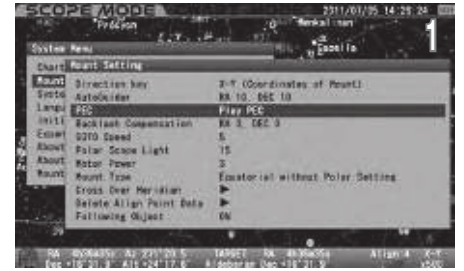

2 In the “PEC” dialog box, choose “Play Stop” with the  $\uparrow$  or  $\downarrow$  direction key and press the  $\text{ENTER}$  key (or the  $\leftarrow$  key).

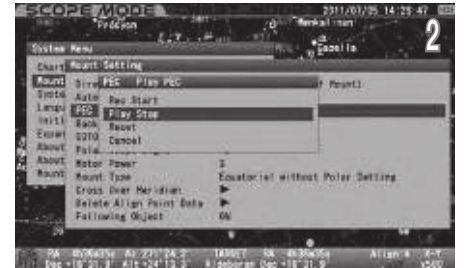

### Resetting the PEC

The PEC recording is held until you turn off the power, but you can reset the recorded PEC at your option during operation. ※

1 In the “Mount Setting” menu, choose “PEC” with the  $\uparrow$  or  $\downarrow$  direction key and press the  $\text{ENTER}$  key to call up the dialog box.

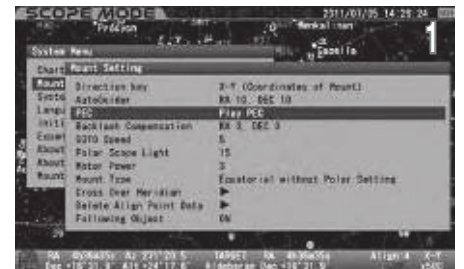

2 Choose “Reset” with the  $\uparrow$  or  $\downarrow$  direction key and press the  $\text{ENTER}$  key (or the  $\leftarrow$  key).

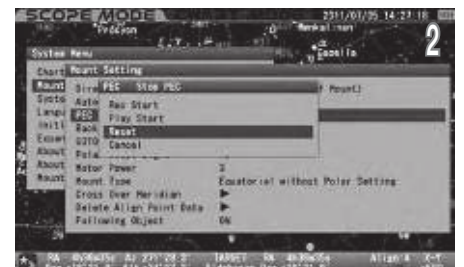

※ All the recorded PEC are erased.

## Chapter 5 APPLICATION

### Backlash Compensation

Backlash is a momentary stoppage of the tracking motion of the mount that occurs when the motor gears reverse their rotation. Backlash does not occur while the mount moves at a constant speed as the gears keep contact with each other. Backlash may occur when the telescope is moved with the direction keys manually.

The backlash compensation provides a reduced time lag at the point of reversed motion where the gears lose the contact. It gives smoother rotation of the gears on the mount.

### CAUTION

Backlash compensation is not compatible with an autoguider in most cases. Cancel using this option when you use an autoguider.

**The setting is defaulted to „RA: 0“ and „DEC: 0“.**

#### Checking the Backlash

It is convenient to use a bright 1st-magnitude star in order to check a backlash amount for compensation.

1 Precisely polar align the mount.

2 In SCOPE MODE, choose the motor speed to be set approximately between 1.2x and 4.0x with the  $\uparrow$  or  $\downarrow$  zoom key with looking at the right corner of the information bar on the bottom of the screen.



3 Confirm the amount of backlash in the direction of R.A as follows. Center the 1st-magnitude star in the field of view of your eyepiece and watch how the star moves while pressing the  $\leftarrow$  direction key. Press the direction key until the star begins to move.

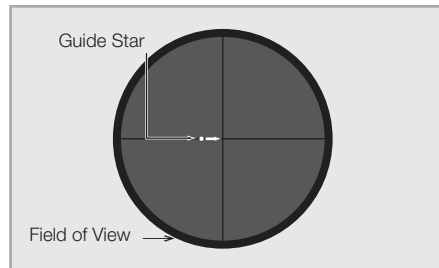

4 Press the  $\rightarrow$  direction key to watch how the star moves in the field of view.

If there is a time lag and the star does not begin to move instantly toward the direction you press, a value for the backlash compensation is set too small (weak) or set to "0".

On the contrary, if the star begins to move quickly and becomes larger at the same time you press, a value for the backlash compensation is set too large (strong).

5 Confirm the amount of backlash in the direction of DEC in the same way with the  $\uparrow$   $\bullet$   $\downarrow$  direction keys.

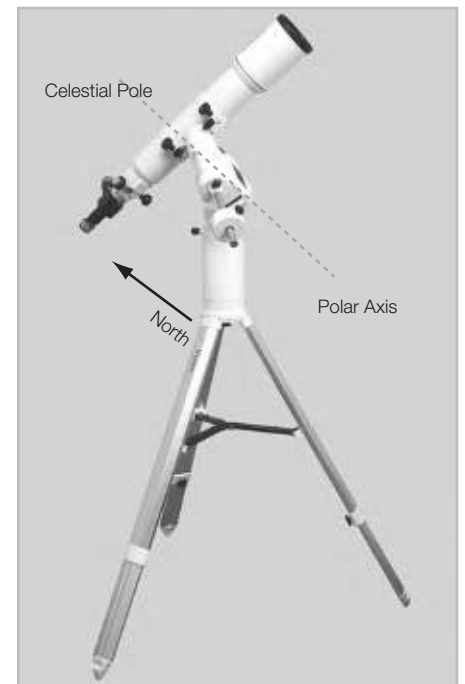

## Chapter 5 APPLICATION

### Setting the Backlash

The values for the backlash compensation are available between “0” and “99” both in R.A and DEC

1 In the “Mount Setting” menu, choose “Backlash Compensation” with the  $\uparrow$  or  $\downarrow$  direction key and press the  $\text{ENTER}$  key to call up the dialog box.

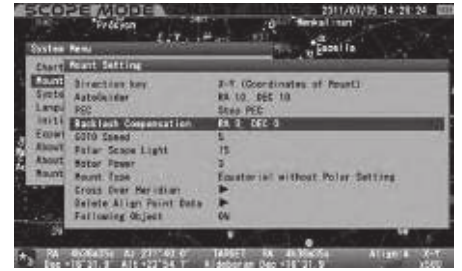

2 In the “Backlash Compensation” dialog box, move the cursor to entry spaces with the  $\uparrow$  or  $\downarrow$  direction key and enter your desired values with the  $\uparrow$  or  $\downarrow$  direction key. Pressing the  $\text{ENTER}$  key will shift the cursor to OK. Then press the  $\text{ENTER}$  again to save and leave the dialog box.

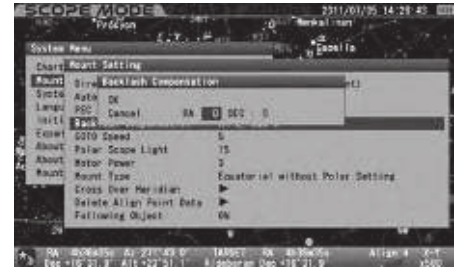

**Note:** Using the  $\uparrow$  or  $\downarrow$  zoom key will increase or decrease by 10 within the range.

### Tips on Setting of Backlash Compensation

Watch how the telescope moves when you increase the value. Start with setting an initial reference value (10 for example), and double this value after checking the telescope movement with the initial value.

If the second value (=20) is too small to compensate for the backlash, enter the number doubled (=40) as the second value. Likewise, increase the number by doubling the value if necessary.

Example: Enter 20 for setting the backlash compensation.

If this value is too weak for the compensation, increase the value to 40. If it generates too much compensation as a result, decrease to the value halfway between 20 and 40. If the value of 30 is still somewhat larger for the compensation, decrease to 25. On the contrary, if 30 is somewhat small, increase to 35. In this way you can adjust the mount for the most effective backlash compensation.

Example: R.A = 10, DEC = 25



**Note:** The “Backlash Compensation” has to be null if you use an autoguider.  
R.A = 0, DEC = 0

## Chapter 5 APPLICATION

### GOTO Speed

The maximum speed of automatic Go-To slewing can be chosen from the following 5 levels.

- 5 High : 800x (about 800 times of sidereal rate)
- 4 : 600x (about 600 times of sidereal rate)
- 3 : 400x (about 400 times of sidereal rate)
- 2 : 200x (about 200 times of sidereal rate)
- 1 Low : 100x (about 100 times of sidereal rate)

**Note:** The speed is an approximation and it depends on loaded weight and condition of power source.

#### The setting is defaulted to „5“.

1 In the “Mount Setting” menu, choose “GOTO Speed” with the  $\uparrow$  or  $\downarrow$  direction key and press the  $\text{ENTER}$  key (or the  $\rightarrow$  key) to call up the dialog box.

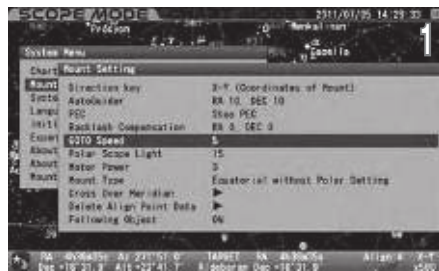

2 In the “GOTO Speed” dialog box, choose your desired value with the  $\uparrow$  or  $\downarrow$  direction key. Press the ENTER key to save and leave the dialog box.

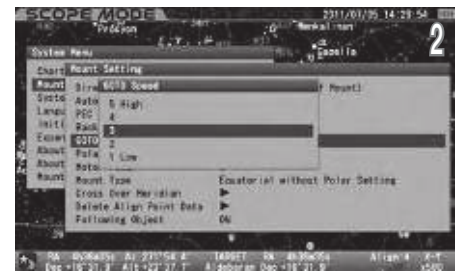

### Polar Scope Light

This allows adjustment of the brightness of the illuminator for the polar axis scope. While looking through the polar axis scope, adjust the brightness by number with the  $\uparrow$  or  $\downarrow$  direction key so that the reticle of the polar axis scope and Polaris (or 4 reference stars of Octans in the southern hemisphere) are visible at the same time in the field of view.

- 20 : The brightest
- :
- 0 : OFF the light

#### The setting is defaulted to „15“.

1 In the “Mount Setting” menu, choose “Polar Scope Light” with the  $\uparrow$  or  $\downarrow$  direction key and press the  $\text{ENTER}$  key (or the  $\rightarrow$  key) to call up the dialog box.

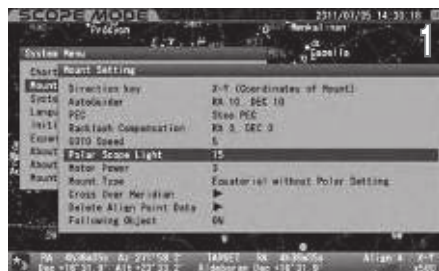

2 In the “Polar Scope Light Brightness” dialog box, choose your desired option with the  $\uparrow$  or  $\downarrow$  direction key and press the  $\text{ENTER}$  key.

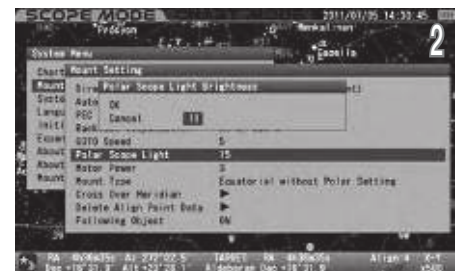

**Note:** Using the  $\uparrow$  or  $\downarrow$  zoom key will increase or decrease by 10 within the range.





## Chapter 5 APPLICATION

### Motor Power

This allows for the changing electricity consumption of the mount as the need arises. When electricity consumption is set to “3”, the mount will easily accomplish tracking and Go-To slewing of your telescope and equipment up to 10 kgs (22 lbs). The smaller the value is set, the lower the electricity consumption is used, but it may cause a failure in tracking or Go-To slewing due to a drop of the motor torques.

#### Approximate values

- 4 High** : 12V, 0.6A to 2.2A (7.2 watts to 26 watts)
- 3** : 12V, 0.55A to 2.0A (6.6 watts to 24 watts)
- 2** : 12V, 0.5A to 1.8A (6.0 watts to 22 watts)
- 1 Low** : 12V, 0.45A to 1.7A (5.4 watts to 20 watts)

### The setting is defaulted to „3“

#### Note

\*The wattages are based on the loading weight of 10 kgs (22 lbs) approximately. The electricity consumption is affected by the size of equipment mounted and the temperature.

\*Electricity consumption at the maximum loading weight of 15 kgs (33 lbs) would be about 0.6A to 2.5A (7.5 watts to 30 watts) at 12V.

**1** In the “Mount Setting” menu, choose “Motor Power” with the  $\uparrow$  or  $\downarrow$  direction key and press the  $\text{ENTER}$  key (or the  $\rightarrow$  key) to call up the dialog box.

**2** Choose your desired value by number with the  $\uparrow$  or  $\downarrow$  direction key. Press the  $\text{ENTER}$  key to enter and leave the dialog box.

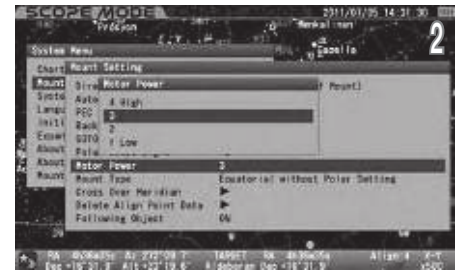
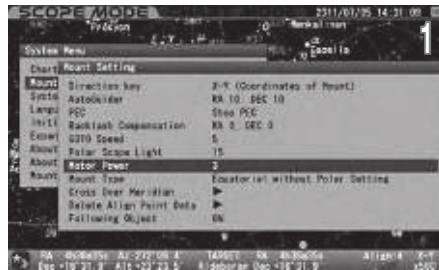

#### About Failure of Tracking or Go-To Slewing

If your telescope is not well-balanced or “Motor Power” is not set properly, the mount may not have torque enough to track or slew the telescope. If this happens, the STAR BOOK TEN will sound the alarm and the motors will stop momentarily. Then, the mount will restart the tracking and Go-To slewing automatically to reach the target.

#### Tips on Using the Motor Power Menu

If a total weight of the equipment installed on the mount is no more than 10 kgs (22 lbs) (excluding counterweights) and well-balanced, the default setting “3” would be sufficient enough to operate the mount stably. Chose the setting “4” if the loading weight exceeds 10 kgs (22 lbs), and choose the setting “2” or “1” if the loading weight is far less than 10 kgs (22 lbs) and you want to keep the electricity consumption as low as possible.

An allowable payload of the mount is limited according to the size of your telescope regardless of its weight. Typically the larger the diameter of the telescope, the smaller the payload the mount accepts.

Do not overly restrain the electricity consumption as it may result in failure of the motor controls

## Chapter 5 APPLICATION

### Mount Type

This allows choosing a mount type either “Equatorial with Polar Setting” or “Equatorial without Polar Setting”.

#### The setting is defaulted to „Equatorial without Polar Setting“

- 1 In the “Mount Setting” menu, choose “Mount Type” with the  $\uparrow$  or  $\downarrow$  direction key and press the  $\text{ENTER}$  key (or the  $\rightarrow$  key) to call up the dialog box.
- 2 Choose your desired option the  $\uparrow$  or  $\downarrow$  direction key. Press the  $\text{ENTER}$  key to enter and leave the

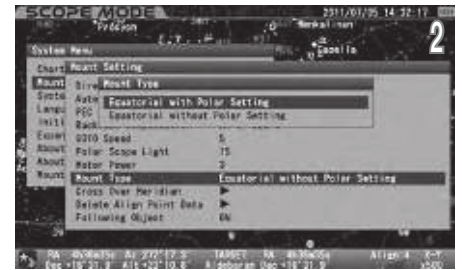
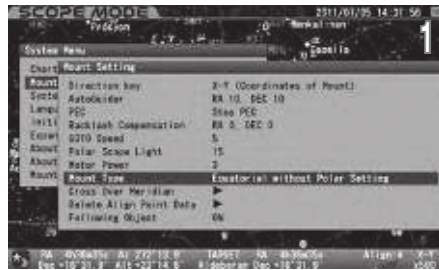

#### Equatorial without Polar Setting

- \* Establishing star alignment in several points spread across the sky will make the GoTo slewing and tracking more accurate.
- \* With the use of this option you can enjoy Go-To slewing easily without performing a polar alignment.
- \* Since the mount is in motion without polar alignment, the tracking is done not only in the direction of R.A but also in the direction of DEC for correction. Choosing this option is not suitable for long exposure astro-photography.

#### Equatorial with Polar Setting

- \* Since the mount is polar aligned, even a few points of star alignment will make the Go-To slewing very accurate. Adding points of the star alignment will make the Go-To slewing perfect.
- \* The tracking at sidereal rate is made only in the direction of R.A and the motion in the direction of DEC is cut out. Because of this, the accuracy of the tracking depends on how the mount has been aligned to the north (or south) celestial pole correctly. If the polar alignment is inaccurate, your telescope will shift in the direction of DEC during the tracking.

**Note:** If the atmospheric reflection correction is in operation, it may affect the motion of R.A and DEC

## Chapter 5 APPLICATION

### Cross Over Meridian

If your object of observation with the SXD2 mount is located on the east side of the meridian, the gravity of center of your telescope would be on the west side of the R.A axis of the mount. As the mount turns at sidereal rate tracking the object which moves toward the culmination, the optical tube approaches a place lower than the R.A axis of the mount. As a result, the optical tube may hit a leg of the tripod or the leg may interfere with instruments installed on the optical tube. To avoid this, the SXD2 mount has a safety function which makes the optical tube turn to the opposite position when the observing object comes to its culmination.

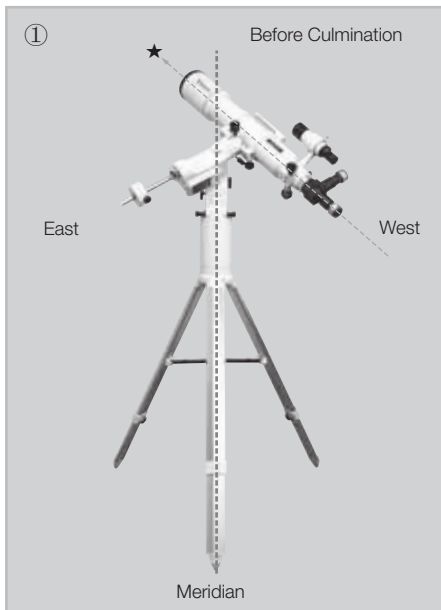

However, this may be troublesome if you intend to do astro-imaging of celestial objects in the south side of the sky or photographing an object that is almost approaching to the culmination during the exposure. The function of "Cross Over Meridian" allows you to change a timing of the reverse motion of the optical tube. It is not possible to cancel the revised motion itself.



### CAUTION

The function of "Cross over Meridian" is a safety precaution to prevent the optical tube and equipped instruments from hitting the leg of the tripod. Wrong settings could cause scratches or damage to the optical tube and instruments, and could result in injuries. When using this function, be sure to check the configuration of each instrument installed.

### The settings are defaulted to the following

- Warning for Telescope Reverse** : Over 0 degrees Step 2 degrees
- Override Meridian Stop Point** : Over 3 degrees
- GoTo (East Side)** : Over 0 degrees

1 In the "Mount Setting" menu, choose "Cross Over Meridian" with the  $\uparrow$  or  $\downarrow$  direction key and press the  $\text{ENTER}$  key (or the  $\text{RIGHT}$  key) to call up the dialog box.

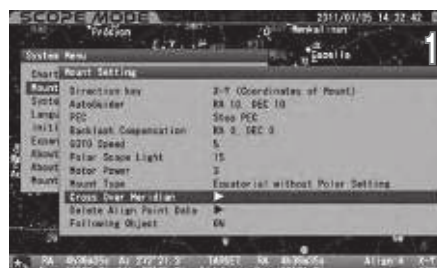

2 In the "Cross Over Meridian" dialog box, choose your desired option the  $\uparrow$  or  $\downarrow$  direction key.

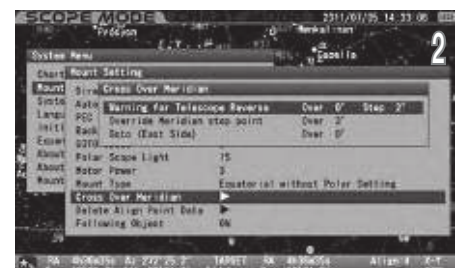

## Chapter 5 APPLICATION

### Warning for Telescope Reverse

This allows setting a point of the warning message to warn you against turning of the optical tube to the opposite position. The alarm sounds at the same time the warning message is indicated. The timing of the warning message can be designated by angle and it can be set to recall repeatedly with an interval of every one degree and more until the mount stops.

#### Warning for Telescope Reverse

**Over** : An angle to the west from the meridian as a point of warning for the telescope reverse. The setting value cannot exceed the angle to stop the mount forcibly.

**Step** : An Interval to recall the warning message. The setting is available from 1 degree to 90 degrees.

The „Cross Over Meridian“ setting screen



Example of warning for Telescope Reverse 5 degrees Step 2 degrees

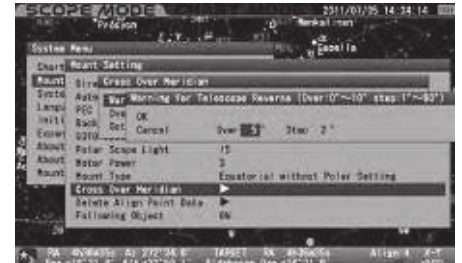

In the “Cross Over Meridian” dialog box, choose “Warning for Telescope Reverse” and press the **ENTER** key (or the **▶** key) to call up the dialog box. Move the cursor to an available entry space with the **▶** or **◀** direction key and enter your desired value with the **▲** or **▼** direction key. Then, press the **ENTER** key twice to enter and leave the dialog box.

### Override Meridian Stop Point

This allows setting a point to make the optical tube turn to the opposite position manually when it goes over the meridian.

#### Override Meridian Stop Point

**Over** : An angle to the west from the meridian as a point of turning the optical tube to the opposite position. The setting range is restricted by either the value of “warning for the telescope reverse” or the value of “Goto (East Side)”; it is determined by the larger one and available up to 90 degrees west of the meridian.

The „Cross Over Meridian“ setting screen

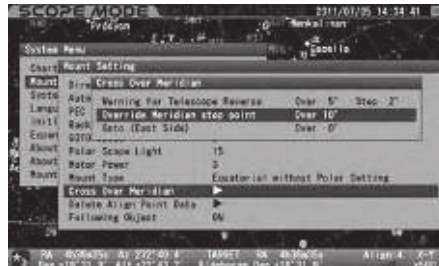

Example of stop at 20 degrees west of the meridian

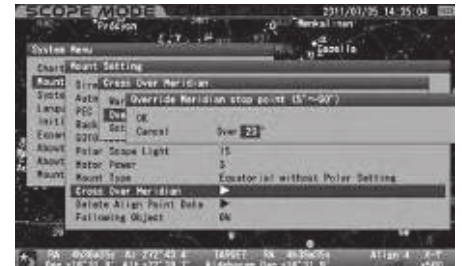

In the “Cross Over Meridian” dialog box, choose the “Override Meridian Stop Point” dialog box and press the **ENTER** key (or the **▶** key) to call up the dialog box. Enter your desired value with the **▲** or **▼** direction key. Then, press the **ENTER** key twice to enter and leave the dialog box.

### GoTo (East Side)

This allows shifting a point of the telescope reverse to the east side of the meridian. You can slew the telescope to your object located adjacent to the culmination so that the optical tube keeps the position just after the telescope reverse finishes. It is a convenient feature as you can start long-exposure astrophotography on the south side of the sky without interrupting the tracking

**Over** : An angle to the east from the meridian as a point of turning the optical tube on the east side of the meridian to the opposite position. The setting range is restricted by the value of “override meridian stop point”

The „Cross Over Meridian“ setting screen

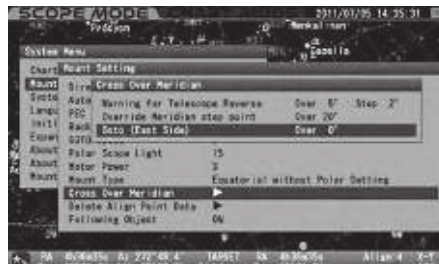

Example of stop at 10 degrees east of the meridian

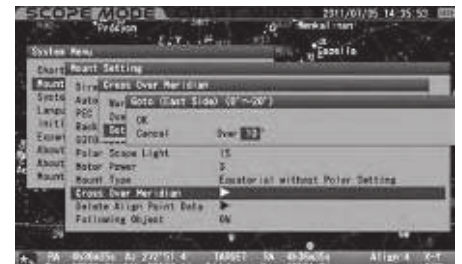











In the “Cross Over Meridian” dialog box, choose the “GoTo (East Side)” dialog box and press the **ENTER** key (or the **▶** key) to call up the dialog box. Enter your desired value with the **▲** or **▼** direction key. Then, press the **ENTER** key twice to enter and leave the dialog box.



## Chapter 5 APPLICATION

### Delete Align Point Data

This allows calling up and deleting your alignment points from a list in the database. You cannot retrieve the deleted alignment point. This will not function if there is no alignment point.

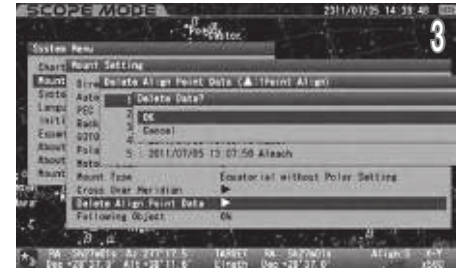
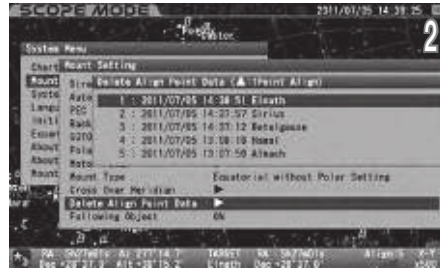
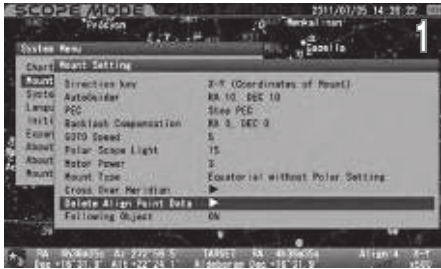
- 1 Keep pressing the  key until the dialog box appears (or press the  key to access Mount Setting). In “Mount Setting”, choose “Delete Align Point Data” with the  or  direction key and press the  key (or the  key) to call up the dialog box.
- 2 Move the cursor with the  or  direction key to the data you want to delete.
- 3 Press the  key to call up the dialog box and press the  key to delete.





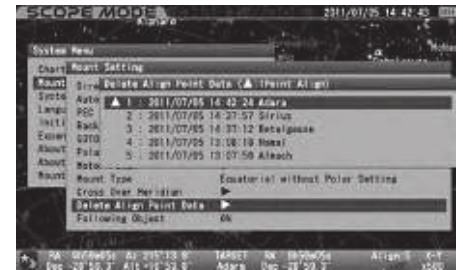



If you find an alignment star marked  in the list, it indicates that no linkage has been made between the alignment point with mark and the other established alignment points. Delete any alignment point marked  accordingly.



### Following Object

This allows switching OFF or ON the tracking motion of the mount. It is convenient to align the finder scope in the daytime and use for terrestrial observation.

The setting is defaulted to „ON“.

- 1 In the “Mount Setting” menu, choose “FollowingObject” with the  or  direction key and press the  key (or the  key) to call up the dialog box.
- 2 Choose your desired option the  or  direction key. Press the  key to enter and leave the dialog box.

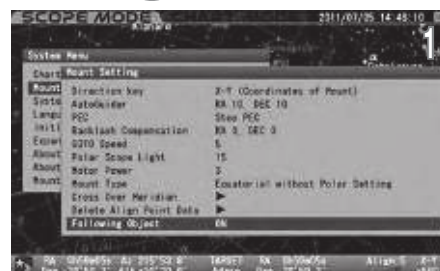

- 3 Confirm that the icon at the lower left of the information bar on the bottom of the screen is switched as follows:

Following Object : Tracking ON



Tracking OFF



The setting is switched to OFF automatically if the mount is stopped forcedly during the GoTo slewing or the telescope is slewed to the terrestrial objects registered in the database or the target object sets below the horizon. Switch the “Following Object” to ON or slew to a new celestial target above the horizon.

## Chapter 5 APPLICATION

### System Setting

You can choose the settings for various functions to suite your preference. Press the **MENU** key to call up “System Menu”.

In “System Menu”, choose “System Setting” with the **▲** or **▼** direction key and press the **ENTER** key (or the **▶** key) to call up the dialog box.

**Note:** Most of menus in “System Setting” are accessible at “Initial Configuration” which is displayed each time immediately after you turn on the power switch of the SXD2 mount.

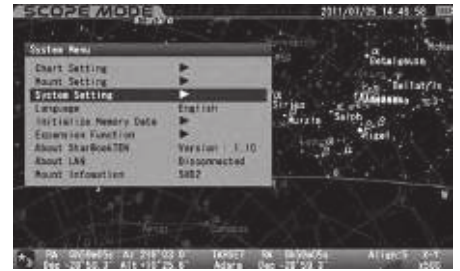

### Local Time Setting

In the “System Setting” menu, choose “Local Time Setting” with the **▲** or **▼** direction key and press the **ENTER** key (or the **▶** key) to call up the dialog box. Refer to the Chapter 2 “Initial Setting”.

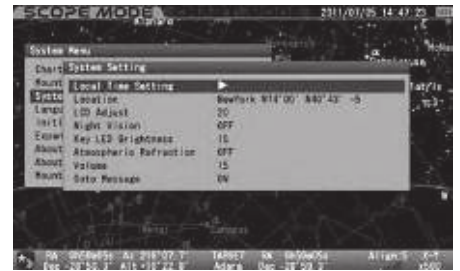

### Location

In the “System Setting” menu, choose “Location” with the **▲** or **▼** direction key and press the **ENTER** key (or the **▶** key) to call up the dialog box. Refer to the Chapter 2 “Initial Setting”.

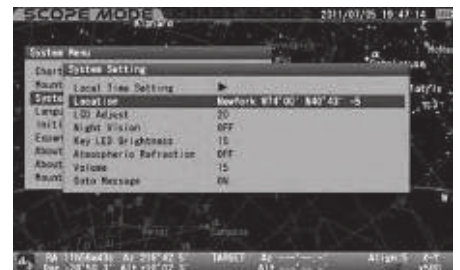

### LCD Adjust

In the “System Setting” menu, choose “LCD Adjust” with the **▲** or **▼** direction key and press the **ENTER** key (or the **▶** key) to call up the dialog box. Refer to page 59.

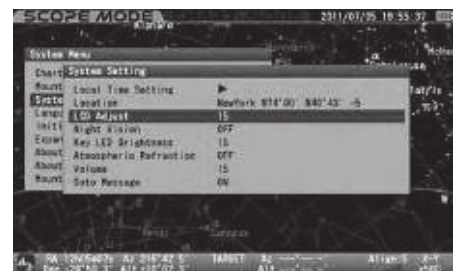

### Night Vision

In the “System Setting” menu, choose “Night Vision” with the **▲** or **▼** direction key and press the **ENTER** key (or the **▶** key) to call up the dialog box. Refer to page 60”.

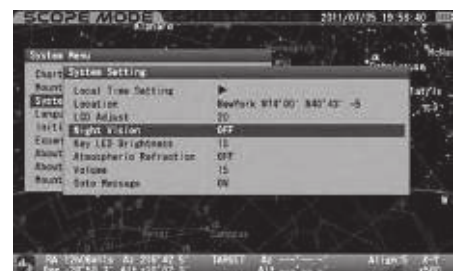

## Chapter 5 APPLICATION

### Key LED Brightness

In the “System Setting” menu, choose “Key LED Brightness” with the  $\uparrow$  or  $\downarrow$  direction key and press the  $\text{ENTER}$  key (or the  $\rightarrow$  key) to call up the dialog box. Refer to page 60.

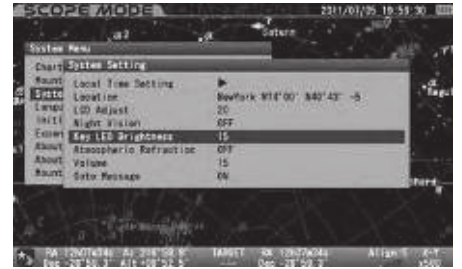

### Atmospheric Refraction

In the “System Setting” menu, choose “Atmospheric Refraction” with the  $\uparrow$  or  $\downarrow$  direction key and press the  $\text{ENTER}$  key (or the  $\rightarrow$  key) to call up the dialog box. Refer to page 61.

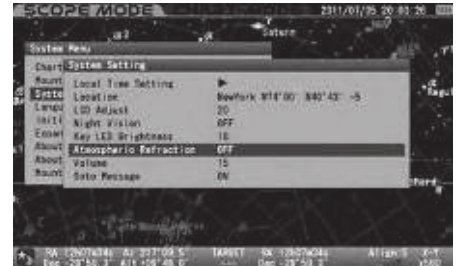

### Volume

In the “System Setting” menu, choose “Volume” with the  $\uparrow$  or  $\downarrow$  direction key and press the  $\text{ENTER}$  key (or the  $\rightarrow$  key) to call up the dialog box. Refer to page 61.

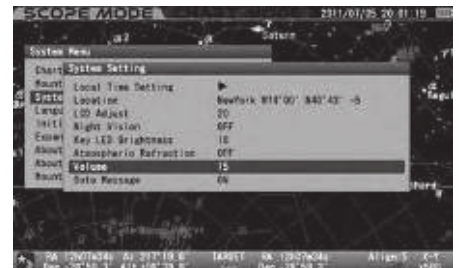

### GoTo Message

This allows you to switch OFF or ON the dialog box that confirms Go-To slewing. If the setting is OFF, the telescope will start the Go-To slewing to your target object as soon as you enter the command. The mount will carry out the Go-To slewing at the same time you call up and enter the object by the command key in the Chart Mode.

#### The setting is defaulted to „ON“.

1 In the “System Setting” menu, choose “GoTo Message” with the  $\uparrow$  or  $\downarrow$  direction key and press the  $\text{ENTER}$  key (or the  $\rightarrow$  key) to call up the dialog box.

2 In the “GoTo Message” dialog box, choose your desired option the  $\uparrow$  or  $\downarrow$  direction key and press the  $\text{ENTER}$  key (or the  $\rightarrow$  key). Press the  $\text{ENTER}$  key (or the  $\rightarrow$  key) to save and leave the dialog box.



## Chapter 5 APPLICATION

### Language

In the “System Setting” menu, choose “Language” with the  $\uparrow$  or  $\downarrow$  direction key and press the  $\text{ENTER}$  key (or the  $\rightarrow$  key) to call up the dialog box. Refer to the Chapter 2 “Initial Setting”.



### Initialize Memory Data

In the “System Setting” menu, choose “Initialize Memory Data” with the  $\uparrow$  or  $\downarrow$  direction key and press the  $\text{ENTER}$  key (or the  $\rightarrow$  key) to call up the dialog box. Refer to page 62”.



### Expansion Function

This function becomes available when an expansion module is installed. The Advance Unit is an expansion module available for the STAR BOOK TEN as of November 2012. For details, read the instruction manuals for the Advance unit.

### About StarBook TEN

This allows you to access the program version, IP address and MAC address of your STAR BOOK TEN controller. This information is required for program updates and downloads from a PC through a local area network.

In the “System Menu” , choose “About StarBook TEN” with the  $\uparrow$  or  $\downarrow$  direction key and press the  $\text{ENTER}$  key (or the  $\rightarrow$  key) to display firmware version, IP address and MAC address of your STAR BOOK TEN. Refer to page 63”.



### About LAN

You can confirm “IP address” and “MAC address” on the “Initial Configuration” screen and “System Menu”.

### Access from the „Initial Configuration“ menu

In the “Initial Configuration” menu, choose “About LAN” with the  $\uparrow$  or  $\downarrow$  direction key and press the  $\text{ENTER}$  key (or the  $\rightarrow$  key) to display the information screen of “About LAN”. Refer to page 63”.

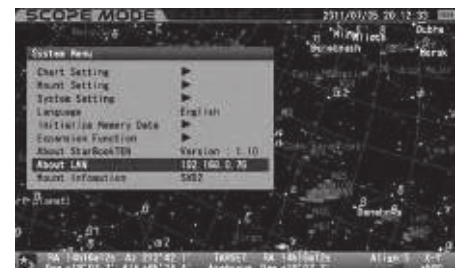



## Chapter 5 APPLICATION

### Mount Information

This displays information on the number of the teeth on the wheel gear, gear reduction ratio.

Mount Type: SXD2

$X = -180 \times 4$  (Number of the RA wheel gear teeth x Reduction ratio)

$Y = 180 \times 4$  (Number of the Declination wheel gear teeth x Reduction ratio)

1 In "System Menu", choose "Mount Information" with the  $\uparrow$  or  $\downarrow$  direction key and press the  $\text{ENTER}$  key (or the  $\text{PAGE}$  key).

2 The "Mount Information" screen appears.



The following are indicated at "Mount Information" if the STAR BOOK TEN is not connected to the mount and used independently.

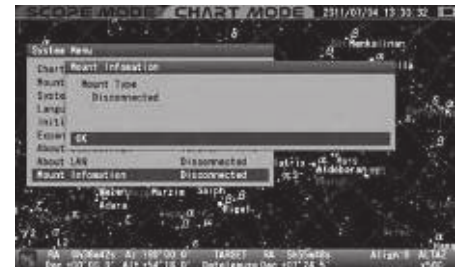
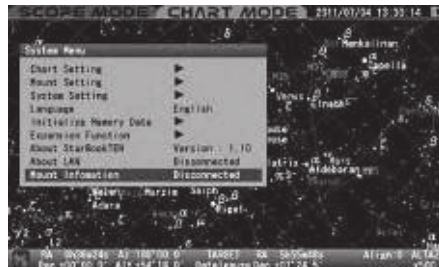

## Chapter 5 APPLICATION

### IV. Using as a Stand-alone Unit

The STAR BOOK TEN has a power connection port of DC 12V input which allows you to use the STAR BOOK TEN as a stand-alone unit. This is convenient for setting location, updating firmware, entering orbital elements of comet from a PC and as a star map.

There is no power switch on the STAR BOOK TEN and it will turn on if you connect a power source. You simply disconnect the power source to turn off the STAR BOOK TEN.

Any functions that are related directly to motion of the SXD2 mount are inoperative and you cannot switch the display to SCOPE MODE.



### Connecting to LAN

The STAR BOOK TEN is designed to connect to a PC with a LAN cable so that the latest firmware or application programs can be downloaded for updates. Use a commercially available LAN cable and connect the STAR BOOK TEN directly to a PC.

### Requirements

- PC which is capable of LAN connection
- LAN cable (LAN crossover cable)
- Power Source (AC Adapter 12V-3A and such)
- Applicable OS environment of the PC (Applicable OS environment of the PC)
  - Microsoft Windows® XP HomeEdition
  - Microsoft Windows® XP Professional
  - Microsoft Windows® Vista HomeBasic
  - Microsoft Windows® Vista HomePremium
  - Microsoft Windows® Vista Business
  - Microsoft Windows® Vista Ultimate
  - Microsoft Windows® 7 HomePremium
  - Microsoft Windows® 7 Professional
  - Microsoft Windows® 7 Ultimate
  - Microsoft Windows® 8
  - Microsoft Windows® 8 Pro

\*Not applicable to MacOS, Linux and Unix.
- Web Browser
  - Internet Explorer version 5.0 or higher
- CPU
  - Pentium II 400MHz or better
- RAM
  - 256MB or better
- LAN
  - 10BASE-T/100BASE-T

### Ferrite Core

Attach the supplied ferrite core to the LAN cable so that it is placed near the connection terminal of the LAN cable which is connected to the STAR BOOK TEN as shown in the figures.

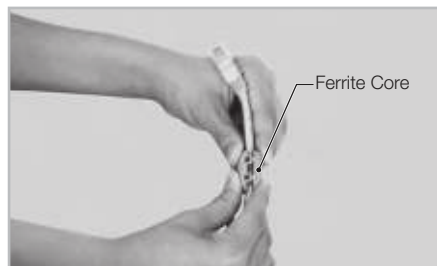

## Chapter 5 APPLICATION

### V . Updating your STAR BOOK TEN

Download the program file of updates from Vixen's website to your PC. Connect the STAR BOOK TEN and the PC directly with the LAN cable.

#### CAUTION

- \* Use the AC adapter 12V 3-A or the same power source you use for the SXD2 mount.
- \* Make sure that the PC is used under a stable power supply for transmission of data.
- \* You may fail to reboot the STAR BOOK TEN if the power supply is cut during updating. If this is the case, ask your local Vixen dealer for repair (chargeable to you).
- \* You may need to alter the network settings in your PC for updating. Be sure write down the original settings before changing them.
- \* All the data stored in the memory may be initialized as a result of updating. Write down the current settings, just in case.

#### Update Procedure

- 1 Download in advance the newest firmware version of the STAR BOOK TEN which is posted on the home page of Vixen's website at <https://www.vixen.co.jp> to a directory on the PC.
- 2 Directly connect the STAR BOOK TEN and the PC with the LAN crossover cable.
- 3 Turn ON the STAR BOOK TEN. Connecting the power supply cord will start up the STAR BOOK TEN.
- 4 Turn ON your PC and set up the OS.
- 5 Wait for a period of one minute as the STAR BOOK TEN and PC will automatically acquire information on networking.
- 6 At the main menu, choose "About LAN" and press **ENTER**.

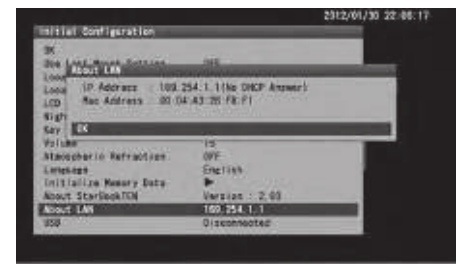

Confirm that IP address is indicated as follows: **IP Address: 169.254.a.b** (a and b are indefinite numbers)

#### CAUTION

- \* Never disconnect the power supply cord for the STAR BOOK TEN and the LAN crossover cable while the STAR BOOK TEN is in communication with the PC. This could result in unrecoverable damage.
- \* The IP address may differ if the STAR BOOK TEN is connected indirectly through a network.
- \* If the connection to the PC does not finish, the message "Waiting..." will be displayed instead of the IP address. Or, if the connection ends in failure, the message "Disconnected" will be displayed. If this is the case, wait a little while or make sure that the LAN crossover cable is connected securely.

- 7 Open Internet Explorer (or your internet browser) and enter the IP address you obtained in the above in the address bar to display an entry page. The following appears on the screen.

#### Example:

If the IP address is 169.254.1.1, put <http://169.254.1.1> on the address bar.

**Note:** Change the setting to have the address bar appear if it is hidden on your PC

## Chapter 5 APPLICATION

8 Click "Update Program" in the dialog box to continue.

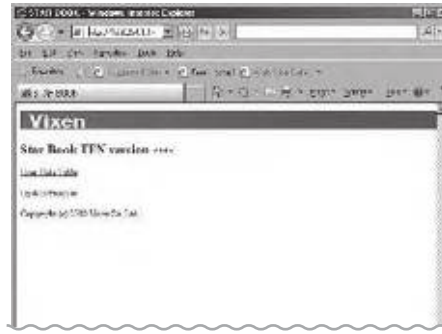

9 Updating will advance in the following procedure.

Open the holder that contains the downloaded program file for updating.

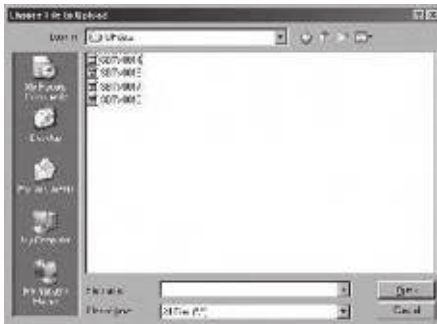

Select the program file and click it to open.

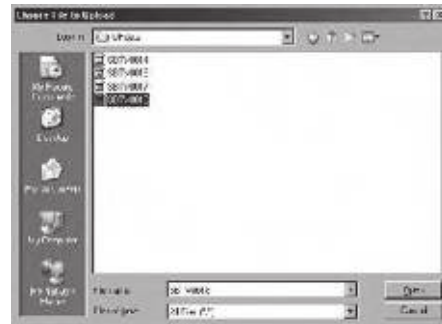

Click on Submit Query button for sending the program file



Progress of the update is displayed on the screen of the STAR BOOK TEN during the communication with the PC.

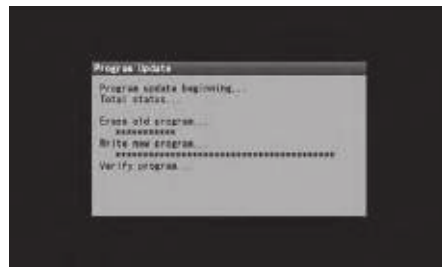
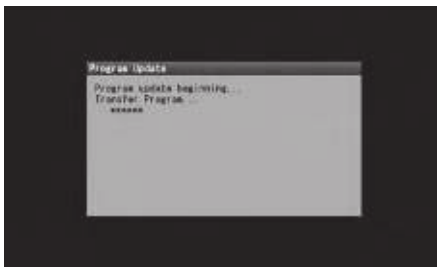

The message below appears during communication with the STAR BOOK TEN.



You will see this screen at the end of successful update.



10 When you have successfully updated your STAR BOOK TEN you will see the "Update Finish" message on your screen. This can also be confirmed on the screen of the STAR BOOK TEN. Unplug the power supply cord of the STAR BOOK TEN and then plug it in again to reboot.

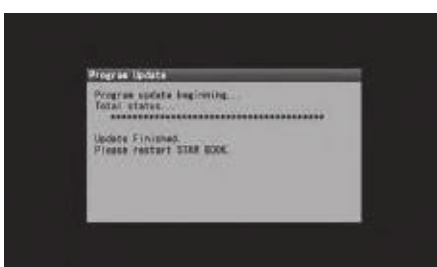

## Chapter 5 APPLICATION

### VI. Entering Orbital Elements and User Defined Objects

The STAR BOOK TEN allows you to store orbital elements of comets and artificial satellites as well as user defined objects up to 10 of each for tracking and Go-To slewing. You need to prepare orbital elements for this purpose.

#### Procedures

- 1 Directly connect the STAR BOOK TEN and a PC with the LAN crossover cable. At this stage, do not power the STAR BOOK TEN.
- 2 Turn ON the STAR BOOK TEN by connecting a power supply cord to it.
- 3 Turn ON the PC to begin communication.
- 4 Wait for a period of one minute as the STAR BOOK TEN and PC will automatically acquire information on networking.
- 5 At the main menu, choose About "LAN" and press **ENTER**.

Confirm the IP address is indicated as follows:

IP Address: 169.254.a.b (a and b are indefinite numbers)

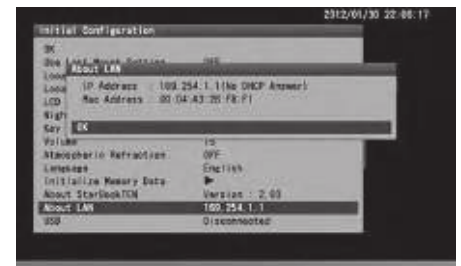

#### CAUTION

- \* Never disconnect the power supply cord for the STAR BOOK TEN and the LAN crossover cable while the STAR BOOK TEN is in communication with the PC. This could result in unrecoverable damage.
- \* The IP address may differ if the STAR BOOK TEN is connected indirectly through a network.
- \* If the connection to the PC does not finish, the message "Waiting..." will be displayed instead of the IP address. Or, if the connection ends in failure, the message "Disconnected" will be displayed. If this is the case, wait a little while or make sure that the LAN crossover cable is connected securely.

- 6 Open Internet Explorer (or your internet browser) and enter the IP address you obtained in the above in the address bar to display an entry page. The following appears on the screen.

#### Example:

If the IP address is 169.254.1.1, put <http://169.254.1.1> on the address bar.

**Note:** Change the setting to have the address bar appear if it is hidden on your PC



## Chapter 5 APPLICATION

7 Click "User Data Table" in the dialog box to continue.

Clicking a number of an available space for an object (for comet, artificial satellite and user defined object) will display an entry dialog box. Available space for a name is a total 14 of single-space characters. Do not use capital letters for the name.

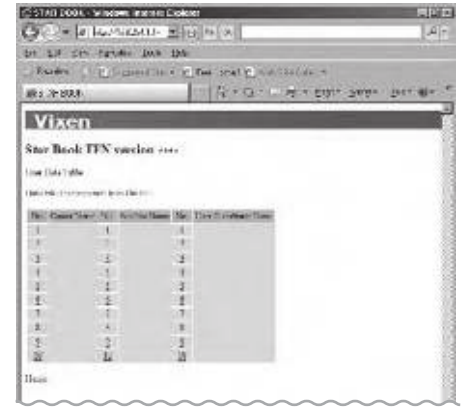
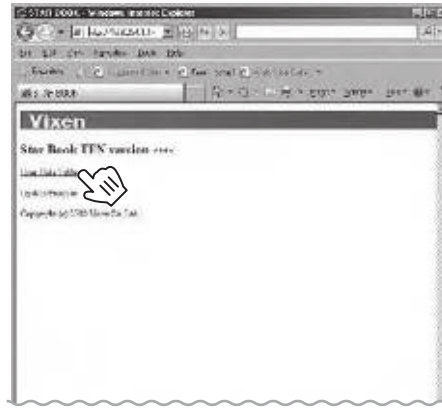

Usable letters and characters are as follows:

! , # \$ % & ' ( ) \* + , - . / 0 1 2 3 4 5 6 7 8 9 ; < = > ? @ A B C D E F G H I J K L M N O P Q R S T U V W X Y Z [ \ ] ^ \_ ` a b c d e f g h i j k l m n o p q r s t u v w x y z { | } ~

The dialog box below will appear if you choose to enter orbital elements for comet.



The dialog box below will appear if you choose to enter orbital elements of artificial satellites.



The dialog box below will appear if you choose to enter a user defined object.

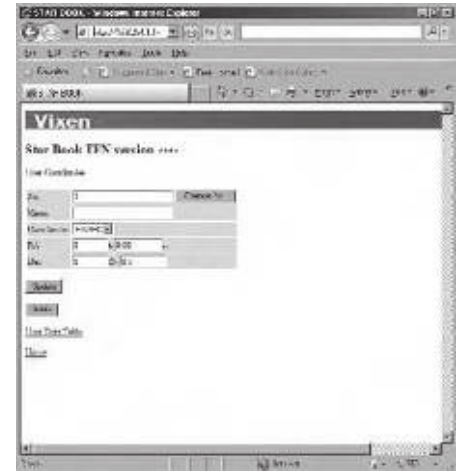

The following is an example of how to input data by using the comet McNaught.

1 Prepare the orbital elements.

Name	: McNaught 2009 K5
Time of perihelion passage (T)	: 2010.4.30.02286 (YY/MM/DD/TT)
Argument of perihelion( $\omega$ )	: 66.17274°
Longitude of the ascending node ( $\Omega$ )	: 257.85578°
Inclination (i)	: 103.87956°
Minimum distance from perihelion (q)	: 1.4223935 AU
Eccentricity (e)	: 1.0008525
Epoch	= 2010.5.4.0 (YY/MM/DD/TT)

2 Fill in the name and orbital elements of the comet in the dialog box and click on the Update button to enter.



3 Clicking "Data File Transmission from the file" in the dialog box will allow you to confirm that the orbital elements of the comet are saved.

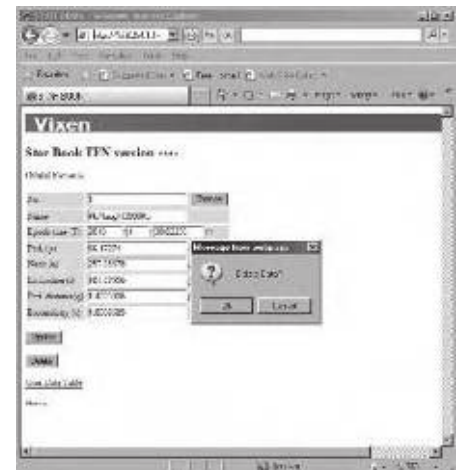
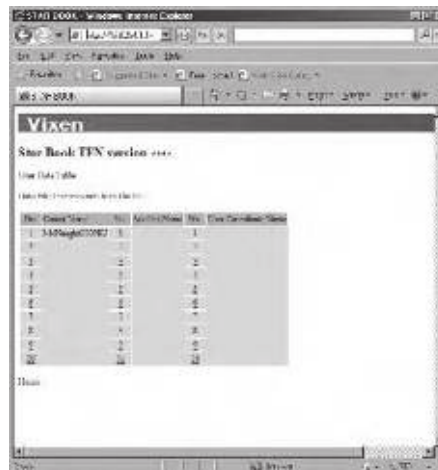

If you want to delete the orbital elements, click on the Delete button. It is not possible to restore the data once deleted.

## Chapter 5 APPLICATION

Alternatively, you can make a list of the orbital elements and send it to the STAR BOOK TEN. You need to prepare the list in text file format for this purpose. Read page 96 on how to make it.

**Note:** Previous data in the same line numbers will be overwritten by the new information.

- 1 Click "Data File transmission from the file" to access the entry dialog box.

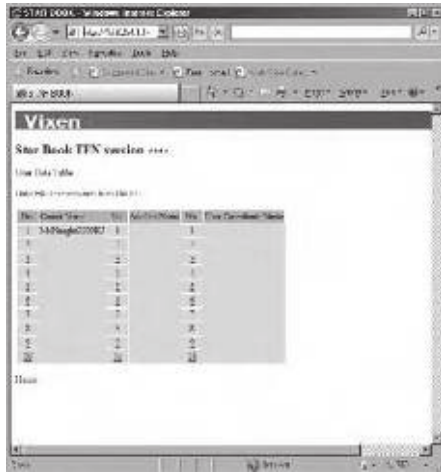

- 2 Click on the Browse... button to continue.

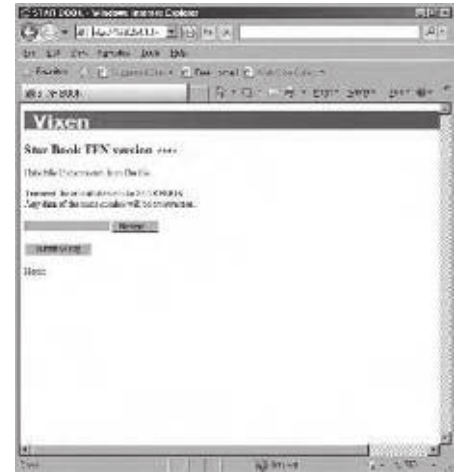

- 3 Designate a folder that contains files of the orbital elements for comet, artificial satellite and user defined object.



- 4 Point to a file of the orbital elements and click it to open.



- 5 The message below appears during communication with the STAR BOOK TEN.



- 6 You will see the message below at the end of a successful transmission.

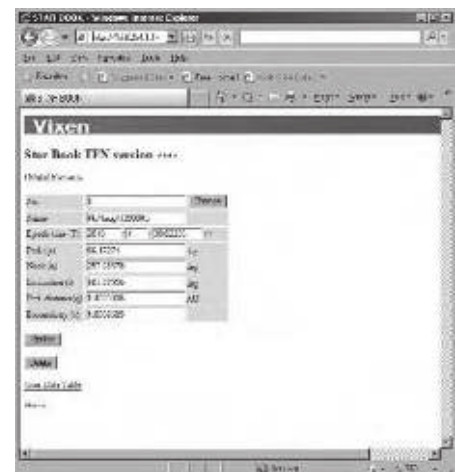

## Chapter 5 APPLICATION

### Data Transmission Forms

Apply the following structure to create a list of the orbital elements. Send it to the STAR BOOK TEN by text file.

#### Form of Orbital Elements for Comet

STARBOOKCOMETFILE

Line number, Name of comet, Time of periapsis passage (T) (YY/MM/DD/TT), Argument of periapsis( $\omega$ ), Longitude of the ascending node ( $\Omega$ ), Inclination ( $i$ ), Minimum distance from periapsis ( $q$ ), Eccentricity ( $e$ ).

Example

STARBOOKCOMETFILE									
			(T/MM)						
1,	McNaught	2010R1,	2010	.6	.2.67841	.130.70095,	322.62188,	77.03226,	0.4050263,1.0003431
↑	↑	↑	↑	↑	↑	↑	↑	↑	↑
Line number	Name of comet	(T/YY)	(T/TT)	( $\omega$ )	( $\Omega$ )	( $i$ )	( $q$ )	( $e$ )	

### CAUTION

- \* The text of "STARBOOKCOMETFILE" identifies the orbital elements of comet. Do not change this part.
- \* Fill in all the items for entry. All items must be completed to have the data accepted.
- \* Do not use letters and characters other than the ones usable on the STAR BOOK TEN.
- \* Use a ","(comma) between each entry.
- \* You may not leave space between the lines.
- \* The line numbers must be labeled from 1 and 10.

#### Form of Orbital Elements for Artificial Satellite (TLE format)

STARBOOK SATELLITE FILE

Line number, Name of satellite

1 AAAAAABBBBBBCCCCC.CCCCCCCC±.DDDDDDDEEEEE-EFFFF-FGHHHH  
2IIIIJJJ.JJJJKKK.KKKLLLLLLLLMMM.MMMMNNN.NNNNOO.OOOOOOOPPPPP

Example

1,	I S ← Name of satellite									
↑										
Line number	A	B	C	D	E	F	G	H		
1	25544U	98067A	10111.53413738	.00016717	00000-0	10270-30	9027			
2	25544	51.6459	161.3425	0003532	195.5452	164.5604	15.75083651	14550		
	↑	↑	↑	↑	↑	↑	↑	↑	↑	↑
	I	J	K	L	M	N	O	P		

### CAUTION

- \* The text of "STARBOOKSATELLITEFILE" identifies the orbital elements of artificial satellite. Do not change this part.
- \* Fill in all the items for entry. All items must be completed to have the data accepted.
- \* NORAD two-line element is applicable.
- \* Do not use letters and characters other than the ones usable on the STAR BOOK TEN.
- \* Use a ","(comma) between each line number and name of satellite.
- \* You may not leave space between the lines.
- \* The line numbers must be labeled from 1 and 10.



## Chapter 5 APPLICATION

### Form of User Defined Object

Choose from the following two types of formats according to coordinates you use.

#### RA.DEC

STARBOOKCOORDFILE

Line number, Name of Object, Type of coordinates, RA in hour, RA in minute, RA in second, DEC in degree, DEC in arc minute

#### ALT.AZ

STARBOOKCOORDFILE

Line number, Name of point, Types of coordinates, Azimuth in degree, Azimuth in arc minute, Altitude in +/- degree, Altitude in arc minute.

Example

S T A R B O O K C O O R D F I L E							RA(s)	RA(s)	DEC(±°)
5	, V i x e n S t a r 0 1 ,	R A D E C ,	1 2 ,	2 3 ,	4 5 ,	6 7 ,	8 9 .	6	
↑	↑	↑	↑	↑	↑	↑	↑	↑	
Line number	Name of Object	Type of coordinates	RA(h)	Azimuth(°)	Altitude(±°)	DEC(')			
6	, M t . V i x e n S u m m i t ,	A L T A Z ,	2 7 5 ,	1 2 ,	1 ,	1	←Altitude(°)		
↑	↑	↑	↑	↑	↑	↑	↑		
Line number	Name of point	Types of coordinates	Azimuth(°)	Altitude(±°)					

## CAUTION

- \* The text of "STARBOOKCOORDFILE" identifies the user defined object. Do not change this part.
- \* Fill in all the items for entry. All items must be completed to have the data accepted.
- \* Do not use letters and characters other than the ones usable on the STAR BOOK TEN.
- \* Divide between line number and name of satellite with a ","(comma).
- \* You may not leave space between the lines.
- \* The line numbers must be labeled from 1 and 10.

## Example

Making a text data file called "Observation\_data.txt"

STARBOOKCOMETFILE

```
1, McNaught2010R1, 2010,6,2.67841, 130.70095, 322.62188, 77.03226, 0.4050263, 1.0003431
2, LONEOS2006S3, 2012,4,16.33376, 140.12907, 38.36874, 166.03253, 5.1310903, 1.0034881
```

STARBOOKSATELLITEFILE

```
1,ISS
1 25544U 98067A 10111.53413738 .00016717 00000-0 10270-3 0 9027
2 25544 51.6459 161.3425 0003532 195.5452 164.5604 15.75083651 14550
2,NOAA 1
1 04793U 70106A 10137.05933165 -.00000031 00000-0 10000-3 0 5187
2 04793 102.0931 138.9934 0031991 161.7350 198.4876 12.53938420804769
```

STARBOOKCOORDFILE

```
5, VixenStar01,RADEC,12,23,45,67,89.6
6, Mt.VixenSummit,ALTAZ,275,12,1,1
```

- \* "VixenStar01" and "Mt.VixenSummit" are imaginary names do not exist.
- \* The data shown above is current at the time of publication. Always obtain the latest data for observing

The warning message below will be indicated on the screen if there is a communication error or incorrect data format.



Make sure that your data for the orbital elements are completed in compliance with the designated format. Check the LAN cable is connected securely and then try again by restarting the internet browser and the STAR BOOK TEN.

# APPENDIX

## Connectors on the STAR BOOK TEN

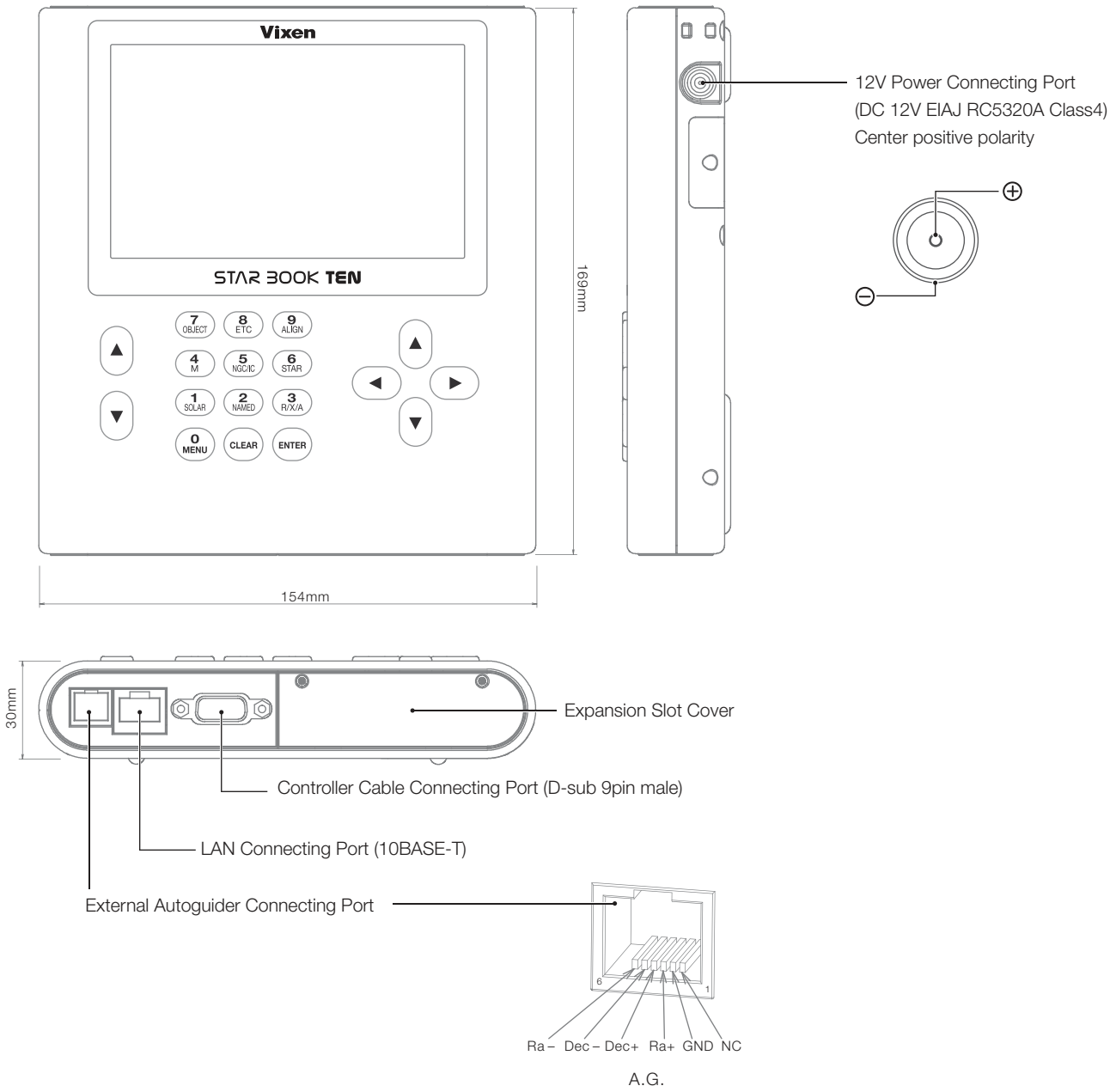

## Connectors on the SxD2 Mount

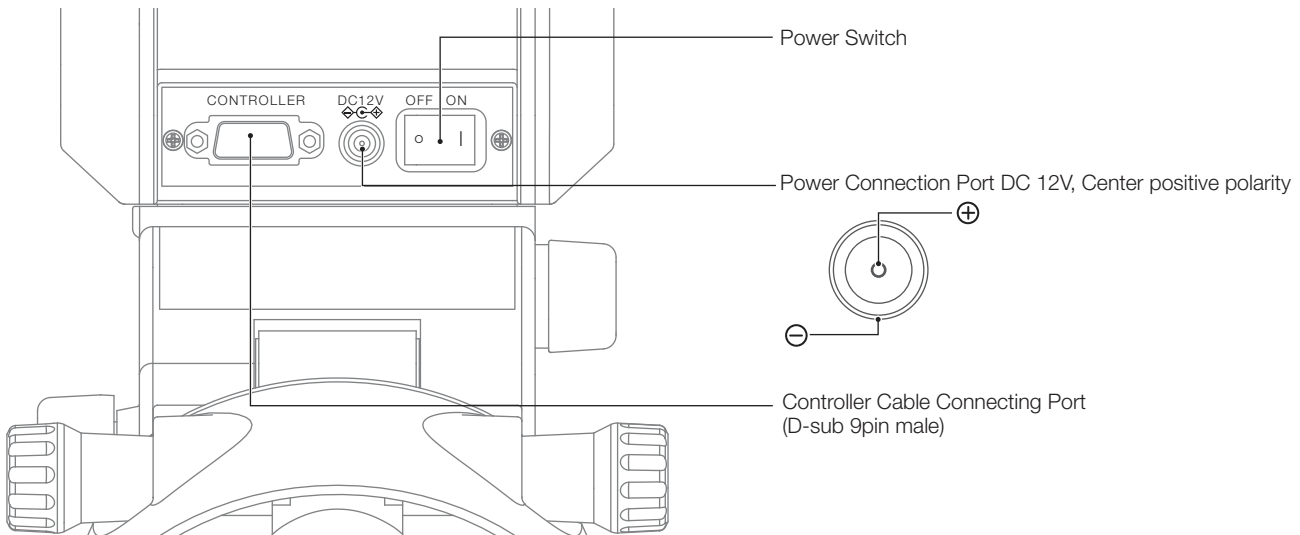

# APPENDIX

## Dimensions of the SXD2 Mount

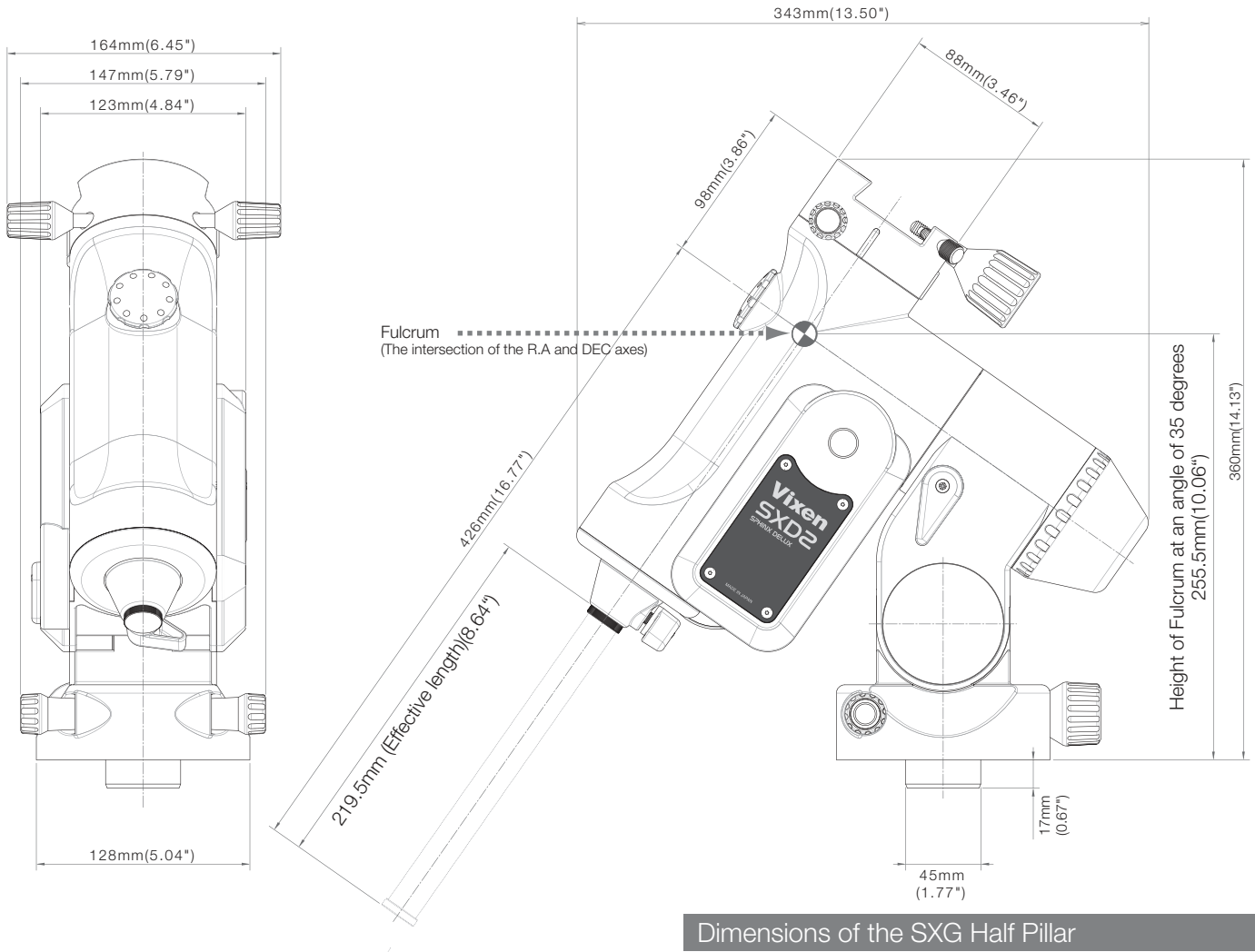

## Dimensions of the SXG Half Pillar

(Sold separately)

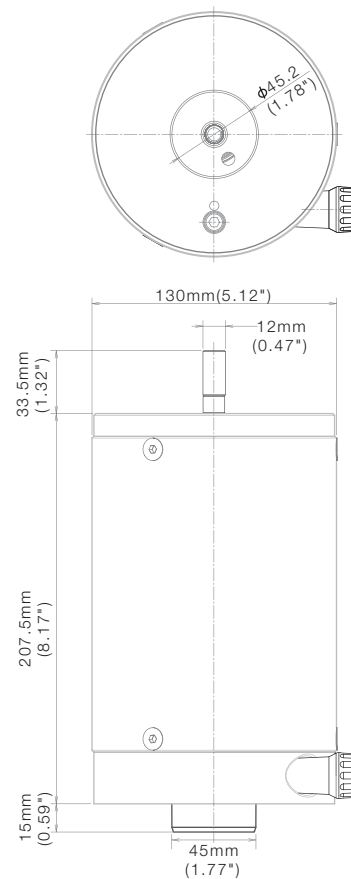

# APPENDIX

## Dimensions of the SXG-HAL130 Tripod

(Sold separately)

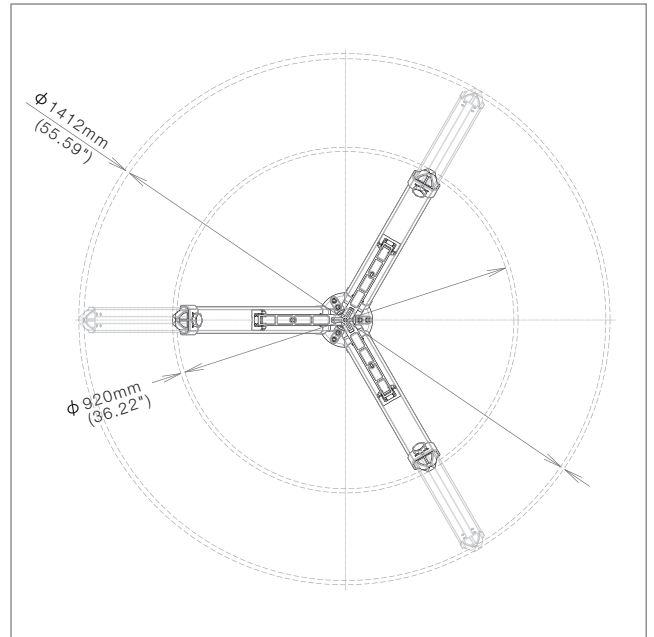
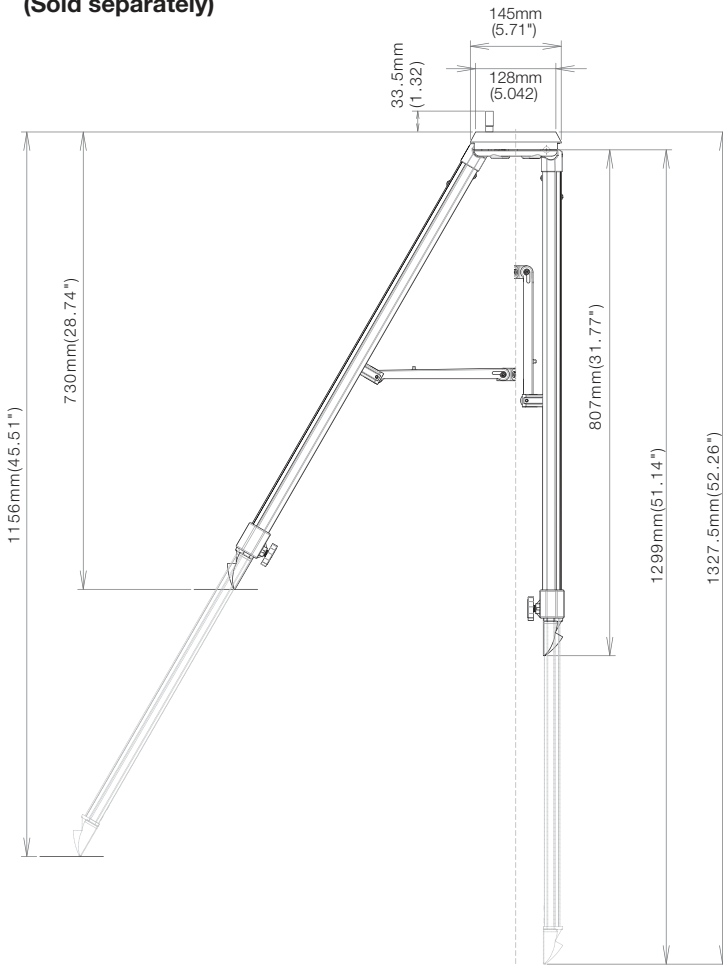

## Dimensions of the SXG-P85DX Pillar

(Sold separately)

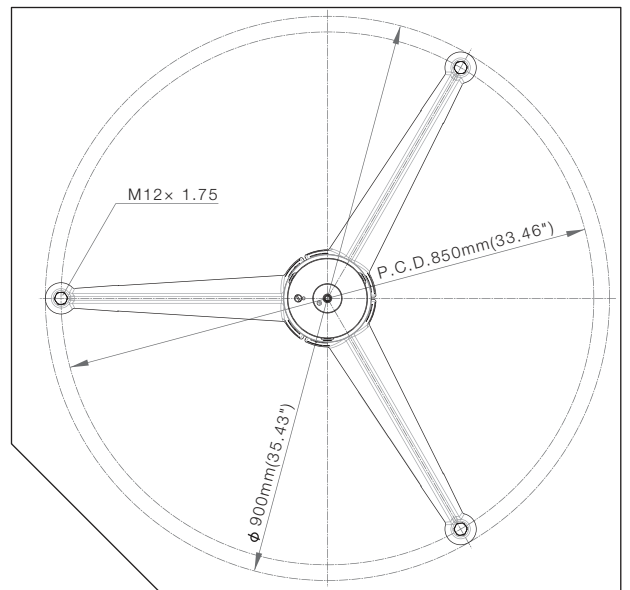
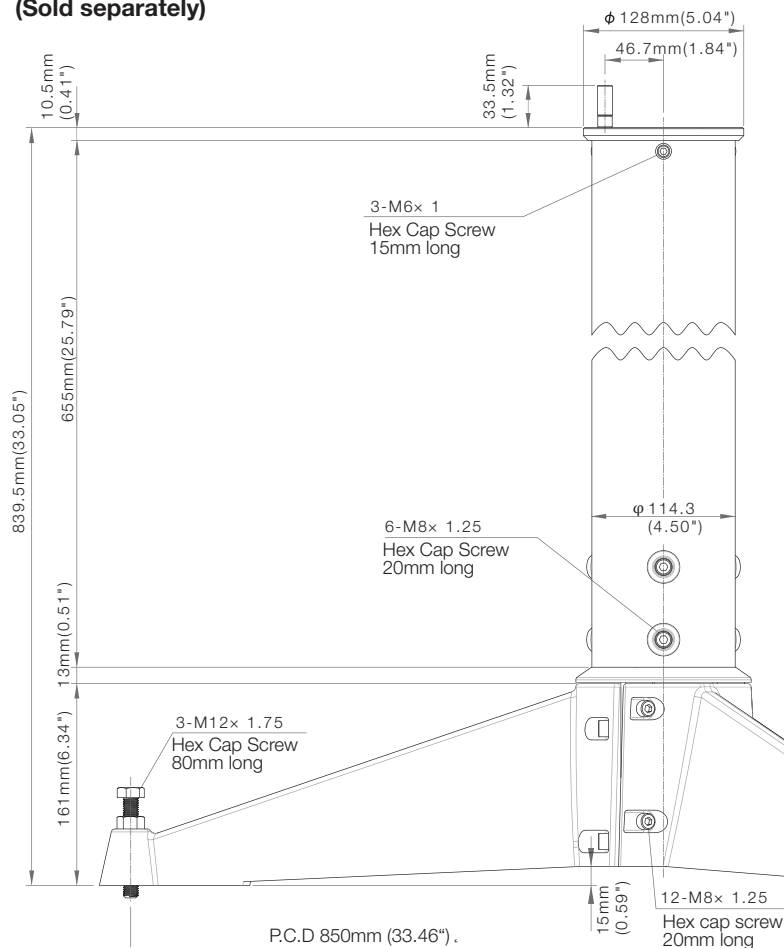

\*Actual dimensions may differ slightly on your product.  
\*The specifications are subject to change without notice.



# Vixen®