

**CARSON®**

# Smartphone Microscope Adapter

**Included with:**

- MS-160SP Biological Microscope

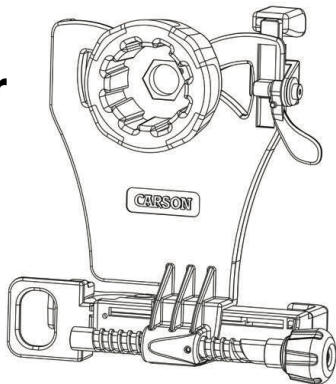

## ***Instructions for Use***

↓ PDF / ▶ VIDEO : [www.carson.com/microscopic](http://www.carson.com/microscopic)

English / Français / Español / Deutsch / 日本語

HookUpz™

## Table of Contents

Optic Side Diagram.....	2
Phone Side Diagram.....	3
Inserting Phone.....	4-5
Align & Lock.....	6-7
Attaching to Optic.....	8-9
Frequently Asked Questions.....	10-13
Tips and Tricks.....	14
Storage/Cleaning Information....	15
Customer Service.....	15

**Carson Optical**  
**2070 5th Avenue**  
**Ronkonkoma, NY 11779**

**www.carson.com    info@carson.com**  
**Tel: 631-963-5000    Fax: 631-427-6749**

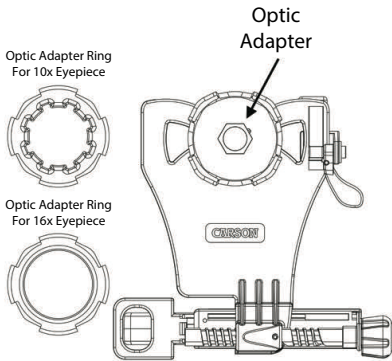

## Optic Side

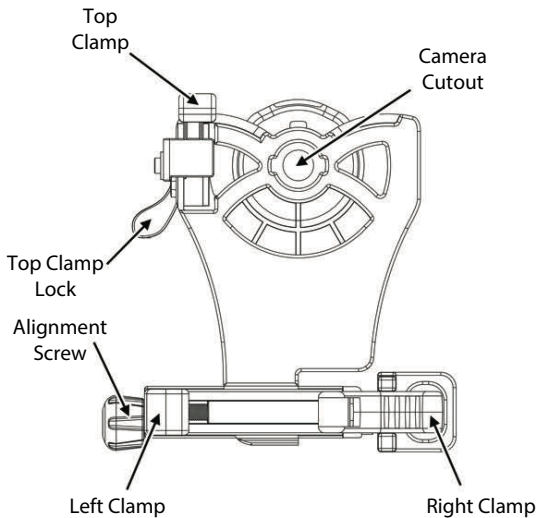

## Phone Side

# Inserting Phone

**Fig.1**

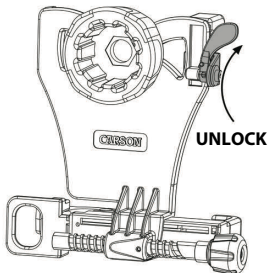

Rotate to unlock top clamp.

**Fig.2**

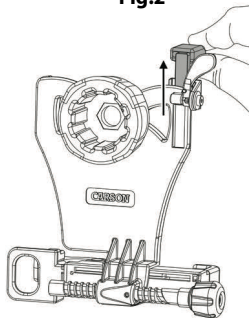

Slide top clamp into uppermost position.

**Fig.3**

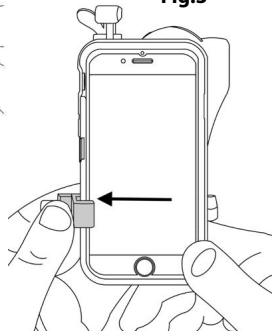

Insert phone into left clamp.

# Inserting Phone (cont.)

**Fig.4**

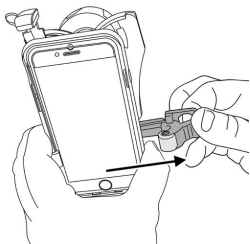

Squeeze and pull right clamp past edge of phone.

**Fig.5**

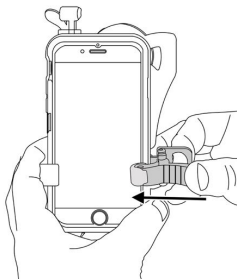

Release right clamp to secure phone.

**Fig.6**

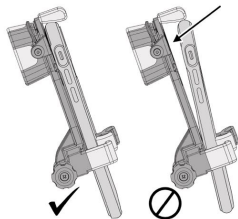

Ensure phone is flat as possible to adapter.

# Align & Lock

**Fig.7**

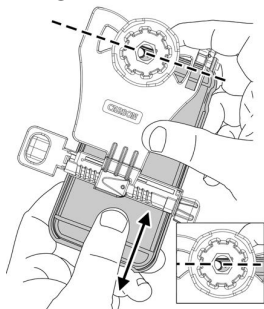

Slide phone vertically until camera is roughly aligned with camera cutout.

**Fig.8**

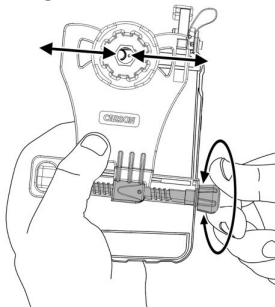

Turn alignment screw until camera is centered in camera cutout.

**Fig.9**

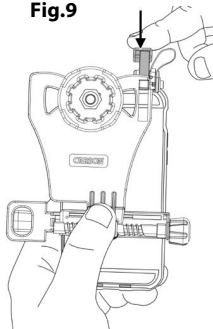

Slide top clamp down against phone edge.

# Align & Lock (cont.)

## **MULTIPLE-LENS CAMERA PHONE:**

If there is more than one rear-facing camera, use the primary one.

Typically, the primary is a 1x wide-angle color camera, and the other camera(s) are secondary.

For Apple dual camera phones, the primary camera is the one closest to the corner. Use photo or video mode only.

For Android, the primary camera can be determined by which does not show an image in your app while blocking the individual camera.

For the latest instructions on multiple camera phones, please visit [www.carson.com/multicam](http://www.carson.com/multicam).

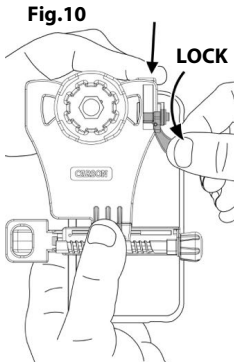

While holding top clamp tight to phone, rotate to lock.

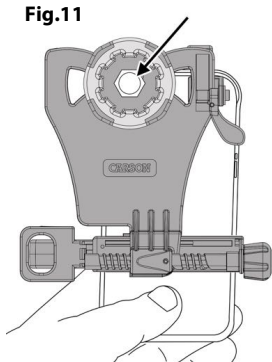
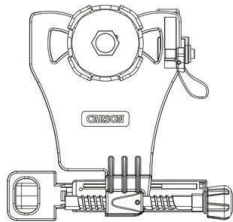

Figure 11 shows a properly aligned camera. If needed, use alignment screw and top clamp to make further adjustments.

# Attaching to Optic

Fig.12



Optic Adapter Ring  
For 10x Eyepiece



Optic Adapter Ring  
For 16x Eyepiece



Select the ring the fits the eyepieces you will be using and insert it into the optic adapter.

Fig.13

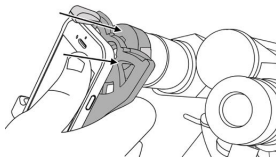
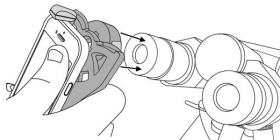

Align optic adapter over eyepiece and press down firmly. Be careful not to move your camera out of alignment.

Fig.14

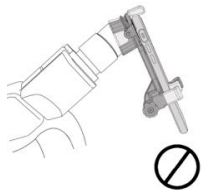
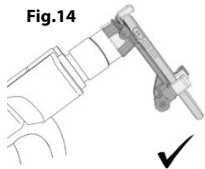

Ensure that optic adapter is flush to the eyepiece of your microscope.



## Attaching to Optic (cont.)

**Fig.15**

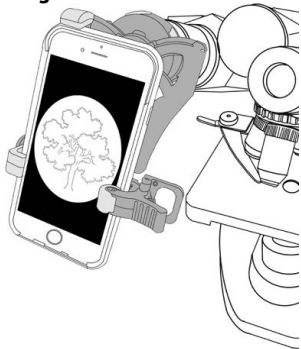

Turn on camera. If image is not centered, repeat alignment steps.

**Fig.16**

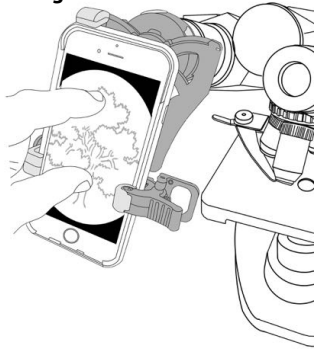

To maximize your image, pinch to enlarge image. For best results, use in video mode.

### **TO REMOVE PHONE FROM ADAPTER:**

To save your alignment, make no further adjustments to the top clamp and alignment knob. Simply remove phone using right clamp only as shown in Fig. 4.

### **USING ADAPTER AGAIN:**

The alignment of your phone to the adapter should be saved from the initial setup, so many steps can be skipped (FIG 1-2, 7-10) and only a quick fine adjustment of the alignment may be needed.

## **Frequently Asked Questions:**

**Q1:** Why does the top clamp touch the round corner of my phone, instead of the top flat edge?

**A1:** This is normal for some models of phones. Just fit as close to rounded edge as possible and lock top clamp as normal.

**Q2:** Why am I getting reflections and/or glare in my image?

**A2:** This may occur with indoor lighting. Please avoid overhead lighting or change the angle of the lighting relative to phone. Also, please use without flash to avoid reflections and/or glare in photos. If there's glare on your phone screen that makes image hard to view, increase brightness setting on phone and view from a position with less overhead light.

**Q3:** I can't align my phone vertically with the top clamp; it won't fit. What should I do?

**A3:** If you go through the alignment process and there is no way to achieve vertical alignment, because it's restricted by the top clamp, try removing your phone case. Alternatively, you can remove top clamp assembly using screw as shown below in left figure. For this configuration, you will not be able to save your vertical alignment between uses. Your phone will have to be adjusted for vertical positioning each time it's placed within the adapter. We recommend you save these four parts for use with other phones, and you can reassemble the top clamp as shown below in right figure.

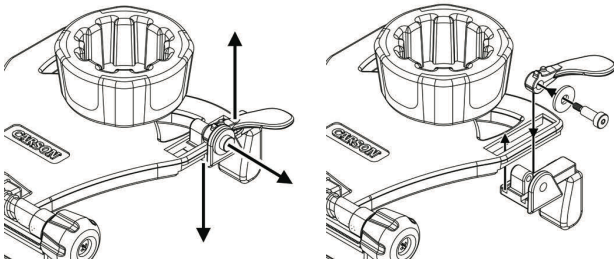

**Q4:** How do I know which phones will work with the adapter?

**A4:** Please see the smartphone sizing guide below.

## SMARTPHONE SIZING GUIDE

A dark grey rounded rectangular box contains the text "SMARTPHONE SIZING GUIDE". Two vertical arrows point downwards from the bottom corners of the box, defining a central space for the text below.

If your phone (in its case) fits in "portrait" orientation between the 2 arrows, it will fit the smartphone microscope adapter.

**Q5:** Why does my phone rotate on the eyepiece when used in landscape (horizontal) mode?

**A5:** Using the adapter in landscape mode is not recommended unless the microscope eyepieces can be securely locked to prevent rotating.

**Q6:** My image doesn't appear to be centered or is not a complete round image; what's wrong?

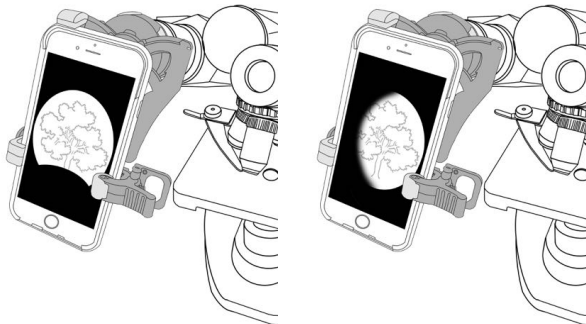

**A6:** The phone alignment needs to be adjusted in vertical direction using top clamp (FIG 7) and in horizontal direction by using alignment screw (FIG 8). Check that phone is flat on adapter (FIG 6), and adapter is flush with optic.

**Q7:** My other phone camera or flash is covered by adapter. Why is that?

**A7:** First, we recommend using the device with only the primary rear camera. If problems persist, please contact customer support. Second, the flash can be covered, and is not needed for use with optic. We recommend flash setting is turned off at all times when using adapter.

# Tips & Tricks:

## PHOTOGRAPHY

- Tap object of interest on your phone screen to autofocus.
- For videos, tap and hold object of interest on phone screen for a second to lock focus. Tap again to release the focus lock.
- In low light conditions, turn your phone screen brightness to its lowest level.
- For long sessions, try using battery cases or phone chargers to prevent your battery from draining.

## APPS

- Share photos and videos through various apps (e.g. FaceTime, Messages, Facebook, Instagram, etc.)
- Apps that allow you to set exposure and focus manually can expand the potential of the adapter.

## STABILIZATION

- Place microscope on a stable surface to prevent external vibrations from shaking image.
- To prevent shaking while capturing photos, attach headphones to smartphone and use the volume buttons to activate shutter.
- Many phones have image stabilization features. Check your phone and turn on this feature if available. If not, there are camera apps with stabilization features.

## **Storage/Cleaning Information:**

- For longest life of springs/plastic, store in dry area at room temperature.
- Adapter should be cleaned with soft, damp cloth only. Do not use any chemicals or abrasives.

## **Customer Service:**

We will be happy to help you with any problems you may experience with your HookUpz™ Smartphone Microscope Adapter. Email us at [info@carson.com](mailto:info@carson.com) or call toll-free at 1-800-967-8427.

**CARSON®**

**Carson Optical  
2070 5th Avenue  
Ronkonkoma, NY 11779**

**www.carson.com   info@carson.com  
Tel: 631-963-5000   Fax: 631-427-6749**