

PRECISION MOTION CONTROLLER

iEXOS 100  
INSTRUCTION MANUAL

EXPLORE<sup>®</sup>  
SCIENTIFIC

Ver. 01.7 – June 2019

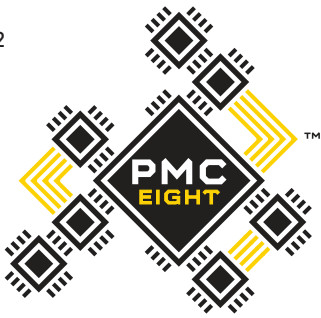

PRECISION MOTION CONTROLLER

▶ WELCOME TO THE WORLD OF EXPLORATION.



You've found the perfect spot on the perfect night, and your eyepiece is waiting to unveil celestial treasures. Instead of diving right into observing or imaging, you can quickly whittle away precious time manually hunting for a specific object or even determining what sights might be viewable from your location.

With the PMC-Eight OpenGOTO system in your arsenal of astronomical tools flawlessly navigating the skies has never been easier. Designed to meet the versatile needs of astronomers of all levels, this advanced GOTO system is a clean slate approach to precision motion control technology that maximizes the potential of your optical equipment.

The robust electronics that power the PMC-Eight include eight CPUs that are independently dedicated to performing set functions. This devotion to task translates into a reliable system that responds rapidly and operates smoothly. The complexities of the electronics, which are conformal coated for protection against contaminants and harsh environments, are easily managed with our own intuitive ExploreStars app or through the ASCOM-powered planetarium software of your choosing.

Although the electronics of the PMC-Eight make it a clear standout for robotic telescope control, it is the open source coding that makes our system truly revolutionary. We feel that by making our software open source, we can discover exhilarating uses and encourage innovative thinking. We invite developers of all levels to become an active part of the OpenGOTO community by downloading our coding and exploring the PMC-Eight's unlimited possibilities.

## Table of Contents

WELCOME	3
WARRANTY	3
THANK YOU	6
QUICK START	7
iEXOS 100 MOUNT ASSEMBLY	8
CONNECT THE PMC-EIGHT	12
POLAR ALIGNMENT PROCESS	14
EXPLORESTARS APP	16
ASCOM	19
PROGRAMMERS	22
SHARE THE SKY	23
PROPER CARE	24

## Explore STAR Warranty

To activate the limited one-year warranty on qualified products, simply register the product with Explore Scientific within 60 days of purchase.

To complete your registration, select one of the following options:

- Visit: <https://explorescientific.com/product-registration>
- Mail in the enclosed registration card
- Call our Customer Service Center at (866) 252-3811

To purchase an extended warranty, please contact Customer Service.



## ▶ REVOLUTIONARY

The PMC-Eight has taken GOTO technology to a whole new level by utilizing a smart electronic design that transcends the industry standard single processor. The PMC-Eight has eight CPUs that operate independently of one another to focus on defined functions. This delegation of tasks among the processors results in a system that offers superior responsiveness, efficiency and reliability. This multiple processor approach is a revolutionary one that pays off with exceptional performance.



## ▶ INTUITIVE

Created specifically for the PMC-Eight, the ExploreStars app streamlines the observing experience and serves as an ideal introduction to the many benefits of our OpenGOTO system. ExploreStars is all-encompassing and has an intuitive nature that makes it simple and quick to align your telescope, navigate the stars and learn specifics about tens of thousands of celestial objects. This dynamic app is fueled by a database that is routinely updated to ensure it remains a relevant resource.



## ▶ VERSATILE

Although we offer our own operating app, the PMC-Eight is all about providing options – not only in what you view but in how you get there. To meet the versatile needs of our astronomy community, we have made the PMC-Eight compatible with the industry standard ASCOM interface. Our specific driver allows you to use the ASCOM-powered planetarium software of your choosing to run the PMC-Eight either wirelessly or through a wired connection. Through ASCOM, you can access a number of outstanding resources including the American Astronomical Society's acclaimed WorldWide Telescope.



## ▶ LIMITLESS

The night sky is full of possibilities, and so is the PMC-Eight. In an unprecedented move, we have made the coding that powers our precision motion control system open source. By putting the building blocks into the hands of programmers, we believe we will unlock the full potential of the PMC-Eight OpenGOTO and discover unexplored uses. We don't want to set limits and force users to conform to our vision. Instead, we want to give you the access you need to make this system your own.

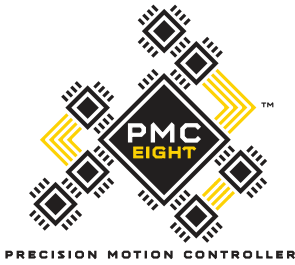

**EXPLORE**<sup>®</sup>  
SCIENTIFIC

**We would like to thank you for choosing Explore Scientific<sup>®</sup>'s PMC-Eight<sup>™</sup> Open GOTO system to be your personal guide to the universe.**

Since 2008, we have been on a mission to make astronomy accessible and provide a truly transformative experience by giving people the tools and guidance they need to explore the skies. The PMC-Eight is the latest manifestation of our unwavering commitment to this goal.

Powered by open source software, this revolutionary precision motion control system was engineered to meet the diverse needs of the astronomy community. For beginners, the intuitive design works hand-in-hand with our ExploreStars app to make it easy to smoothly navigate and learn about the night sky. For more advanced users and programmers, the open source coding allows for a fully customizable experience.

No matter where you are in your astronomy journey, the adventures this versatile system can send you on are immeasurable. We encourage you to enjoy it fully, use it often and truly make it your own.

We are thrilled to share the PMC-Eight and its open source code with you, and we want to ensure that you have the experience you deserve. Please do not hesitate to contact our Customer Service Center with your questions or suggestions through an online chat at [www.explorescientificusa.com](http://www.explorescientificusa.com) or by calling (866) 252-3811.

Clear skies,

A handwritten signature in black ink, appearing to read 'SR', with a long horizontal line extending to the right.

Scott Roberts  
President and Founder  
Explore Scientific<sup>®</sup>, LLC

A handwritten signature in black ink, appearing to read 'Robert Price', with a long horizontal line extending to the right.

Robert Price  
COO  
Explore Scientific<sup>®</sup>, LLC

## iEXOS 100 WITH PMC-Eight™ System Quick Start Guide

Although the iEXOS 100 with PMC-Eight is a complex precision motion control system, it is simple to set up.

### Contents

- iEXOS 100 Mount (With built-in PMC-Eight system)
- Tripod
- DC power supply with cable
- RJ-12 WiFi Channel Switch Dongle
- One motor cable
- Two 1 kg counterweights
- Set-up manuals

### Step 1: Choose Your Platform

Before using the PMC-Eight, you will need to select and load your operating program of choice to your device. Our intuitive ExploreStars app can be downloaded for free from the Microsoft Store or Google Play for Android devices and the App Store for iOS devices. The iOS install requires no further action. For Windows and Android, once installed, you will simply download the object database from [www.explorestars.com](http://www.explorestars.com) and you are ready to go. For those that already have a favorite third-party planetarium program, the PMC-Eight has an ASCOM driver. For more information on the ExploreStars app or the ASCOM driver, please see the individual manuals. For video tutorials on installing the app and/or driver, visit [www.explorescientific.com/pmc-eight/](http://www.explorescientific.com/pmc-eight/)



### Step 2: Assemble the iEXOS 100 Mount and connect the PMC-Eight

Assemble the tripod and insert the mount into the top of the central column. Secure the mount to the tripod by twisting the tension knob until snug. After assembling the mount, attach and balance your telescope. Once that is completed, attach the motor cable to the appropriate ports. Install 8 C batteries into the power pack and insert the pack into its holder on the tripod leg. Attach the cord running from the power supply into the appropriate PMC-Eight port. Connect to the PMC-Eight wirelessly through your device. For more information on connecting the PMC-Eight, please see the full manual. For a video tutorial on the set-up process, visit [www.explorescientific.com/pmc-eight/](http://www.explorescientific.com/pmc-eight/). Additional power options are available through Exlore Scientific.

### Step 3: Align Your Telescope

Before using the PMC-Eight, you will need to align your telescope. You can do this using a traditional physical, manual alignment process or by using the virtual 2, or 3-star alignment procedure in the ExploreStars app. It is important to remember that the better your physical alignment is, the better the system will perform. For a video tutorial on the alignment process, visit [www.explorescientific.com/pmc-eight/](http://www.explorescientific.com/pmc-eight/)

### Step 4: Choose an object and start exploring!

#### Additional Support

If you have questions about operating the PMC-Eight, please do not hesitate to contact our Customer Service Center for an online chat at [www.explorescientificusa.com](http://www.explorescientificusa.com) or by calling (866) 252-3811. For Frequently Asked Questions about the PMC-Eight, visit the Knowledge Base page at [www.explorescientific.com/knowledgebase](http://www.explorescientific.com/knowledgebase) and open the PMC-Eight Questions folder.

## iEXOS 100 Mount Set Up

1)

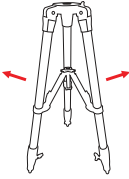

3)

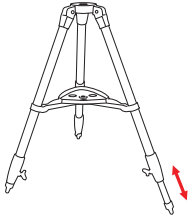

5)

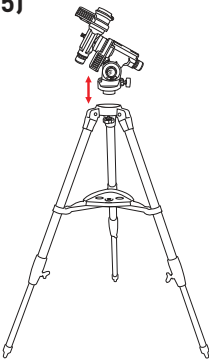

2a)

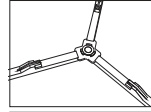

2b)

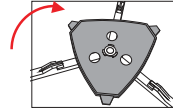

2c)

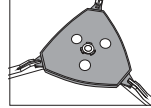

4)

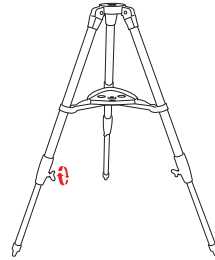

6)

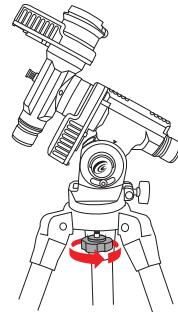



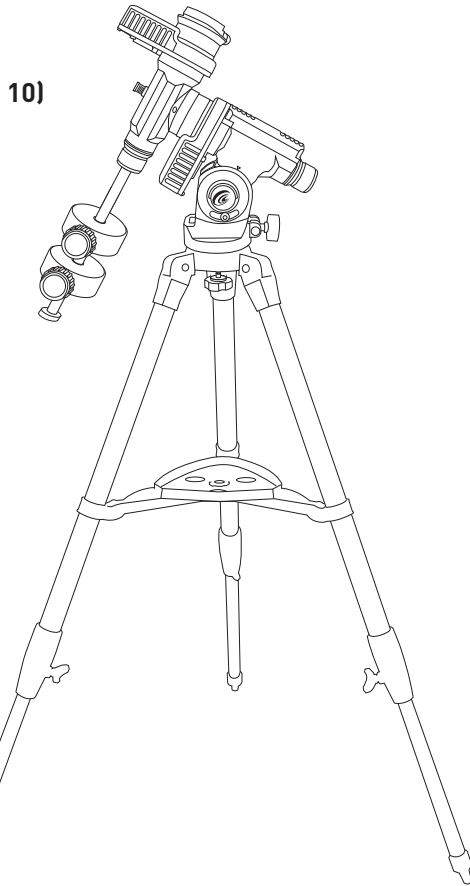
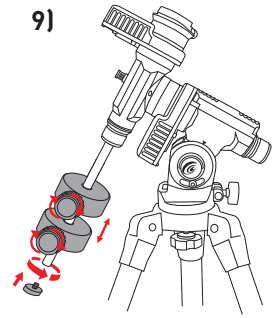
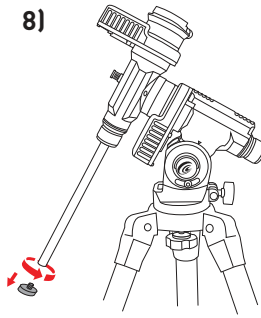
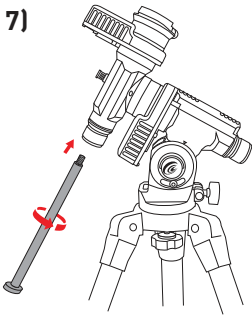



### Parts List

1. iEXOS 100 Mount  
(With built-in PMC-Eight system)
2. 8 C Battery DC power supply with cable  
(batteries not included)
3. Battery pack mounting bracket
4. ST4 (RJ-12) WiFi Channel Switch Dongle
5. DB9 to RJ-25 DEC Cable
6. Two 1 kg counterweights
7. Glow in the dark indicators

## Checking The Parts

Remove all the parts from their respective boxes and place them on a flat, clear work area. A large floor space is ideal. When setting up your iEXOS 100 mount you must start with the tripod and work from there. To insure proper assembly, each task must be performed in the specific order as defined by these instructions.

## Assembling The Tripod

The tripod comes fully assembled. Stand the tripod up and spread the legs until they are evenly distributed. To raise or lower the tripod legs, unlock the large knobs at the bottom of each leg and lift the interior leg to the desired height and re-lock the large knobs until snug. It is recommended that you set the tripod height to the desired level you plan to use the mount and scope together. It is also recommended to level the tripod before adding the mount. When the tripod is assembled, lock the tray in place for added stability and easy accessory storage.

## Attaching The Equatorial Mount

After the tripod is set up, you are ready to attach the equatorial mount. This is the platform to which the telescope attaches and allows you to direct it anywhere in the sky. The mount is also adjustable so you can orient the axis of rotation to make it parallel with the Earth's axis of rotation (see the section on Physical Polar Alignment). To attach the equatorial mount to the tripod:

1. Insert the base of the equatorial mount into the top of the central column.
2. Tighten the knob to hold the equatorial mount in place.
3. Level the tripod with the equatorial mount installed using the bubble levels on the base of the equatorial head.

## Attaching The Counterweight Bar

To properly balance the telescope, the mount comes with a counterweight bar and counterweight. To install the counterweight bar:

1. Locate the opening in the equatorial mount on the DEC axis.  
It is opposite the telescope mounting platform.
2. Thread the counterweight bar into the opening until tight.  
Once the bar is securely in place you are ready to attach the counterweight(s).

## Attaching The Counterweight

The iEXOS 100 comes standard with two 1 kg counterweights.

To install the counterweight:

1. Orient the mount so that the counterweight bar points toward the ground.
2. Remove the counterweight safety thumbscrew and washer on the end of the counterweight bar (opposite the end that attaches to the mount).
3. Loosen the locking bolt on the side of the counterweight.
4. Slide the counterweight onto the shaft.
5. Tighten the locking bolt on the side of the weight to hold it in place.
6. Repeat this process if using a second optional counterweight (only if your telescope is larger and approaches the mount weight limit of 19 lbs [scope, accessories, and counterweights added together]).
7. Replace the counterweight safety thumbscrew and washer.

## Attaching The Telescope To The Mount

The telescope attaches to the mount via a dovetail bar bolted to the bottom of the telescope. Before you attach the optical tube, make sure that the declination and right ascension clutch knobs are tight. This will ensure that the mount does not move suddenly while attaching the telescope.

To mount the telescope tube:

1. Loosen the knob on the side of the telescope mounting platform.  
This allows you to slide the dovetail bracket of the telescope onto the mount.
2. Slide the dovetail bar of the telescope tube into the mounting platform of the mount.
3. Tighten the knob on the side of the mounting platform to hold the telescope in place.

## Moving The Telescope in R.A. and DEC

Once the telescope is set up, you will need to point it at various locations to observe different objects. To make rough adjustments, loosen the R.A. and DEC clutch knobs slightly and move the telescope in the desired direction. The R.A. clutch knob is near the Polar Axis Finder while the DEC clutch knob is at the top of the counterweight bar. How tight should the clutch knobs be? You set the clutch knobs to the friction you like. When you want to move the telescope, all you do is grab the telescope and move it to its new position. For fine adjustments, use the direction buttons on the ExploreStars app with the speed value set to a value of 1-5. (See ExploreStars app section of this manual.)

## Balancing The Telescope in R.A.

To eliminate undue stress on the mount, the telescope should be properly balanced around the polar axis. Proper balancing is crucial for accurate tracking. To balance the mount:

1. Verify that the telescope securing knob on the telescope mounting platform is tight.
2. Loosen the R.A. clutch knob and position the telescope off to one side of the mount.  
The counterweight bar will extend horizontally on the opposite side of the mount.
3. Release the telescope to see which way the telescope may drift as a result of an imbalance.
4. Loosen the locking bolt on the side of the counterweight so it can slide along the length of the counterweight bar.

5. Move the counterweight to a point where it balances the telescope. The telescope should remain stationary when the R.A clutch knob is loose.
6. Tighten the locking bolt on the counterweight to hold it in place.

While the above instructions describe a perfect balance arrangement, there should be slight imbalance to ensure the best possible tracking. When the scope is on the West side of the mount the counterweight should be slightly imbalanced to the counterweight bar side. And when the tube is on the East side of the mount there should be a slight imbalance toward the telescope side. This is done so that the worm gear is pushing against the slight load. **NOTE:** The amount of the imbalance is very slight.

When taking astro-photographs, this balance process can be done for the specific aim of the telescope to further optimize tracking accuracy.

## Balancing The Telescope in DEC

Although the telescope does not track in declination, the telescope should also be balanced in this axis to prevent any sudden motions when the DEC clutch knob is loose. To balance the telescope in DEC:

1. Loosen the R.A. clutch knob and rotate the telescope so that it is on one side of the mount (as described in the previous section on Balancing the Mount in R.A.).
2. Tighten the R.A. clutch knob to hold the telescope in place.
3. Loosen the DEC clutch knob and rotate the telescope until the tube is parallel to the ground.
4. Release the tube to see which way it rotates around the declination axis.  
**CAUTION: DO NOT LET GO OF THE TELESCOPE TUBE COMPLETELY!**
5. Slightly loosen the knob that holds the telescope to the mounting platform and slide the telescope either forward or backward until it remains stationary when the DEC clutch is loose.  
**CAUTION: DO NOT LET GO OF THE TELESCOPE TUBE WHILE THE KNOB ON THE MOUNTING PLATFORM IS LOOSE!**
6. Tighten the knob on the telescope mounting platform to hold the telescope in place.  
Like R.A. balance, these are general balance instructions and will reduce undue stress on the mount. When taking astro-photographs, this balance process should be done for the specific area at which the telescope is pointing.

## Troubleshooting

### Backlash in altitude knob.

The backlash on the altitude adjustment is  $1^\circ$  to  $1.5^\circ$ . Because of the tangent arm design this will cause no problems in the operation of the mount.

### Backlash in R.A. or DEC gear.

Backlash in the R.A or DEC gear is caused by two things. First, the meshing of the worm to worm gear and second, if there is play of the worm between the two worm bearing blocks. To take out the two causes of backlash, first remove the cover over the motor. Take out the two screws that hold the motor to the mount. Loosen and remove the two set screws located under the panel that covers the worm. Locate the worm bearing blocks and loosen the screw that is behind the bearing block that is furthest from the motor. Sandwich the two blocks between your fingers and pivot the worm into the worm gear slightly. Tighten the screw and try to rotate the worm in both directions. The worm should rotate freely. Grab hold of the DEC housing or the saddle plate depending on which axis you working on. Check to feel for any play. Repeat this operation until the backlash is removed, making sure there is no binding when rotating the worm through a complete rotation. If there is any binding the motors may not be able to move the mount properly.

**Clutches can not be tightened / Clutches skip then grab, when moving / Axes do not move freely.**

After years of use the clutch paddles and bearings need to be cleaned and lubricated. To do this, you must take apart the mount slightly. Both R.A. and DEC axes are the same. First, remove the clutch knob. Five parts will come off the shaft. Spring washer, aluminum spacer, thin washer, needle bearing and thin washer. Second, grab hold of the DEC housing or saddle plate depending on which axis you are working. Pull the axis straight out. At the end of the shaft you will find a nylon disc. Remove this piece and clean both sides with rubbing (isopropyl) alcohol. Clean the aluminum plate and shaft where the nylon disc rests. Clean the aluminum plate that is left on the mount. Look down the hole where the shaft fits you will see two needle bearings. One on top and one in the back of the mount. With your finger, see if you can turn the bearings easily. If not, apply WD-40 to the bearing and work them free. Once they can turn freely clean them with alcohol, then apply standard grease to the bearing. You will want to clean and grease the thrust bearing back by the clutch knob. Make sure not to get grease on the clutch area. Assemble the axis back together. Apply some grease on the threaded part of the shaft were the clutch knob screws.

**How tight do I need to make the clutches?**

Clutches are designed so that the operator does not have to loosen a knob to move the telescope. You find the setting that you like and leave it. The clutches will operate with just the slightest tension, though fully locked. You can not damage the motors or the drive by over tightening the clutches.

**How do the clutches work?**

When you tighten up the clutch knobs (one knob at the end of each axis) it pulls back on that axis. This pulls the pressure plate back against the surface of the gear. Between the pressure plate and the gear surface is a nylon disc. The more you tighten the clutch knob the harder it is to move the telescope. The tightness of the clutch does not have any effect on how hard the motors must work, but it does have an effect on the tracking of the mount. If the clutch is left loose, then the mount may slip and not track correctly. You need some pressure on the clutch for proper operation. A video tutorial also is available at [www.explorescientific.com/pmc-eight/](http://www.explorescientific.com/pmc-eight/).

**Additional Support**

If you have questions about setting up or operating the PMC-Eight system, a selection of video tutorials are available at [www.explorescientific.com/pmc-eight/](http://www.explorescientific.com/pmc-eight/)

For Frequently Asked Questions about the PMC-Eight, visit the Knowledge Base page at [www.explorescientific.com/knowledgebase](http://www.explorescientific.com/knowledgebase) and open the PMC-Eight Questions folder.

### Connecting The PMC-Eight System

Once the telescope is balanced, it is time to connect the PMC-Eight system.

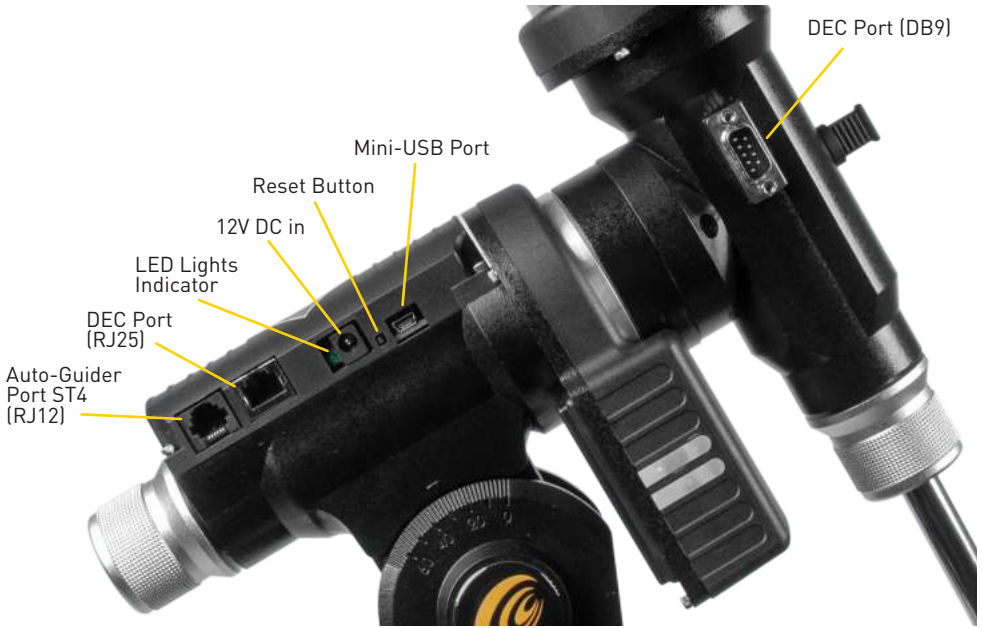

#### To Connect The PMC-Eight System:

1. Install 8 C batteries (**not included**) into the power supply pack and insert the pack into the mounting bracket on one leg of the tripod.
2. Connect the DB9 to RJ-25 DEC cable to the appropriate ports.
3. Plug the power cord from the pack into the 12V DC in port. Once connected, power would be on as indicated by the red led light next to the power connector.
4. When the PMC-Eight is on, go to the network settings on your device and connect to the mount's WiFi network — SSID: PMC-Eight-xxxx. The password will be "PMC-Eight".

**NOTE:** You will want to make sure you have installed your chosen operating software (ExploreStars app/ASCOM Driver) before connecting your device to the PMC-Eight "network." Once you are connected to PMC-Eight you will be unable to connect to other wireless sources, including your Internet connection.

**NOTE:** For wired ASCOM or Firmware upgrade, you will need a Serial/USB to Mini-USB cable (**not included**).

### Changing The WiFi Channel

In most instances, the pre-set WiFi channel should work perfectly well when operating the PMC-Eight wirelessly. However, if you are in an area where a lot of wireless activity is occurring, you may need to switch the pre-set WiFi channel.

#### To Change The WiFi Channel:

1. Power up the PMC-Eight and let it go through the boot process (the lights will settle out).
2. Insert the ST4 (RJ-12) WiFi Channel Switch Dongle into the auto-guider port.
3. Watch the green LED light cycle and the system should reboot itself
4. Remove the dongle
5. Press the Reset Button and wait until it settles down again, then try and connect the ExploreStars or ASCOM Client application again. To view what WiFi channel is being used, download WiFiInfoView from **[www.nirsoft.net](http://www.nirsoft.net)**.

### Wired Operation

Although it is designed to be operated wirelessly, the PMC-Eight can be attached directly to your Windows device. To do this, you will need a cable that has a Mini-USB Type B connector on one end and a Serial/USB Type A connector on the other end that is compatible to the port connections on your chosen device. This cable is not included with the PMC-Eight.

**NOTE:** The ASCOM driver supports Wired and Wireless Operation. The ExploreStars Application only supports Wireless Operation. You will have to use the ExploreStars PMC-Eight ASCOM Driver if you want to use the Mini-USB Port. Explore Scientific PMC-Eight® Application Note PMC8-AN003: Switching Between the WiFi Interface and the Serial Interface on the iEXOS 100 Mount Controller for more information.

You need to switch the default communications port to the desired configuration using the procedures in Application Note PMC8-AN003 listed above.

### Additional Support

If you have questions about setting up or operating the PMC-Eight system, a selection of video tutorials are available at **[www.explorescientific.com/pmc-eight/](http://www.explorescientific.com/pmc-eight/)**

For Frequently Asked Questions about the PMC-Eight, visit the Knowledge Base page at **[www.explorescientific.com/knowledgebase](http://www.explorescientific.com/knowledgebase)** and open the PMC-Eight Questions folder.

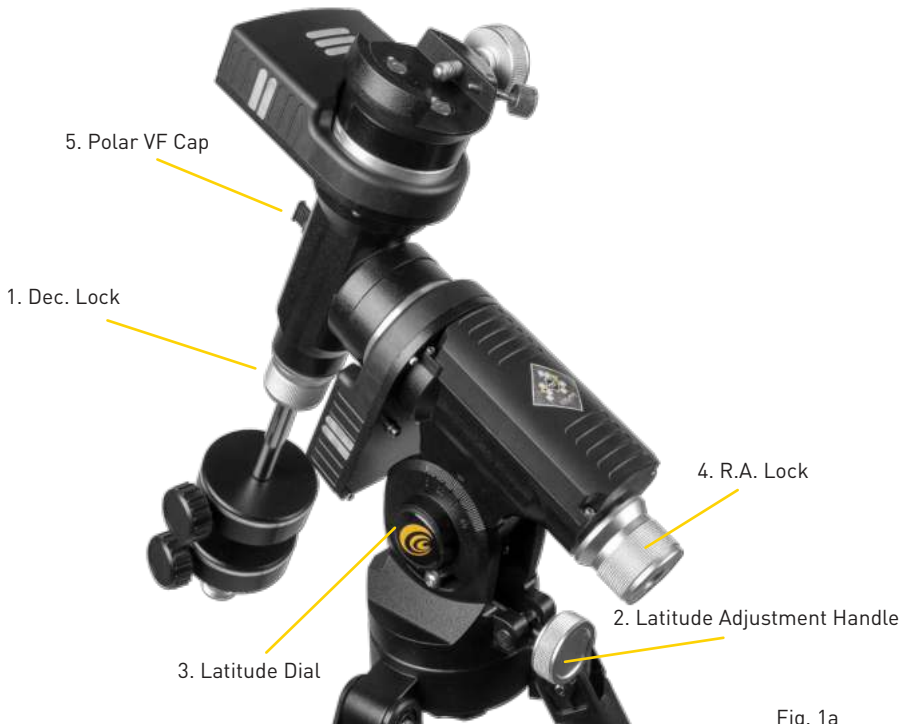

Fig. 1a

### Setting the Polar Home Position

NOTE: The following procedure will help you initially set up your mount to get it close to the proper alignment with the North Celestial Pole (NCP). You will then remove the Polar View Finder (VF) Cap and sight through the polar alignment tunnel in the RA axis, up through the RA lock.

- Level the mount by adjusting the length of the three tripod legs. Use the included bubble level to assist in this leveling.
- Unlock the R.A. Lock [4, Fig. 1a] Rotate the Optical Tube Assembly until the counterweight shaft is pointing straight down over the mount.
- If you have not already done so, lift the telescope assembly and turn it so that the tripod leg beneath the counterweight rod faces approximately North (South in the Southern Hemisphere). Release the Dec. lock [1, Fig. 1a] of the tripod, so that the optical tube may be rotated. Rotate the optical tube until it points North (or South in the Southern Hemisphere). Then re-tighten the lock. Locate Polaris, the North Star, if necessary, to use as an accurate reference for due North (or Octantis in the Southern Hemisphere).
- If you have not already done so, determine the latitude of your observing location. Visit the [LATITUDE AND LONGITUDE TOOL](http://explorescientific.com/latitude_longitude/) at [explorescientific.com/latitude\\_longitude/](http://explorescientific.com/latitude_longitude/) to find latitudes of any place on Earth. Once you have found your observing location, use the Latitude Adjustment Handle [2, Fig. 1a] to tilt the telescope mount so that the pointer indicates the correct latitude of your viewing location on the latitude dial [3, Fig. 1a].
- If steps 1 through 4 above were performed with reasonable accuracy, your telescope is now sufficiently well-aligned to Polaris, the North Star, for you to begin making observations. You can fine tune the alignment of your iXOS 100 mount by sighting through the polar alignment tunnel and make small adjustments to the Latitude Adjustment and the Azimuth adjustment on the mount. Once the mount has been placed in the polar home position as described above, the latitude angle need not be adjusted again, unless you move to a different geographical location (i.e., a different latitude) or if you are making a more precise polar alignment.



## Finding the Polar Star

Star hopping is a technique used by amateur astronomers to navigate the night sky. By using easily recognizable constellations and asterisms as a guide, an observer can locate stars and other objects. Polaris, which is commonly referred to as The North Star, can be located quickly using star hopping. Polaris is far from the brightest star in our night sky, but for centuries it has served as a navigational beacon representing true north because it lies extremely close to the north celestial pole. Although it has not always held this lofty position, Polaris' current reign has lasted for centuries and will continue for centuries to come.

### Follow these steps to locate Polaris using the star hopping method:

1. Locate the Big Dipper asterism in the Ursa Major constellation. The popular pattern is defined by seven stars. The two stars on the front edge of the Big Dipper's "bowl" are Merak and Dubhe.
2. Draw an imaginary line from the bottom star (Merak) on this front edge through the top star (Dubhe) on the front edge. Follow the line to the first bright star you see. That should be Polaris (Fig. 2a).
3. To verify your finding, locate the Little Dipper asterism. Polaris is the anchor star at the end of the Little Dipper's (in Ursa Minor) "handle."

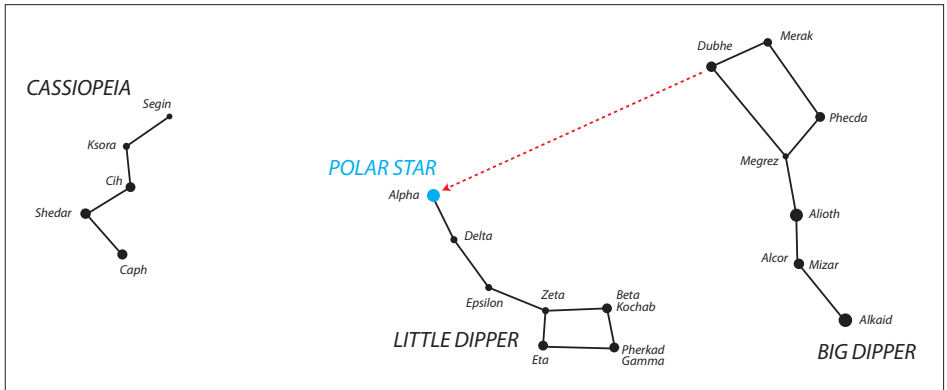

Fig. 2a

## Precision Polar Alignment - The Drift Method

Using this method, azimuth and altitude are adjusted separately until the effects of star drift are eliminated. This method is good for Northern and Southern Hemisphere users.

### • Azimuth adjustment

Select a star on the celestial equator and meridian [i.e., Hour Angle =  $0^\circ$  and Dec. =  $0^\circ$ ].

- If, over time, the star drifts S in the eyepiece then the southern end of the polar axis is pointing East of the Celestial Pole.
- If the star drifts N then the southern end of the polar axis is pointing West of the Celestial Pole.

### • Altitude adjustment

Select a star in the East (and/or in the West) low on the horizon and in the southern hemisphere of the Dec. =  $0^\circ$ .

- If the star in the East drifts N the elevation is too low.
- If the star drifts S the elevation is too high.

For more information on Polar Alignment on the Southern Hemisphere, visit Astronomical Society of South Australia website at [www.assa.org.au/resources/equipment-reviews/polar-alignment/](http://www.assa.org.au/resources/equipment-reviews/polar-alignment/)

## Using the Polar Alignment “Tunnel”

1. Use a compass to find north. Physically position the mount so that the front leg is aimed toward Polaris. Once this is done, level the mount.
2. Remove the cap covering the Polar Alignment Tunnel (**Fig. T1**). Loosen the Dec. clutch (**Fig. T2**) and rotate the telescope declination so that nothing is obstructing your view through the Polar Alignment Tunnel. (**Note that the telescope will be perpendicular to the polar axis during this exercise.**) Retighten the Dec. clutch.
3. While looking through the Polar Alignment Tunnel towards the sky, loosen the mount head tripod attachment knob (**Fig. T3**) slowly move the mount in azimuth and the latitude adjustment knob (**Fig. T4**). To fine tune the alignment in the Northern Hemisphere, center Polaris in the Polar Alignment Tunnel. This can be a long process, and you may have to adjust the right ascension again. If you can view Polaris through the tunnel then this is close enough (**Fig T5**). To fine tune the alignment in the Southern Hemisphere, center the South Celestial Pole in the Polar Alignment Tunnel. If you can see Sigma Octans on the outer edge of the tunnel then this is close enough (**Fig T6**).
4. Once you are satisfied with your alignment, loosen the Dec. clutch and rotate the telescope to 90° North so that it is once again facing in the same direction as the Polar Alignment Tunnel. Tighten the mount head tripod attachment knob (**Fig. T3**) after you have the final adjustment. Replace the cap covering the Polar Alignment Tunnel.

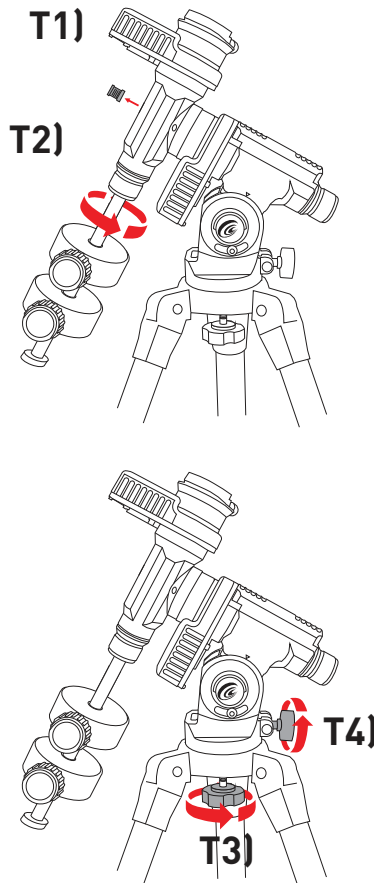

## Northern Hemisphere Users

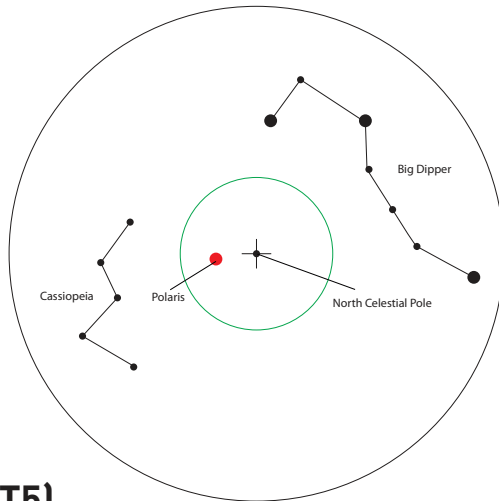

T5)

*NOTE: Constellation depiction is not to the same scale as the "tunnel". The southern hemisphere DOES show the constellation of Octans to the same scale as the tunnel.*

 = 2.5° FOV on  
iEXOS 100 Mount "Tunnel"

## Southern Hemisphere Users

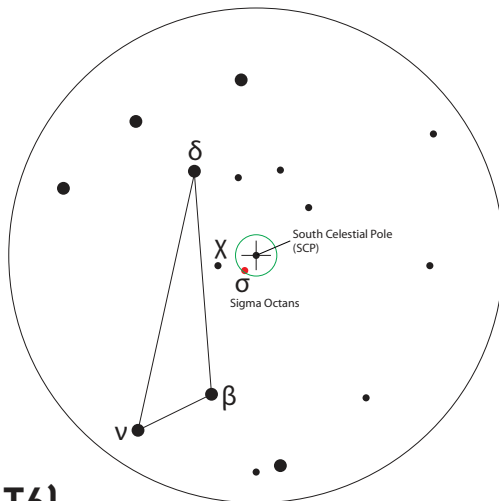

T6)

## Welcome to ExploreStars!

Designed specifically for the PMC-Eight, the intuitive ExploreStars app will streamline your observing experience by making it easy to align your equipment, navigate the stars and learn specifics about tens of thousands of celestial objects. It also leaves room for manual operation.

### Installing The ExploreStars APP

The free ExploreStars application can be downloaded from the Windows app store onto your Windows device. Once you install ExploreStars, you will need to download the object database that provides the content for the application. To do this, go to [www.explorestars.com](http://www.explorestars.com) and follow the instructions on the website to download the extensive object database.

### Operating The ExploreStars APP

When you first open ExploreStars, you will need to make sure your location (latitude and longitude), date/time and other vital information are correct.

1. Go to the menu in the upper left corner of the screen, open Settings and select Preferences. If the latitude and longitude coordinates or the date/time for your current location are not correct, update the information in the appropriate boxes.
2. You will then need to select your mount — iEXOS 100 — in order to ensure that the step counts for both Right Ascension and Declination are correct.

Once these preferences are set, exit to the home screen. On the right, you will see the manual control buttons that are used to select speed and motion direction. The top menu bar will have your object catalogs. The bottom menu bar will have alignment options.

### Alignment

After confirming your preferences, you will need to perform an alignment to ensure that the telescope, the PMC-Eight system and the sky are in sync. The ExploreStars application has three options for aligning your system — **2 Star Alignment**, **3 Star Alignment** and **Alignment Tour**. To start the alignment process, press or click on the “Reset Alignment” button in the lower right corner of the home screen and then select your preferred alignment option from the list in the bottom left.

**NOTE:** The 2 and 3 Star Alignment process provides a “virtual” polar alignment versus doing a “physical” polar alignment. It is important to understand the difference.

#### To Perform A 2 Star Alignment:

**NOTE:** For best alignment results, you should use a medium power (12-18 mm) cross-hair eyepiece when centering the target star.

1. Select the 2 Star Alignment option from the bottom menu bar. The app will pull up a suggested target that should be the first visible alignment star closest to the western horizon. If this star is not visible, select “Try Next Star,” and the program will bring up another choice.
2. Once it pulls up a star that is visible from your location, select “Align to this Star.” This will bring up the alignment screen.
3. At this point, you will need to center the target star in your eyepiece. Using the direction buttons on the right side of the screen, you can move the telescope up, down, left and right. The numbers are used to determine motor speed with 0 being the slowest and 9 being the fastest. During this centering process, you should probably make bigger adjustments using a speed in the 3 to 5 range and then fine tune using the 1 or 2 speeds. The higher speeds (6-9) are for larger movements, so they will not be useful during this part of the alignment process.
4. Once you have centered the selected star in the eyepiece, press or click on the “Sync” button which is located under the number 7.
5. After you have synced to this star, the display will show you the next available star and you can begin the same process with the second star. Based on your first selection, the program will select the next star beginning on the eastern horizon. If this selection is not visible, select “Try Next Star” until you arrive at a target that will work.

**NOTE:** The 3 Star Alignment and Alignment Tour Options Follow The Same Process Only With An Extra Star To Align To.

### Point Mode and Track Mode

There is an advanced feature in the ExploreStars application that ensures accurate tracking rates are maintained when a proper physical polar alignment is not obtained and you are performing the 2 or 3 Star Virtual Alignment procedure. There are two tracking modes available called Track mode and Point mode.

When slewing to an object after a 2 or 3 Star Alignment, the system goes into Point mode, which directs the mount to continually "Point" to the object based on the real-time calculated motor position using the 2 or 3 star pointing correction.

The behavior of the mount in this mode is such that the tracking rate not only on the RA axis but also the DEC axis is adjusted dynamically and is updated five times per second to maintain the object in the center of the field.

When slewing the mount manually with the keypad buttons, the system reverts to "Track" mode, which sets the RA axis rate to the predetermined set tracking rate value. All of these functions result in excellent object tracking for both visual observing and astrophotography.

The Point mode is indicated on the ExploreStars display as a "triangle P" symbol, and the Track mode is indicated by the "square Tr" symbol. So even if you are not physically polar aligned, you can still rely on the tracking rates to be accurate when doing astrophotography. There are limitations to the length of exposure with regard to field rotation based on the focal length and image scale of your equipment.



Point Mode



Track Mode

**CAUTION:** When using the AUTO-GUIDING (ST4 RJ-12) port with the ExploreStars application, the controller SHOULD BE PLACED IN "TRACK MODE". When AUTO-GUIDING in "POINT MODE" the tracking performance of the mount will degrade, and result in a small amount of NON-PERIODIC ERROR.

### Finding Objects

The ExploreStars app makes it easy to navigate the night sky by organizing its massive database of celestial objects into catalogs — Messier Objects, Solar System Objects and Alignment Stars.

To find celestial objects from the provided catalogs:

1. Select one of the categories on the top menu bar, and you will be presented with a variety of targets.
2. Choose an object, and the application will pull up an image of the object and detailed information about it.
3. If the object is currently above the horizon at your location, a "Slew to Object" button will appear beneath the image.

**NOTE:** If the object is not above the horizon in your area, this "Slew to Object" button will not appear.

When you press the "Slew to Object" button, the mount slews to the target and the home screen display will appear with a map showing a blinking red dot representing the location of the chosen object. Buttons below this location display allow you to move to either the previous object or the next object in this particular series with a simple push of a button.

**You Can Also Choose The Take A Tour Option To Explore The Night Sky. To Do This:**

1. Select “Take Tour,” and you will be presented with a list of constellations to tour.
2. Once you select one, the display will show the sky map of the object closest to the western horizon that is visible in the constellation.
3. To move the telescope to the object, select “Go To Target.” If you would like more details about this object, select “Target Info” in the bottom right corner. To exit the tour, simply press App Bar.

**Coordinate Input:**

To move to specific coordinates, select “Coordinate Input” from the bottom menu options. This will bring you to the coordinate entry screen where you can enter either RA/DEC or ALT/AZ information in either decimal or hms format. Once you submit your information, the destination of the telescope will be displayed on the screen as it slews.

**Load Extra Stars:**

To access extra libraries of celestial objects, select the “Load Extra Stars” option. To access objects in these libraries, do a keyword search for an object using the built-in Windows search feature. Once a list of objects related to your search pops up, you can select one and it will take you to the target’s information page. If the object is above the horizon, the “Slew to Object” button will appear on that page.

**Manual Operation**

The telescope can be moved using the control pad on the right side of the application’s home screen. The numbers represent the speed at which the mount will move with 0 being the slowest and 9 being the fastest. In general, each speed is twice as fast as the previous one. Once you select a speed, use the up, down, left, right navigation buttons to move the telescope to your desired position. You can also control the mount using the “compass” image on the left side of the home screen. Press the Explore Scientific logo in the center of the compass and drag it in the direction that you would like the telescope to move, this acts like a virtual joystick controller. As you move the dot, a number will appear in the middle that shows the speed at which you are moving the mount. The further from the original location that you move the dot, the faster the scope will travel in that direction.

**Other Features:**

**Park the mount:** This option will send the mount back to its original position pointing at the north celestial pole (NCP) or very close to the star Polaris.

**Reset Alignment:** Anytime you relocate the telescope/mount, you will want to go through the alignment process again. This option clears the current alignment settings.

**Emergency Stop:** If you ever need to stop the mount in a hurry, then you can touch any of the direction buttons or the compass rose virtual joystick area. The mount should immediately stop slewing at that point.

**Sync on Target:** If you find the target is not well centered in the eyepiece after executing a go-to command (due to misalignments, poor leveling, improper time output or errors in site location), center the object. Then press the Sync on Target button. This feature in essence synchronizes the telescope to a particular area of the sky. The next object will be better centered provided it is not too far away from the target you synced on.

## ASCOM Driver Installation for the PMC-Eight™ System

Although Explore Scientific has developed its own app — ExploreStars — to operate the PMC-Eight, we recognize that the astronomy community is a diverse one. That is why we also offer the PMC-Eight ASCOM driver so users may employ the ASCOM-powered planetarium software of their choosing to run the PMC-Eight either wirelessly or through a wired connection.

With this driver, the PMC-Eight is compatible with a wide range of guidance software programs built around the industry standard ASCOM interface – including the American Astronomical Society's WorldWide Telescope. This massive virtual observatory is an outstanding free resource used by professional and amateur astronomers, and planetarium directors alike, because of the high-quality data and real images obtained by some of the world's most advanced telescopes. These images are the same that professionals use in their research. While the program allows PC control of the PMC-Eight with our ASCOM driver, it also has tools to create amazing multimedia full-motion tours with audio and visualizations that have allowed professional astronomers to further their research.

Originally developed by Microsoft Research, WWT is hosted by the American Astronomical Society (AAS). The program and data were developed with a philosophy of continual improvement. Explore Scientific and the AAS teamed up in 2016 to launch the WWT Prize Competition for best new tours with First Place Winner Beau Hartweg for his tour 'Eclipse: Countdown to Totality'.

WWT is one of the ultimate planetarium and telescope control platforms available today. This feature rich application is used by millions of amateur and professional astronomers and planetarium educators around the world, and is available from the AAS for free. Visit [worldwidetelescope.org](http://worldwidetelescope.org)

Some of the other popular ASCOM software packages available for use with the PMC-Eight are: ACP; APT; AST / ATC & Ricerca (Omega Lab); AstroArt; AstroMB; Cartes du Ciel / Sky Chart; CCD AutoPilot; DeepSky; Deepsky Planner; DFM Engineering; Earth Centered Universe Pro; EasySky; Eye and Telescope; Project Pluto; Hallo Northern Sky; Maxim DL; MaxPoint; PinPoint Astrometric; Prism; Sequence Generator Pro; Sidereal Technology; The Sky; SkyMap Software; SkyTools 3; Star Atlas PRO; Sky Observer; StarryNight; Stellarium; and Virtual Moon Atlas.

**NOTE:** These packages are copyright each of their respective copyright owners. Search the Internet to find the installation setup programs for these applications and programs.

This manual will guide you through installing the ASCOM driver, which can be found at [www.explorescientific.com/pmc-eight/](http://www.explorescientific.com/pmc-eight/)

### Installing The ASCOM Driver

To install the ASCOM driver for the PMC-Eight, please follow this procedure:

1. Go to the ASCOM standards website ([www.ASCOM-Standards.org](http://www.ASCOM-Standards.org)) and download the latest ASCOM platform using the download link provided at the upper right hand corner of the page.
2. Run the platform setup program, and follow the instructions in the program.
3. After the completion of the platform installation, locate the icon on your desktop or in your programs list for the ASCOM Diagnostics and start the program.

**NOTE:** The following step will run for a few minutes and test all the platform drivers and programs to ensure the proper operation of the platform.

4. Press the Run Diagnostics button to verify that the platform has been installed correctly.
5. On completion of the test, verify that there are zero fails.

**NOTE:** Steps 6, 7, and 8 direct you to use the ASCOM-Standards.org website to get to the Explore Scientific PMC-Eight ASCOM Driver download. You can also download the Explore Scientific PMC-Eight ASCOM Driver by going directly to the webpage at: <http://explorescientific.com/pmc-eight>.

6. On the ASCOM-Standards.org website, using the menu on the upper left corner of the page, navigate to the Downloads page.
7. Using the menu on the upper left corner of the page, select Telescope/Mount Driver Downloads
8. Scroll down the Telescope/Mount Driver page and locate the Explore Scientific PMC-Eight Section. Press the Visit Site button to go to the Explore Scientific PMC-Eight webpage.
9. On the PMC-Eight ASCOM Driver webpage, hit the ASCOM driver download link and download the setup program.
10. Run the PMC-Eight ASCOM Driver setup program, and follow the directions in the program.

**NOTE:** If you have previously installed the PMC-Eight ASCOM driver and wish to install it again, or install an updated driver, run it again and the installation should overwrite the current driver. Sometimes depending on your particular configuration, it will not work the first time. In this case, you need to manually uninstall the current driver before installing the latest one. You can do this under Settings/Apps and Features.

11. After installing the PMC-Eight ASCOM Driver, restart your computer system.
12. Connect your mount's motors to the PMC-Eight System and power up the PMC-Eight controller.

**NOTE:** If you desire to test your PMC-Eight System using the ASCOM driver, then perform steps 13-30.

13. After your system restarts, bring up your network settings and find the PMC-Eight SSID, i.e., "PMC-EIGHT-XXXX" where XXXX is a four character alpha-numeric such as "3F28"

**NOTE:** Your device may ask for a network password when connecting to the PMC-Eight SSID. The default password is "PMC-Eight".

14. Connect to the PMC-Eight network. Note that the connection will show SECURE, LIMITED since it is a local AD HOC network connection to the PMC-Eight controller.
15. Locate the icon on your desktop or in your programs list for the ASCOM Diagnostics and start the program.
16. On the diagnostic programs' top menu find "Choose Device" and "Choose and Connect to Device".
17. This will bring up the programs window. Find and push the "Choose" button.

18. The ASCOM Chooser window will display. Find and select "ES\_PMC8.Telescope" in the drop-down list. (Figure 1.)

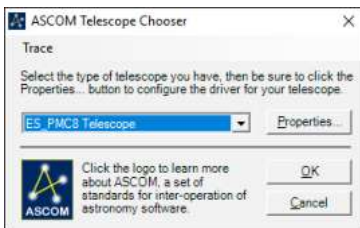

Figure 1. ASCOM Telescope Chooser window.

19. Push the "Properties" button and display the PMC-Eight ASCOM Driver Configuration window. (Figure 2.)

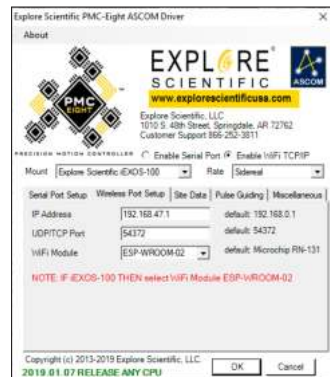

Figure 2. Explore Scientific PMC-Eight™ ASCOM configuration window.



20. Select the iEXOS 100 mount in the drop-down list.
21. In the ASCOM Driver dialog box, select Enable WiFi TCP/IP for wireless ASCOM or Enable Serial Port for hardwired ASCOM.
22. Ensure you select the WiFi Module "ESP-WROOM-02" for the iEXOS 100 as per the note.
23. Update the "Site Data" for your location.
24. Press the OK button when done.
25. Hit OK on the ASCOM Telescope Chooser window.
26. On the "Device Connection Tester" window, press the "Connect" button and see that the program connects to the PMC-Eight.
27. On the "Device Connection Tester" window, press the "Get Profile" button and see that the program displays the various ASCOM parameters from the PMC-Eight.
28. You should see something similar to the following:

<i>Create</i>	<i>Creating device</i>
<i>Connected</i>	<i>Connecting to device</i>
<i>Name</i>	<i>Explore Scientific PMC-Eight ASCOM Driver</i>
<i>Description</i>	<i>ES_PMC8 Telescope</i>
<i>DriverInfo</i>	<i>Explore Scientific PMC-Eight Mount Controller ASCOM Driver.</i>
<i>Developed by</i>	<i>GRHubbell. Contact Explore Scientific at <a href="http://www.explorescientificusa.com">www.explorescientificusa.com</a> . Version: 6.0</i>
<i>DriverVersion</i>	<i>6.0</i>
<i>InterfaceVersion</i>	<i>3</i>
<i>RA, Dec</i>	<i>22:13:05.927 90:00:00.000</i>
<i>Latitude, Longitude</i>	<i>36:10:50.268 -94:11:18.168</i>
<i>Tracking</i>	<i>False</i>
<i>Connected</i>	<i>Disconnecting from device</i>
<i>Dispose</i>	<i>Disposing of device</i>
<i>Dispose</i>	<i>Completed disposal</i>
<i>ReleaseComObject</i>	<i>Releasing COM instance</i>
<i>GC Collect</i>	<i>Starting garbage collection</i>
<i>GC Collect</i>	<i>Completed garbage collection</i>

29. Close the "Device Connection Tester" window
30. Exit the ASCOM Diagnostics program.
31. Reset your network settings to your normal SSID if you are not going to use the PMC-Eight any further, otherwise, start up your ASCOM planetarium client or other type of ASCOM client and connect to the PMC-Eight using the ASCOM chooser available in that client.

### **Additional Support**

If you have questions about installing the ASCOM driver for the PMC-Eight, please do not hesitate to contact our Customer Service Center with your questions or suggestions through an online chat at [www.explorescientificusa.com](http://www.explorescientificusa.com) or by calling (866) 252-3811. A video tutorial also is available at [www.explorescientific.com/pmc-eight/](http://www.explorescientific.com/pmc-eight/)

For Frequently Asked Questions about the PMC-Eight, visit the Knowledge Base page at [www.explorescientific.com/knowledgebase](http://www.explorescientific.com/knowledgebase) and open the PMC-Eight Questions folder.

## Join the OpenGOTO community!

One of the most revolutionary aspects of the PMC-Eight OpenGOTO system is undoubtedly its open source software. With our precision motion control system, you can create a unique observing experience and find your own inspiration in motion.

The PMC-Eight was specifically designed to allow you to create your own vision about how to use the system. We put an emphasis on accessibility so you can unleash the full potential of this extraordinary system. The result is complete access to the coding that drives the PMC-Eight OpenGOTO.

The software developer's kit provides you the building blocks you need to discover new ways to customize our powerful system to better serve your individual needs. Programmers can use their unique skills to manipulate the PMC-Eight's robust electronics, which include a two motor channel multi-processor micro-controller with eight central processing units that operate independently of one another. Additional features include a 64 Kbyte EEPROM non-volatile Memory bank used to store parameters; a wireless Ethernet 10/100 with full IP function that permits operation from anywhere using a browser, ASCOM or application over the web or serial port; and non-volatile memory used to store various parameters. The electronics also includes an auto-guider port (ST4 contact input).

At [www.explorescientific.com/pmc-eight/](http://www.explorescientific.com/pmc-eight/) innovative thinkers interested in customizing the PMC-Eight can find the SDK and access the OpenGOTO community where they can interact with other programmers through the PMC-Eight Group forum located at <https://groups.io/g/ESPMC-Eight>

We encourage you to make this system your own, and we cannot wait to experience the results of your efforts!

## Share the Sky!

Awakening individuals to the marvels of the universe can be one of the most rewarding aspects of owning a telescope.

When you share your eyepiece with others, you can witness their sense of wonder bloom as they take in celestial spectacles like the chiseled lunar terrain, the elegant rings of Saturn or the blue-white stars of the misty Orion Nebula for the first time.

Whether you are in your backyard, on a street corner or at star party, by using your telescope for outreach you are continuing a tradition started by Galileo more than 400 years ago. Since then, humanity's understanding of the universe has grown at an astounding pace, and much of that discovery can be linked to the desire to explore that is born from looking through a telescope. Founded in 2000, the Astronomy Outreach network (AOn) was created to encourage and celebrate public outreach efforts by astronomers of all levels. This non-profit organization has tasked itself with forging connections between individual astronomers, astronomy clubs and larger astronomy and space education initiatives. No matter where you are at in your journey to provide outreach, AOn is a great resource that can be accessed at [www.astronomyoutreach.net](http://www.astronomyoutreach.net) or through Facebook and Twitter.

As Carl Sagan said, "The Earth is a very small stage in a vast cosmic arena." At the eyepiece, the petty differences of humanity dissolve as our collective place in the universe is put in perspective. We are on this "pale blue dot" together, and helping others realize our common fragile bond is vital.

We encourage you to help others access the stars while you are on your own journey of exploration. The mind-expanding experience you can share can truly make a difference by inspiring others to discover more about the planet, the solar system, the galaxy and the universe we all call home.

Visit [www.astronomyoutreach.net](http://www.astronomyoutreach.net) today!

## Proper Care

The iEXOS 100 is a precision system and keeping all parts free of dust and dirt is crucial for optimal performance.

After each use, wipe all parts of the mount down with a clean cloth. DO NOT expose the motor system or any parts to water or other liquids.

## WARNINGS

Read and follow the instructions, safety rules, and first aid information.



**SUN WARNING:** Never attempt to observe the Sun with this device! Observing the Sun – even for a moment – will cause instant and irreversible damage to your eye or even blindness. Eye damage is often painless, so there is no warning to the observer that the damage has occurred until it is too late. Do not point the device at or near the Sun. Do not look through the device as it is moving. Children should always have adult supervision while observing.

**RESPECT PRIVACY:** When using this device, respect the privacy of other people. For example, do not use this device to look into people's homes.

**CHOKING HAZARD:** Keep packaging materials like plastic bags and rubber bands out of the reach of children as these materials pose a choking hazard.

**RISK OF BLINDNESS:** NEVER use this device to look directly at the Sun or in the direct proximity of the Sun. Doing so may result in a permanent loss of vision.

**RISK OF FIRE:** Do not place device, particularly the lenses, in direct sunlight. The concentration of light rays could cause a fire.

– Do not subject the device to temperatures exceeding 60 °C (140 °F).



**DISPOSAL:** Keep packaging materials, like plastic bags and rubber bands, away from children as they pose a risk of suffocation. Dispose of packaging materials as legally required. Consult the local authority on the matter if necessary and recycle materials when possible.



– The WEEE symbol if present indicates that this item contains electrical or electronic components which must be collected and disposed of separately.

– Never dispose of electrical or electronic waste in general municipal waste. Collect and dispose of such waste separately.

– Make use of the return and collection systems available to you, or your local recycling program. Contact your local authority or place of purchase to find out what schemes are available.

– Electrical and electronic equipment contains hazardous substance which, when disposed of incorrectly, may leak into the ground. This can contribute to soil and water pollution which is hazardous to human health, and endanger wildlife.

– It is essential that consumers look to re-use or recycle electrical or electronic waste to avoid it going to landfill sites or incineration without treatment.

**BATTERY WARNING:**

– Battery guidelines: This device contains electronic components that are powered by batteries. Batteries should be kept out of children’s reach. When inserting batteries, please ensure the polarity is correct. Insert the batteries according to the displayed +/- information. Never mix old and new batteries. Replace all batteries at the same time. Never mix alkaline, standard carbon-zinc and rechargeable nickel-cadmium batteries. Never short circuit the device or batteries or throw either into a fire. Leaking or damaged batteries can cause injury if they come into contact with the skin. If you need to handle such batteries, please wear suitable safety gloves. Remove batteries from the product before extended storage to prevent leaking. Do not immerse the battery compartment in water. Non-rechargeable batteries are not to be recharged. Rechargeable batteries are to be removed from the device before being charged. Rechargeable batteries are only to be charged under adult supervision. Exhausted batteries are to be removed from device. The supply terminals are not to be short-circuited. Please recycle batteries responsibly.



This device complies with Part 15 of the FCC Rules. Operation is subject to the following two conditions: (1) this device may not cause harmful interference, and (2) this device must accept any interference received, including interference that may cause undesired operation.

NOTE: This equipment has been tested and found to comply with the limits for a Class B digital device, pursuant to part 15 of the FCC Rules. These limits are designed to provide reasonable protection against harmful interference in a residential installation. This equipment generates, uses and can radiate radio frequency energy and, if not installed and used in accordance with the instructions, may cause harmful interference to radio communications. However, there is no guarantee that interference will not occur in a particular installation. If this equipment does cause harmful interference to radio or television reception, which can be determined by turning the equipment off and on, the user is encouraged to try to correct the interference by one or more of the following measures:  
 —Reorient or relocate the receiving antenna.  
 —Increase the separation between the equipment and receiver.  
 —Connect the equipment into an outlet on a circuit different from that to which the receiver is connected.  
 —Consult the dealer or an experienced radio/TV technician for help.

This Class B digital apparatus complies with Canadian ICES-003.  
 Cet appareil numérique de la classe B est conforme à la norme NMB-003 du Canada.

This device complies with Industry Canada licence-exempt RSS standard(s). Operation is subject to the following two conditions: (1) this device may not cause interference, and (2) this device must accept any interference, including interference that may cause undesired operation of the device.

Le présent appareil est conforme aux CNR d’Industrie Canada applicables aux appareils radio exempts de licence. L’exploitation est autorisée aux deux conditions suivantes : (1) l’appareil ne doit pas produire de brouillage, et (2) l’utilisateur de l’appareil doit accepter tout brouillage radioélectrique subi, même si le brouillage est susceptible d’en compromettre le fonctionnement.

This device complies with RSS-247 of industry Canada , Operation is subject to the condition that this device does not cause harmful interference.

Le présent appareil est conforme aux CNR-247 d’Industrie Canada applicables aux appareils radio. l’appareil ne doit pas produire de brouillage.





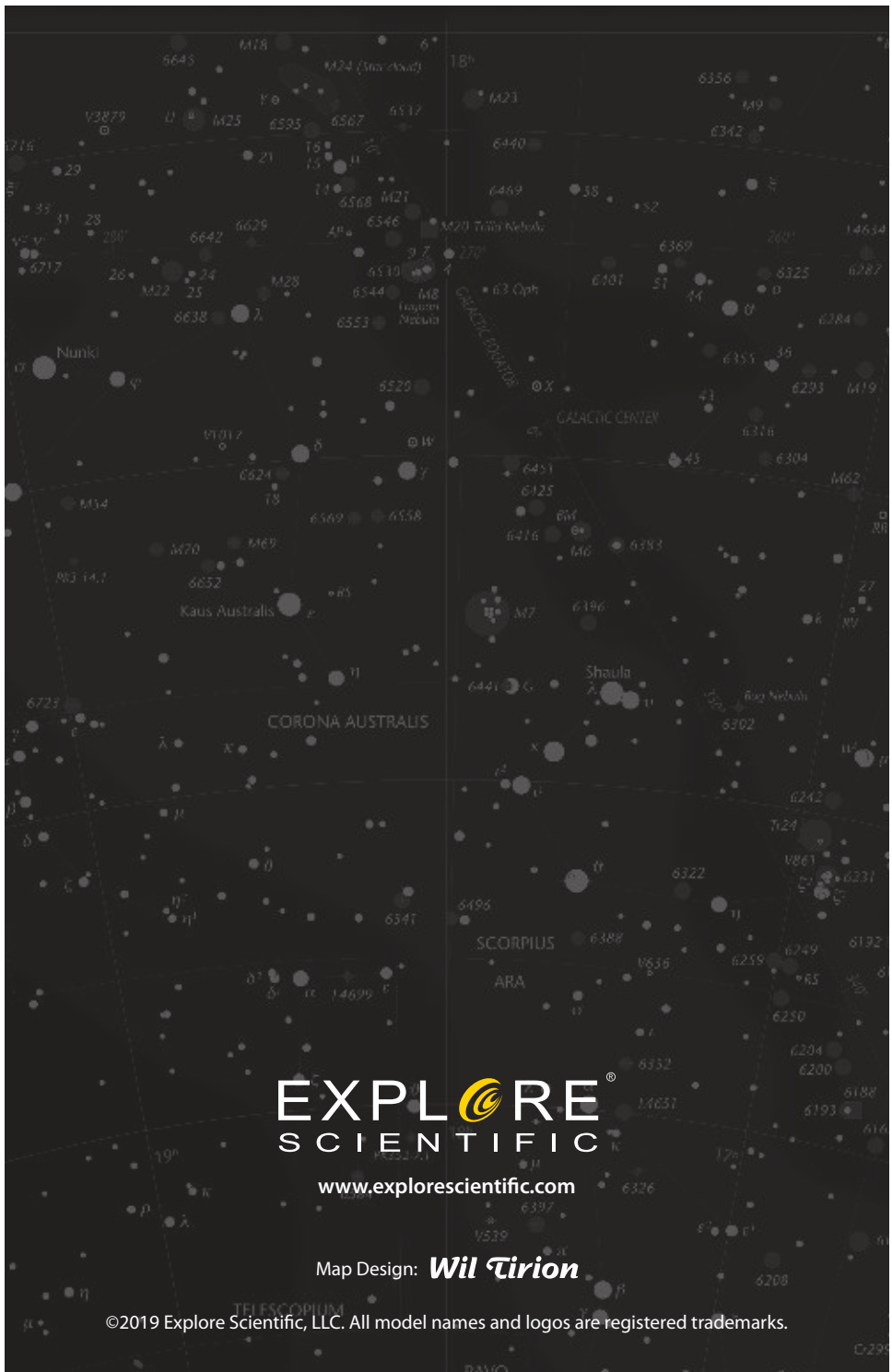

# EXPLORE<sup>®</sup> SCIENTIFIC

[www.explorescientific.com](http://www.explorescientific.com)

Map Design: *Wil Tirion*

©2019 Explore Scientific, LLC. All model names and logos are registered trademarks.