

# CARSON<sup>®</sup>

## HookUpz™ 2.0

IS-200



### Smartphone Optic Adapter

Congratulations on selecting your new HookUpz Smartphone Optic Adapter! In order to achieve optimum performance, please follow instructions for proper use and care.

#### SMARTPHONE OPTIC ADAPTER DIAGRAM

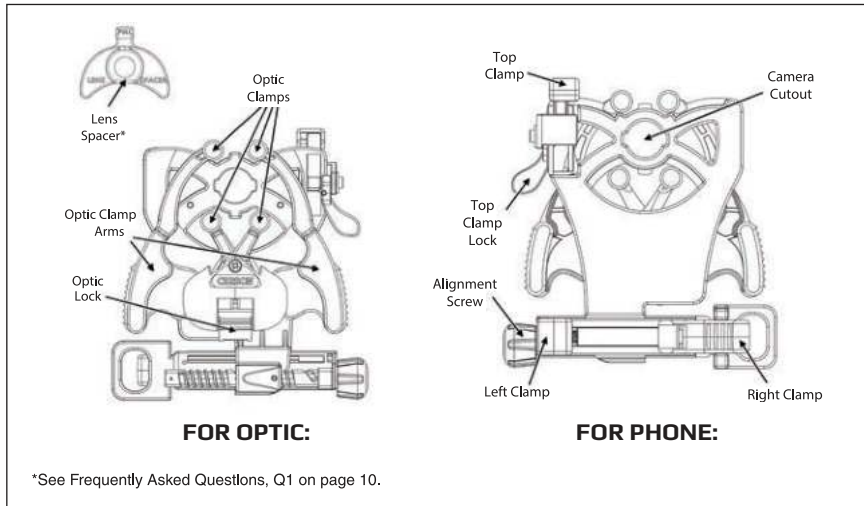

#### PRODUCT SPECIFICATION:

Weight:	0.3 lbs
Dimensions:	4.3" x 2.3" x 4.5"

#### INSERTING PHONE:

1. Rotate to unlock top clamp.

Fig. 1

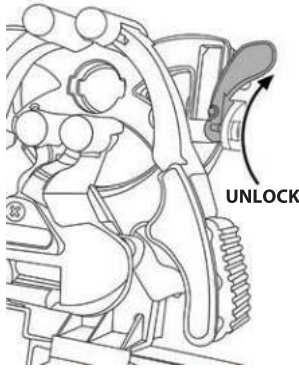

2. Slide top clamp into uppermost position.

Fig. 2

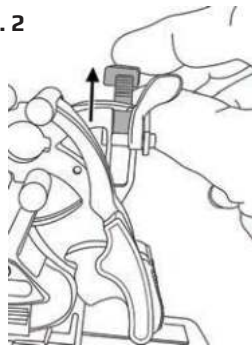

3. Insert phone into left clamp.

Fig. 3

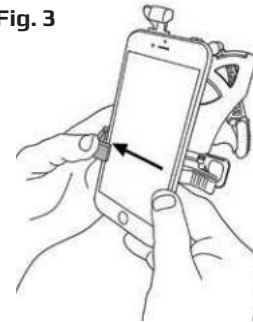

4. Squeeze and pull right clamp past edge of phone.

Fig. 4



5. Release right clamp to secure phone.

Fig. 5

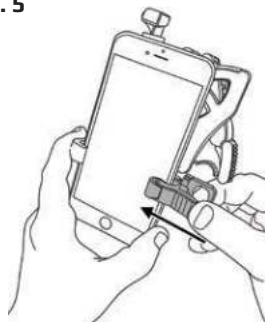

6. Ensure phone is flat as possible to adapter.

Fig. 6

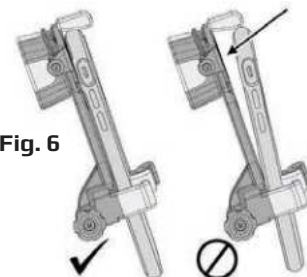

**ALIGN AND LOCK:**

1. Slide phone vertically until camera cutout is over the primary camera.\*

**Fig. 7**

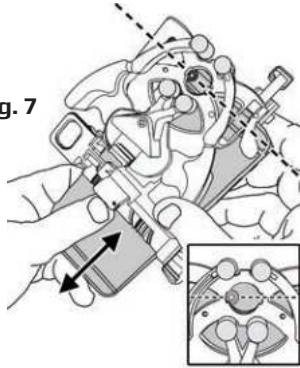

**\*Multiple-Lens Camera Phones:**

If there is more than one rear facing camera, use the primary one. Typically, the primary is a 1x wide-angle color camera and the others are secondary.

For iPhone 13 Pro / Pro Max, please download CarsonCam app (requires at least IOS 15.4) to preselect the primary camera, as it may not function properly with the standard camera app.

For the latest instructions on multiple camera phones, please visit: [www.carson.com/multicam](http://www.carson.com/multicam)

2. Turn alignment screw until camera is centered in camera cutout.

**Fig. 8**

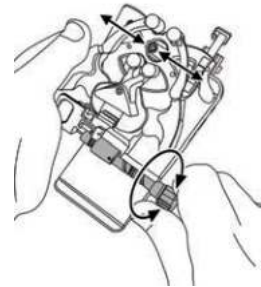

3. Slide top clamp down against phone edge. If top clamp does not fit, refer to Q3 in the FAQs section.

**Fig. 9**



4. While holding top clamp tight to phone, rotate to lock.

**Fig. 10**

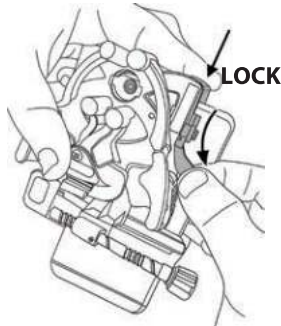

5. Figure 11 shows a properly aligned camera. If needed, use alignment screw and top clamp to make further adjustments.

**Fig. 11**



**BEFORE ATTACHING TO OPTIC:**

Make sure optic is focused. If your optic has flexible eyecups, fold down and attach optic.

**Fig. 12**

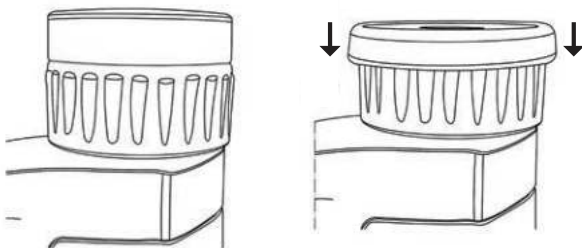

## ATTACHING TO OPTIC:

1. Squeeze arms to open optic clamp.

Fig. 13

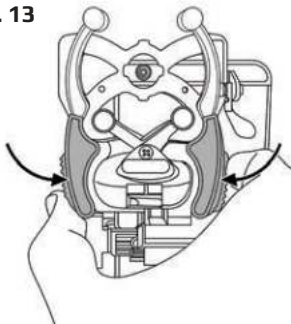

2. Do not squeeze arms while reaching around phone, otherwise phone alignment may be altered.

Fig. 14

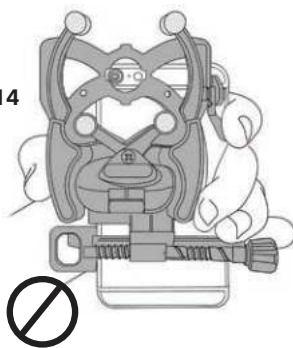

3. Once opened, place over eyepiece and release.

Fig. 15

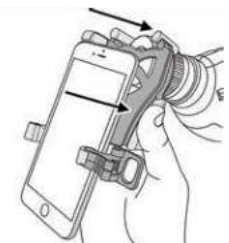
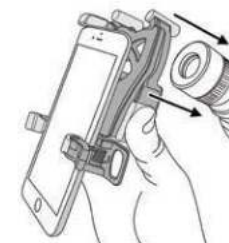

4. Phone can be positioned in either portrait or landscape.

Fig. 16

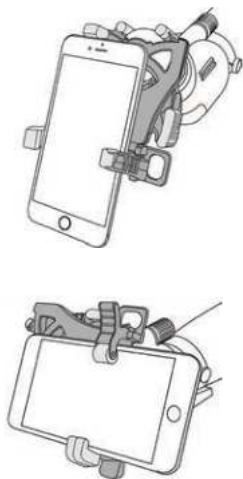

5. Ensure adapter is flush to the eyepiece of your optic.

Fig. 17

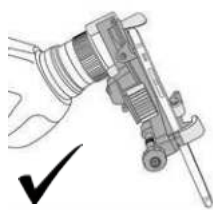

6. For smaller eyepieces, push optic lock down while attached to eyepiece.

Note: This is not needed for larger eyepieces.

Phone. 18

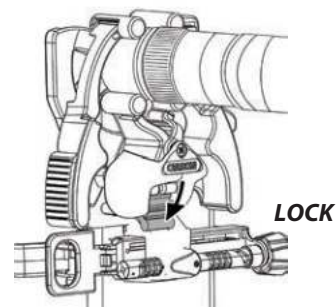

7. Turn on camera. If image is not centered, repeat alignment steps.

Fig. 19



8. To maximize your image, pinch to enlarge image. For best results, use in video mode.

Fig. 20



### TO REMOVE OPTIC FROM ADAPTER:

Press optic clamp arms together to open adapter and remove from optic. To minimize an audible click noise, or if the optic lock does not release automatically, rotate it upwards to unlock.

### TO REMOVE PHONE FROM ADAPTER:

To save your alignment, make no further adjustments to the top clamp and alignment knob. Simply remove phone using right clamp only as shown in Fig. 4.

### USING ADAPTER AGAIN:

The alignment of your phone to the adapter should be saved from the initial setup, so many steps can be skipped (Fig. 1-2, 7-10) and only a quick fine adjustment of the alignment may be needed.

**FREQUENTLY ASKED QUESTIONS:**

**Q1:** I am trying to enlarge the image on my phone but its still a small circle, what can I do?

**A1:** To maximize your image, select video mode and/or pinch your phone screen to digitally zoom. Depending on the combination of your phone and optic, you may need to use the included lens spacer. Insert and snap lens spacer into place as shown in figure below, and then reattach to optic. If image size does not increase, remove lens spacer or that phone and optic combination.

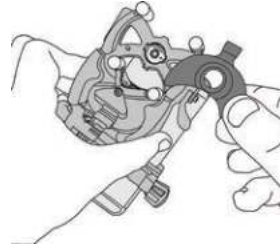

Squeeze open optic clamps and insert lens spacer in between clamps.

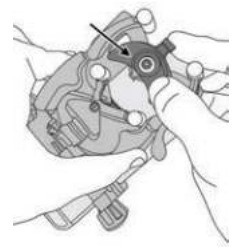

Snap lens spacer into place.

**Q2:** The top clamp touches the round corner of my phone not the top flat edge of my phone. What do I do?

**A2:** This is normal for some models of phones. Just push as flush to rounded edge as possible and lock top clamp as normal.

**Q3:** I can't align my phone with the top clamp. It won't fit. What should I do?

**A3:** If you go through the alignment process (Fig. 7-11), and there is no way to achieve alignment because it's restricted by the top clamp, try removing your phone case. If your phone will still not allow the primary lens to align with the camera cutout, follow steps to remove top clamp and replace with **alternate clamp (included)**.

1. Using a #2 Phillips head screwdriver, remove screw, washer and top clamp (Fig. A-B).
2. Reassemble adapter with alternate clamp, washer and screw (Fig. C).

Your primary lens should now align with camera cutout. If you did not receive the longer alternate clamp, contact customer support and we will ship it to you for free.

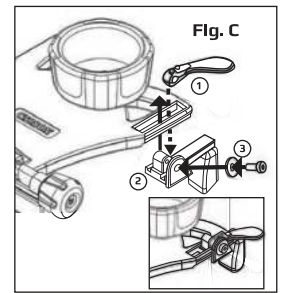
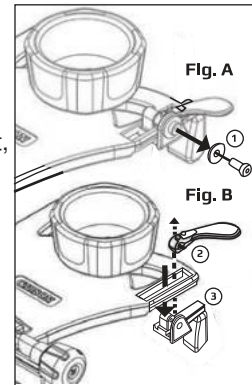

**Q4:** Can I use this on my rifle scope?

**A4:** No, it is not recommended because of the long spacing required between the eyepiece of a rifle scope and your eye so that the image is very small on your phone screen. Also, we do not suggest using a firearm with the adapter on a rifle scope, due to recoil.

**Q5:** My image is not centered or is not a complete round image, what is wrong?

**A5:** Adjust phone alignment in vertical direction using top clamp (Fig. 10), and in horizontal direction by using alignment screw (Fig. 8). Check that phone is flat on adapter (Fig. 6), and adapter is flush with optic (Fig. 17).

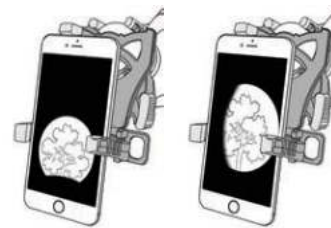

**Q6:** My phone rotates on the eyepiece when used in landscape (horizontal) mode. What should I do?

**A6:** If the eyepiece can rotate on your optic, then you can try the following:

1. If your eyepiece can rotate outward, then you must place adapter in orientation to counter the rotation.
2. If the eyepiece has any method to secure from rotation such as a screw set, use it to lock down the eyepiece.
3. If above solutions are not possible or do not work for your application, it may not be possible to use in this mode. Please use only in portrait (vertical mode).

## FREQUENTLY ASKED QUESTIONS CONTINUED:

**Q7:** Why am I getting reflections and/or glare in my image?

**A7:** If there are bright spots in the image itself, this may occur with indoor lighting. Please avoid overhead lighting or change the angle of the lighting relative to the phone. Also, please use without flash to avoid reflections and/or glare in photos. If there's glare on your phone screen that makes image hard to view, increase brightness setting on phone and view from a position with less overhead light.

---

**Q8:** My other phone camera or flash is covered by the adapter. Why is that?

**A8:** First, we recommend using the device with only the primary rear camera. If problems persist, please contact customer support. Second, the flash can be covered, and is not needed for use with optic. We recommend flash setting is turned off at all times when using adapter.

---

**Q9:** I have a large eyepiece, but it seems like it won't fit or it's too tight to get one, what do I do?

**A9:** For eyepieces at the maximum range (58-62mm), the adapter must be opened to its maximum, and then some pressure must be used to push the adapter over the eyepiece. Any eyepiece beyond 62mm in external diameter should not be used with this adapter. For these largest eyepieces, do not use the optic lock. Also, it's important not to leave the adapter attached to these largest eyepieces for longer than two continuous hours, as it could cause permanent wear to the springs.

---

**Q10:** The adapter is sagging on the eyepiece and not staying flush, what do I do?

**A10:** Make sure once the adapter is flush on the optic, to use the optic lock as shown in Fig. 18.

---

**Q11:** Does this work on a tripod?

**A11:** The adapter itself does not have a tripod mount. However, for best stabilized images and videos, we suggest the optic used is mounted to a tripod.

---

## TIPS AND TRICKS:

### PHOTOGRAPHY

- Tap object of interest on your phone screen to autofocus.
- For videos, tap and hold object of interest on phone screen for a second to lock focus. Tap again to release the focus lock.
- In low light conditions, turn your phone screen brightness to its lowest level. The rubber parts glow in the dark making it easier to use the adapter.
- For long sessions, try using battery cases or phone chargers to prevent your battery from draining.

### APPS

- Share photos and videos through various apps (e.g. FaceTime, Messages, Facebook, Instagram, etc.)
- Apps that allow you to set exposure and focus manually can expand the potential of the adapter. This is especially helpful for telescopes to set longer exposure times to get the best images of sky objects.

### STABILIZATION

- To prevent shaking:
  1. Use your headphones. Volume button will now act as shutter button.
  2. Attach to tripod.
- Many phones have image stabilization features. Check your phone and turn on this feature if available. If not, there are camera apps with stabilization features.



## SMARTPHONE SIZING GUIDE

If your phone (in its case) fits in "portrait" orientation between the 2 arrows, it will fit the HookUpz™2.0 Adapter.

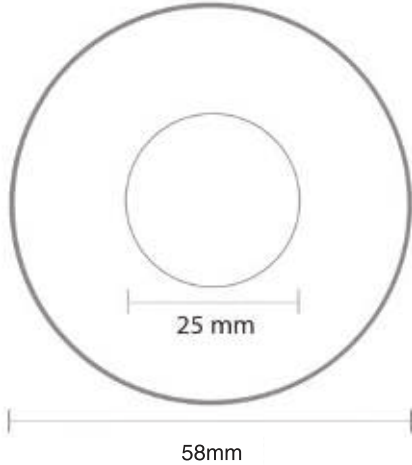

Diagram is to scale.

### OPTIC SIZING INSTRUCTIONS:

2. If your optic's eyepiece fits in between the 25 mm to 58 mm circles, then the Hookupz 2.0 will fit your optic!
- \* 3. For eyepieces up to 60 mm, push firmly to secure.



### CLEANING / STORAGE:

- Adapter should be cleaned with a soft, damp microfiber cloth only. Do not use any chemicals, abrasives, or solvents.
- To avoid damage, always store adapter in protective case when not in use.
- Do not leave item attached to optical device as this may weaken the springs over time.
- Store in dry area at room temperature.

**Customer Service:** If you experience any difficulties, please contact us and we will be happy to help you.

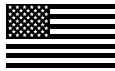

✉ info@carson.com



✉ uksupport@carson.com



✉ eusupport@carson.com

**For warranty information, visit [www.carson.com/warranty](http://www.carson.com/warranty)**

**[www.carson.com](http://www.carson.com)**

Carson Optical 2070 5th Avenue, Ronkonkoma, NY 11779 | Tel: 631-963-5000