

ATHLON

RIDICULOUSLY GOOD OPTICS

MIDAS 1 MILE LEASER RANGEFINDER



**USER MANUAL &
CARE INSTRUCTIONS**

RANGEFINDER ELEMENTS

- ① "Mode" Button
- ② "Ranging"/"Power" Button
- ③ Eyepiece
- ④ Battery Compartment
- ⑤ Laser Receiving Objective
- ⑥ Laser Emission Objective

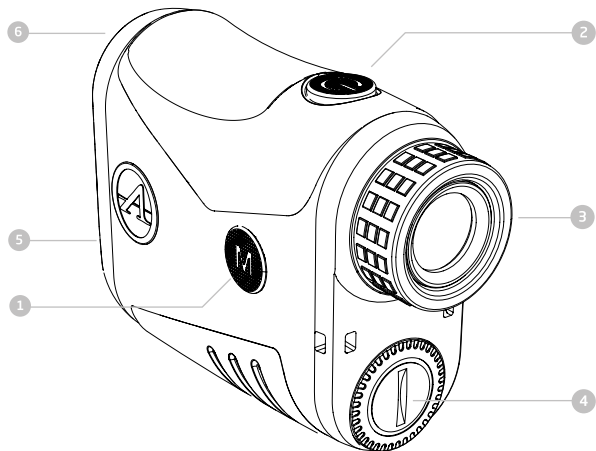

STARTUP AND SHUTDOWN

1. Remove the battery cap below the eyepiece and insert a CR2-3V battery into the battery chamber, having the positive side facing out, then close the battery cap.

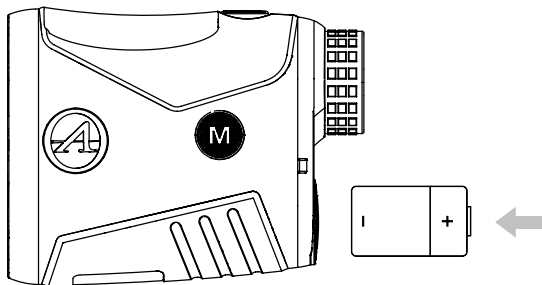

2. Short press  button to power the unit ON. You should see the startup display by looking through the eyepiece.
3. Laser Range Finder will automatically power off after idling for more than 10 seconds.

EYEPIECE LCD DISPLAY



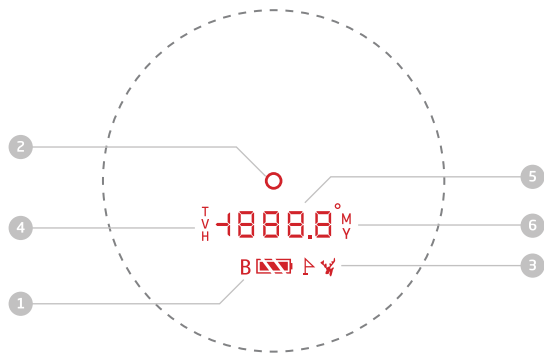

- 1 Battery Indicator;
- 2 Aiming Reticle;
- 3 Golf Mode / Hunting Mode
- 4 Incline Angle, Horizontal Distance, Vertical Distance Mode Sign;
- 5 Distance and Auto function Display;
- 6 Unit: M -- Meter, Y -- Yard.



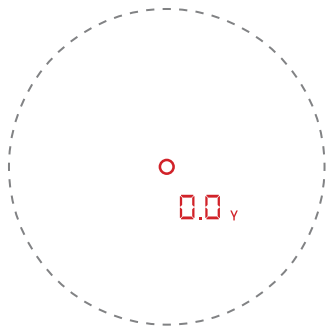

MENU OPERATIONAL FLOWCHART

1. **Power ON:** Short press  to power on. The startup screen will display the last used mode. After 10 seconds of no-operation the display will power off automatically.





2. **Menu select:** Long press  button for 2 seconds to enter the mode setting menu. Using the  button you can scroll through the icons. Short press  button to advance to the next screen. In mode setting menu long press  button for 2 seconds to return to ranging display.

MENU SCREENS

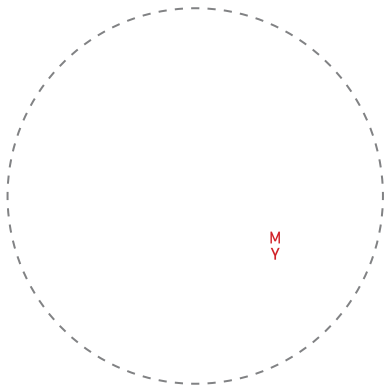
1. **DISTANCE UNIT SWITCHING:** "M" or "Y" will start blinking. Short press  button to select "M" or "Y" for Meters or Yards. Short press  button to confirm the item you selected or skip this option.



2. **RANGING MODES:** "T", "V", "H" or OFF will start blinking. Short press  button to select "T" for Tilt Angle, "V" for Vertical Distance, "H" for Horizontal Distance, "OFF" for no angle display (LOS mode). Short press  button to confirm the item you selected or skip this option.

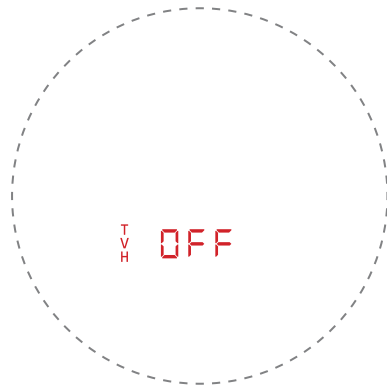

a. **LOS mode (OFF):** Aim the reticle at the target. Short press  button once to measure the distance. Only the linear distance of the ranging is displayed.

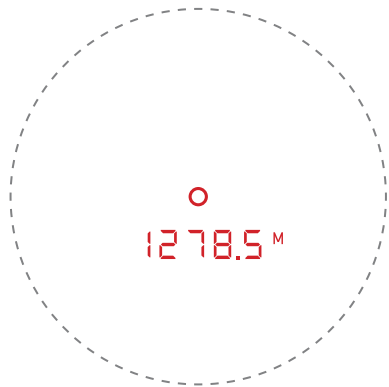

b. **Tilt Angle mode (T):** Aim the reticle at a target. Press the  button once to measure the distance. The linear distance of ranging is displayed first (1). After 1 second, Angle value is displayed (2). After another second, display returns the linear distance of ranging (3).

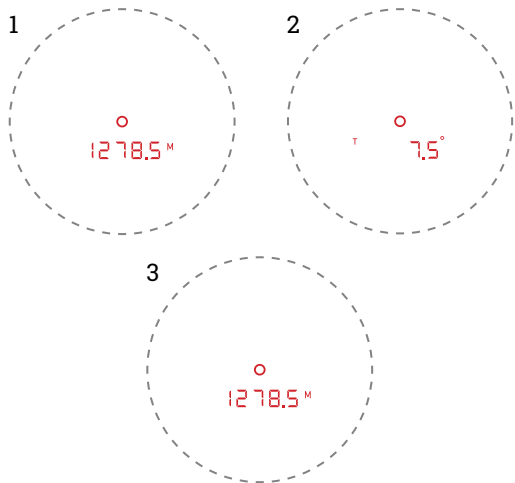

c. Vertical Distance mode (V): Aim the reticle at a target. Press the  button once to measure the distance. The linear distance of ranging is displayed first (1). After 1 second, the Vertical Distance is displayed (2). After another second, display returns the linear distance of ranging (3).

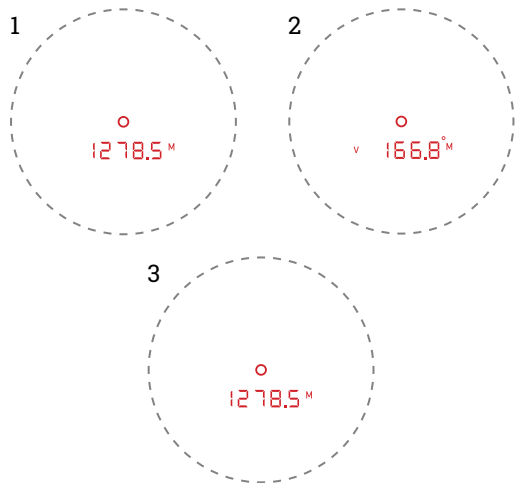

d. Horizontal Distance mode: Aim the reticle at a target. Press the  button once to measure the distance. The linear distance of ranging is displayed first (1). After 1 second, the Horizontal Distance is displayed (2). After another second, display returns the linear distance of ranging (3).

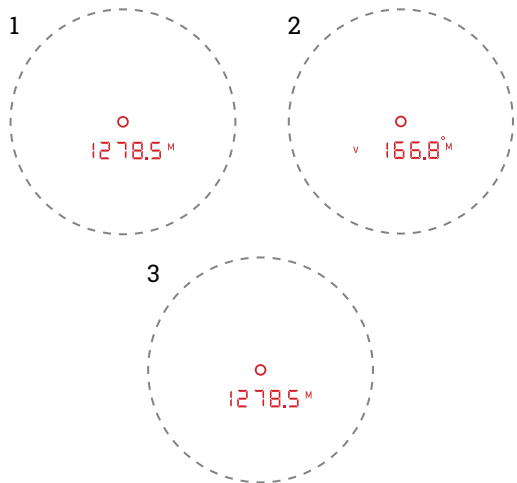

3. **MEASURING METHOD SELECTION:** "Auto", "Flag", "Deer" will start blinking. Short press  button to select "Auto" for Regular Mode, "Flag" for Golf Mode, or "Deer" for Hunting Mode.

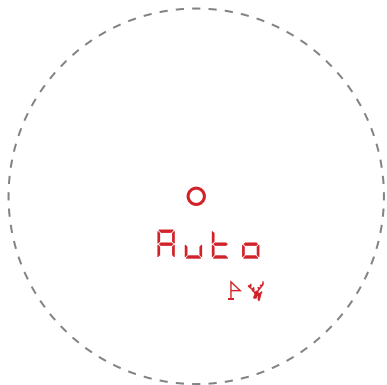

- a. **Regular Mode:** In Regular Mode hold  button while aiming at the target for scanning. The distance value on the screen varies with the target.

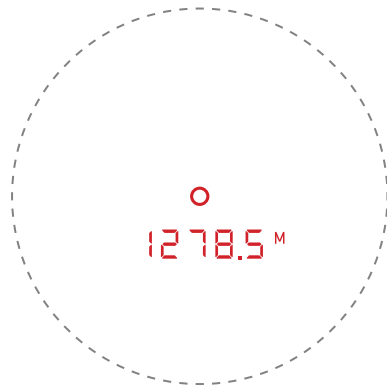

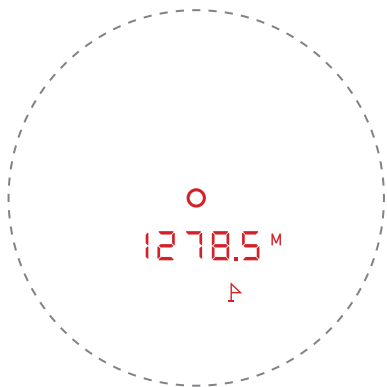

b. Golf Mode: In a group of targets, hold the  button while aiming at the target for scanning. The nearest target is locked first. The values displayed on the screen do not change (nearest distance).

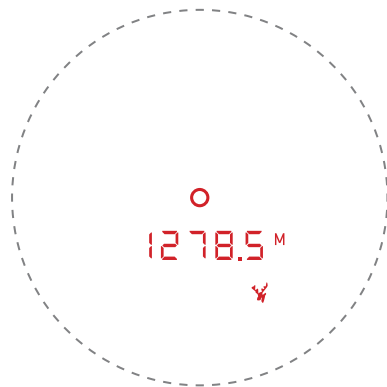

c. Hunting Mode: In a group of targets, hold the  button while aiming at the target for scanning. The farthest target is locked first. The values displayed on the screen do not change (farthest distance).



4. **DISPLAY BRIGHTNESS ADJUSTMENT:** Short press  button to select between level 1 to 4 display brightness. Press  button to confirm the item you selected or skip this option and return to ranging.

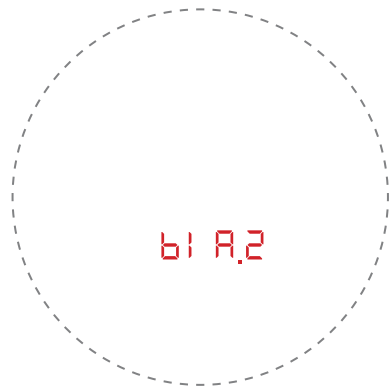

LOW BATTERY INDICATION

When the voltage is less than 1.5v, Low Battery Indication is displayed.

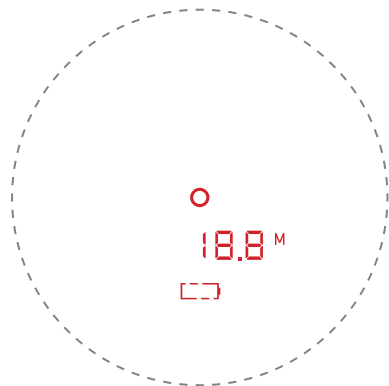

THE ATHLON GOLD MEDAL LIFETIME WARRANTY*

Your Athlon product is not only warranted to be free of defects in materials and workmanship for the lifetime of the product. Athlon will also repair or replace, at no charge to you, your product if you should damage it through normal use. No receipt is needed, no registration is required. This is a commitment that Athlon Optics will be the best product you can buy for your money.

**This warranty does not cover damages caused by deliberate damage, misuse, theft or maintenance provided by someone other than the Athlon Authorized Service Department.*



**SHARP, TIGHT
AND PRICED
JUST RIGHT!**

Toll free: 1-855-913-5678

contact@athlonoptics.com

**801 N MEADOWBROOK DR,
OLATHE, KS 66062**

ATHLONOPTICS.COM