

ATHLON
RIDICULOUSLY GOOD OPTICS

APLR2 FFP IR MOA

Argos BTR GEN2 Riflescope

FIRST FOCAL PLANE

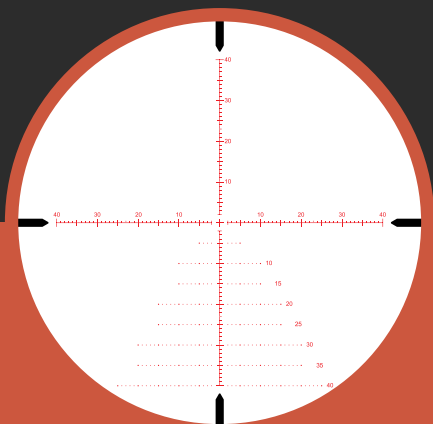

RETICLE MANUAL

THE ATHLON® APLR2 FFP IR MOA RETICLE

APLR2 FFP IR MOA reticle is illuminated all the way with 1 moa hash mark increments and drop lines in 5 moa increment on vertical direction down to 50 moa, both of which help you quickly lock in your target and set holdover positions. The reticle has a 2 moa span center cross with illuminated cross line extends to 40 moa on both vertical and horizontal direction. The drop lines have smaller dots with 1 moa in between and bigger dots at each 5 moa interval, starting 5 moa length horizontally and ending up 50 moa in length at the 40th moa drop line. The illuminated reticle provides excellent low light visibility and accurate elevation holdovers all the way up to 40 moa with 1 moa markings increment. The unique design of having droplines going down to 40 moa with 5 moa between each drop line and 1 moa hash marks in between provide excellent holding over positions for long precision shooting.

Application: Precision Mid and Long Range Shooting for both Tactical and Hunting

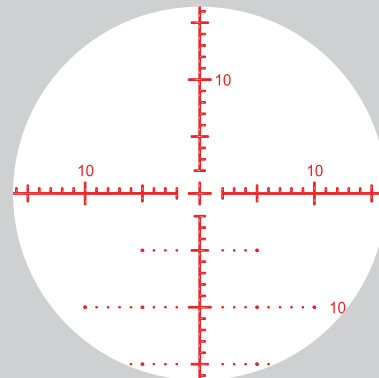
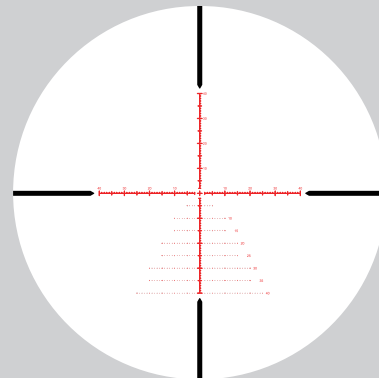

Note: The reticle image shown above will appear differently among different models due to different magnification and location of the reticle.

RETICLE SUBTENSIONS

The APLR2 FFP IR MOA reticle is based on the minute of angle, a unit of angular measurement, usually shortened to moa. A "moa" is defined as "one minute of an angle". As a full circle has 360 degrees, and each degree is composed of 60 minutes (60'), thus there are 360 (degrees) x 60 (minutes) = 21,600 minutes in a circle. Since there are 360 degree in a circle, we can get 360 degree/21600 minutes = 0.016667 degrees/minute. If the target is 100 yards (3600 inches) away, we can use a formula, $3600 * \text{TAN}(\text{RADIANS}(.016667))$, to get 1.047 inches which means 1 moa equals to 1.047 inches at 100 yards. Many people just round down the 1.047 inches to 1 inch @100 yards. If you are using metric system, formula $10000\text{mm} * \text{TAN}(\text{RADIANS}(.01667))$ gets you that 1 moa equals to 29.1mm @100 meters.

The APLR2 FFP IR MOA reticle is located at the focal plane in the front of the erector tube which is a key part of achieving variable power inside the rifle scope. Size of the first focal plane reticle grows or shrinks at the same ratio with the changing size of the image of your target when you try to zoom in or zoom out. Since the size of the reticle remains constant compared to your target regardless of the magnification, the subtension of the reticle remains valid all the time. The reticle at 4.5x actually becomes a center cross for effectively engaging shorter range targets while at 30x or other high power settings it provides finer details for a shooter to locate proper hold over positions for long range targets.

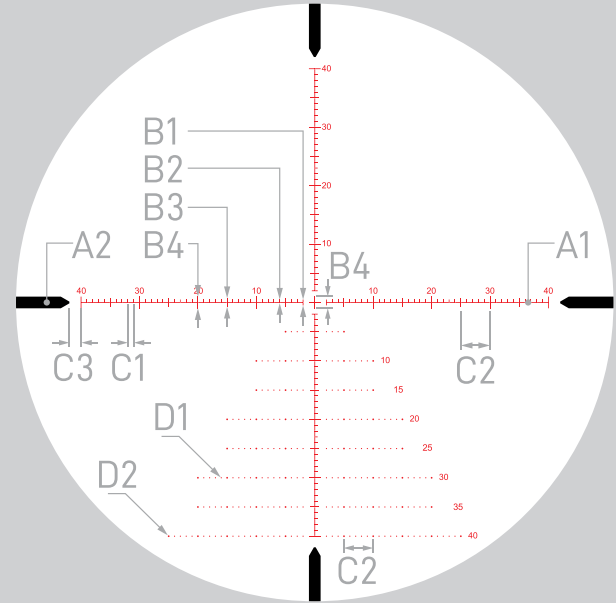

SUBTENSIONS IN MOA

A1	A2	B1	B2	B3	B4
0.14	2	1	0.5	1.5	2
C1	C2	C3	D1	D2	
1	5	2	0.2	0.3	

DISTANCE RANGING

Equations for ranging distance to a target using moa

$$\frac{\text{Height of Target (Inches)} \times 100}{\text{MOA Reading on Reticle}} = \text{Distance to Target (Yards)}$$

$$\frac{\text{Height of Target (CM)} \times 34.4}{\text{MOA Reading on Reticle}} = \text{Distance to Target (Meters)}$$

As the height of target and moa reading on the reticle are two key variables in this equation, you have to get an accurate value for those two as much as possible. First all you want to put your rifle on a steady rest so you can get an accurate reading of the target height on the reticle. If needed using the smallest measurement on the reticle to get the most accurate readings. Second use your best knowledge on the height of the target, such as 72 inch high fence or 45 inch shoulder high of white tail deer, to give a value of the target height. Once you got the reading on reticle and your estimate of the target height, you can just simply use above equations to calculate the distance to your target.

EXAMPLE

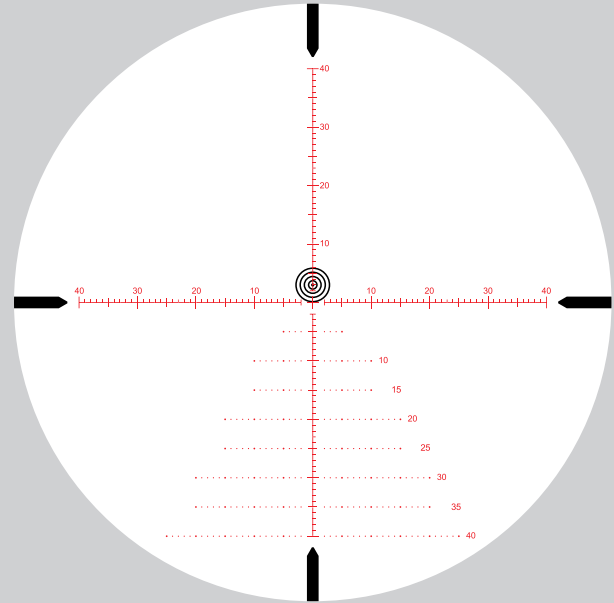

Reading a 3-foot target (36 inches) at 6 moa gives 600 yards

$$\frac{36 \text{ inches} \times 100}{6 \text{ moas}} = 600 \text{ yards}$$

HOLDOVER FOR COMPENSATING BULLET DROP

To be able to use the elevation holdovers effectively, you have to know the distance to your target and bullet trajectory (bullet drop in inches or moa). Since many bullet ballistic charts highlight bullet drops in inches and 1moa equals to 1.047 (rounded down to 1 inch) at 100 yards, 2 inches at 200 yards, and 10 inches at 1000 yards, etc, we can use those to calculate the holdover position in moa on this reticle.

For example, under no wind condition, if you knew your target is at 300 yards and your ammo has a 12 inch bullet drop at that distance, you want to use 4 moa holdover point. Here is how you got the 4 moa: since 1 moa equals to 1 inch x 3 = 3 inches at 300 yards, and then 4 moa equal to 4 x 3 inches =12 inches at 300 yards, you want to hold the 4 moa drop point to compensate the 12 inch bullet drop.

To achieve ultimate precision, it is always a better idea to develop your own D.O.P.E (Data of Previous Engagement)chart so that you can refer back to it for specific bullet drop compensation under different ambient environment and weather condition.

EXAMPLE

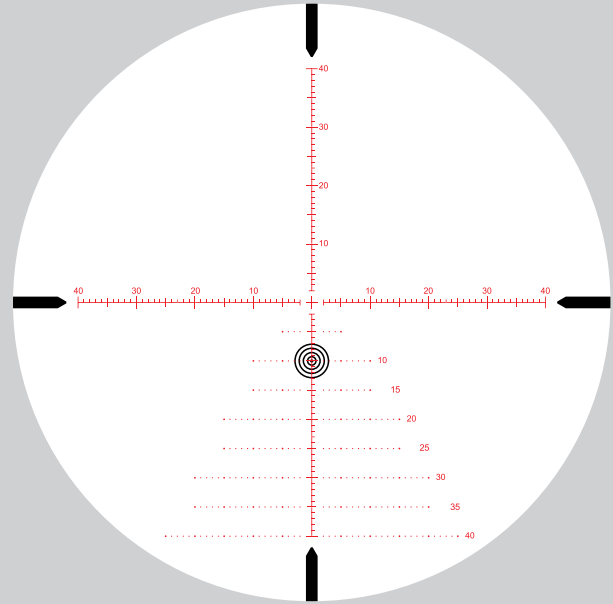

10 moa /60 inch holdover for a target @ 600 yards out. No wind.

HOLDOVER FOR WIND CORRECTION AND MOVING TARGET

The APLR2 FFP IR MOA reticle again has 1 moa mark increment both vertically and horizontally from the 2 moa center cross which can help you set your holdover positions to compensate wind correction and hold the lead for a moving target.

The flying time of a bullet, the velocity and direction of the wind and the "slippery-ness" of the bullet expressed in BC (Ballistic Coefficient) determine your holdover for wind correction. Once again you have to understand the impact of those three factors on your bullet's flying path in terms of inches or mils and calculate how much holdover you have to hold, and then finding the corresponding holdover position on the reticle is a much easier task to accomplish.

EXAMPLE

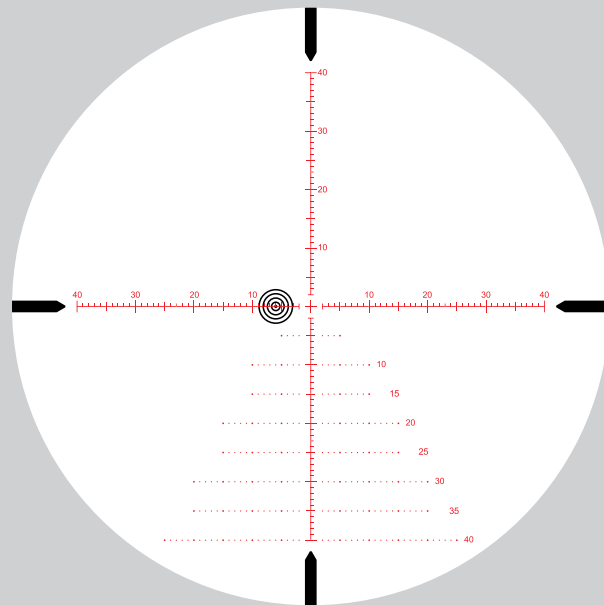

6 moa wind correction for 10 mph wind from right to left @ 600 yards. Elevation turret has been dialed up to compensate bullet drop, just simply use center horizontal cross line to holdover for wind correction

USE VISUAL CROSS POINT FOR WIND CORRECTION AND BULLET DROP

As an alternative, you can use a virtual cross point formed by hash marks on both horizontal and vertical cross lines to holdover bullet drop and wind correction.

EXAMPLE

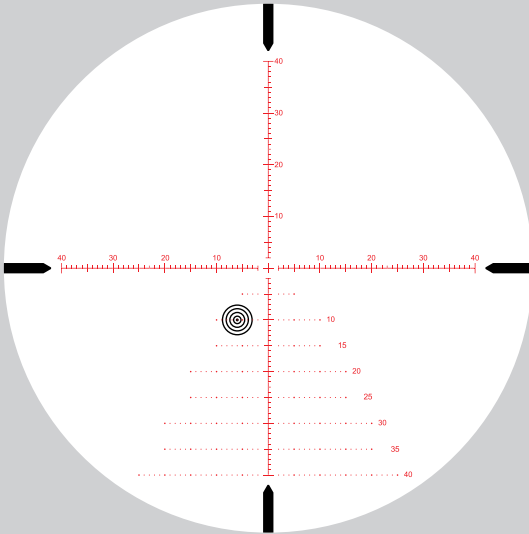

Use 10 moa for 60 inch bullet drop for a target @ 600 yards, 6 moa wind correction for 10 mph wind from right to left.

HOLD LEAD CORRECTION FOR A MOVING TARGET

Distance to your target, moving speed of your target, bullet flying time, wind direction are the key factors that determine how much holdover you need to hold for a moving target. As a rule of thumb, you always hold the lead for the net distance of your target moved (add or subtract holdover for wind correction) during the time span your bullet traveled.

EXAMPLE

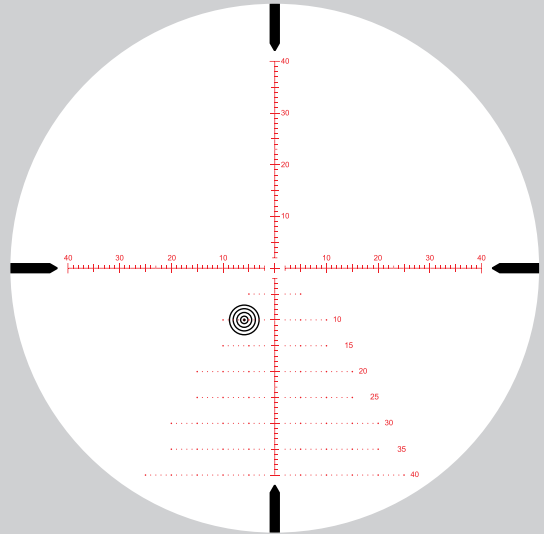

5.9 moa lead holdover for a moving target traveling at 2 mph from left to right at 600 yards. Bullet flight time is 1 second during which the target traveled 2.94 feet. No wind.

THE ATHLON GOLD MEDAL LIFETIME WARRANTY*

Demand the most from your equipment. When things go unexpectedly or accidents happen, rest assured, Athlon Optics carry a lifetime transferable warranty. Athlon guarantees to repair or replace your product if damaged through normal use. No charge; No receipt; No Registration required.

**This warranty does not cover damages caused by deliberate damage, misuse, theft or maintenance provided by someone other than the Athlon Authorized Service Department.*



**SHARP, TIGHT
AND PRICED
JUST RIGHT!**

Toll free: 1-855-913-5678

contact@athlonoptics.com

801 N MEADOWBROOK DR,
OLATHE, KS 66062

ATHLONOPTICS.COM