

ATHLON
RIDICULOUSLY GOOD OPTICS

ATMR2 FFP IR MOA

Ares ETR UHD 1-10x24 Riflescope

FIRST FOCAL PLANE

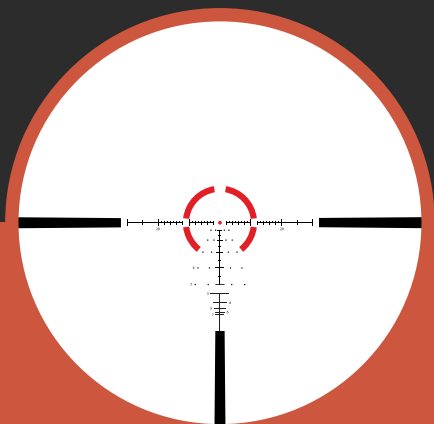

RETICLE MANUAL

THE ATHLON® ATMR2 FFP IR MOA RETICLE

ATMR2 FFP IR MOA reticle is specifically designed for fast close-range situations and mid-range shooting, using a wide array of standard and magnum cartridges. On 1x the 20 moa illuminated quartered ring and 1.2 moa center dot provide the same fast-acquisition capabilities of a standard red dot. Increasing magnification, the holdover and windage subtensions become visible. Featuring unobtrusive .5 moa wind holds for 5 and 10 MPH winds. As a First Focal Plane scope the reticle remains valid throughout the magnification range providing holdovers out to 700 yards. A built-in ranging tree on the lower vertical post provides quick range estimation on a 36" tall silhouette target.

Application: Short and Mid Range Hunting and Tactical application

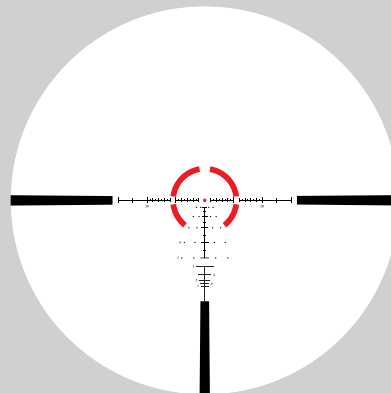
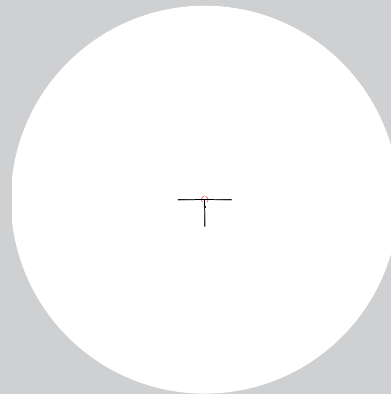

Note: The reticle image shown above will appear differently among different models due to different magnification and location of the reticle.

RETICLE SUBTENSIONS

The ATMR2 FFP IR MOA reticle is based on the minute of angle, a unit of angular measurement, usually shortened to moa. A "moa" is defined as "one minute of an angle". As a full circle has 360 degrees, and each degree is composed of 60 minutes (60'), thus there are 360 (degrees) x 60 (minutes) = 21,600 minutes in a circle. Since there are 360 degree in a circle, we can get 360 degree/21600 minutes = 0.016667 degrees/minute. If the target is 100 yards (3600 inches) away, we can use a formula, $3600 * \text{TAN}(\text{RADIANS}(.016667))$, to get 1.047 inches which means 1 moa equals to 1.047 inches at 100 yards. Many people just round down the 1.047 inches to 1 inch @100 yards. If you are using metric system, formula $10000\text{mm} * \text{TAN}(\text{RADIANS}(0.01667))$ gets you that 1 moa equals to 29.1mm @100 meters.

The ATMR2 FFP IR MOA reticle is located at the focal plane in the front of the erector tube which is a key part of achieving variable power inside the rifle scope. Size of the first focal plane reticle grows or shrinks at the same ratio with the changing size of the image of your target when you try to zoom in or zoom out. Since the size of the reticle remains constant compared to your target regardless of the magnification, the subtension of the reticle remains valid all the time. The reticle at 1x actually becomes a center cross for effectively engaging games at short range while at 10x power settings it provides finer details for a shooter to locate proper hold over positions for targets at long range.

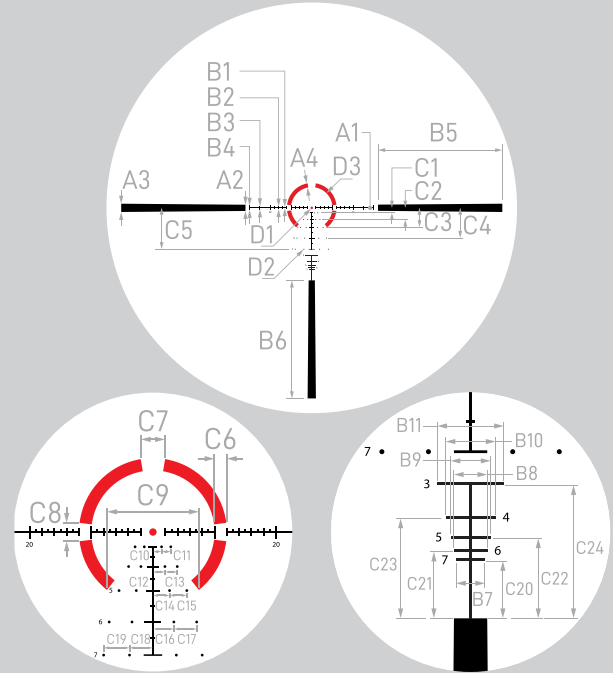

SUBTENSIONS IN MOA

A1	A2	A3	A4	B1	B2	B3	B4	B5	B6	B7	B8	B9	B10
0.25	3	4	2	0.4	1.2	1.5	2	60	57	2.46	2.86	3.44	4.29
B11	C1	C2	C3	C4	C5	C6	C7	C8	C9	C10	C11	C12	C13
5.73	2.4	5.6	9.5	14.6	20	2	4	3	15	1.4	1.5	1.95	2
C14	C15	C16	C17	C18	C19	C20	C21	C22	C23	C24	D1	D2	D3
2.7	2.8	3.4	3.7	3.8	4.2	4.91	5.73	6.87	8.59	11.46	1.2	0.5	20

EXAMPLE

HOLDOVER FOR COMPENSATING BULLET DROP

To be able to use the elevation holdovers effectively, you have to know the distance to your target and bullet trajectory (bullet drop in inches or moa). Since many bullet ballistic charts highlight bullet drops in inches and 1moa equals to 1.047 (rounded down to 1 inch) at 100 yards, 2 inches at 200 yards, and 10 inches at 1000 yards, etc, we can use those to calculate the holdover position in moa on this reticle.

For example, under no wind condition, if you knew your target is at 300 yards and your ammo has a 7.2 inch bullet drop at that distance, you want to use 2.4 moa holdover point. Here is how you got the 2.4 moa: since 1 moa equals to 1 inch x 3 =3 inches at 300 yards, and then 2.4 moa equal to 2.4 x 3 inches =7.2 inches at 300 yards, you want to hold the 2.4 moa drop point to compensate the 7.2 inch bullet drop.

To achieve ultimate precision, it is always a better idea to develop your own D.O.P.E (Data of Previous Engagement)chart so that you can refer back to it for specific bullet drop compensation under different ambient environment and weather condition.

The ATMR2 reticle is designed for 68 and 69 grain BTHP 223 Rem/5.56 mm NATO rounds. It is also suitable for many other bullet weights in these calibers.

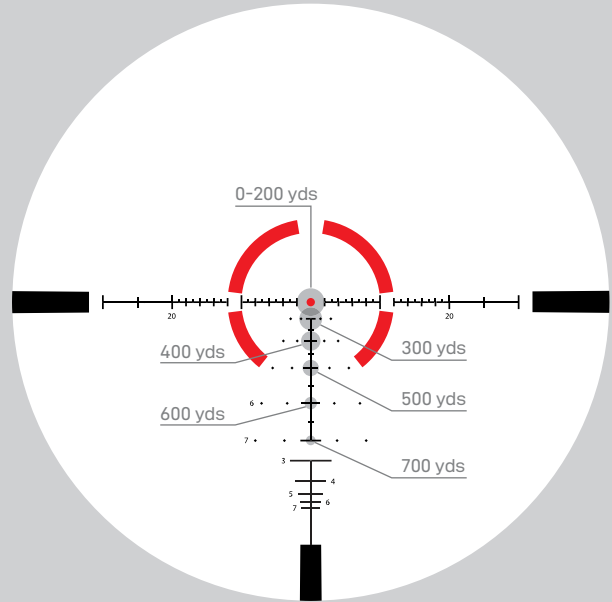

Bullet holdovers for target at every 100 yards. No wind.
Zeroed at 200 yards, ballistic calculation based on 68 grain hornady
and 69 grain sierra cartridge.

HOLDOVER FOR WIND CORRECTION

The flying time of a bullet, the velocity and direction of the wind and the “slippery-ness” of the bullet expressed in BC (Ballistic Coefficient) determine your holdover for wind correction. Once again you have to understand the impact of those three factors on

your bullet's flying path in terms of inches or moa and calculate how much holdover you have to hold, and then finding the corresponding holdover position on the reticle is a much easier task to accomplish.

EXAMPLE 1

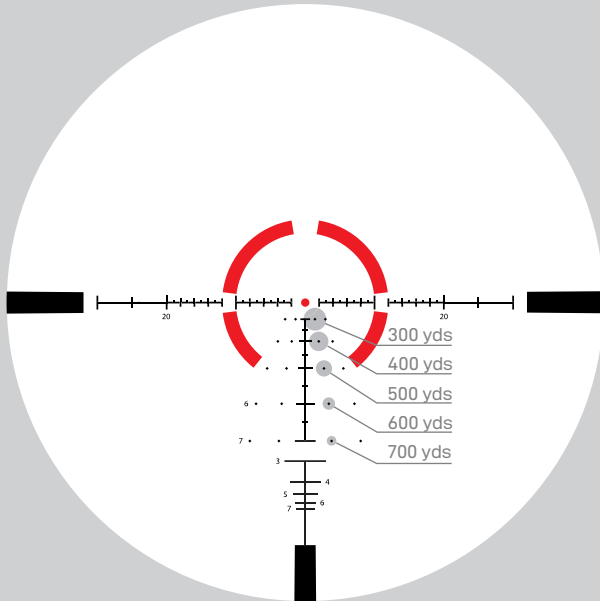

5 mph wind from left to right, holdover for wind correction at every 100 yards.

EXAMPLE 2

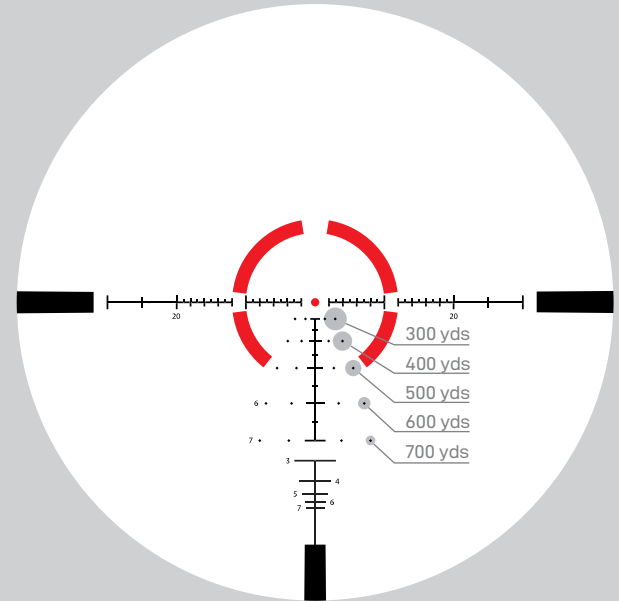

10 mph wind from left to right, holdover for wind correction at every 100 yards.

DISTANCE RANGING RETICLE

EXAMPLE

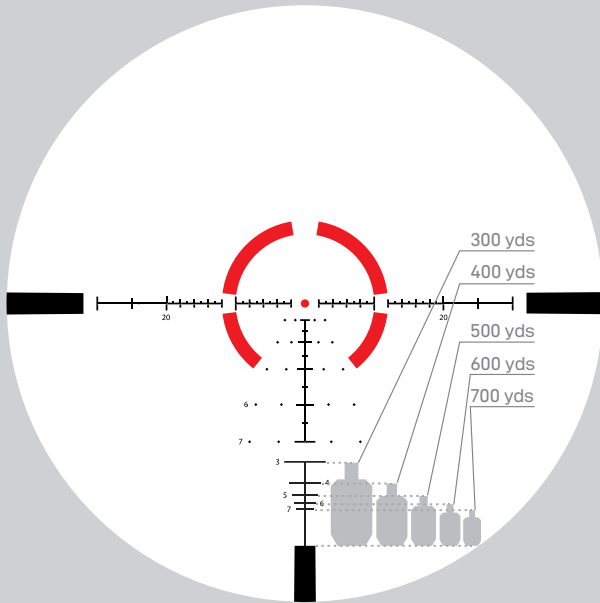

The gap between the ranging reticle line to the top of the thick black line is 36 inches, a height of a standard silhouette target.

DETAIL

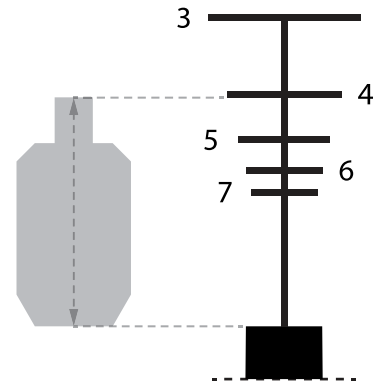

Example of a 36 inch silhouette target at 400 yards.

If you can fit a silhouette target into a gap just call out the distance in hundred yards by using the number beside the horizontal line.

THE ATHLON GOLD MEDAL LIFETIME WARRANTY*

Demand the most from your equipment. When things go unexpectedly or accidents happen, rest assured, Athlon Optics carry a lifetime transferable warranty. Athlon guarantees to repair or replace your product if damaged through normal use. No charge; No receipt; No Registration required.

**This warranty does not cover damages caused by deliberate damage, misuse, theft or maintenance provided by someone other than the Athlon Authorized Service Department.*



**SHARP, TIGHT
AND PRICED
JUST RIGHT!**

Toll free: 1-855-913-5678

contact@athlonoptics.com

801 N MEADOWBROOK DR,
OLATHE, KS 66062

ATHLONOPTICS.COM