



MURPHY DOOR



Video Instructions

OUTSWING DOOR AUTOMATION

Installation Manual



What's in the Box

- AutoSwing Operator
- Push/Pull Arm (Outswing Door)
- Power Supply
- Power Cable Extension
- Four Button Remote
- Safety Sensor
- Electric Lock Cable Connector
- Screw Packet

Tools Required for Installation

- 3 mm Allen wrench
- 10 mm Socket/Wrench
- Drill with #2 bit and 1/16" bit for pilot holes
- Flathead Screwdriver to pop off covers and remove molding/trim
- Level

**Read And Follow All Installation Instructions Carefully!
Failure To Do So May Result In Personal Injury Or Property Damage!**

Before Installation:

- Install only on a properly operating and balanced door. A door that is not operating properly will prevent the operator from working properly and could cause severe injury. Ensure all hardware is properly installed before operating the door.
- Disengage any manual locks to prevent the operator from opening and closing errors.
- If the operator has exposed moving parts, ensure it is out of reach from children and guests.
- Do not connect the door operator to the source of power until instructed to do so. If using a hardwired (non plug) connection to bring power to the operator, use a qualified professional and consult the guidelines of the enforced local electrical codes.

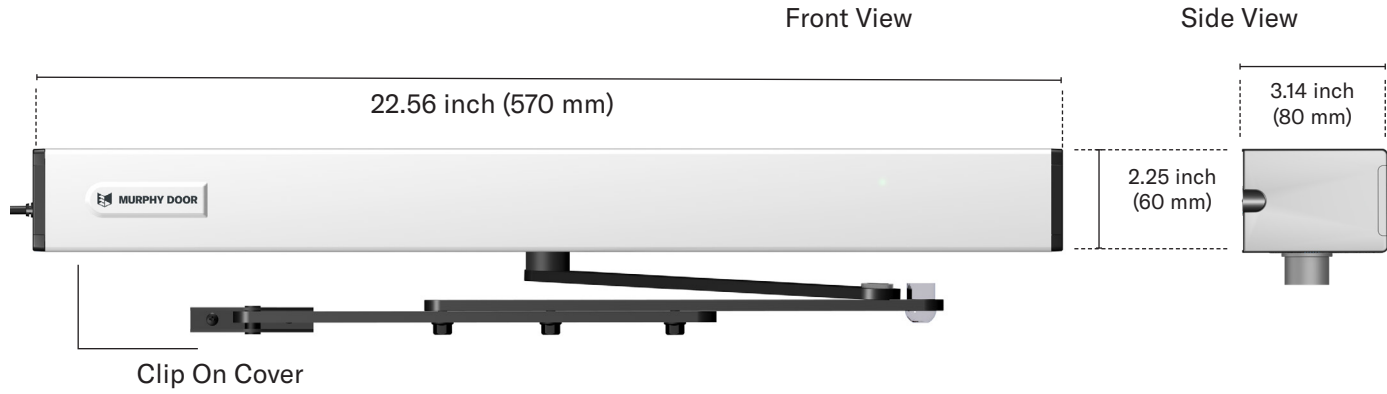

Features

The AutoSwing Automatic Door Operator offers a high standard of performance within a slimline design.

The low height of only 2.25 inches (60 mm), allows the AutoSwing to be mounted to most door headers.

The system comes with a push/pull arm. The combination of these design features and the whisper quiet operation of the mechanism give the doorway a seamless operation.

Voice control with Alexa (requires AutoPlus Gateway).

Operator Features and Performance

- Compact slim design.
- Heavy-duty 24 V motor.
- Modularized components for easy repairs.
- Max 45 lbs. of push/pull force.
- Grant or deny access from the app.
- Motion sensor activation.
- Provide access with eKeys to authorized users and guests.
- Connects with third-party electric strikes and mag locks
- Integrates with Yale and August smart locks (requires AutoPlus Gateway).

Technical Specifications

Operator Type	Hinged, Pivot
Max Door Open Width	48" (1200 mm.)
Pull/Push Opening Force	45 lbs (up to 100 Kg)
Power Input	100-240 VAC 50/60 hz(+,-10%)
Auxiliary Voltage	24 VDC @220 mA
SPDT relay output for controlling electric-strikes or electric locks not to exceed 2A 24 VDC	
Opening Speed	30°/second for normal opening speed; 15°/second for slow opening speed
Closing Speed	8°/second
Hold Open Time	0-23 s

Ambient Temperature	14 °F to 140 °F (-10 °C to 60 °C)
Drive Weight Unit	7 lb (3 Kg)
Complies with:	UL/FCC/ANSI
Compatible Locks	Electric Strike, Mag Lock, Yale and August Smart Locks
Power Supply Adaptor Output	25 Vdc, 2.6 A 65 Watt
Safety Protocol	Auto-Reverse, Safety Beams.
Communication Protocols	RF, Bluetooth, RS485, Dry Contacts
Battery (optional) Backup	14 hours at 1 cycle / min.



OPERATOR

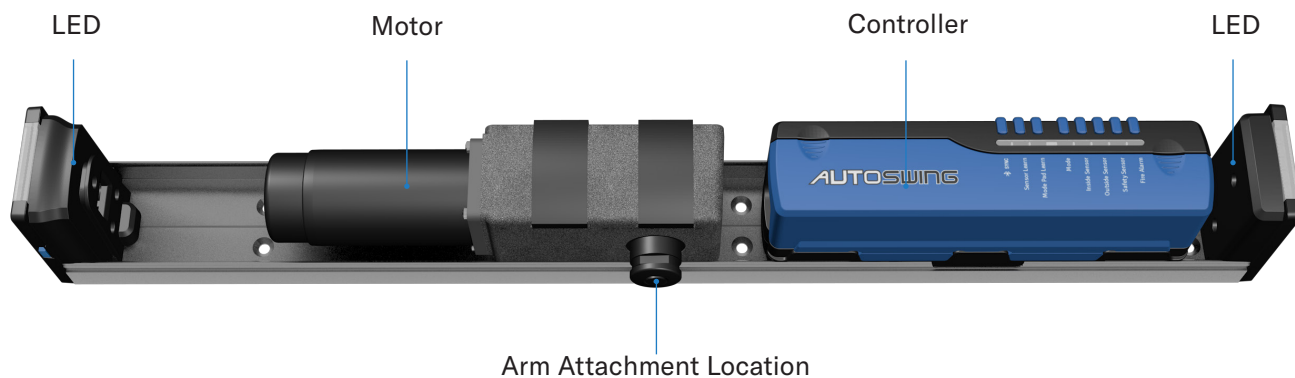

COVER



PUSH/PULL ARM - OUTSWING



POWER SUPPLY



Installation

Installation of the base

Using a flathead screwdriver, unclip off the cover.

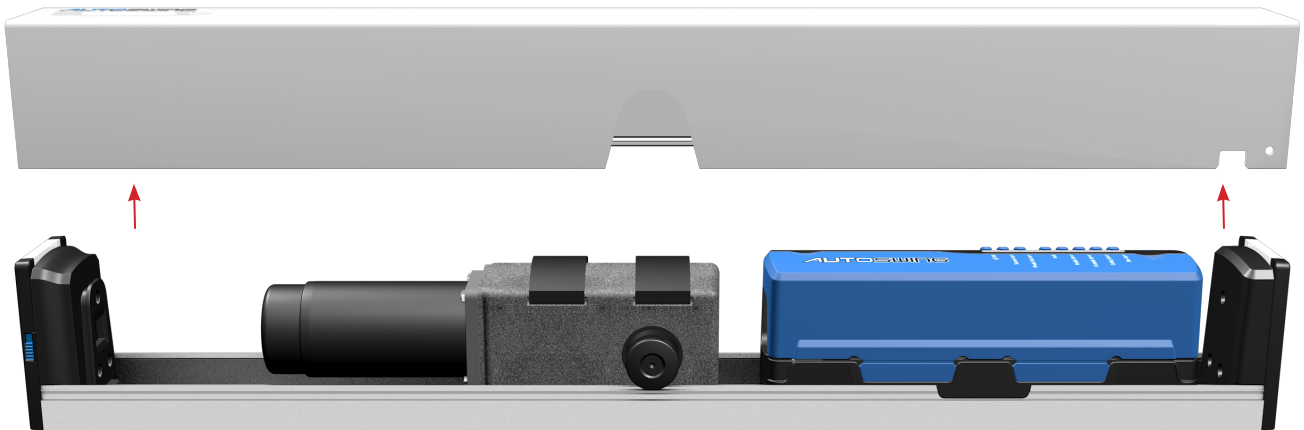
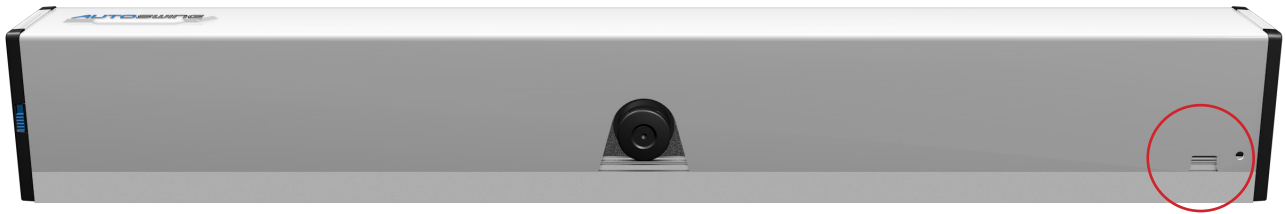

Installation



1 Before beginning, secure the door so it does not move during installation and set up your ladder/stool.

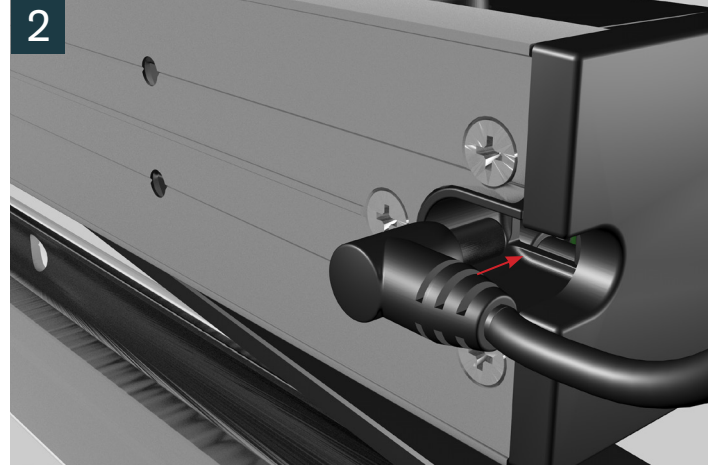

2 Prior to mounting the AutoSwing, plug in the power cable extension.



3 Align the edge of the AutoSwing with the pivot hardware axis of the door (d). The AutoSwing must be aligned with the bottom edge of the door's top jamb. Be sure the operator does not dip below the door jamb.

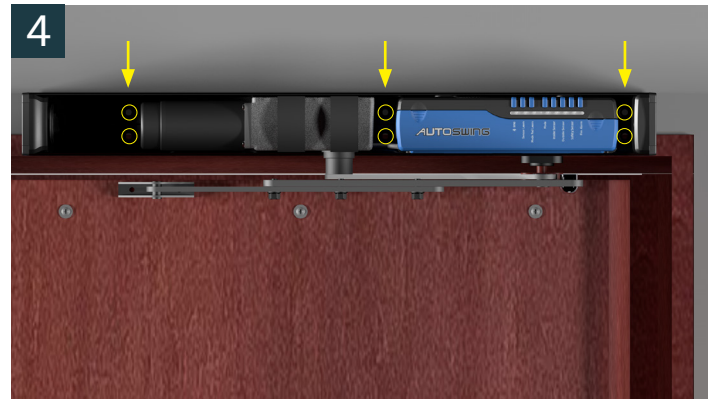

4 After securing the door and connecting the power cord extension, place the operator against the frame.

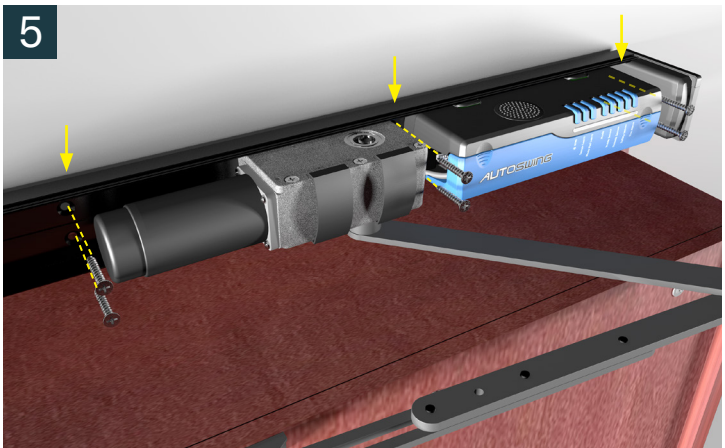

5 Ensure that the bottom of the operator is aligned with the bottom of the top door jamb when mounting the AutoSwing using six screws. Make sure to use the appropriate screws for the material being screwed into.

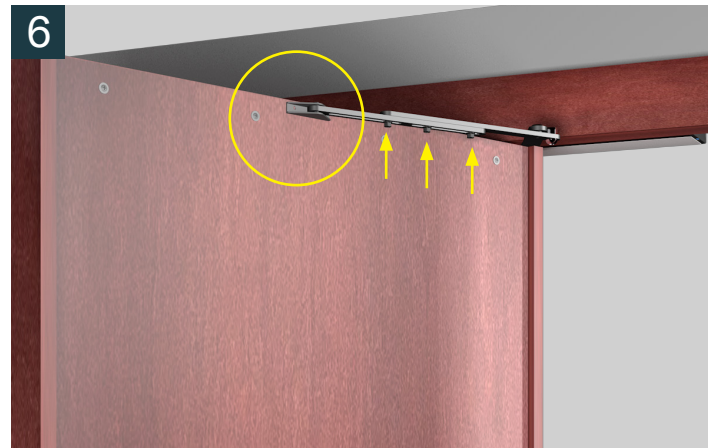

6 Open door to the full position and move arm to the door to locate the position to mount the bracket. You may need to loosen the bolts in the arm to allow for the maximum opening.

Installation

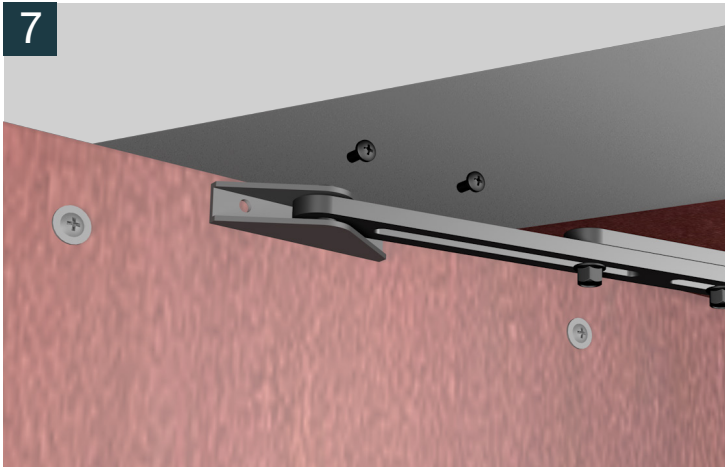

7
Once the position is located, screw the bracket to the door.

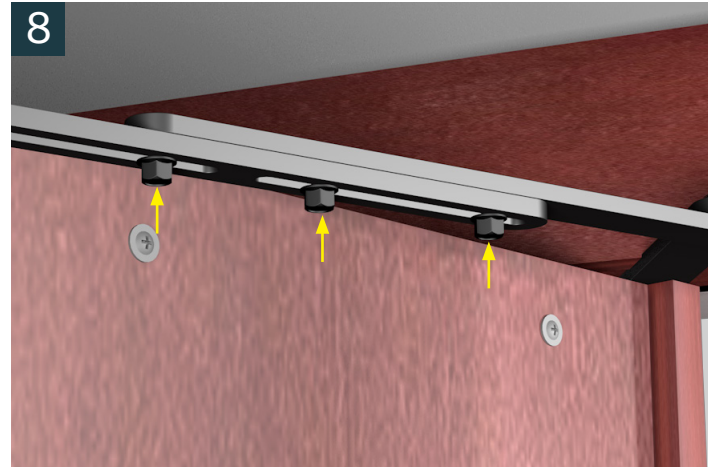

8
Tighten the bolts that were loosened during this process.

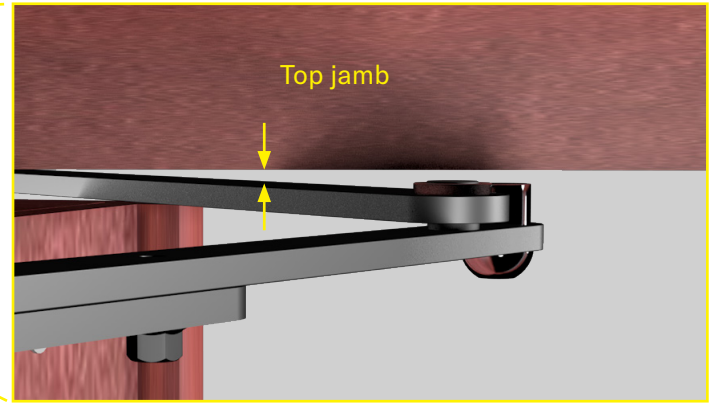
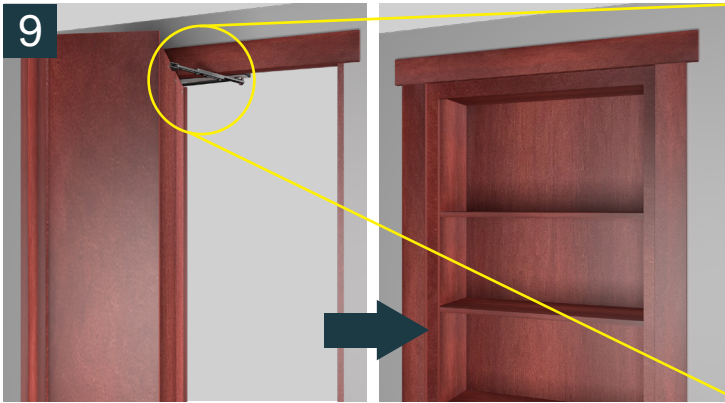

9
After attaching the bracket, manually close and open the door twice to ensure the arm is attached in the correct position and that the arm clears the top of the jamb.



10
Plug the AutoSwing into a 110V outlet. Before powering the operator ON, set DIP Switch #1 to OFF and DIP Switch #6 to the ON positions.

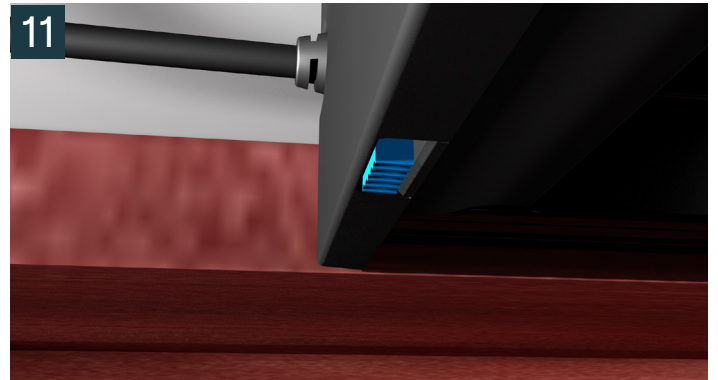

11
Power ON your operator using the power switch located under the left end cap. If the door begins to open, turn the operator OFF and put DIP Switch #1 in the ON position. Turn power back ON and your door will find its closed position.

With the operator powered ON, proceed to program your opening distance using the Autoslide App. See page 10 on how to program your system.



The Controller

Connecting an Electric Lock:

- Maglock: From the lock, connect the power wire to hole #5 on the Lock Port. Then connect the ground wire to hole #4 on the Lock Port.
- Electric Strike: Turn DIP Switch #3 to the ON position. From the lock, connect the power wire to hole #5 on the Lock Port. Then connect the ground wire to hole #4 on the Lock Port.
- Smart Lock: Open the Autoslide app and locate the Smart Integrations section in the Settings window to start the integration process. Follow the instructions in the app. You will need an AutoPlus Gateway to complete the integration.

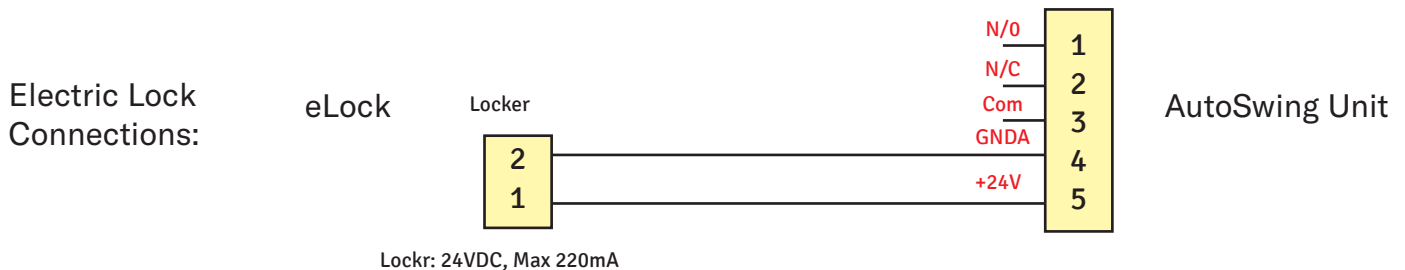

SYNC (Bluetooth Pairing)

The SYNC button is used to pair the AutoSwing to your Autoslide app account using your smartphone or tablet. Download the AutoSlide Pro app from the Apple or Google Play stores.

Sensor Learn

Press this button to pair wireless activation devices to the AutoSwing. A green light will illuminate when the system is ready to pair.

Mode Pad Learn

Use this button to pair a wireless mode pad.

Mode

The Mode button is used to toggle between the four different modes: Unsecured (green), Hold Open (blue), Secure/Locked (red), or Pet (orange).

Inside Sensor

Use the Inside Sensor button to manually activate the system to open the door to the full distance. This channel works in Green, Red, and Orange modes.

Outside Sensor

Use the Outside Sensor button to manually activate the system to open the door through the Outside Sensor input.

Safety Sensor/Pet Sensor

Use the Safety Sensor button to manually activate the system to open the door to the Pet Mode (orange) width. This button will also test the safety sensor feature of the AutoSwing

Fire Alarm

Use this button to test the fire alarm integration if you have your AutoSwing connected to your fire alarm system.

Download the AutoSlide Pro App



- ANDROID: Navigate to the Google Play Store and search for “AutoSlide Pro”, Click INSTALL.
- iOS: Navigate to the App Store and search for “AutoSlide Pro”, Click GET.
- Sign up with your email and set your password.



Programing your AutoSwing (iOS Devices)

- 1** Enable the Bluetooth Connection
Power off your AutoSwing. Turn DIP Switch #6 ON to enable the Bluetooth connection.



- 2** Pairing Your AutoSwing

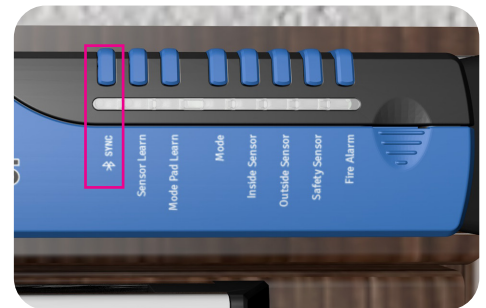
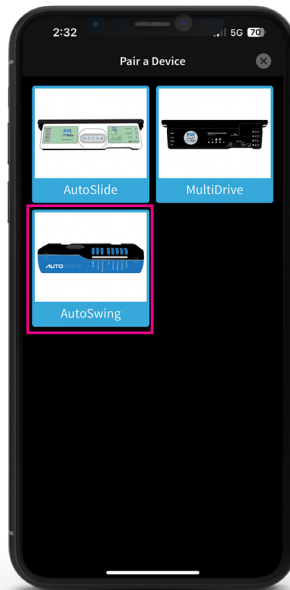
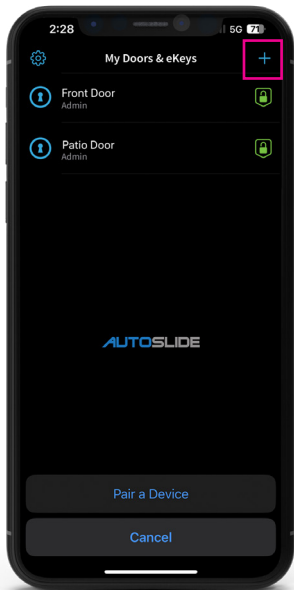

On the My Door & eKeys screen, press the plus (+) symbol to add a new device.

Press the Bluetooth Sync Button on your system when prompted and follow the prompts inside the Autoslide app.

Select AutoSwing from the Pair a Device screen. Follow the instructions inside the app to complete the pairing process.

Configuring The Door Opening Width (iOS Devices)

1

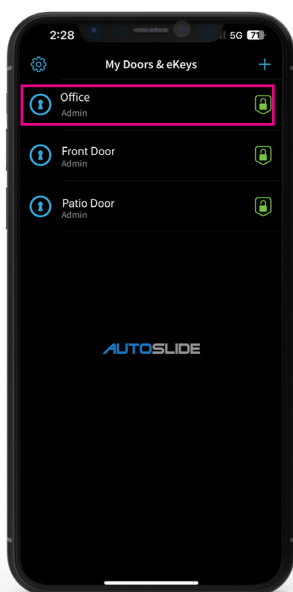

From the My Doors & eKeys screen, select the door you are going to configure.

2

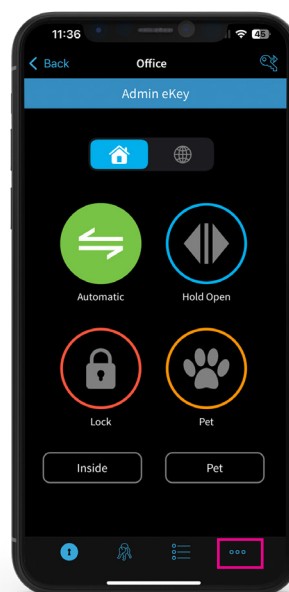

Tap on the three dots icon at the bottom right of the screen.”

3

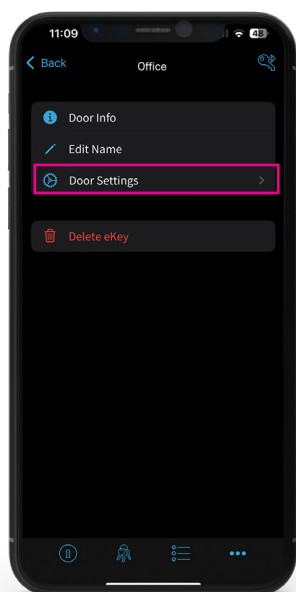

Select Door Settings.

4

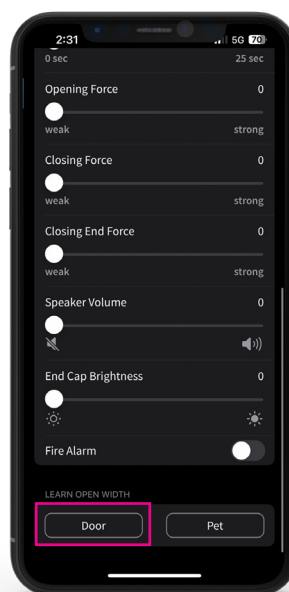

Scroll to the bottom of the Door Settings screen to the section labeled Learn Door Width.

5

Tap the Door button to begin the learning process. When the door reaches the desired maximum open position, press the Door button again to finish the learning process.



Door Settings (iOS Devices)

75% Speed. Reduce the travel speed of the door by 25%. This is used for light doors.

Door Opening Period: Set the amount of time the door will remain open, from 0 to 24 seconds, once it reaches its max open position. To operate the system in a toggle fashion (action to open/action to close), slide the Door Open Period to the max position.

Door Closing Force: Use this slider to increase/decrease the power output of the motor during the closing of the door. This setting comes preset at three (3).

Speaker Volume: Use this slider to increase/decrease the volume of the audio notifications.

End Cap Brightness: Use this slider to increase/decrease the brightness of the LED End Caps. Setting it to zero will turn off LEDs.

Set door opening width.

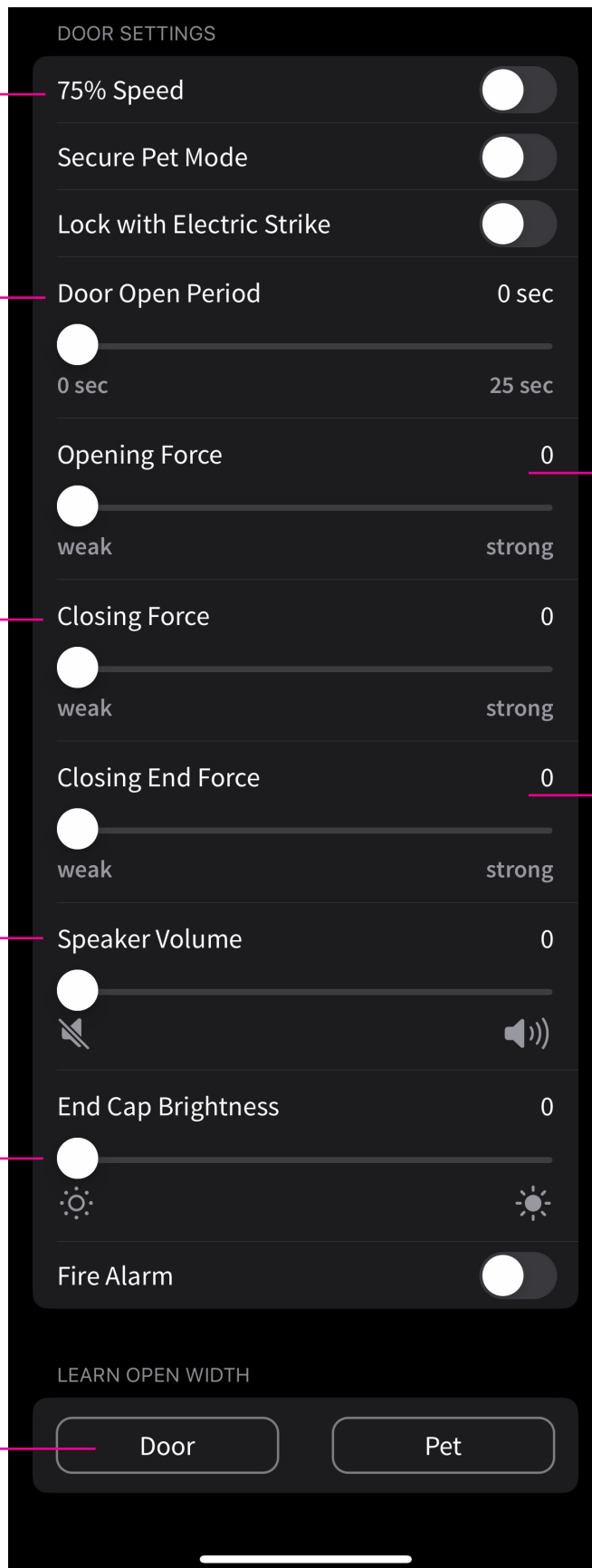

Door Opening Force. Use this slider to increase/decrease the power output of the motor during the opening of the door. This setting comes preset at three (3).

Closing End Force: This setting is to provide extra power to ensure the door engages fully into the door jamb. Most used when doors have tight jambs or high wind pressure areas. This setting comes preset at three (3).

Autoswing App Dashboard (iOS Devices)

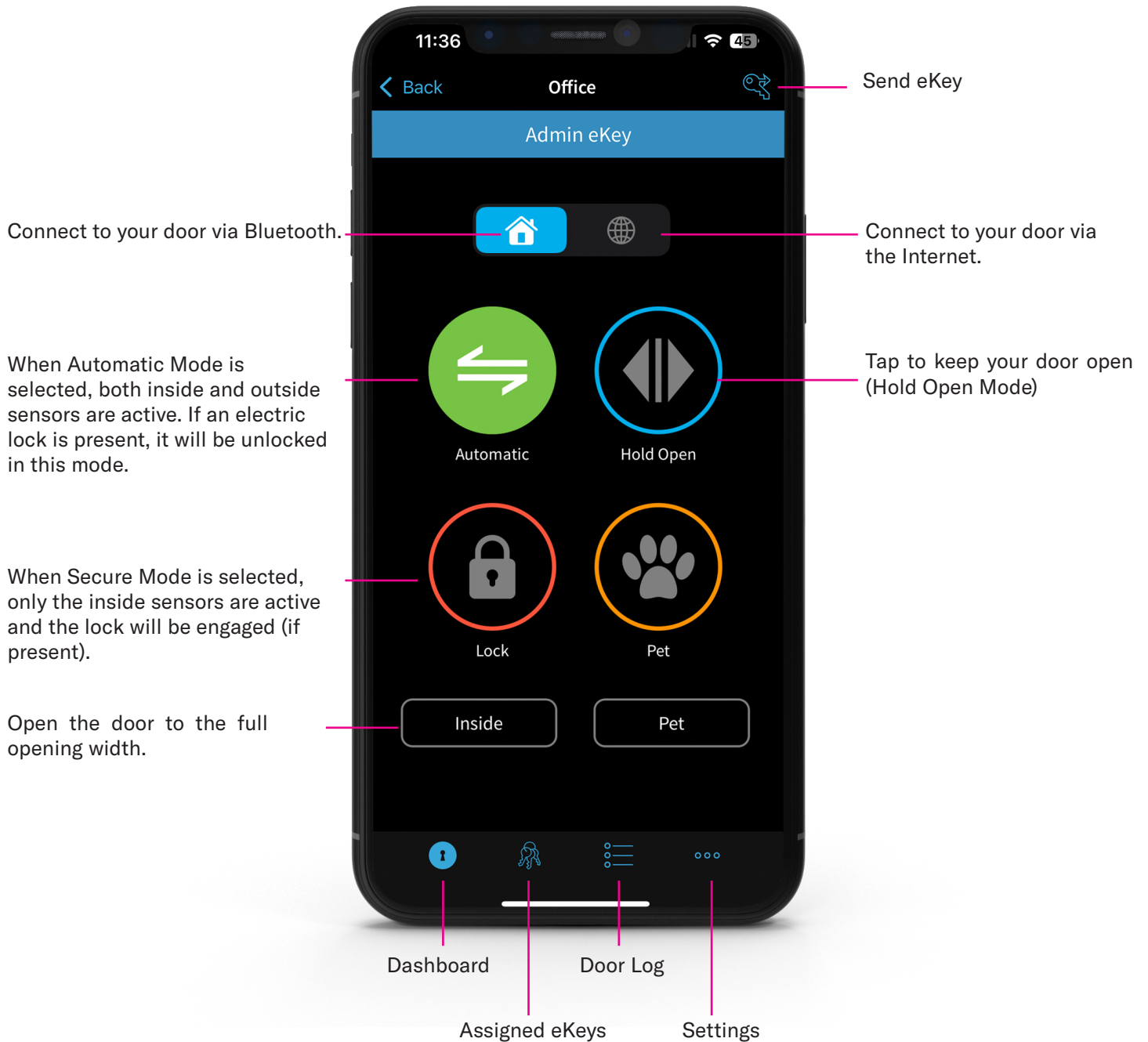

Programing your AutoSwing (Android Devices)

1 Enable the Bluetooth Connection

Power off your AutoSwing. Turn DIP Switch #6 ON to enable the Bluetooth connection.



2 Pairing Your AutoSwing



On the My Door & eKeys screen, press the plus (+) symbol to add a new device.

Press the Bluetooth Sync Button on your system when prompted and follow the prompts inside the Autoslide app.

The app will automatically detect the type of device being paired. Follow the instructions inside the app to complete the pairing process.

Configuring The Door Opening Width (Android Devices)

1



From the My Doors & eKeys screen, select the door you are going to configure.

2

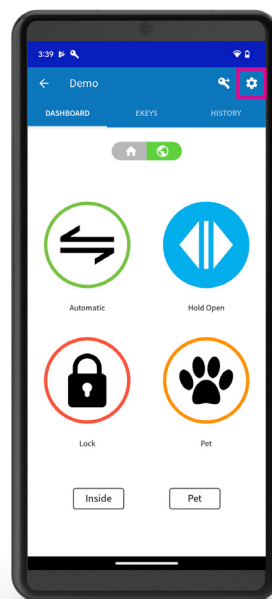

Tap on the cogwheel icon at the top right of the screen.

3

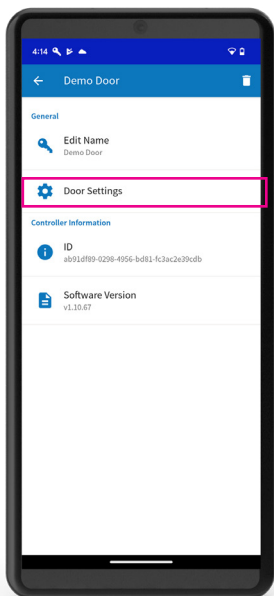

Select Door Settings.

4

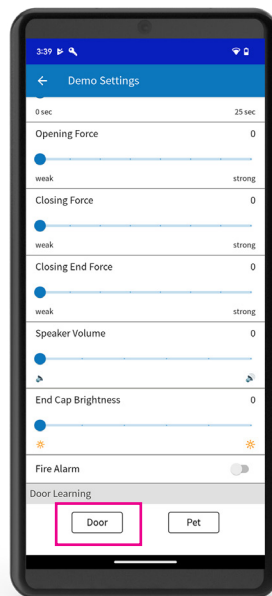

Scroll to the bottom of the Door Settings screen to the section labeled Learn Door Width.

5

Tap the Door button to begin the learning process. When the door reaches the desired maximum open position, press the Door button again to finish the learning process.



Door Settings (Android Devices)

75% Speed. Reduce the travel speed of the door by 25%. This is used for light doors.

Door Opening Period: Set the amount of time the door will remain open, from 0 to 24 seconds, once it reaches its max open position. To operate the system in a toggle fashion (action to open/action to close), slide the Door Open Period to the max position.

Door Closing Force: Use this slider to increase/decrease the power output of the motor during the closing of the door. This setting comes preset at three (3).

Speaker Volume: Use this slider to increase/decrease the volume of the audio notifications.

End Cap Brightness: Use this slider to increase/decrease the brightness of the LED End Caps. Setting it to zero will turn off LEDs.

Set door opening width.

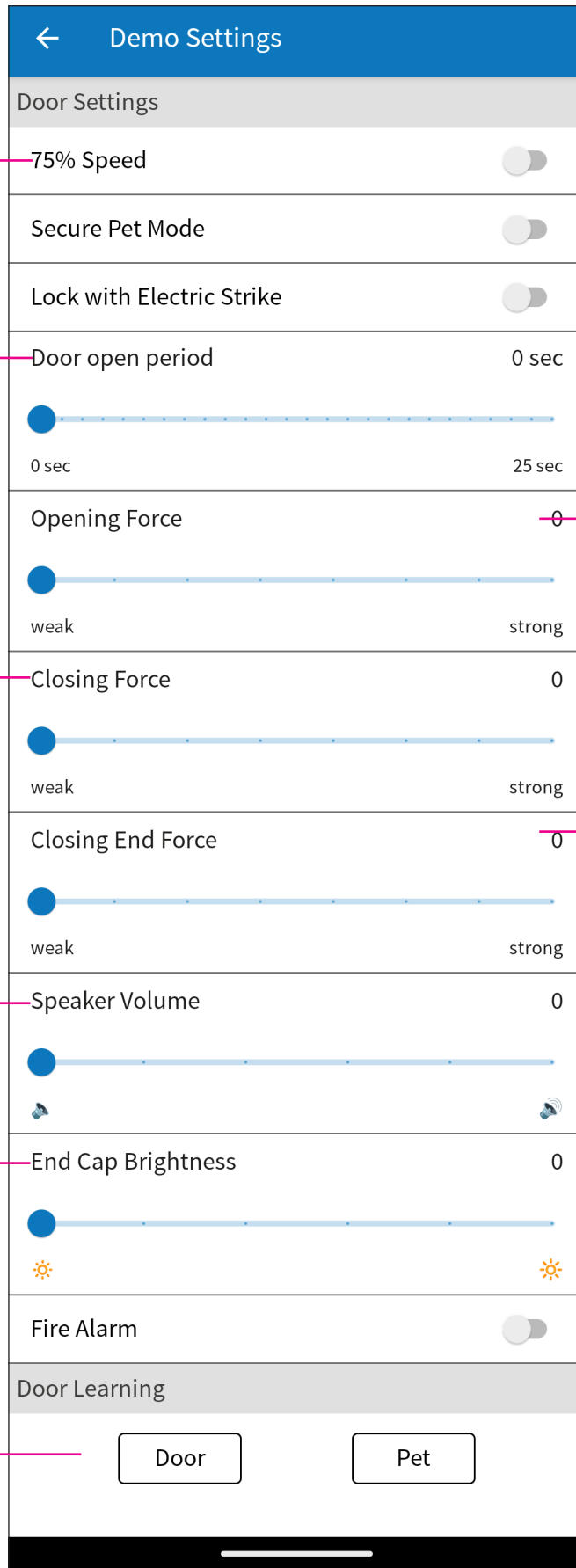

Door Opening Force. Use this slider to increase/decrease the power output of the motor during the opening of the door. This setting comes preset at three (3).

Closing End Force: This setting is to provide extra power to ensure the door engages fully into the door jamb. Most used when doors have tight jambs or high wind pressure areas. This setting comes preset at three (3).

Autoswing App Dashboard (Android Devices)

Assigned eKeys

Send eKey

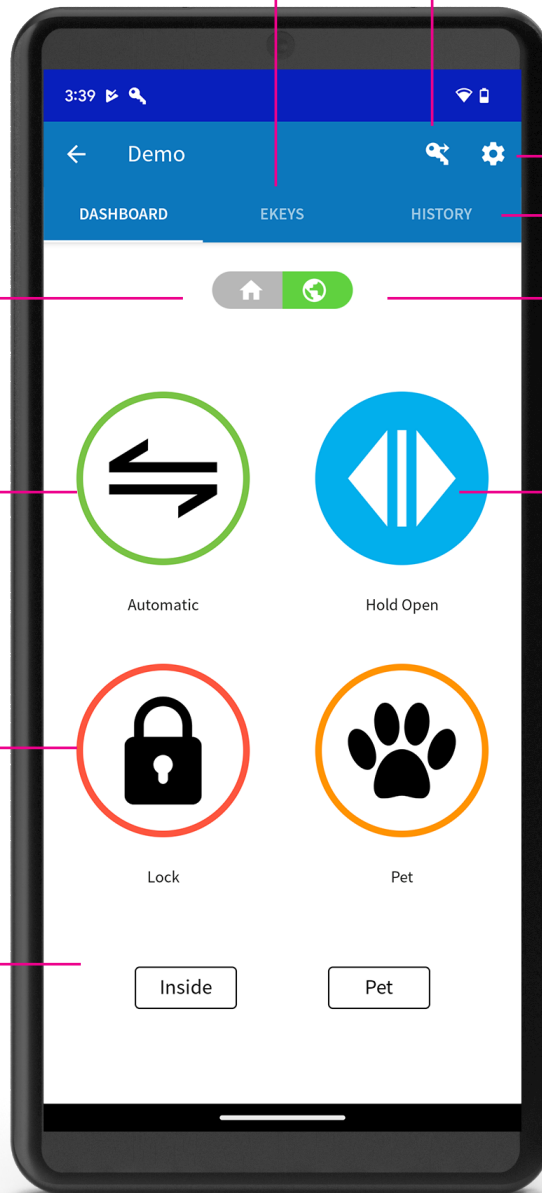

Settings

Door Log

Connect to your door via Bluetooth.

Connect to your door via the Internet.

When Automatic Mode is selected, both inside and outside sensors are active. If an electric lock is present, it will be unlocked in this mode.

Tap to keep your door open (Hold Open Mode)

When Secure Mode is selected, only the inside sensors are active and the lock will be engaged (if present).

Open the door to the full opening width.



AutoSwing Controller Layout

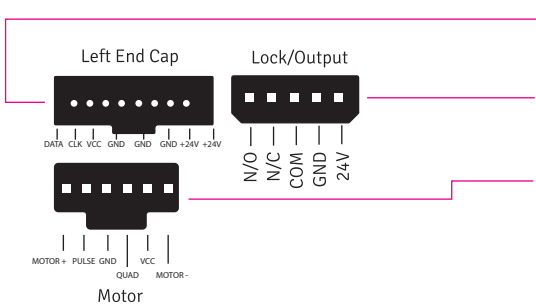
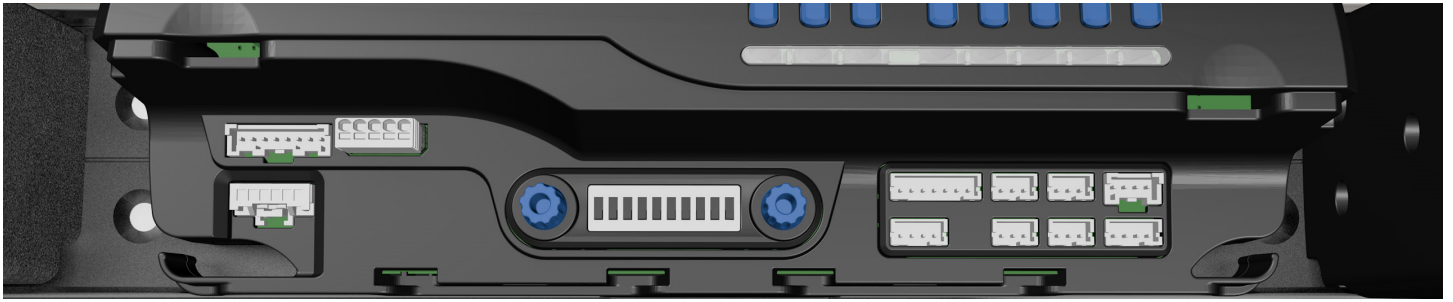

Port 1: Connects Left End Cap

Port 2: Connections for Electric Locks

Port 3: Connects AutoSwing Motor

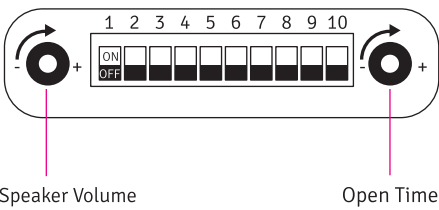

- 1 - Direction/Learn
- 2 - Slam Shut (ON)
- 3 - Electric Lock: PTO (ON)/PTL (OFF)
- 4 - Secure Pet Mode (ON)
- 5 - 75% Opening Speed (ON)
- 6 - Bluetooth App (ON)/MODBUS (OFF)
- 7 - Heavy Door (ON)/Light Door (OFF)
- 8 - Fire Alarm Acting Input Signal: 12V (ON)/0V(OFF)
- 9 - Fire Alarm Door Action: Door Open (ON)/Close (OFF)
- 10 - End Cap Light Off (OFF)

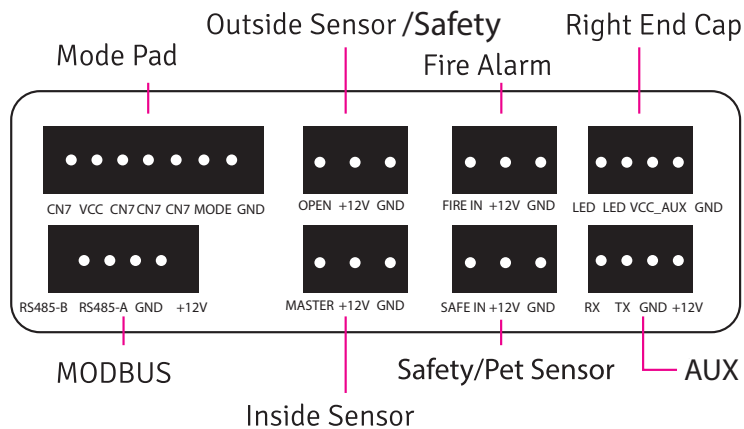

Fire Alarm Settings For Swing Door

Fire Alarm for swing door:

DIP Switch #8 for alarm input signal:

OFF: No reverse input alarm signal (normal open).

ON: Reverse input alarm signal (normal close/link to 0V).

DIP Switch #9 identifies door position when fire alarm is triggered: open or closed position.

DIP Switch #9	DIP Switch 8 (revers input signal)	Input signal from Fire Alarm	Door Action	Input signal from Fire Alarm	Door Action
Up (OFF)	Up (OFF)	0V	Open (active)	24V max	Close (normal position)
Down (ON)	Up (OFF)	0V	Close (active)	24V max	Close (normal position)
Up (OFF)	Down (ON)	0V	Close (normal position)	24V max	Open (active)
Down (ON)	Down (ON)	0V	Close (normal position)	24V max	Close (active)

Option 1: Fire Alarm Signal. Voltage will be 0V, 9V, 12V, 24Vmax

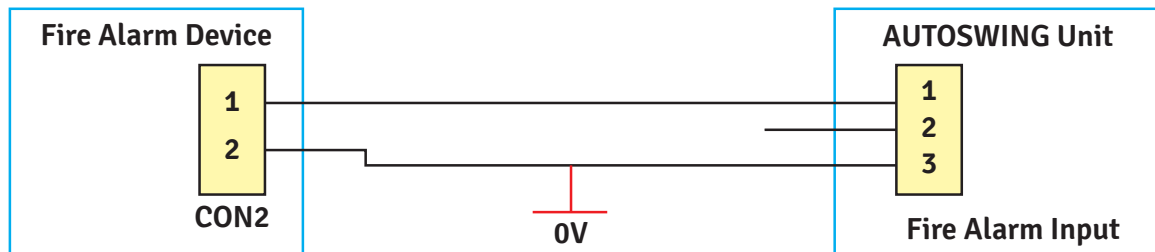

OR

Option 2: Fire Alarm Signal. Voltage will be 0V, 12V.

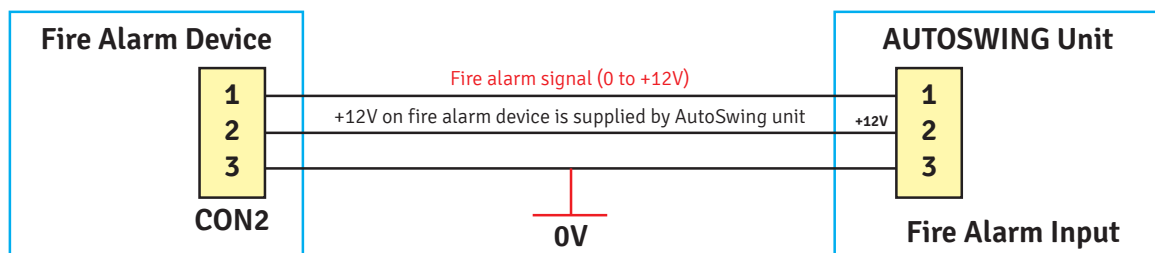

Safety Sensor



Installation of the safety sensors is required for safe operation of the AutoSwing.

The presence of safety sensors is crucial to help prevent injuries during opening and closing of the door.



Infrared Safety Sensor (Wired)

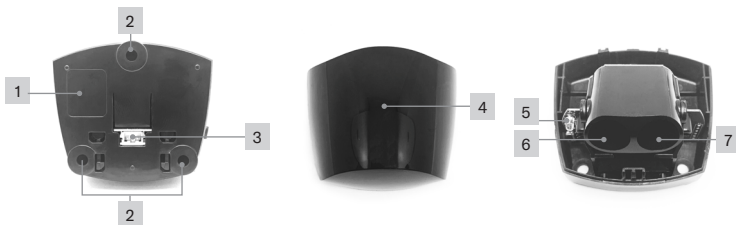

- 1- Bottom Cap
- 2- Mounting Screw Holes x 3
- 3- Sensor Back Port
- 4- Top Cover

- 5- Indicator Light
- 6- Emitter
- 7- Receiver

Infrared Safety Sensor (Wireless) - Battery Installation

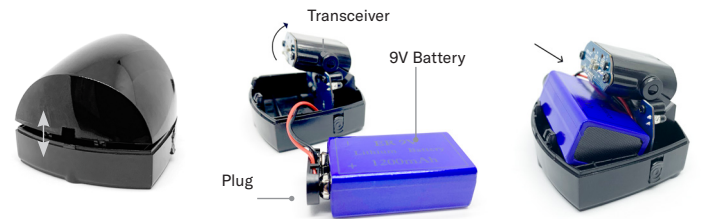

Remove the cover of the sensor to expose the board. If the battery isn't installed, rotate the transceiver down to make room for the battery. Next, connect the battery to the plug and then slide the battery into place (the red and black cables on the side should form a partial loop).

Wall Installation

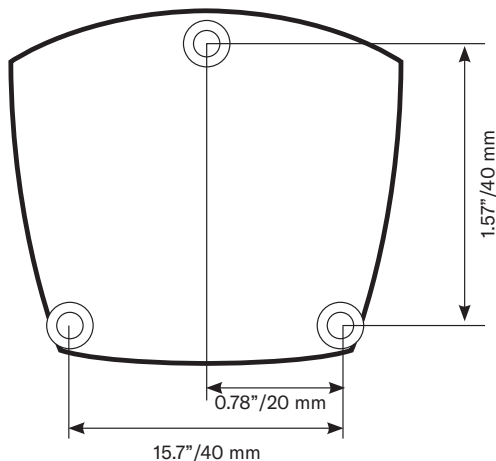

The Safety Infrared Sensors should be secured by screws or double-sided tape and mounted as follows:

- Out of direct sunlight and direct exposure to rain and snow. (Direct sunlight onto sensor can cause false activations of your door.)
- One on each side of the door to allow access from inside and outside.
- For use with people, place over the top of the door so that the beam travels vertically down the face of the door being used.

Screw Installation:

1. Remove the sensor cover to reveal the transceiver and screw holes (there is no sensitivity adjuster any longer)
2. For masonry and other hard surface applications, it may be necessary to pre-drill and install wall anchors to have a secure sensor.

Programming The Safety Sensors

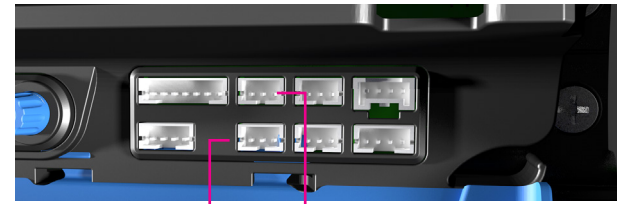
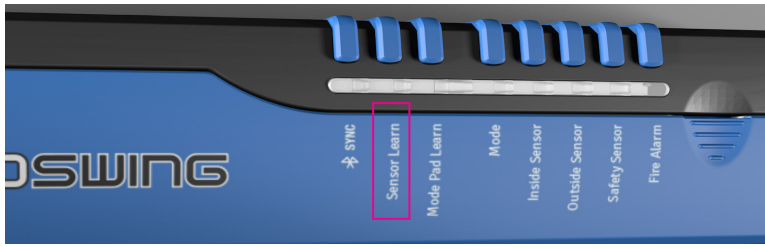

Inside Sensor Port

Outside Sensor Port

1. Remove the sensor cover and rotate the transceiver to the angle required for motion detection.
2. To program the beam length, turn the Safety Sensor power ON and position yourself at the maximum range you want the beam to shoot. The blue light will begin to flash slowly and then rapidly. Remain in the same position until the blue light goes out.
3. Test the sensor by moving in front of it. A small blue light on the sensor should illuminate when triggered.
4. Press the Sensor Learn button on the AutoSwing Controller. A green light will illuminate and remain on. Immediately trigger the sensor by moving in front of it, making sure the small green light flashes on the controller when triggered. The green light on the controller will flash three times. Trigger the sensor once more and the green light will go out. Your sensor is now programmed to the AutoSwing System.
5. To test the safety sensor, follow these steps: activate the door to open and wait until the door begins to close. Once it begins to close, break the sensor's beam path and the door should stop closing and open back to its full open position.

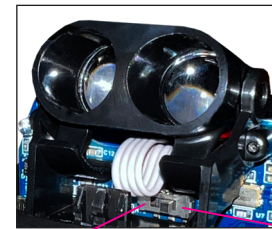
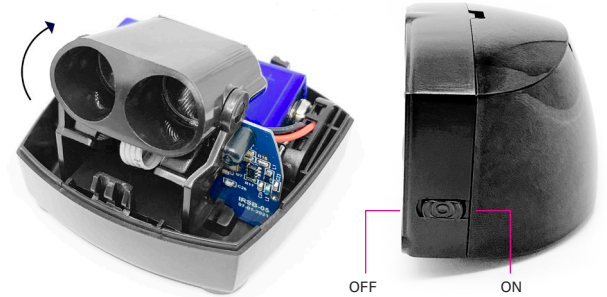

Safety Mode

Channel Switch

IR Mode

Mounting the Safety Sensor



Connect a safety sensor to the Outside Port/Channel will prevent the door from closing, or stop it while closing, when the beam path is broken.

This safety sensor should be mounted onto the door panel on the closing side of the door path.

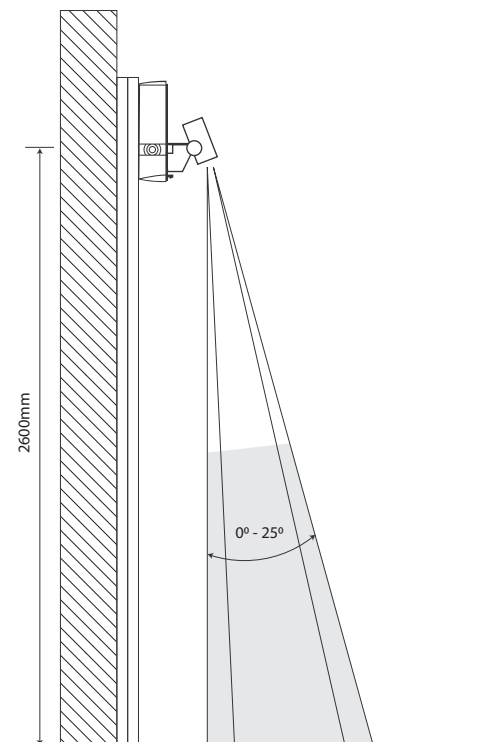

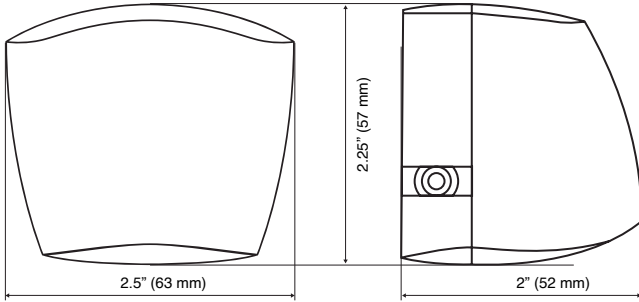

Sensor	
Dynamic Current: 13mA	Sensing method: Infrared scanning
Scanning Area: 4"x 3" (100x80 mm)	9 volt Zinc Carbon or Lithium
Frequency: 433 MHz	Wireless transmit distance: 49' (15 m)
Standby current: ≤ 80 μA	Sensing Distance: (Maximum): 6.5' (2 m)
Working temperature: -68°F + 140°F (-20°C +60°C)	Installation height: ≤102" (260 cm)
Receiver	
Power supply: AC/DC 12-36V	Quiescent dissipation: 15mA
Dynamic current: 80mA (DC 12V)	Main contact capacity: 20A 14VDC



FCC Statement

This device complies with part 15 of the FCC Rules. Operation is subject to the following two conditions:

- 1) This device may not cause harmful interference, and
- 2) This device must accept any interference received, including interference that may cause undesired operation.

Any Changes or modifications not expressly approved by the party responsible for compliance could void the user's authority to operate the equipment.

Note: This equipment has been tested and found to comply with the limits for a Class B digital device, pursuant to part 15 of the FCC Rules. These limits are designed to provide reasonable protection against harmful interference in a residential installation. This equipment generates uses and can radiate radio frequency energy and, if not installed and used in accordance with the instructions, may cause harmful interference to radio communications. However, there is no guarantee that interference will not occur in a particular installation. If this equipment does cause harmful interference to radio or television reception, which can be determined by turning the equipment off and on, the user is encouraged to try to correct the interference by one or more of the following measures:

- Reorient or relocate the receiving antenna.
- Increase the separation between the equipment and receiver.
- Connect the equipment into an outlet on a circuit different from that to which the receiver is connected.
- Consult the dealer or an experienced radio/TV technician for help.

This device complies with part 15 of the FCC Rules. Operation is subject to the following two conditions:

- 1) This device may not cause harmful interference, and
- 2) This device must accept any interference received, including interference that may cause undesired operation.

Changes or modifications not expressly approved by the party responsible for compliance could void the user's authority to operate the equipment.

NOTE: This equipment has been tested and found to comply with the limits for a Class A digital device, pursuant to part 15 of the FCC Rules. These limits are designed to provide reasonable protection against harmful interference when the equipment is operated in a commercial environment. This equipment generates, uses, and can radiate radio frequency energy and, if not installed and used in accordance with the instruction manual, may cause harmful interference to radio communications. Operation of this equipment in a residential area is likely to cause harmful interference in which case the user will be required to correct the interference at his own expense.

1 Connect the antenna to the back of the AutoPlus and tighten by turning clockwise. Position the antenna to a straight up position.

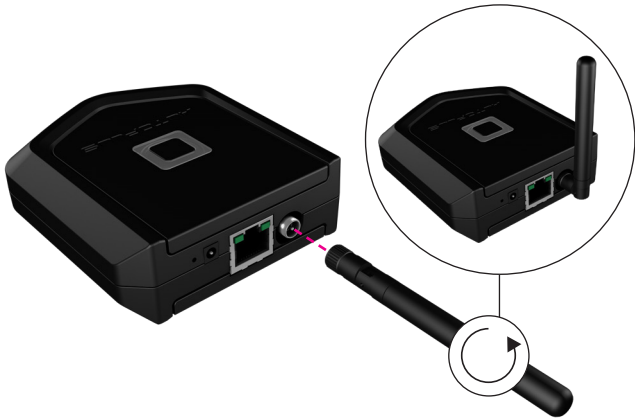

2 Plug the Ethernet cord into your router and connect the other end to the back of the AutoPlus.



3 Connect the power cable to the AutoPlus and plug the power supply into a working outlet.



4 AutoPlus LED light will start flashing ready to pair with Autoslide App.



5 Check these before beginning the pairing process for AutoPlus:

- An AutoSwing has been installed and paired successfully to your account with an admin owner eKey.
- AutoPlus is powered ON and connected to a live internet connection. The AutoPlus should be pulsing a white light when it is ready to begin the pairing process.
- Latest version of the Autoslide App is downloaded and installed on your phone.
- AutoPlus is connected to the router and a live internet connection.

6 After configuration, control your doors with the Autoslide App.

To verify your AutoPlus has properly paired and connected to your account, locate the AutoPlus and verify you have a solid blue light. This indicates a successful pairing to your account and that it has located your AutoSwing system.

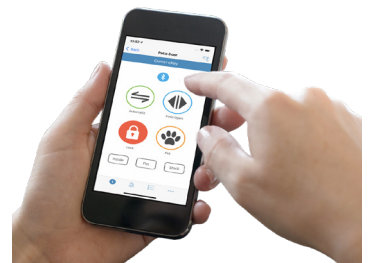

Color	Meaning
White (solid)	Starting up
White (fade in and out)	Ready to pair
Blue	Normal operation
Amber (blinking)	Factory reset
Red	Not connected to internet
Magenta	Searching for Automatic Door
Amber (fade in, fade out)	Firmware download in progress
Amber (rapid blinking)	Updating firmware

Reset the AutoPlus

Reset your AutoPlus Gateway by gently inserting a paper-clip into the pinhole on the back of the unit. This will change the LED status to blue and then back to white.

The LED will briefly flash amber while the AutoPlus is resetting and rebooting.



Safety instructions

This document contains important instructions for installation of AutoSwing door operators.

Review these instructions thoroughly prior to installation, and follow them carefully during installation, commissioning, troubleshooting and maintenance.

When DIP Switch #7 is ON or if any force setting in the app is set higher than three (3), two safety sensors are required to be installed, with one on the opening side and one on the closing side of the door..

All low energy doors

Automatic Caution Door Decal

- All low energy doors shall be marked with signage visible from both sides of the door with the words “CAUTION: AUTOMATIC DOOR.” This is required in commercial applications. For residential applications, it is recommended but not required..
- Signs shall be mounted 50 inches +/- 12 inches from the floor to the centre line of sign.
- Door must be activated by knowing act. A knowing act is any conscious action with the expected result of opening a door.
- ACTIVATE SWITCH TO OPERATE decal
- When a knowing act device is used to initiate the operation of the door operator, the door shall be provided with a sign on each side of the door where a switch is operated with the message “ACTIVATE SWITCH TO OPERATE.
- Push/Pull used to initiate door operation.

When connecting a powered door operator to a source of power, the installation personnel must be cautious and be warned/aware of the risks associated with allowing the cord to become entrapped in moving parts of the operator, door, or system.

Note the cord should not be :

Routed through doorways, window openings, walls , ceilings, floors or the like;

Attached or otherwise secured to the building structure;

Concealed behind walls and the like.

Detachable Power Supply Cord Marking: “WARNING: USE ONLY ADAPTOR PROVIDED FOR USE WITH OPERATOR, OTHER ADAPTOR MAY RESULT IN RISK OF FIRE. SEE INSTALLATION INSTRUCTIONS FOR DETAILS” or equivalent.

Manufacturer’s Name AUTOSLIDE PTY LTD

Trademark AUTOSWING

Catalogue number ASW8-1

Power Supply Adaptor Input voltage: 100VAC-240VAC,2.5A , 50Hz, 60Hz

Output voltage : 25VDC , 2.6A



Safety warnings

WARNING

An incorrect installation may result in damage to equipment or incorrect equipment operation



WARNING

Electric shock hazard!
By use of control elements, settings, or procedures not documented in this manual!



WARNING

Work on electrical equipment and 115 Vac wiring installation must be only be performed by qualified personnel!



WARNING

Metallic doors must be grounded per national and local codes!



WARNING

- When dip 7 (light/heavy) setting is on, or dip 2 (slam shut) setting is on . the system need add safety sensor to avoid hit people or pet heavily due to heavy force. Also dip 5 (75% opening speed) is off, safety sensors must be present. According to Australian standard (AS5007-2007 power doors for pedestrian access and egress) .
- When the door open force Max , closing force Max, closing end force Max setting is over level 4 by AutoSwing App , system needs safety sensor .



WARNING

Hand pinch point and crushing hazards at door closing edges!



Opposing closing edge Main closing edge



WARNING

Crushing hazards at door closing edges!



WARNING

Hand pinch point and crushing hazards at arm and track!



FCC Statement

This device complies with part 15 of the FCC Rules. Operation is subject to the following two conditions:

- (1) This device may not cause harmful interference, and
- (2) This device must accept any interference received, including interference that may cause undesired operation.

Any Changes or modifications not expressly approved by the party responsible for compliance could void the user's authority to operate the equipment.

Note: This equipment has been tested and found to comply with the limits for a Class B digital device, pursuant to part 15 of the FCC Rules. These limits are designed to provide reasonable protection against harmful interference in a residential installation. This equipment generates uses and can radiate radio frequency energy and, if not installed and used in accordance with the instructions, may cause harmful interference to radio communications. However, there is no guarantee that interference will not occur in a particular installation. If this equipment does cause harmful interference to radio or television reception, which can be determined by turning the equipment off and on, the user is encouraged to try to correct the interference by one or more of the following measures:

- Reorient or relocate the receiving antenna.
- Increase the separation between the equipment and receiver.
- Connect the equipment into an outlet on a circuit different from that to which the receiver is connected.
- Consult the dealer or an experienced radio/TV technician for help.





MURPHY DOOR