



MURPHY DOOR®

Flush Mount Door - unassembled



BILT
3D interactive instructions



murphydoor.com | 888.458.5911

PLEASE READ INSTRUCTIONS FULLY BEFORE YOU BEGIN ASSEMBLY

01

Before you start

- If you are not installing door on receipt keep it standing level on its base or lay it flat. **DO NOT** lean it against a wall on its edge.
- Proper moving - **Murphy Door is not responsible for dropped door damage.**
 - Take door/cabinet out of jamb and carry cabinet and jamb separately.
 - **DO NOT** carry or lift by face frame.
 - The doors are heavy, handle with care.
 - Support the entire door when carrying and lifting the door.
 - Minimum of two persons recommended.
- Make sure all instructions are read and understood by installer prior to installing your door. Our doors are unique and have particular finishing details.
 - The cabinet is 1-1/2" to 2" narrower than the jamb. This allows for proper function of the door. Gaps will be covered by finish casing.
 - In-swing and out-swing casing and hinges are placed differently.
 - There will be some wall finishing needed where the wall meets the jamb. For best results prep the wall with the sheet rock edge cut as straight and clean as possible.
- Verify that you have all parts prior to starting the installation or hiring a contractor.
- Test your pin to make sure it works properly.
 - Hold the pin while pushing the center button. The two ball bearings should retract slightly. If the ball bearings do not retract spray with dry lube. Engage the center button several times. Recheck to see if pin is working properly. **DO NOT use if pin isn't working properly.**

02

Painting and staining

- If you are finishing your door (paint or stain) we encourage you to do so within 10 days to seal the wood. This will help minimize climate differences. Murphy Door can not offer a warranty against sagging or warping on unfinished doors.
- Use care when applying. Keep pre-drilled holes free of excess paint or stain to make assembly easier.
- **DO NOT** use water-based paints. Commercial grade furniture paints and stains are required.
- Always do a sample test with your paint or stain. The sides of the jamb that will be placed against the wall are great places to test as they will not be seen once the door is installed.
- Always read and follow the paint or stain instructions before applying to the door.

03

Installation tips

- **Framing**
 - Rough opening should be framed with 2" x 4" or 2" x 6" studs.
 - If using metal studs, replace the included 3" screws with (8) 3" self-tapping screws.
 - Make sure your studs are parallel - measure top, middle, and bottom of the jamb RO) and square by putting a square in all four corners. If they are not, your Murphy Door will not function properly and may appear bowed.
- **Threshold**
 - For best results install the door on a level surface. **DO NOT** install the bottom threshold over carpeting. Carpet will affect levelling and prevents proper function of the door.
 - If you must shim the threshold, it is best to have a shim that is the width of the threshold and runs the entire length of space needed to shim.
- **Jamb**
 - **DO NOT** over or under tighten jamb. When installing the jamb you need to make sure it is shimmed properly. It should be level and square with the threshold and header. If the jamb is not square it may cause your door to function improperly or appear to sag.
- **Hinge Pin Installation**
 - On out-swing doors make sure the pin goes up through the hole in the top of the door and through both hinges. **DO NOT** put the pin in from the top down. If properly installed the pin will countersink and the button will be fully extended (not depressed). If it protrudes below the header it is not properly seated and may fail causing the door to fall out. **BE CERTAIN** that the hinge pin is seated and goes through both hinges.

PLEASE READ INSTRUCTIONS FULLY BEFORE YOU BEGIN ASSEMBLY

• **Out-swing Door**

- For the best results cut the sheet rock edge as straight and clean as possible on the non hinge installation side; left edge for a right out-swing, right edge for a left out-swing. Install the jamb tight to prepped edge.

Shim the hinge edge as needed. This will make for less finish work.

• **Casing** (aka Trim)

- Make sure your door opens, closes, and swings properly prior to installing the casing.
- Attach vertical casing first, then top casing. This will make it easier to visually center the top casing.
- The MD casing is designed so the top casing goes past the side casings 1-1/2" per side.

• **Finishing**

- Make sure your door works properly before you finish the wall.
- Caulk, mud, or tape to finish the edge where the wall meets the jamb.

04

Troubleshooting

My out-swing door protrudes at the top or swings open on its own?

- Move the jamb on lower hinge side out 1/2 the pop distance. If the pop out is 1/2", moving the jamb 1/4" out will fix 99% of all issues. Home construction is seldom square and plumb and may sometimes make our doors appear not to be.
- Ensure that the wall, door and casing are level.
- Make sure that corners in jamb are square.
- Make certain that the hinges are plumb, aligned top and bottom.
- Lay door on flat surface and use straight edge to make sure that the door is not bowed, swelled or over sanded. Use the longest straight edge possible, 4'-6', to get the most accurate results. The straight edge must be a manufactured level, square, or similar tool.
- Check casing and door to see if one is bowed.

My door sags on the non-hinge side?

- Make sure floor is level.
- Check door to make sure wood is level and unbowed.
- Check jamb to make sure it square and level, not over or under tightened.
- Check friction catch measurements.

My hinge pin will not go in the hinge?

- Sand the hole - paint over spray may be hindering seating.
- Take pressure off the door.
- Spray with dry lube. Ball bearings failing to retract may prevent seating.
- If the pin will not go in, **DO NOT** use a tool to tap it in. This will damage the pin and make it harder to get out.
- If the above steps have been taken and you still cannot get the pin in, check your jamb and door to be sure they are plumb and level.

05

1 Year Warranty (U.S.A. only)

Murphy Door warrants your door against defects in material and workmanship under normal use and maintenance for a period of one (1) year from the date of original purchase.

Murphy Door Inc. will provide a replacement part for any part found to be defective. Original part(s) approved for return by Murphy Doors customer service department must be returned prepaid. This warranty does not include labor charges connected with the determination or replacement of defective parts, or freight charges to ship these parts.

Murphy Door Inc. shall not be liable under this or any implied warranty for incidental or consequential damages. This warranty gives the retail customer specific legal rights and the customer may have other rights which vary from state to state.

This warranty shall be void if the unit is not assembled or operated in accordance with the operation instructions provided with this unit; the unit is re-sold or traded to another owner; components, accessories; or the user has abused or otherwise failed to maintain the unit.

To process a warranty claim, Murphy Door requires you to register your product on our BILT app and proof of your date of purchase. You should retain your sales slip or invoice with your valuable documents.

PLEASE READ INSTRUCTIONS FULLY BEFORE YOU BEGIN ASSEMBLY

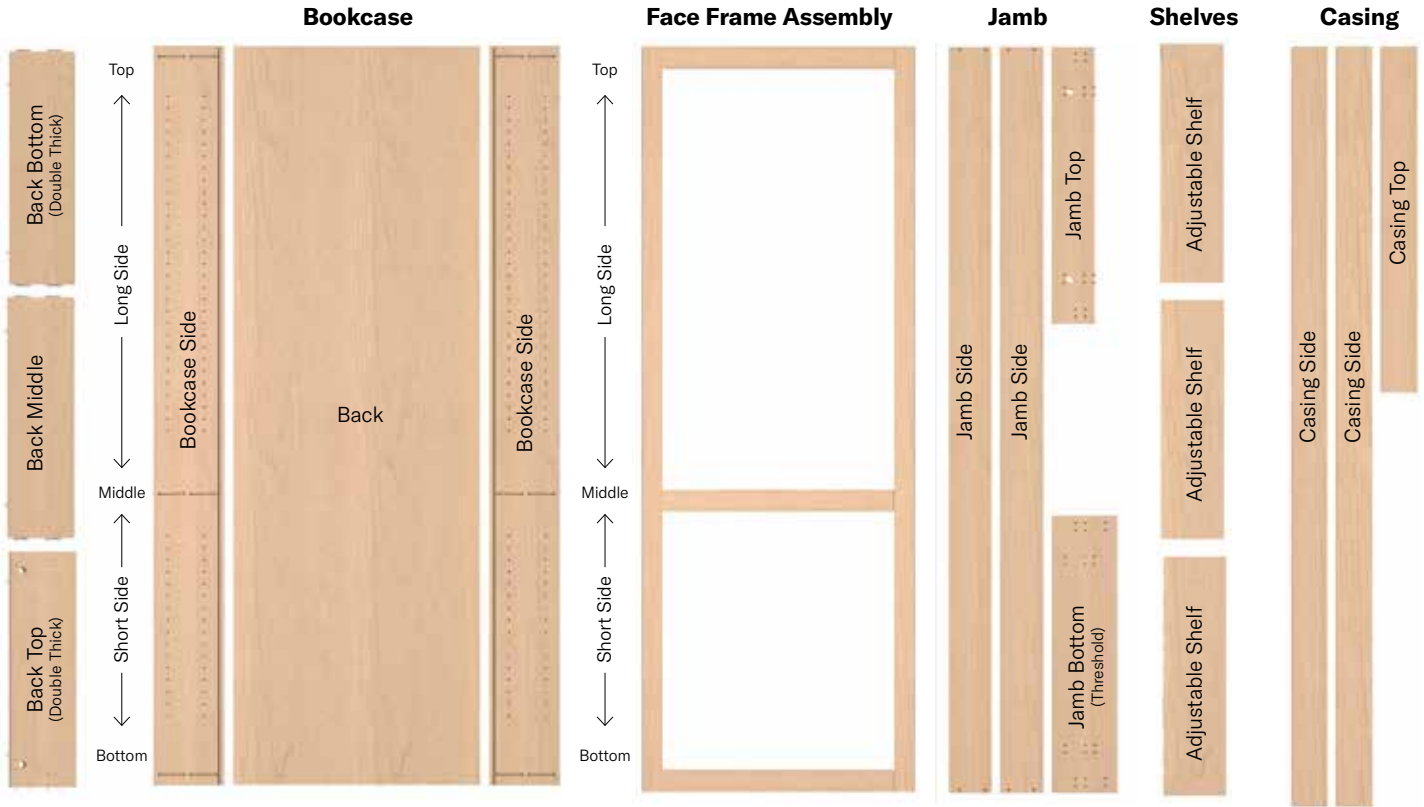

To assemble the door you will need:

- Tape Measure
- Drill
- Countersink Bit
- Phillips Head Bit
- 1/8" Drill Bit
- Square Head Drill Bit (included)
- Adjustable Wrench
- Hammer/Brad Nailer
- Finish Nails
- Carpenters Square
- 2' and 6' Level
- Rubber Mallet
- Wood Glue
- (6) Wood Clamps
- (2) Saw Horses

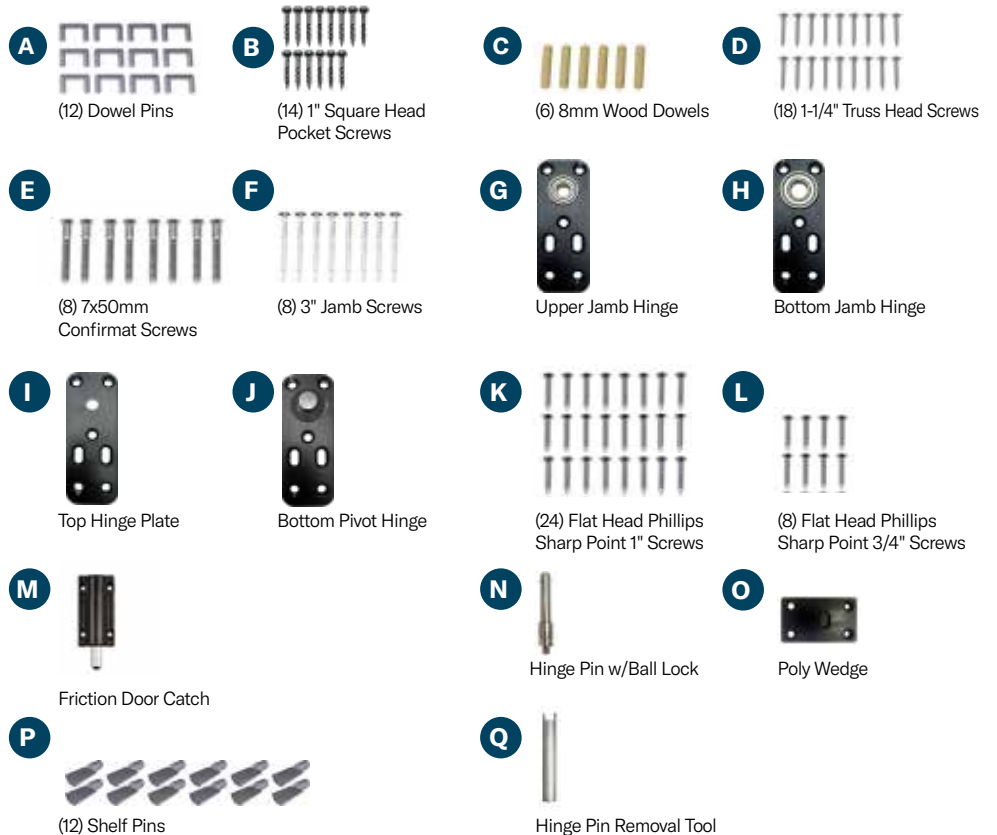

PLEASE READ INSTRUCTIONS FULLY BEFORE YOU BEGIN ASSEMBLY



Insert (4) dowel pins (A) all the way into the back top, back middle, and back bottom. Some splitting may occur but will not effect the performance or appearance of the door.

Note: The top and bottom bookshelf pieces are double thickness, the middle bookshelf piece is a standard single thickness.



Insert (4) dowel pins (A) into the back middle and (4) dowel pins (A) into the back bottom. Note the orientation of the dowel holes and pins and align the boards as shown. Flip all boards over so that the dowel holes are facing down.



Attach the back top to the right bookcase side by placing the dowel pins into the dowel pin joints and sliding down. Note the dowel hole and pilot hole orientation. Continue placing the back middle and back bottom noting dowel hole orientation.

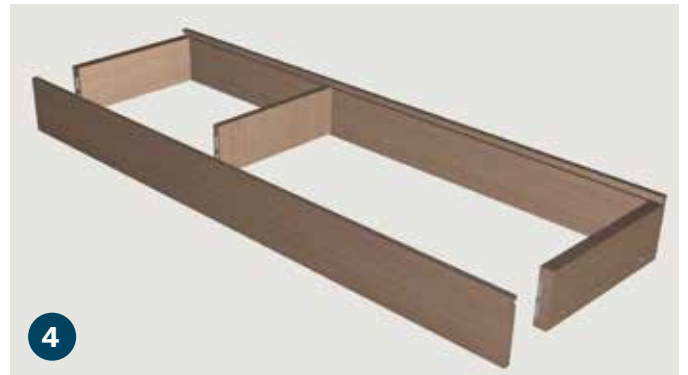

Attach the back bottom, back middle, and back top to the left bookcase side by placing the dowel pins into the dowel pin joints and sliding down. Note the pilot hole orientation.

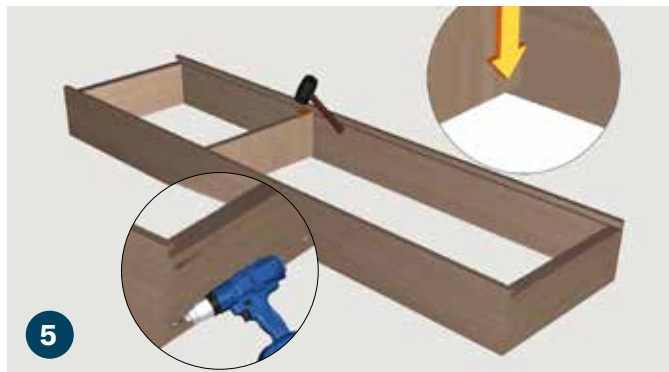

Using a rubber mallet make sure the back middle, back top, and back bottom are flush and even with the front of the bookcase sides. To avoid damage it is best to use a piece of scrap wood when using the rubber mallet. Once flush, re-enforce the corners with (8) 1" square head pocket screws (B).



To install the front face frame turn the bookcase over. Add a small amount of wood glue to the dowel holes on the face frame assembly and insert (6) wooden dowels (C).

PLEASE READ INSTRUCTIONS FULLY BEFORE YOU BEGIN ASSEMBLY

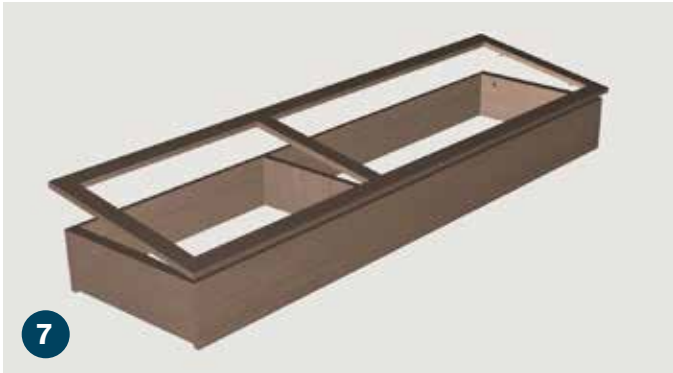

Dry fit the face frame onto the bookcase to ensure that the dowel holes align properly.

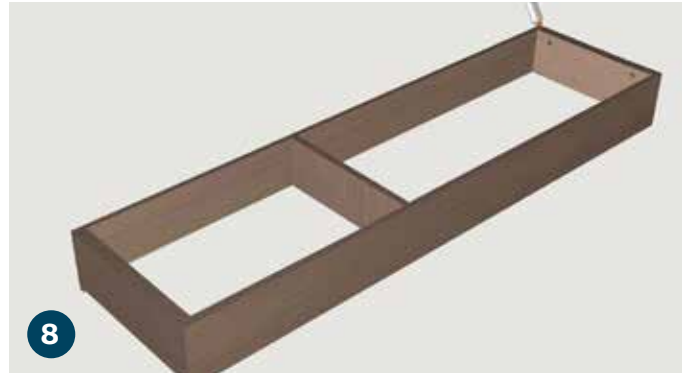

Add a small amount of wood glue into the dowel holes of the bookcase. Next apply wood glue to the perimeter of the bookcase.

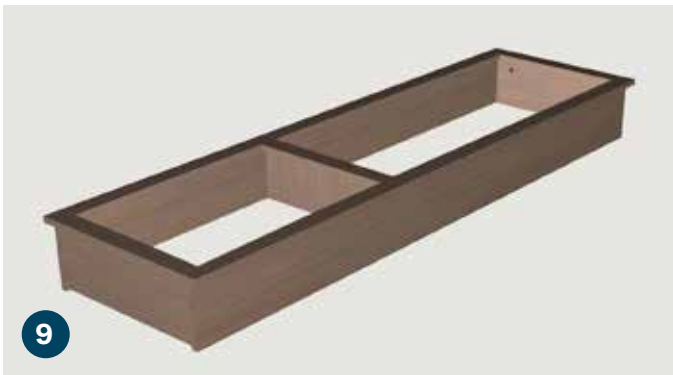

Firmly press the face frame assembly onto the bookcase, aligning the dowels and dowel holes.



Place the bookcase onto saw horses, a work bench, or table. Place (6) wood clamps on the corners and the middle of the bookcase to secure the face frame while the glue dries.

Note: Although not required, you may use a brad nailer in addition to the glue to help secure the face frame.

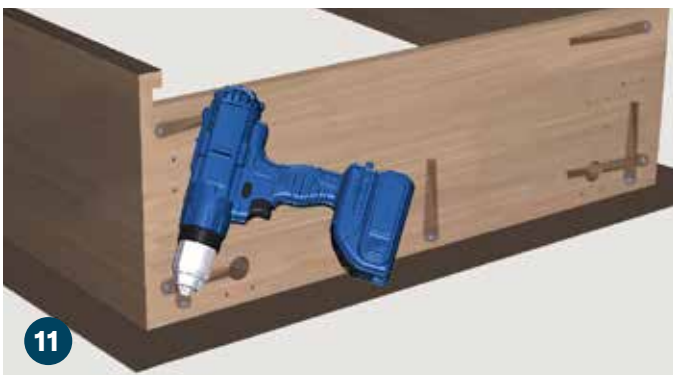

Remove wood clamps and flip the assembly over. Reinforce the top and bottom face frame with (6) 1" square head pocket screws (B).

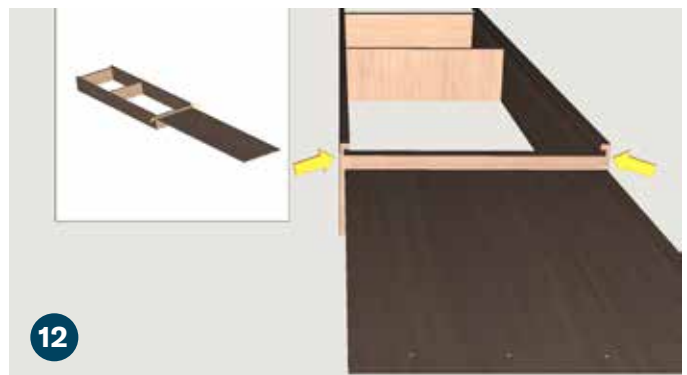

With the help of another adult, gently slide the back into the assembly. Make certain the back is sliding in straight to prevent it getting wedged.

PLEASE READ INSTRUCTIONS FULLY BEFORE YOU BEGIN ASSEMBLY



13
Ensure that the back is flush with the tops of the bookcase sides and that the bookcase is square. The pre-drilled holes on the back should align with the back bottom, back middle, and back top.

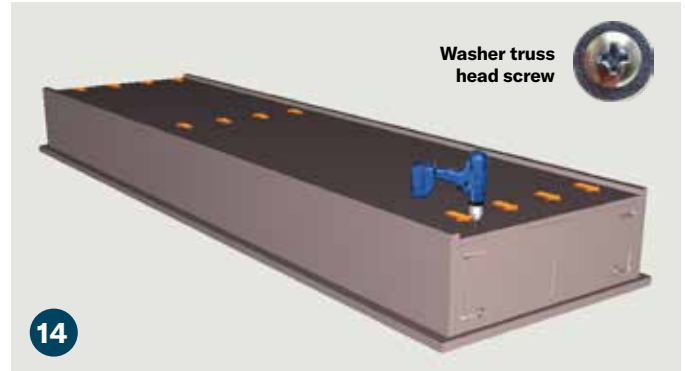

14
Using the back as a template, drill pilot holes in the back top, back middle, and back bottom using a 1/8" drill bit. This will prevent damaging or splitting the wood. Attach the back to the back top, back middle, and back bottom using (12) 1-1/4" washer truss head screws (D).

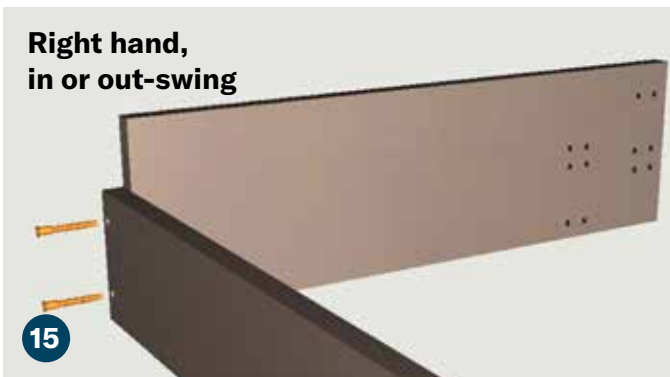

15
Right hand, in or out-swing
Align the jamb bottom threshold and 1 jamb side on a flat surface. The pre drilled hinge holes on the jamb bottom threshold will be on the right for a right hand in or out-swing, on the left for a left hand in or out-swing. After ensuring the corner is square; install (2) 7 x 50mm confirmat screws (E).

NOTE: Jambs deeper than 4-9/16" will require additional screws

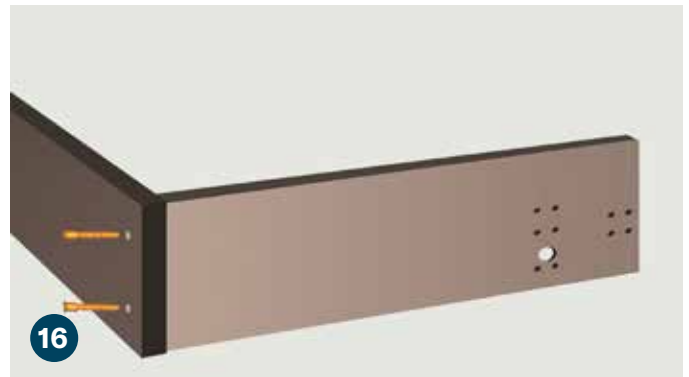

16
Position the jamb top making certain that the pre-drilled hinge holes are on the same side as jamb bottom hinge holes. After ensuring the corner is square; install (2) 7 x 50mm confirmat screws (E). Secure the remaining side jamb, making certain all corners are square, with (4) 7 x 50mm confirmat screws (E).



17
Place the door jamb into the rough opening. The bottom jamb threshold should extend into the room toward the back of the bookcase.



18
It is critical that the bottom threshold and jamb sides are level. If the door jamb is not level and plumb the door will not swing and close properly.

Note: The bottom threshold **SHOULD NOT** be installed over carpeting. Carpet will affect levelling and prevents proper function of the door.

PLEASE READ INSTRUCTIONS FULLY BEFORE YOU BEGIN ASSEMBLY

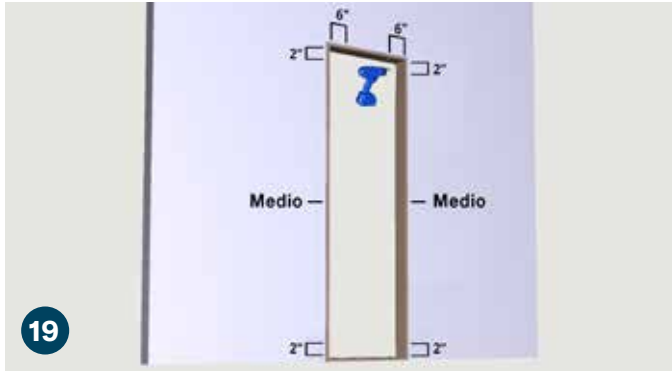

Using a 1/8" drill bit pre-drill and countersink three holes into each side of the door jamb 2" from the top of the jamb, 2" from the bottom of the jamb, and in the middle. Next pre-drill and countersink two holes into the jamb top 6" from the right and left sides of the jamb.

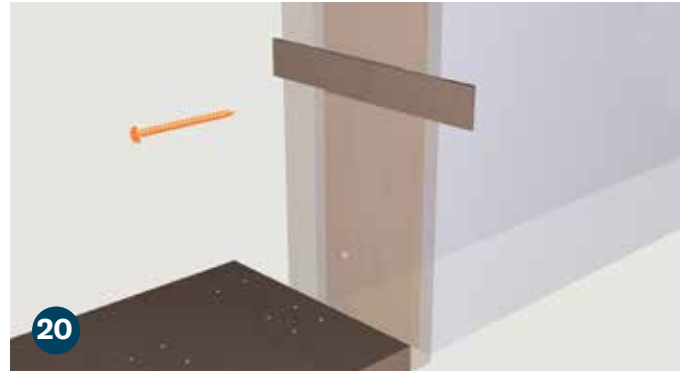

Using shims where needed, install (8) 3" jamb screws (F) making certain the top and sides of jamb are level.

Note: The screws included are meant for a wood frame. If installing the jamb into a steel frame, replace the screws with (8) 3" self-tapping screws.



To install a right hand, in-swing door attach the upper jamb hinge (G) to the jamb top using (4) flat head Phillips sharp point 1" screws (K), lining up the hinge as shown.

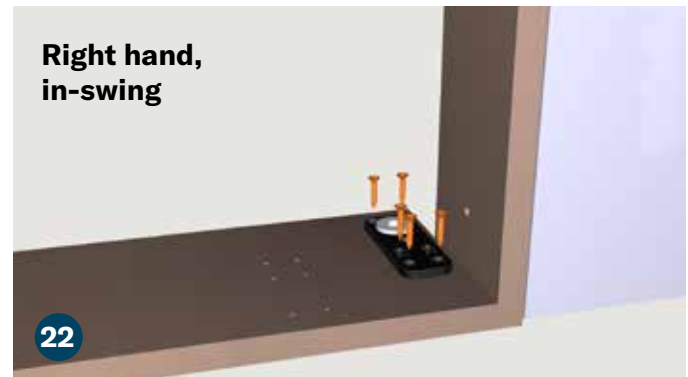

Install the bottom jamb hinge (H) to the jamb threshold using (5) flat head Phillips sharp point 1" screws (K), lining up the hinge as shown.

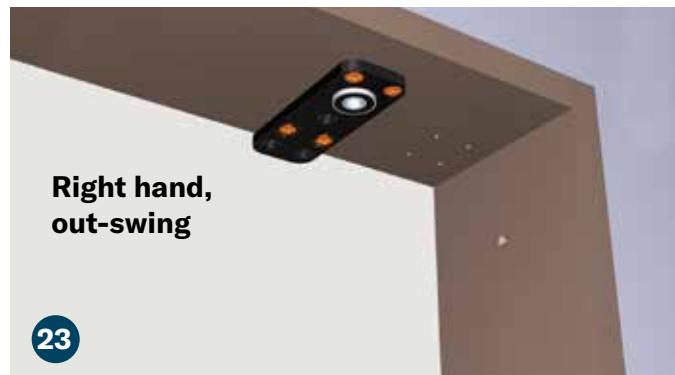

For a right-hand, out-swing door attach the upper jamb hinge (G) to the jamb top using (4) flat head Phillips sharp point 1" screws (K), lining up the hinge as shown. Make sure that you only use four screws. **DO NOT** drill into the two holes closest to the edge of the jamb as this can split your edge.

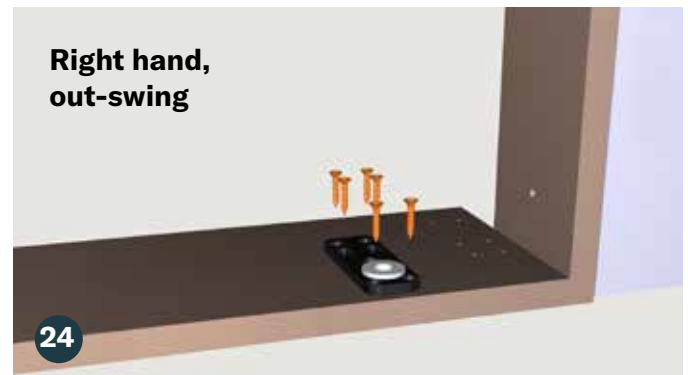

Install the bottom jamb hinge (H) to the jamb threshold using (6) flat head Phillips sharp point 1" screws (K), lining up the hinge as shown.

PLEASE READ INSTRUCTIONS FULLY BEFORE YOU BEGIN ASSEMBLY

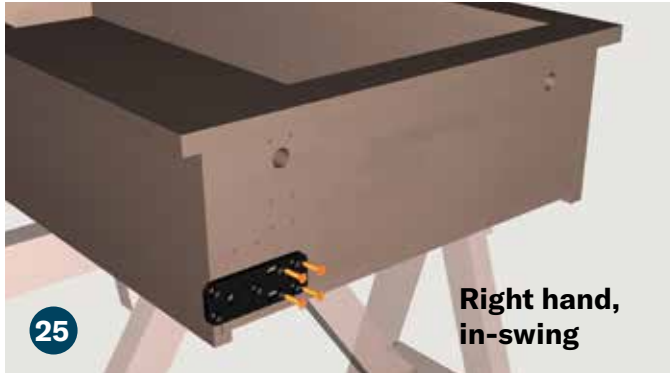

**Right hand,
in-swing**

For a right hand, in-swing door line up the hinge as shown. Attach the top hinge plate (I) to the top bookcase assembly using (4) flat head Phillips sharp point 1" screws (K).

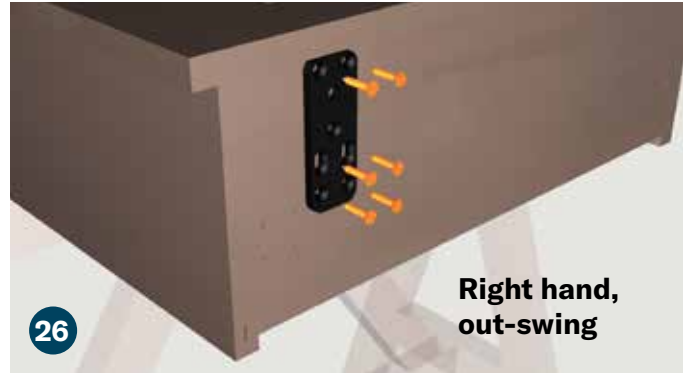

**Right hand,
out-swing**

For a right hand, out-swing door line up the hinge as shown. Attach the top hinge plate (I) to the top bookcase assembly using (6) flat head Phillips sharp point 1" screws (K).



**Right hand,
in-swing**

Match the bottom pivot hinge (J) to the pre-drilled holes at the bottom of the bookcase assembly as shown. With the plate lined up attach using (4) flat head Phillips sharp point 1" screws (K).



**Right hand,
out-swing**

Match the bottom pivot hinge (J) to the pre-drilled holes at the bottom of the bookcase assembly as shown. With the plate lined up attach using (6) flat head Phillips sharp point 1" screws (K).



2-1/2"

29

The friction door catch installs on the door side opposite the hinge. Make a mark 2-1/2" from the back of the door's face frame.



2-1/2"

30

Position the friction door catch (M) at this mark, flush to the door bottom. Secure using (4) flat head Phillips sharp point 3/4" screws (L).

PLEASE READ INSTRUCTIONS FULLY BEFORE YOU BEGIN ASSEMBLY

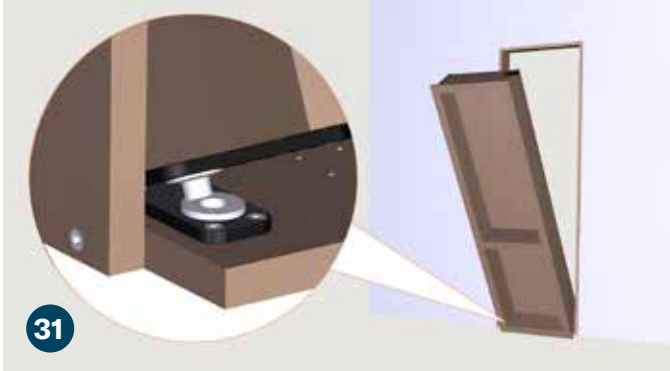

Place the door into the door jamb. Make sure the bottom hinge sits in the silver thrust bearing.



Press down on the ball lock of the hinge pin (N) to retract the two top pins.



For an in-swing door align the holes of the bookcase top jamb hinge with the holes of the top door hinge. Depress the hinge pin button and insert the hinge pin into the holes making certain the pin locks into place.

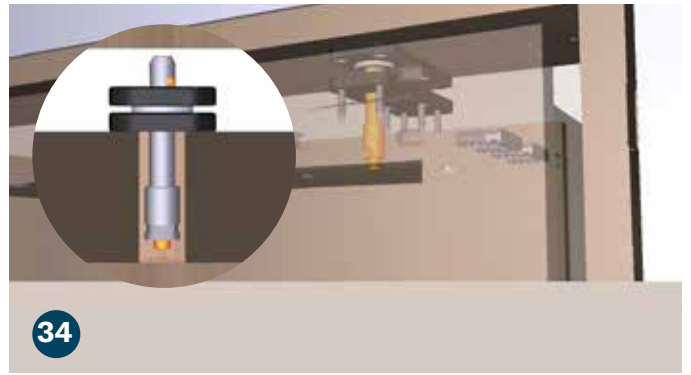

For an out-swing door the hinge pin inserts from the front side of the bookcase. Align the hole in the top of the bookcase with the top door hinge. Depress the hinge pin button and insert the hinge pin. The hinge pin will appear countersunk when properly installed and locked into place.

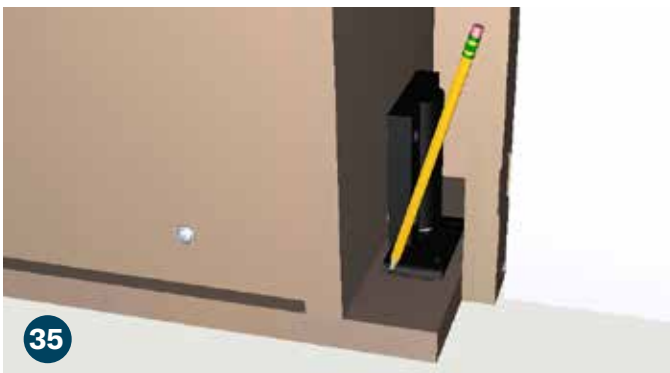

Place the poly wedge (O) where the doorstop carriage bolt will go when the door is closed. Ensure that the door is flush. Mark out the poly wedge location with a pencil or tape.

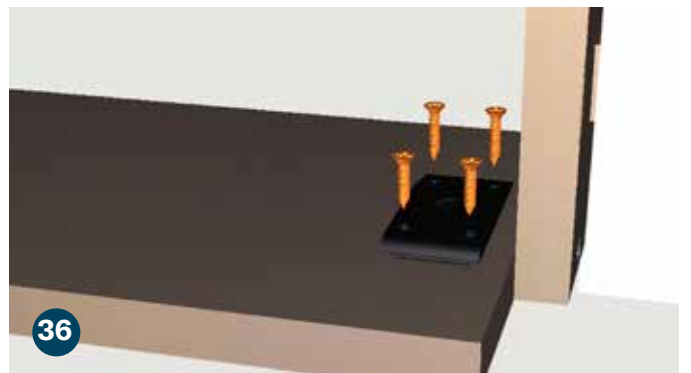

Remove the sticker from the back of the poly wedge placing it over the marked location. The wedge taper should face in for an in-swing door and out for an out-swing door. Secure with (4) flat head Phillips sharp point 3/4" screws (L).

PLEASE READ INSTRUCTIONS FULLY BEFORE YOU BEGIN ASSEMBLY



Now that the door assembly is in place use an adjustable wrench to tighten the carriage bolt just enough to catch the door catch.

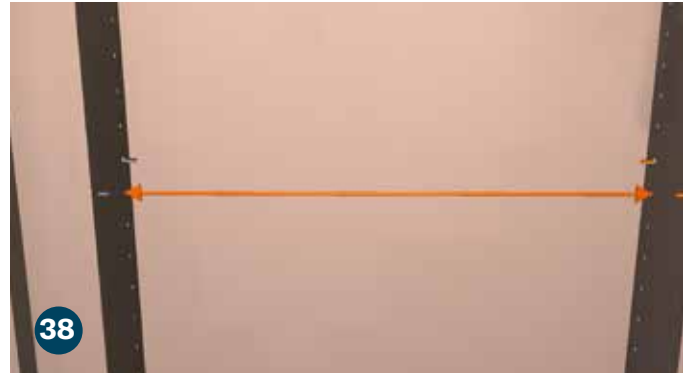

Add (2) shelf pins (P) where desired and (2) shelf pins (P) directly across from the first two.

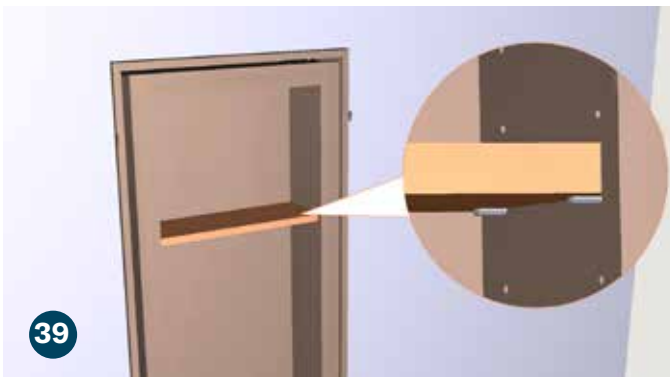

Slide the shelf into place onto the installed shelf pins. Do the same for the remaining shelves as desired.

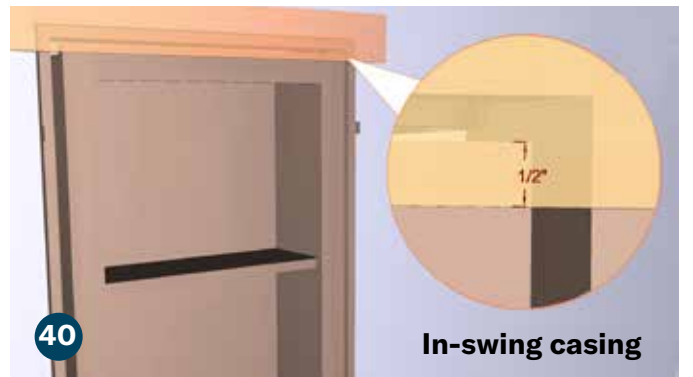

For an in-swing door, position the top casing with a 1/2" overhang on the face frame of your door. Attach using a brad nailer.

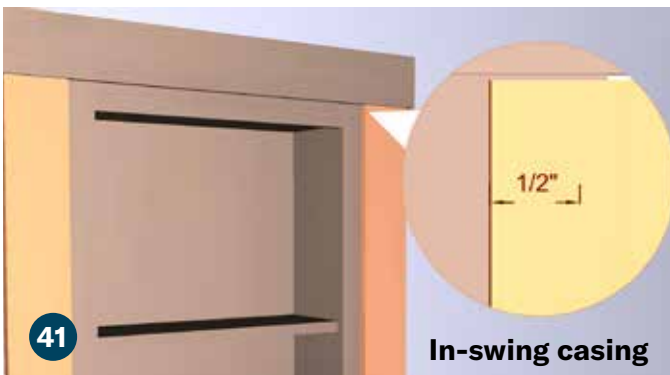

Position the right and left side casings with a 1/2" overhang on the face frame of the door. Attach using a brad nailer.

*Due to variances in home construction, cutting the side casing may be necessary. We recommend cutting the bottom edge for the most professional finish. Alternatively, you may install the uncut side casings first and then the top casing.

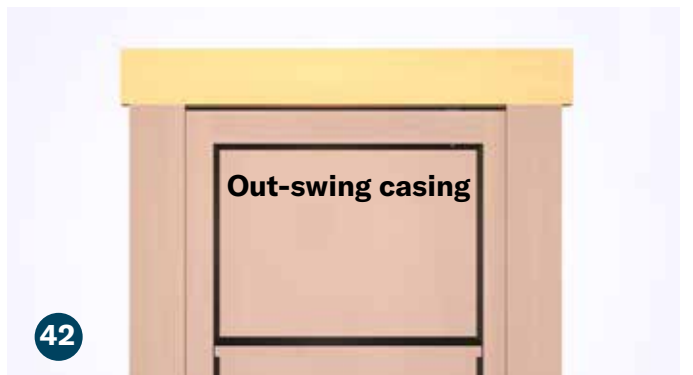

For an out-swing door, center the top casing over the door leaving a 1/16" clearance over the door itself. Attach using a brad nailer.

PLEASE READ INSTRUCTIONS FULLY BEFORE YOU BEGIN ASSEMBLY



Trim the right and left casing to fit as needed. Attach the right casing onto the door jamb with a 1/2" overhang on the door face frame.

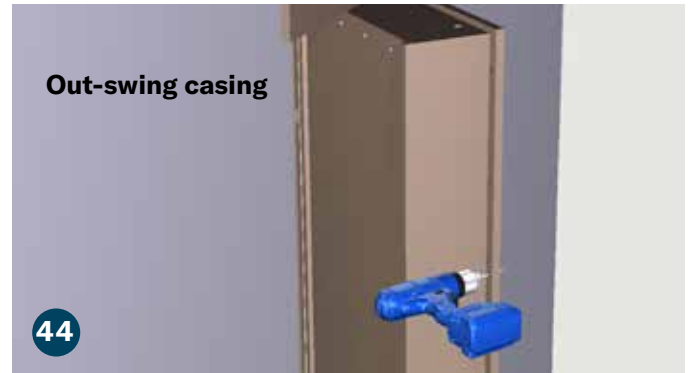

Using a 1/8" drill bit pre-drill and countersink five holes into the left support face frame. This will make it easier to attach the left side casing.



Run a bead of glue down the face frame of the door to strengthen the left casing.



Position the left side casing. Test the door swing prior to screwing in to ensure it doesn't make contact with the floor.

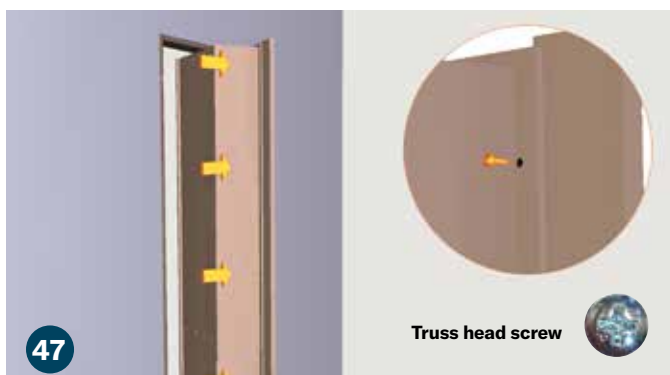

Secure with (5) 1-1/4" truss head screws (D) making sure not to drill through other side of front casing.

Congratulations.

This completes the Murphy Door Flush Mount Unassembled installation procedure.