



MURPHY DOOR

Flush Mount Door - Quick Kit



BILT
3D interactive instructions

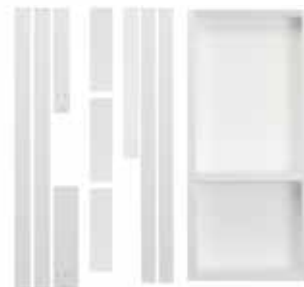

murphydoor.com | 888.458.5911

PLEASE READ INSTRUCTIONS FULLY BEFORE YOU BEGIN ASSEMBLY

PAINTING REQUIRED*

Bookcase, jamb, casing, and shelves require painting prior to assembly.

To assemble the door you will need:

- Tape Measure
- Carpenters Square
- 2' and 6' Level
- Drill
- Countersink Bit
- Phillips Head Bit
- 1/8" Drill Bit
- Adjustable Wrench
- Hammer/Brad Nailer
- Finish Nails
- Wood Glue

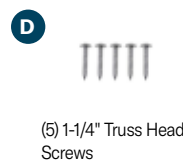
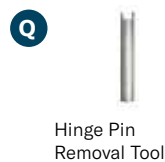
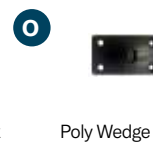
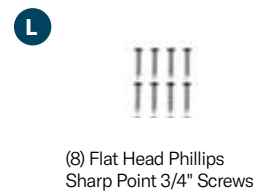
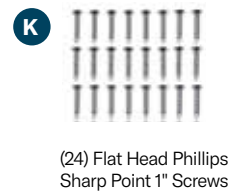
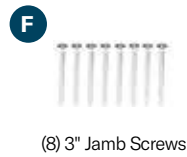
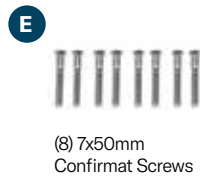
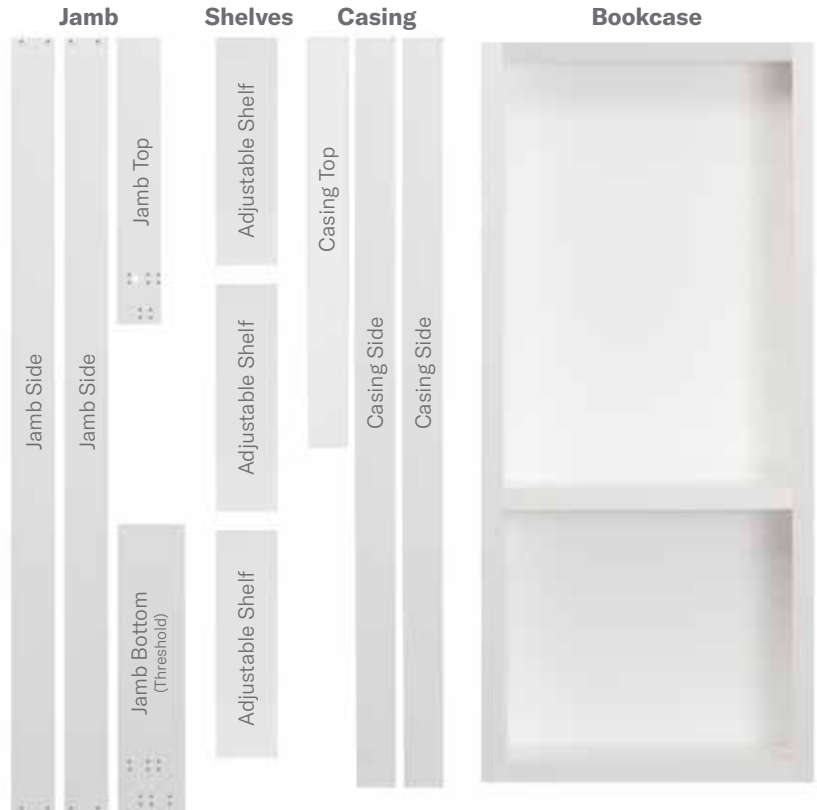

PLEASE READ INSTRUCTIONS FULLY BEFORE YOU BEGIN ASSEMBLY

**Right hand,
in or out-swing**

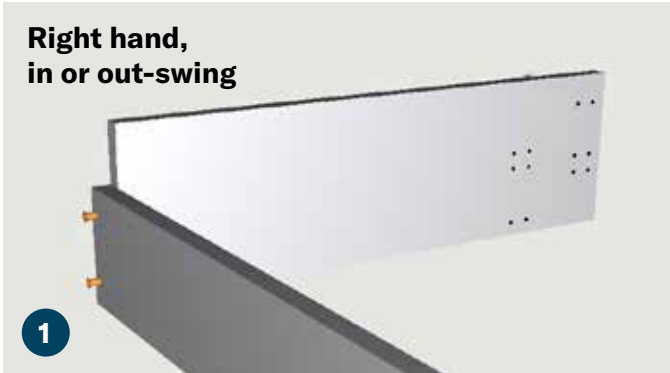

Align the jamb bottom threshold and (1) jamb side on a flat surface. The pre-drilled hinge holes on the jamb bottom threshold will be on the right for a right hand in or out-swing, on the left for a left hand in or out-swing. After ensuring the corner is square; attach the jamb bottom threshold to the jamb side using (2) 7 x 50mm confirmat screws (E).

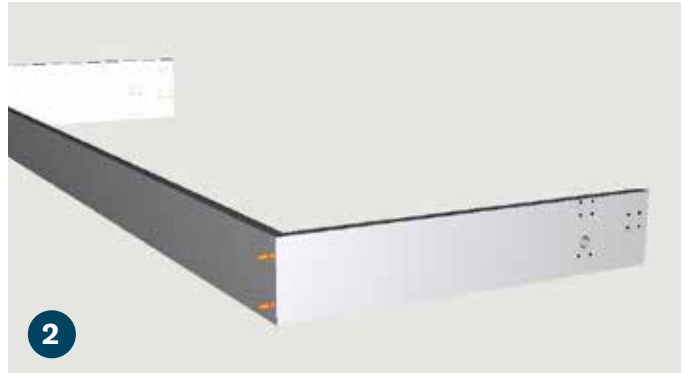

Position the jamb top ensuring that the pre-drilled hinge holes are on the same side as jamb bottom hinge holes. After ensuring the corners are square; attach the jamb top to the jamb side using (2) 7 x 50mm confirmat screws (E).

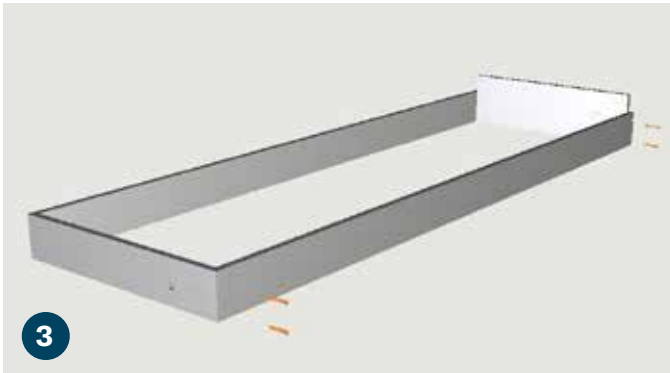

Align the remaining side jamb to the assembly, ensuring all corners are square, and attach it using (4) 7 x 50mm confirmat screws (E).

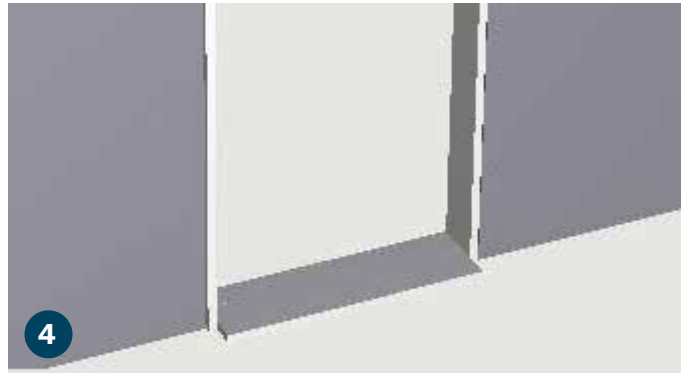

Place the door jamb assembly into the rough opening. The jamb bottom threshold should extend into the room toward the back of the bookcase.



It is critical that the jamb bottom threshold and jamb sides are level. If the door jamb assembly is not level and plumb the door will not swing and close properly.

Note: The jamb bottom threshold **SHOULD NOT** be installed over carpet. Carpet will affect levelling and prevents proper function of the door.



Using a 1/8" drill bit, pre-drill and countersink three holes into each of the jamb sides 2" from the top, 2" from the bottom, and in the middle.

Then pre-drill and countersink 1 hole into the jamb top 6" from each jamb side.

PLEASE READ INSTRUCTIONS FULLY BEFORE YOU BEGIN ASSEMBLY

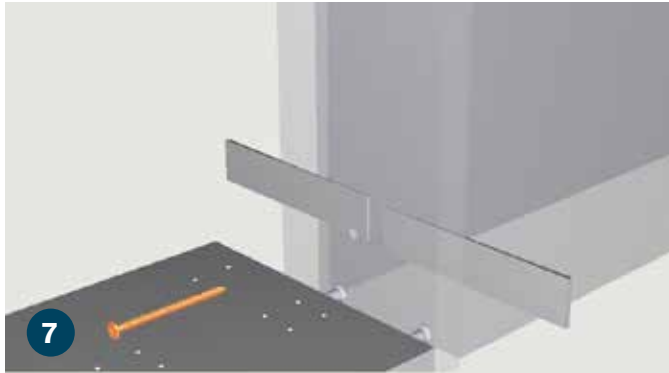

Using shims where needed, install (1) 3" jamb screws (F) making certain the top and sides of jamb are level.

Note: The screws included are meant for a wood frame. If installing the jamb into a steel frame, replace the screws with (8) 3" self-tapping screws.

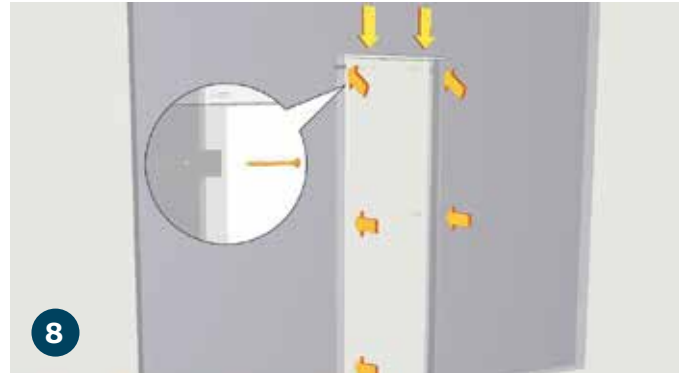

Using shims where needed, install (7) 3" jamb screws (F) making certain the top and sides of jamb are level.



To install a right hand, in-swing door align the holes in the upper jamb hinge (G) with the pre-drilled holes in the jamb top and attach using (4) flat head Phillips sharp point 1" screws (K). For a left hand door use the same pre-drilled hole on the opposite side for all hinge placement.



Align the holes in the bottom jamb hinge (H) with the pre-drilled holes in the jamb bottom threshold and attach using (5) flat head Phillips sharp point 1" screws (K).

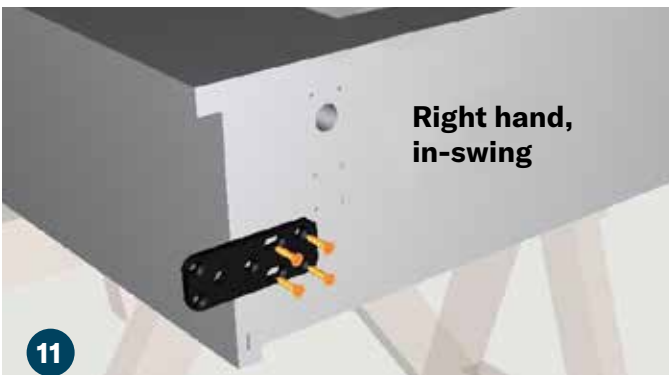

Align the holes in the top hinge plate (I) to the pre-drilled holes on the top bookcase assembly and attach using (4) flat head Phillips sharp point 1" screws (K).



Align the holes in the bottom pivot hinge (J) to the pre-drilled holes at the bottom of the bookcase assembly and attach using (4) flat head Phillips sharp point 1" screws (K).

PLEASE READ INSTRUCTIONS FULLY BEFORE YOU BEGIN ASSEMBLY



For a right-hand, out-swing door align the holes in the upper jamb hinge (G) to the pre-drilled holes in the jamb top and attach using (4) flat head Phillips sharp point 1" screws (K). Make sure that you only use four screws. **DO NOT** drill into the two holes closest to the edge of the jamb as this can split your edge.



Align the bottom jamb hinge (H) to the pre-drilled holes in the jamb bottom threshold and attach using (6) flat head Phillips sharp point 1" screws (K).

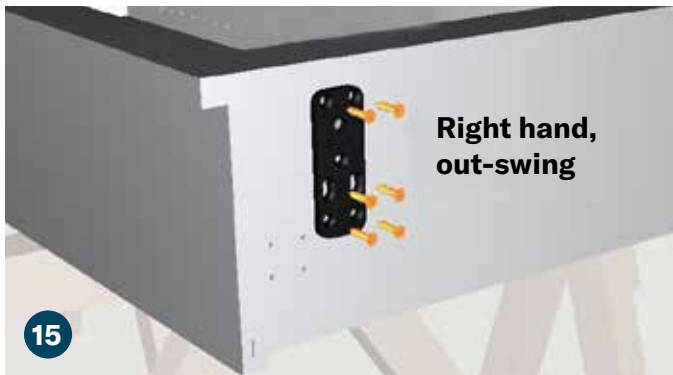

Align the top hinge plate (I) to the pre-drilled holes in the top bookcase assembly and attach using (6) flat head Phillips sharp point 1" screws (K).



Align the holes in the bottom pivot hinge (J) to the pre-drilled holes at the bottom of the bookcase assembly and attach using (6) flat head Phillips sharp point 1" screws (K).

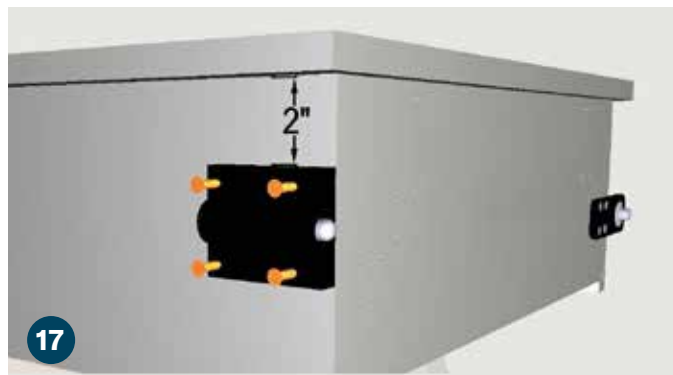

The friction door catch is installed on the door side opposite the hinge and flush to the bottom. Measure 2" from the back of the door face frame and make a mark. Position the friction door catch (M) at this mark, flush to the door bottom. Secure the catch using (4) flat head Phillips sharp point 3/4" screws (L).

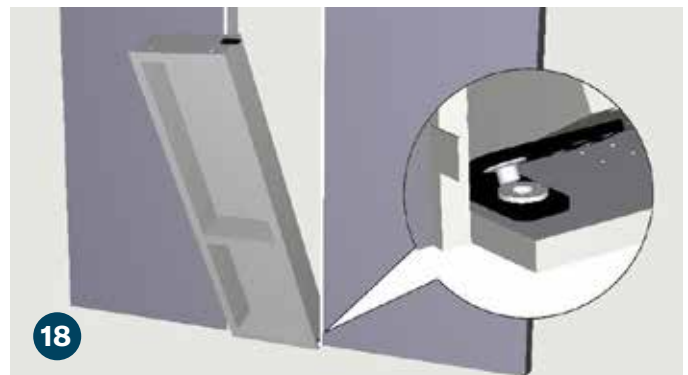

Place the door into the door jamb assembly. Ensure the bottom pivot hinge sits in the silver thrust bearing of the bottom jamb hinge.

PLEASE READ INSTRUCTIONS FULLY BEFORE YOU BEGIN ASSEMBLY

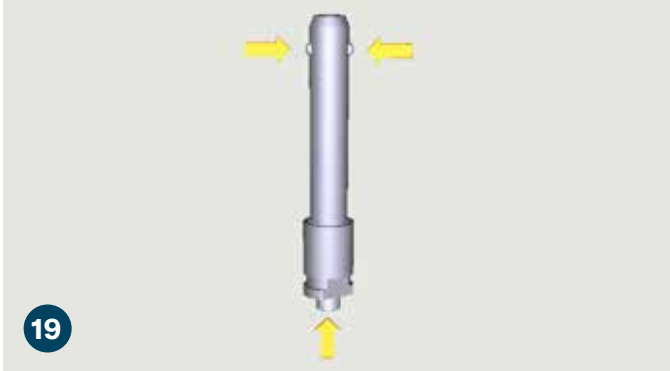

Press down on the ball lock of the hinge pin (N) to retract the two top pins.

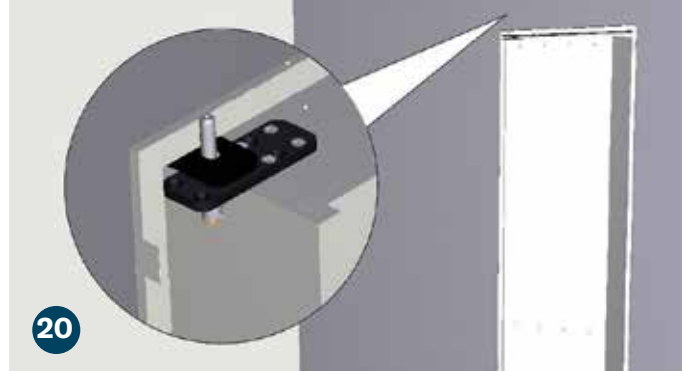

For an in-swing door, align the hole in the bookcase top hinge plate with the hole in the upper jamb hinge. Depress the hinge pin button and insert the hinge pin into the holes. Ensure that the pin locks into place.

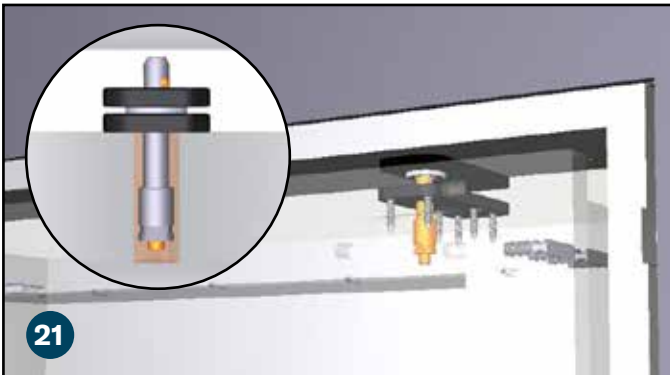

For an out-swing door the hinge pin inserts from the front side of the bookcase. Align the hole in the top of the bookcase with the hole in the top door hinge. Depress the hinge pin button and insert the hinge pin. The hinge pin will appear countersunk when properly installed and locked into place.

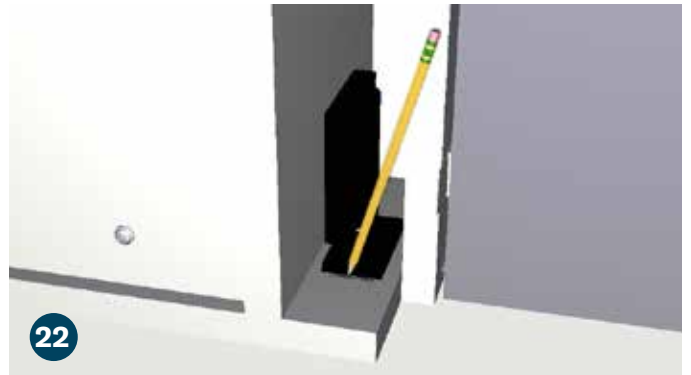

Place the poly wedge (O) where the doorstop carriage bolt will go when the door is closed. Ensure that the door is flush. Mark the poly wedge location with a pencil or tape.

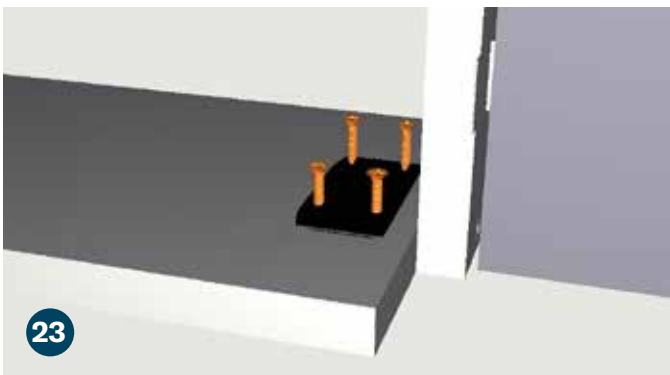

Remove the paper backing from the poly wedge and place it in the marked location. The wedge taper should face in for an in-swing door and out for an out-swing door. Secure with (4) flat head Phillips sharp point 3/4" screws (L).

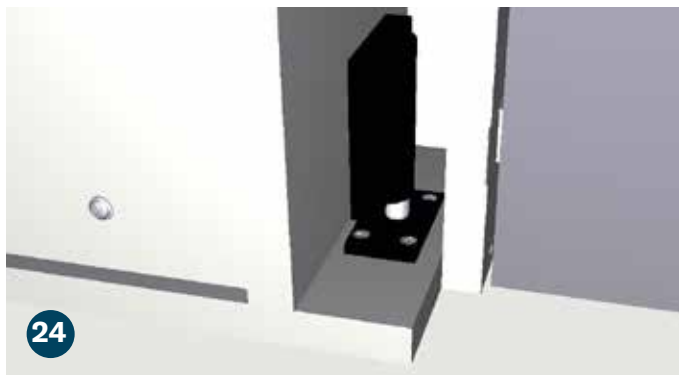

Now that the door assembly is in place use an adjustable wrench to tighten the carriage bolt just enough to catch the poly wedge.

PLEASE READ INSTRUCTIONS FULLY BEFORE YOU BEGIN ASSEMBLY

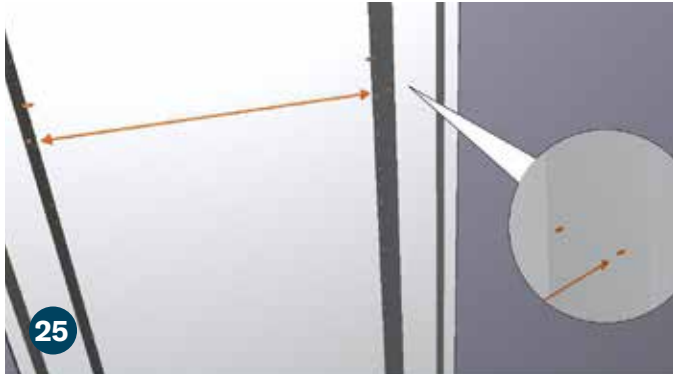

25 Choose a desired height for the adjustable shelf and insert (4) shelf pins (P) into the bookcase, making sure all pins are at the same height.

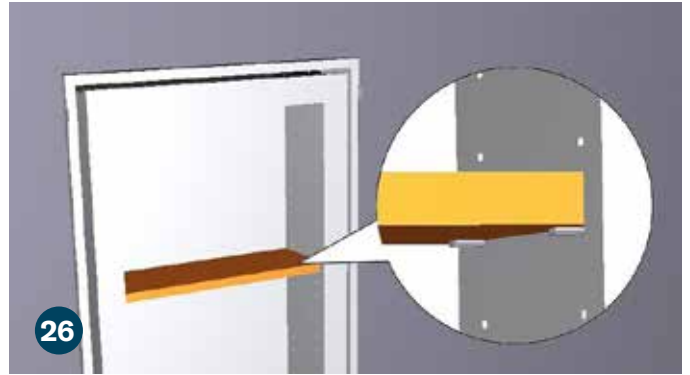

26 Slide the adjustable shelf into place onto the installed shelf pins. Repeat the previous step to insert the remaining adjustable shelves where desired.



27 For an in-swing door, position the top casing with a 1/2" overhang on the face frame of your door and attach using a brad nailer and finishing nails.

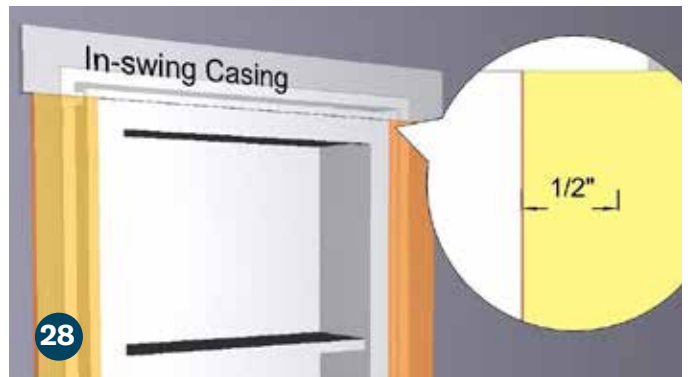

28 Position the right and left side casings* with a 1/2" overhang on the face frame of the door. Attach using a brad nailer.

*Due to variances in home construction, cutting the side casing may be necessary. We recommend cutting the bottom edge for the most professional finish. Alternatively, you may install the uncut side casings first and then the top casing.

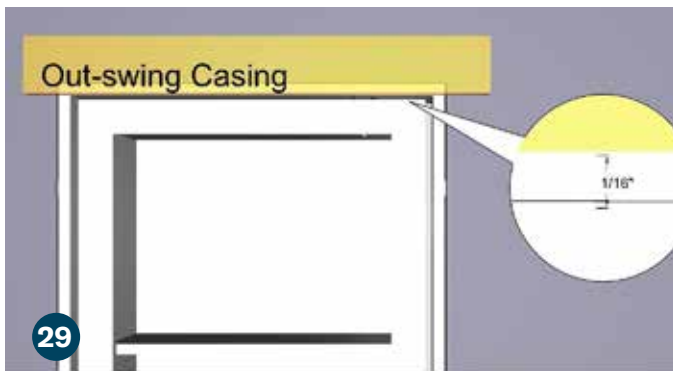

29 For an out-swing door, center the top casing over the door leaving a 1/16" clearance over the door itself. Attach using a brad nailer.



30 With a 1/2" overlay over the door face frame, attach the right side casing using a brad nailer and finishing nails.

*Due to variances in home construction, cutting the side casing may be necessary. We recommend cutting the bottom edge for the most professional finish. Alternatively, you may install the uncut side casings first and then the top casing. This may cause a more noticeable gap at the top opening.

PLEASE READ INSTRUCTIONS FULLY BEFORE YOU BEGIN ASSEMBLY

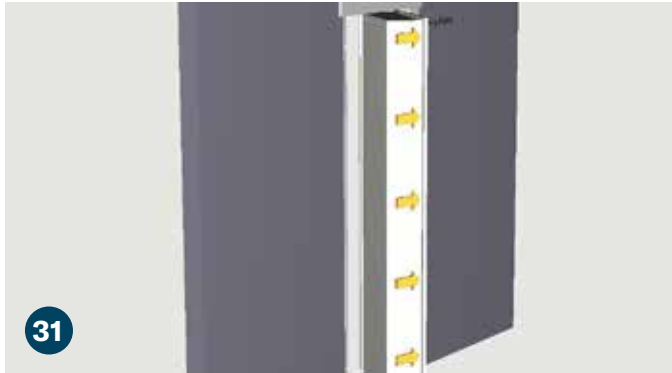

Using a 1/8" drill bit pre-drill five holes into the left support face frame. This will make it easier to attach the left side casing.



Run a bead of glue down the face frame of the door to strengthen the left casing.



Position the left side casing. Test the door swing to ensure it does not contact the floor before securing the side casing with screws.



Secure the left casing to the face frame of the door using (5) 1-1/4" truss head screws (D). Make sure not to drill through other side of front casing.

Congratulations.

This completes the Murphy Door Quick Kit installation process.

1 Year Warranty (U.S.A. only)

Murphy Door warrants your door against defects in material and workmanship under normal use and maintenance for a period of one (1) year from the date of original purchase.

Murphy Door Inc. will provide a replacement part for any part found to be defective. Original part(s) approved for return by Murphy Doors customer service department must be returned prepaid. This warranty does not include labor charges connected with the determination or replacement of defective parts, or freight charges to ship these parts.

Murphy Door Inc. shall not be liable under this or any implied warranty for incidental or consequential damages. This warranty gives the retail customer specific legal rights and the customer may have other rights which vary from state to state.

This warranty shall be void if the unit is not assembled or operated in accordance with the operation instructions provided with this unit; the unit is re-sold or traded to another owner; components, accessories; or the user has abused or otherwise failed to maintain the unit.

To process a warranty claim, Murphy Door requires you to register your product on our BILT app and proof of your date of purchase. You should retain your sales slip or invoice with your valuable documents.