



MURPHY DOOR®

Flush Mount Door - pre-hung



For use with Bookcase, Dresser, Gun Cabinet, Hamper, Mirror Closet, Pantry, Pool Cue, Shoe Rack, Spice Rack, and Wine Rack Doors.

murphydoor.com | 888.458.5911

PLEASE READ INSTRUCTIONS FULLY BEFORE YOU BEGIN ASSEMBLY

Our hidden flush mount doors have unique finishing details. To ensure proper installation, make sure that all instructions are read and understood by whoever is installing your door.

The cabinet of your hidden door is 1-1/2" to 2" narrower than the jamb. This allows for the proper function of the door. The gaps will be covered by finish casing. In-swing and out-swing casing and hinges are placed differently. It is important to follow the installation instructions for the door swing selected. There will be some wall finish work needed where the wall meets the jamb. For best results prep the wall with the sheet rock edge cut as straight and clean as possible.

01

Storage

If you are not installing door on receipt keep it standing level on its base or lay it flat. **DO NOT** lean it against a wall on its edge.

02

Proper handling

Take door/cabinet out of jamb and carry cabinet and jamb separately. **DO NOT** carry or lift the cabinet by the face frame.

The doors are heavy, handle with care. You will need to support the entire door when carrying and lifting the door. A minimum of two persons recommended.

Murphy Door can not be responsible for dropped door damage

03

Content check

Verify that you have all parts prior to starting the installation or hiring a contractor.

Test your pin to make sure it works properly. Hold the pin while pushing the center button. The two ball bearings should retract slightly. If the ball bearings do not retract spray with dry lube. Re-engage the center button several times to see if pin is working properly. The pin should not be used if not working correctly.

04

Painting/staining

If you are finishing your door with paint or stain, it should be done within 10 days to seal the wood to minimize climate differences. Unfortunately, Murphy Door can not offer a warranty against sagging or warping on unfinished doors.

Use care when applying. Keep pre-drilled holes free of excess paint or stain to make assembly easier.

DO NOT use water-based paints. Commercial grade furniture paints and stains are required.

Always do a sample test with your paint or stain. The sides of the jamb that will be placed against the wall are great places to test, as they will not be seen once the door is installed.

Always follow the paint or stain instructions when applying to your door.

05

Uninstalling your door

Out-swing Door

Take pressure off the door. The pin must be vertical and the holes of the hinges must be aligned. If there is too much friction, the pin will not easily slip out of the hinges.

Locate hinge pin in the top of the cabinet through a 1" hole. Put the hinge pin removal tool up around the pin. Carefully pull the pin down as you slightly wiggle the removal tool. Once top pin is out, you can lift the door off the bottom hinge.

In-swing Door

Take pressure off the door. The pin will be mounted to the side of the door.

Push the button on the pin, while pulling the pin down as you wiggle it down and out. Once top pin is out, you can lift the door off the bottom hinge.

If you lose the pin removal tool, you can order another at murphydoor.com

06

Installation Tips

Framing

Rough opening should be framed with 2"x 4" or 2"x6" studs. Make sure your studs are parallel (measure top, middle, and bottom of the jamb RO) and square (by putting a square in all four corners). If they are not, your Murphy Door will not function properly and may appear bowed. If using metal studs, replace the included 3" screws with (8) 3" self-tapping screws.

Threshold

For best results install the door on a level surface. DO NOT install the bottom threshold over carpeting. Carpet will affect levelling and prevent proper function of the door. If you must shim the threshold, the shim should be the width of the threshold and runs the entire length of space needed to shim.

Jamb

DO NOT over or under tighten jamb. When installing the jamb you need to make sure it is shimmed properly. It should be level and square with the threshold and header. If the jamb is not square it may cause your door to function improperly or appear to sag.

Hinge Pin Installation

On out-swing doors make sure the pin goes up through the hole in the top of the door and through both hinges. DO NOT put the pin in from the top down. If properly installed the pin will countersink and the button will be fully extended (not depressed). If it protrudes below the header it is not properly seated and may fail causing the door to fall out. BE CERTAIN that the hinge pin is seated and goes through both hinges.

Casing (aka Trim)

Make sure your door opens, closes, and swings properly prior to installing the casing. Our casing is designed so the top casing goes past the side casings 1-1/2" per side.

Attach vertical casing first then top casing. This will make it easier to visually center the top casing.

Finishing

Make sure your door works properly before you finish the wall. Caulk, mud, or tape to finish the edge where the wall meets the jamb.

PLEASE READ INSTRUCTIONS FULLY BEFORE YOU BEGIN ASSEMBLY

To assemble the door you will need:

- Tape Measure
- Drill
- Countersink Bit
- 1/8" Drill Bit
- Finish Nails
- 2' and 6' Level
- Wood Glue

Shelves



Casing



(5) 1 1/4" Truss Head Screws



(8) 3" Jamb Screws



(12) Shelf Pins



Hinge Pin Removal Tool

1 Year Warranty (U.S.A. only)

Murphy Door warrants your door against defects in material and workmanship under normal use and maintenance for a period of one (1) year from the date of original purchase.

Murphy Door Inc. will provide a replacement part for any part found to be defective. Original part(s) approved for return by Murphy Doors customer service department must be returned prepaid. This warranty does not include labor charges connected with the determination or replacement of defective parts, or freight charges to ship these parts.

Murphy Door Inc. shall not be liable under this or any implied warranty for incidental or consequential damages. This warranty gives the retail customer specific legal rights and the customer may have other rights which vary from state to state.

This warranty shall be void if the unit is not assembled or operated in accordance with the operation instructions provided with this unit; the unit is re-sold or traded to another owner; components, accessories; or the user has abused or otherwise failed to maintain the unit.

To process a warranty claim, Murphy Door requires you to register your product on our BILT app and proof of your date of purchase. You should retain your sales slip or invoice with your valuable documents.

PLEASE READ INSTRUCTIONS FULLY BEFORE YOU BEGIN ASSEMBLY



1
Locate the hinge in the upper corner of the door. Place the hinge pin removal tool (Q) on the hinge pin to retract and pull down as shown. On an out-swing door the hinge pin will be countersunk inside of the bookcase.



2
Remove the door from the jamb by lifting it up and off the bottom jamb hinge.



3
Place the door jamb into the rough opening. The bottom jamb threshold should extend into the room toward the back of the bookcase.

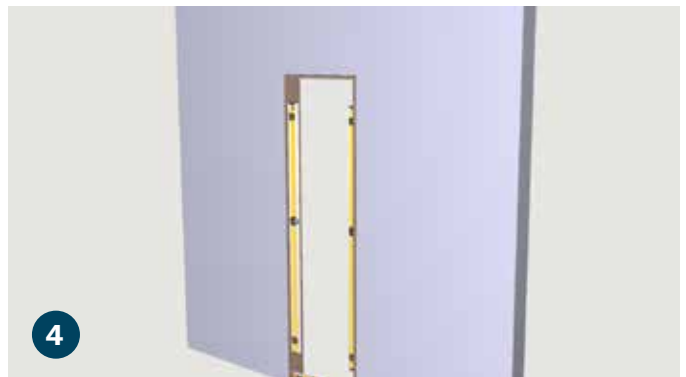

4
It is critical that the bottom threshold and jamb sides are level. If the door jamb is not level and plumb the door will not swing and close properly.

Note: The bottom threshold **SHOULD NOT** be installed over carpeting. Carpet will affect levelling and prevents proper function of the door.

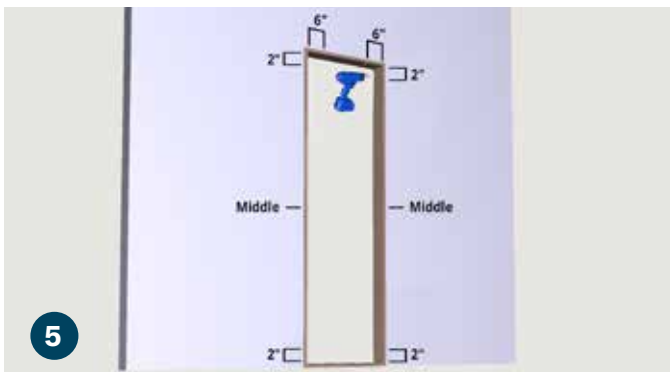

5
Using a 1/8" drill bit, pre-drill and countersink three holes into each side of the jamb, 2" from the top of the jamb, 2" from the bottom of the jamb, and in the middle. Next pre-drill and countersink two holes into the jamb top, 6" from the right and left sides of the jamb.

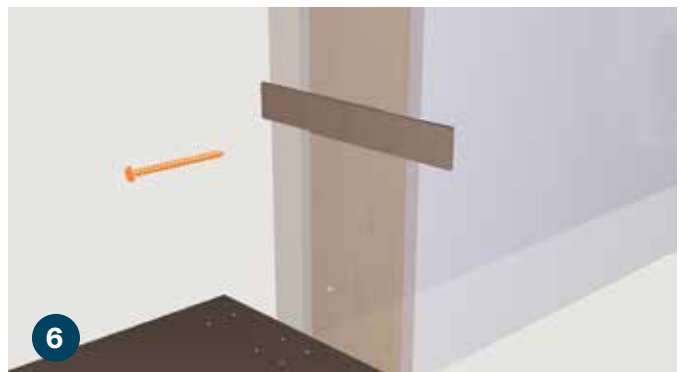

6
Using shims where needed, install (8) 3" jamb screws (F) making certain the top and sides of the jamb are level.

Note: The screws included are meant for a wood frame. If installing the jamb into a steel frame, replace the screws with (8) 3" self tapping screws.

PLEASE READ INSTRUCTIONS FULLY BEFORE YOU BEGIN ASSEMBLY

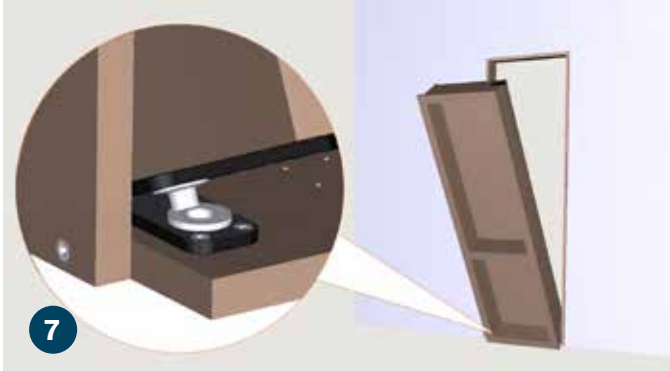

7 Place the door into the door jamb, making sure that the bottom pivot hinge sits in the silver thrust bearing.

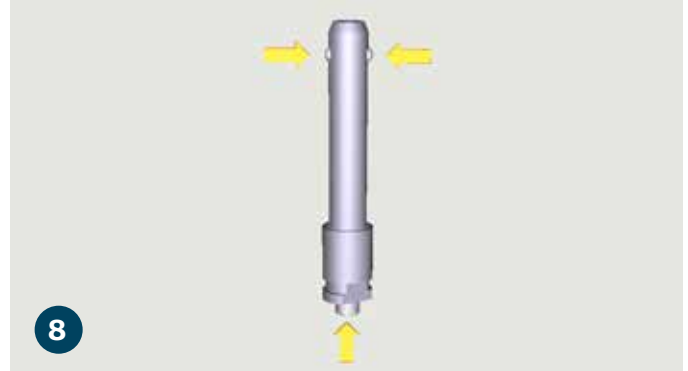

8 Press down on the ball lock of the hinge pin to retract the two top pins.



9 Align the holes of the bookcase top jamb hinge and the top door hinge. Depress the hinge pin button and insert making certain that it locks into place. On an out-swing door the pin will insert from the front of the bookcase and appear countersunk when properly locked.

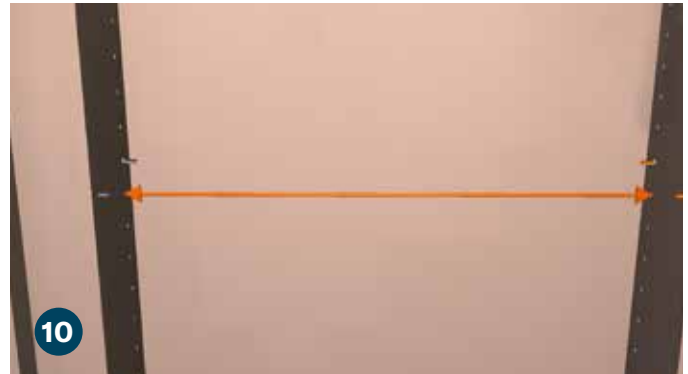

10 Add (4) shelf pins (P), 2 on each side of the bookcase at equal heights.

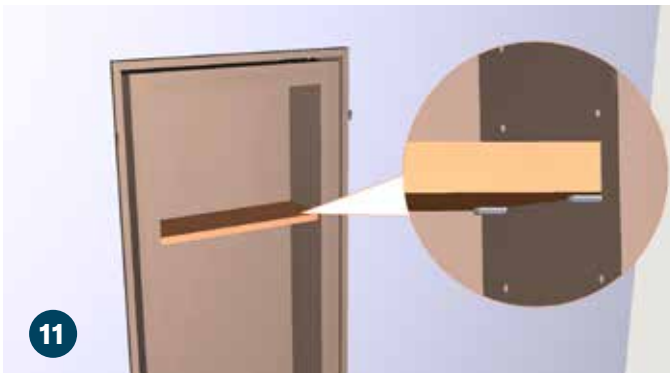

11 Slide the shelf into place onto the installed shelf pins. Do the same for the remaining shelves.

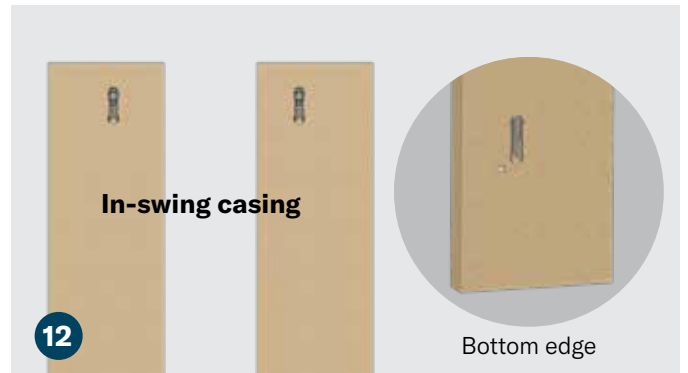

12 Determine which side casing is the hinge side. The hinge side (the casing on the right in the image above) will have the clip pockets slightly closer to the inside edge. Use a measuring tape to check if you are unsure.

PLEASE READ INSTRUCTIONS FULLY BEFORE YOU BEGIN ASSEMBLY

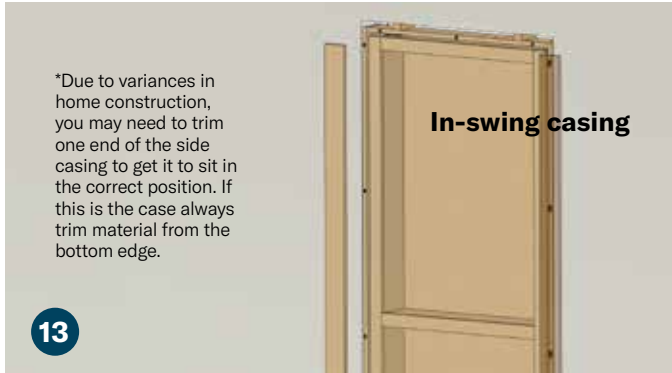

Align the clips in the casing and on the jamb. Press firmly into place. The bottom edge is indicated with a small, drilled hole on the back side near the bottom clip pocket. The top edge of the side casing should sit about 1/2" below the top of the door. If it is higher than this, firmly grip the side casing and slide it down until it stops.

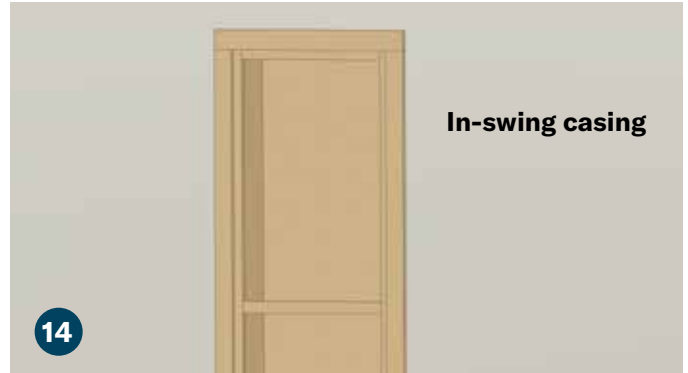

Apply a bead of glue along the front edge of both side jambs and the top jamb. Align the clips in the top casing the same way you did the side and press firmly into place. Adjust the top and side casing until they sit flush against each other and are square.



Test the in-swing to ensure the door opens and closes smoothly. Allow the glue to dry overnight.

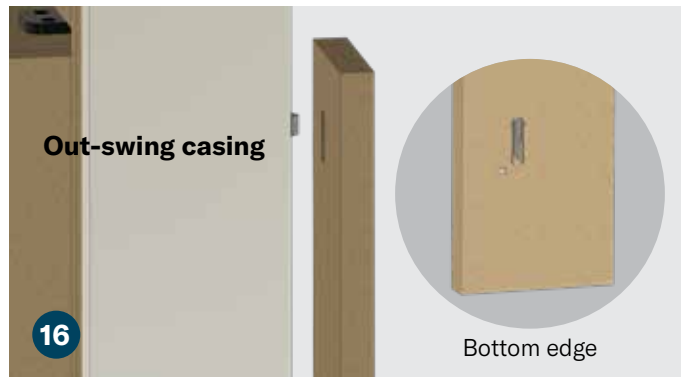

Align the clips in the casing and on the jamb. Press firmly into place. The bottom edge is indicated with a small, drilled hole on the back side near the bottom clip pocket.

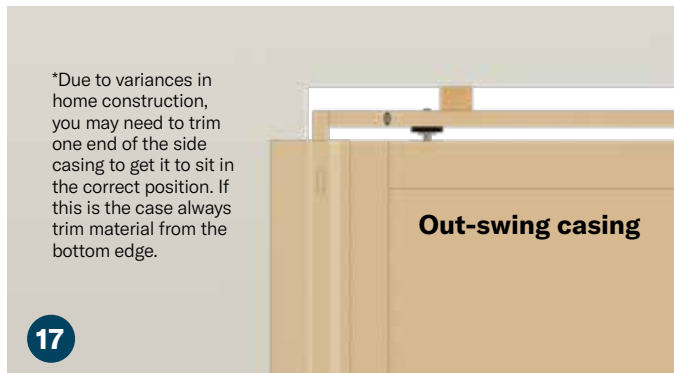

The top of the right-side casing should sit about 1/16" above the top of the door. If it is higher than this firmly grip the side casing and slide it down until it stops.



Align the clips in the top casing the same way you did the side and press firmly into place. Adjust the top and side casing until they sit flush against each other and the gap between the top casing and the top of the door is uniform.

PLEASE READ INSTRUCTIONS FULLY BEFORE YOU BEGIN ASSEMBLY



Using a 1/8" drill bit pre-drill and countersink five holes into the left support face frame. This will make it easier to attach the left side casing.



Run a bead of glue down the face frame of the door to strengthen the left casing.



Position and attach the left side casing. Test the door swing prior to screwing in to ensure it doesn't make contact with the floor.

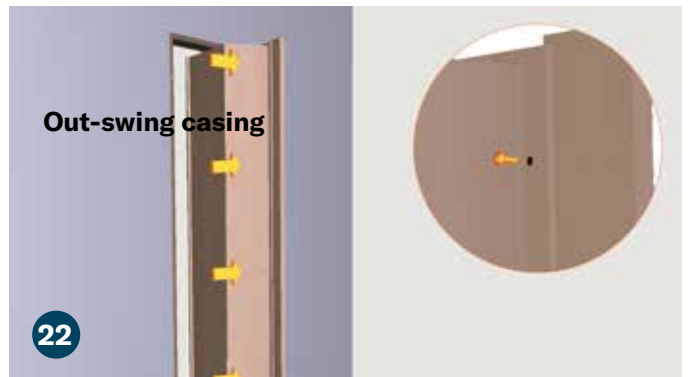

Secure with (5) 1-1/4" truss head screws (D) making sure not to drill through other side of front casing.



After the left casing has been attached, remove the top and side casing by sliding them up 7mm to release the clips. The casing will then pull free from the clip. Run a bead of glue on the edge of the top and right-side jambs, then re-apply the casing. Adjust the top and side casing until they sit flush against each other and the gap between the top casing and the top of the door is uniform and allow the glue to dry overnight before using the door.

Congratulations.

This concludes the Murphy Door Pre-hung Flush Mount installation procedure.