

 Anodized aluminum stand with 8 pcs. A4 polycarbonate brochure holders and logo plate (45 x 16 cm). For indoor use.

 Eloxiertes Aluminium Ständer mit 8 Stück A4 Polycarbonat Prospekthalter und Logoplatte (45 x 16 cm). Für den Innenbereich.

 Eloxeret aluminiumsstander med 8 stk. A4 polycarbonat brochureholdere og logoplate i top (45 x 16 cm). Til indendørs brug.



Model	Art. no.	Capacity	Colour	Total W x H	Base	Weight	Pallet size and quantity
920	2872	8 x M65	Alu / Acrylic	45 x 190 cm	Ø 45 cm	22 kg	80 x 120 x 220 cm 20 pcs.
-	2873	8 x A5	-	45 x 190 cm	-	25 kg	80 x 120 x 220 cm 20 pcs.
-	2874	8 x A4	-	58 x 190 cm	-	28 kg	80 x 120 x 220 cm 20 pcs.

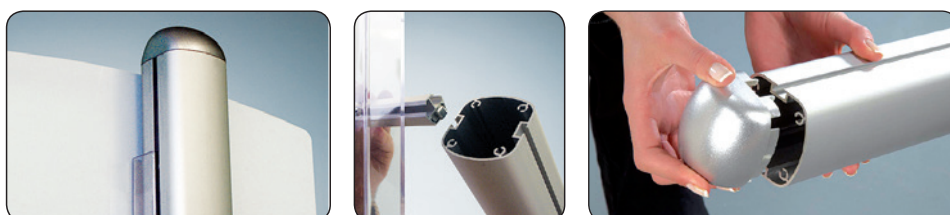
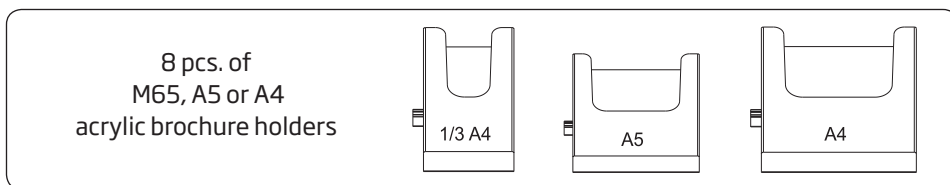
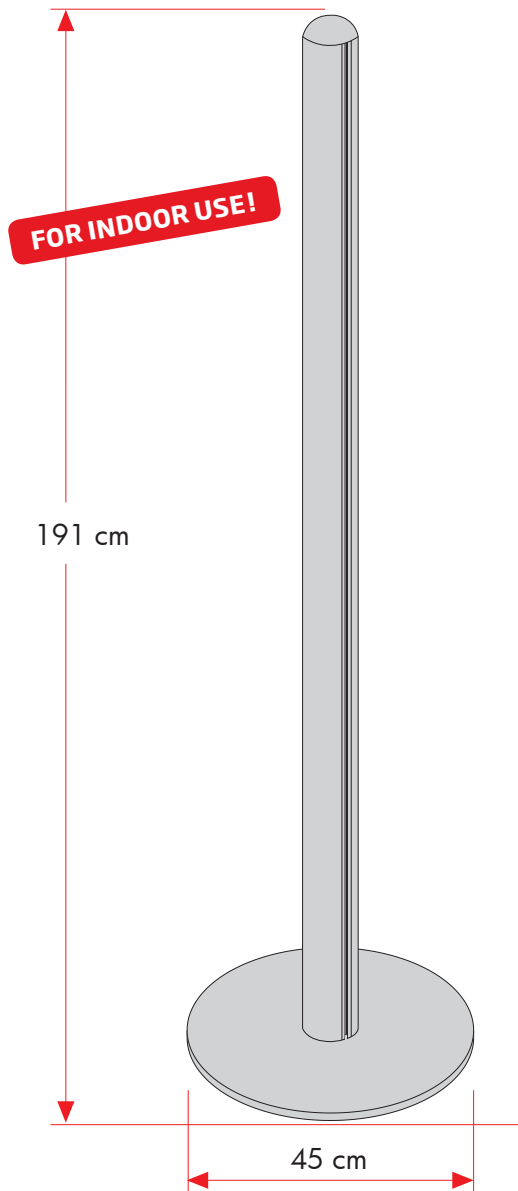
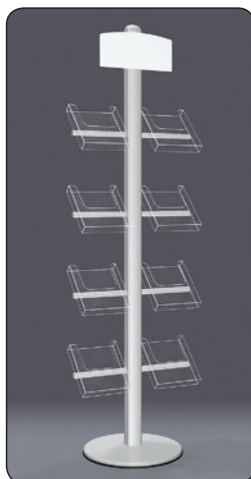
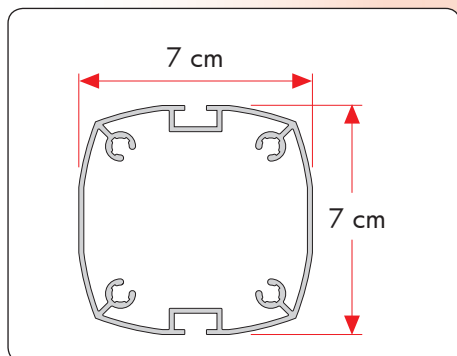
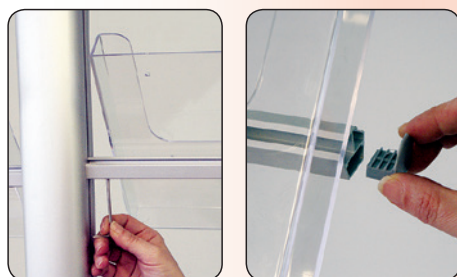

- Slide the shelf stand profile through the pole's channel, fix it on the desired position.
- Ablage profil durch den Kanal schieben. In der erwünschten Höhe mit Inbusschlüssel festziehen.

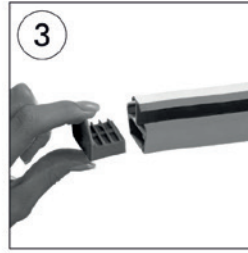
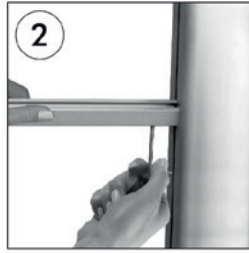

- Take off the end cap on the shelf stand profile.
- Endkappe am Ablageprofil abnehmen.

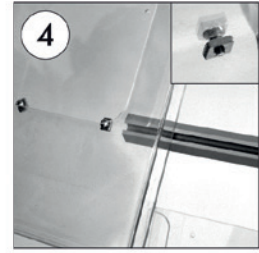

- Slide the transparent shelves connectors through the channel of the shelf stand profile
- Die Mutter an der transparenten Ablage durch Kanal durchstechen.

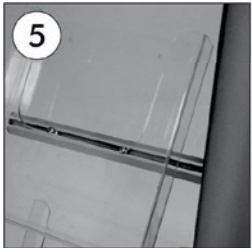

- Place the shelf to the suitable position. Hold it tight by screwing.
- Bringen Sie die Ablage in die richtige Position und ziehen Sie die darauf befindliche Schrauben fest.

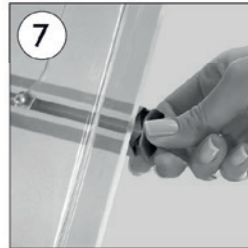
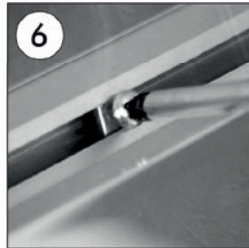

- Put the end caps back on the shelf stand profile.
- Die Endkappe darauf stechen.

