

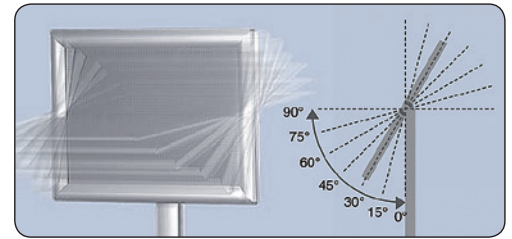

🇬🇧 Alu info stand with a heavy foot. A4, A3 or A2 snap-frame profile, 25 mm, corners cut in mitred. Anti-reflex APET front panel. Flexible height and adjustable position - vertical or horizontal - slanting or straight.

🇩🇪 Aluminium Infoständer mit einem schweren Fuss. A4, A3 oder A2 Snap-Frame Profile, 25 mm mit Ecken auf Gehring. Entspiegelte APET Frontplatte. Variable Höhe und verstellbar - vertikal oder horizontal - schräg oder senkrecht.

🇩🇰 Aluminium infostander med kraftig fod. A4, A3 eller A2 Snap-Frame med 25 mm profil og hjørner i gering. APET anti-reflex frontplade. Justérbar højde og valgfri indstilling - vertikal eller horisontal - skrå eller lige.

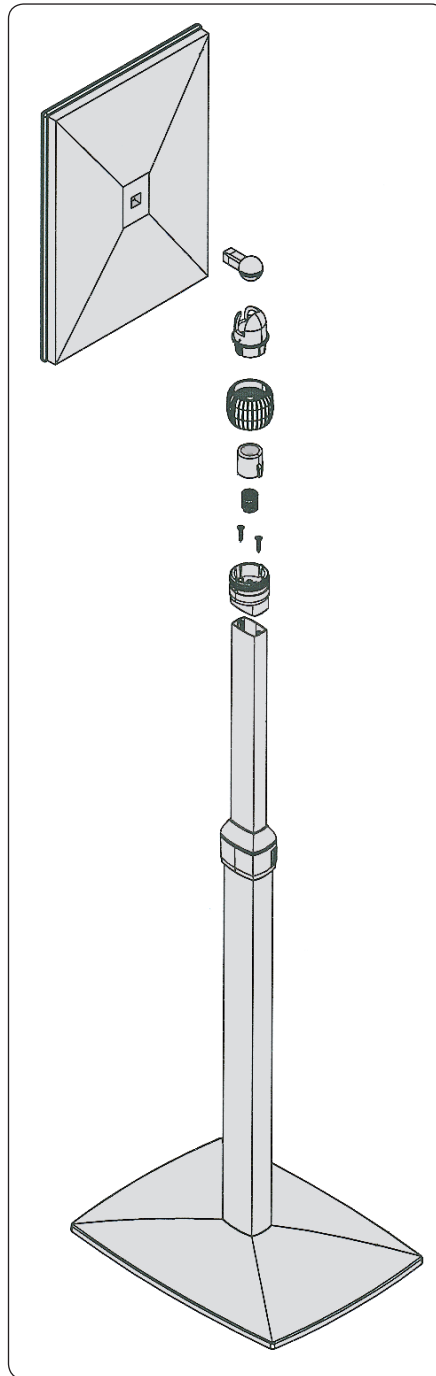

ADJUST TO THE POSITION YOU LIKE ...
CHOOSE A4 OR A3

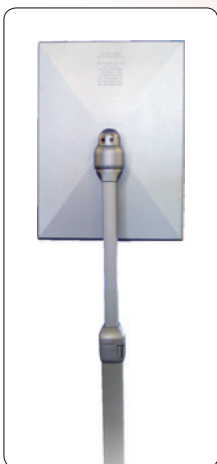
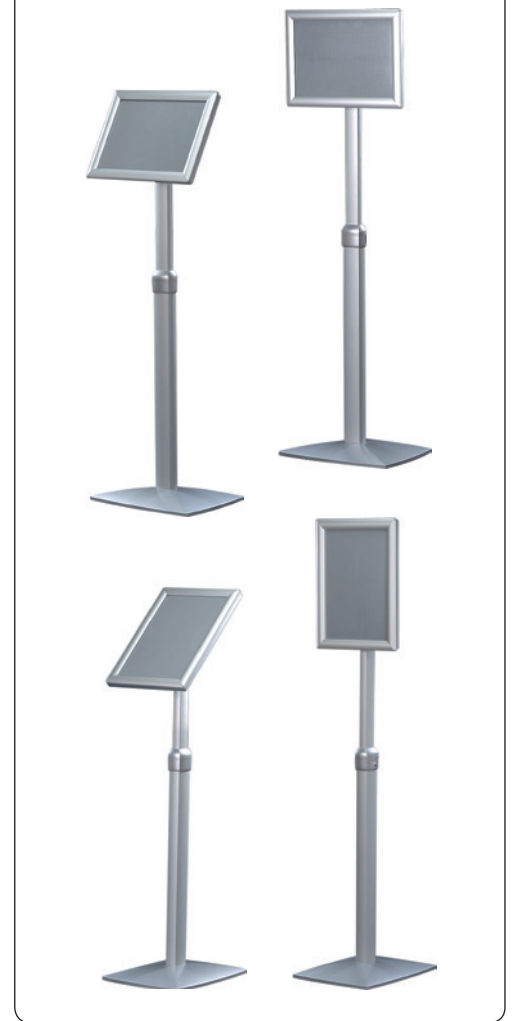

Model	Art.no.	Poster size	- visible part	Colour	Total W x H	Base	Package size and weight	Pallet size and quantity
805	6489	21 x 29,7 cm A4	19,2 x 27,9 cm	Alu	33 x up to 125 cm	25 x 33 cm	27 x 102 x 10 cm 5 kg	80 x 120 x 130 cm 30 pcs.
-	6490	29,7 x 42 cm A3	27,9 x 40,2 cm	-	42 x up to 130 cm	30 x 42 cm	36 x 110 x 10 cm 8 kg	80 x 120 x 130 cm 22 pcs.
-	6491	42 x 59,4 cm A2	40,2 x 57,6 cm	-	60 x op til 138 cm	30 x 42 cm	54 x 136 x 11 cm 12 kg	80 x 136 x 130 cm 14 pcs.

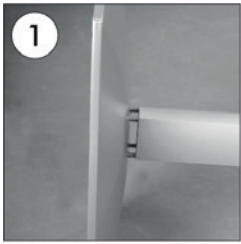

- Complete the stand by screwing the classical base to the convex profile.
- Schrauben Sie den klassischen Fuss an das Convexprofil fest.

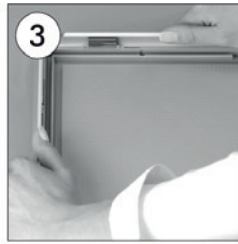
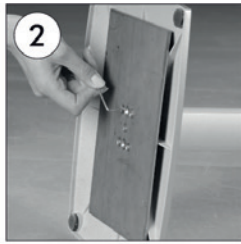

- Open all profiles.
- Alle Profile in der Pfeilrichtung öffnen.

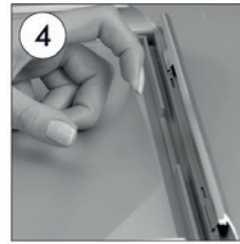

- Take-off the anti-reflex cover.
- Antireflex - Schutzfolie abheben.



- Place the poster in.
- Poster einlegen.



- After placing the cover back on the poster, close the profiles.
- Antireflex-Schutzfolie auf Poster legen und die Seitenprofile in Pfeilrichtung zuklappen.

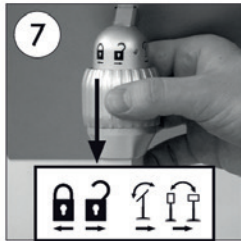

- Take the system into to the opened or closed position by turning the nut at the back of the frame in the direction of arrows as in the figure. In the opened position, you can take the frame system both into the portrait or into the landscape position with a 15 degrees of angle gap. The frame is made fixed when it is taken into the closed position.
- Die Mutter drehend in die Pfeilrichtung können Sie das System entweder freimachen oder schliessen. Im freien Zustand kann der Rahmen je 15° Winkelfixierung vertikal oder horizontal bewegend in die gewünschte Position gebracht werden. Im Falle des Schliessens wird der Rahmen in dieser Lage befestigt sein.

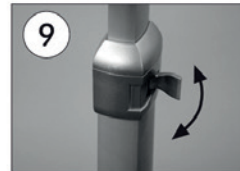
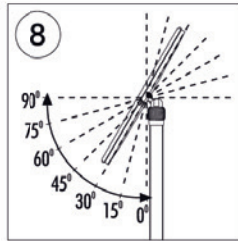

- Adjust the height of the menuboard by opening or closing the fastener on the leg as in the figure.
- Die Höhe des Ständers können Sie einstellen, indem Sie die Klemme am Standrohr wie die Pfeilrichtungen an der Abbildung auf- und zumachend bewegen.



Portrait
Hochformat

Landscape
Querformat

