

 Pavement board with 40 mm alu snap-frame cut in mitred with rounded corners. Antireflex APET front panels. Mounted with black rubber to protect the poster from water. Springs are treated to prevent corrosion. The foot is made of heavy duty plastic material and can be filled with water or sand to give the sign a really good stability even in rough weather conditions. Please add anti-freeze if below 0° C degrees. The two wheels makes the board easy to move around. Easy and fast to assemble.

 Strassenständer mit 40 mm Alu-Profilen, Ecken auf Gehrung und abgerundeten Ecken. Mit ent-spiegelten APET Frontplatten. Mit schwarzem Gummi montiert, zum Schutz gegen Eindringen von Wasser. Die Federn sind gegen Rost behandelt. Der Fuss ist aus schlagfestem Kunststoff hergestellt und kann mit Wasser oder Sand gefüllt werden. Bei Kältegrade mit Frostschutzmittel nachfüllen. Die 2 Rollen erleichtern den Transport des Ständers. Montage schnell und einfach.

 40 mm alu snap-frames skåret i gering og med pæne afrundede hjørner. Antirefleks APET frontplader. Skumliste monteret med ind-trængning af vand. Fjedre er behandlet mod rust. Foden er lavet af slagfast plast og kan fyldes med vand eller sand for virkelig god stabilitet. I tilfælde af frost, påfyldes frostvæske. De to hjul, gør det nemt at flytte skiltet. Let og hurtigt at samle.



Model	Art.no.	Poster size	Colour	Total W x H	Base filled	Package size and weight	Pallet size and quantity
129	6045	50 x 70 cm	Silver/grey	72 x 102 x 58 cm	35 kg	61 x 75 x 18 + 61 x 104 x 5 cm 14,5 kg	80 x 120 x 220 cm 10 pcs.
-	6046	59,4 x 84,1 cm A1	-	72 x 117 x 58 cm	35 kg	61 x 75 x 18 + 72 x 118 x 5 cm 15,0 kg	80 x 120 x 220 cm 8 pcs.
-	6047	70 x 100 cm	-	90 x 132 x 63 cm	43 kg	66 x 93 x 18 + 82 x 134 x 5 cm 19,5 kg	80 x 120 x 220 cm 8 pcs.
-	6048	84,1 x 118,9 cm A0	-	90 x 151 x 63 cm	43 kg	66 x 93 x 18 + 97 x 160 x 5 cm 21,0 kg	100 x 120 x 220 cm 8 pcs.

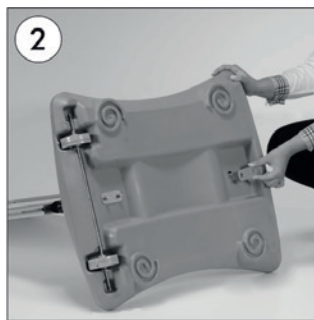
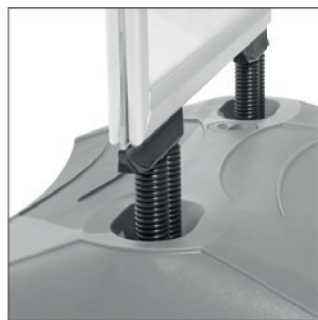

- GB** Place the springs into the holes of the plastic base.  
**DE** Stecken Sie die unter dem Rahmen befindlichen und an die Feder befestigten Schrauben in die Bohrungen am Wassertank.  
**DK** Placer fjederne i hullerne på plastfoden.

- GB** Mount the nuts on the screws under the plastic base.  
**DE** Montieren Muttern auf die Schrauben unten am Wassertank.  
**DK** Monter møtrikkerne på skruerne i bunden af vanddunken.

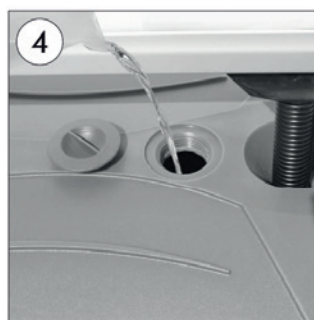
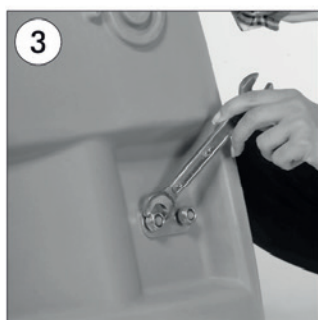

- GB** Fix the base, frame and the springs by tightening the screws with wrench.  
**DE** Mit Hilfe eines Maulschlüssels die Schrauben festziehen.  
**DK** Skru foden, rammen og fjederne sammen med en skruenøgle.

- GB** Fill in the base with water and close the cover cap.  
**DE** Drehen Sie den Deckel am Wassertank auf und füllen Sie ihn mit Wasser.  
**DK** Fyld plastfoden med vand og skru hættten på igen

- GB** Open all profiles.  
**DE** Alle Profile öffnen.  
**DK** Åben profilerne.



- GB** Take-off the front panel.  
**DE** Frontscheibe abheben.  
**DK** Løft frontpladen
- GB** Place the poster under the front panel.  
**DE** Poster unter Frontscheibe einlegen.  
**DK** Læg plakaten ind under frontpladen.

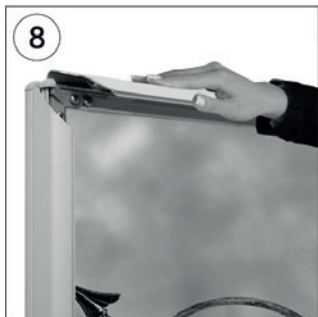

- GB** Close the profiles.  
**DE** Die Seitenprofile zuklappen.  
**DK** Luk profilerne.

