

 Brochure holder made of transparent polystyrene, injection moulded.

 Prospekthalter aus transparenten spritzgussgeformtem Polystyrol hergestellt.

 Brochureholder produceret i transparent sprøjttestøbt polystyren.



USE THE T-SEPARATOR FOR
 ART. 2756 (A4)
 AND GET 2 PCS. M65 ROOMS

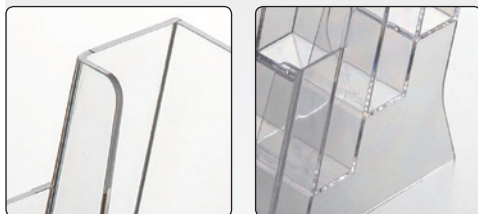
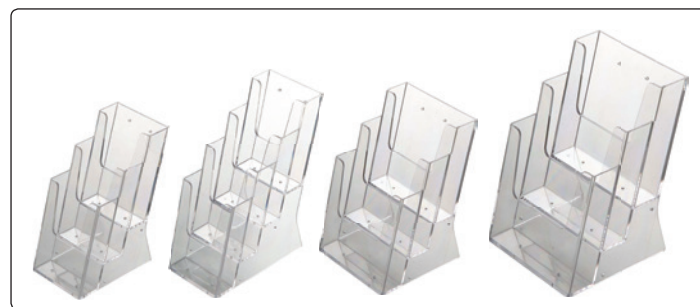
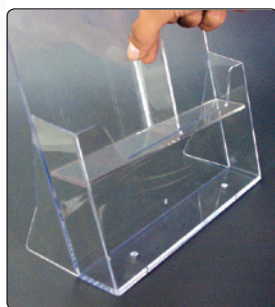
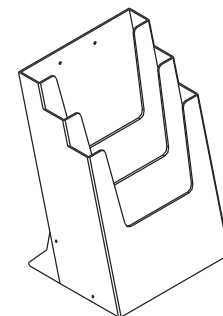
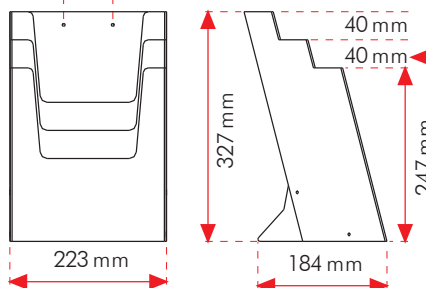
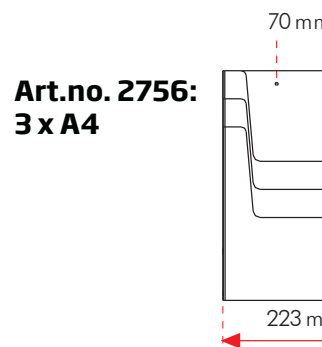
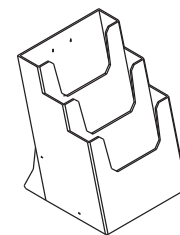
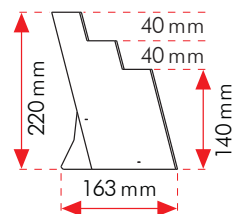
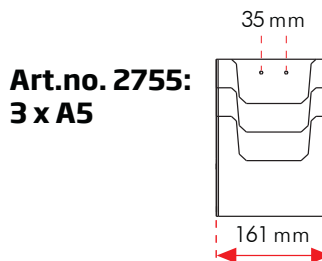
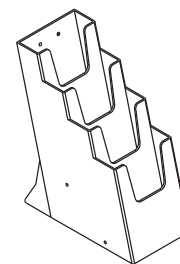
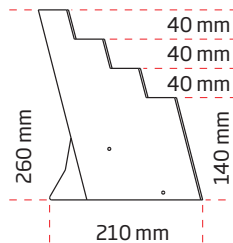
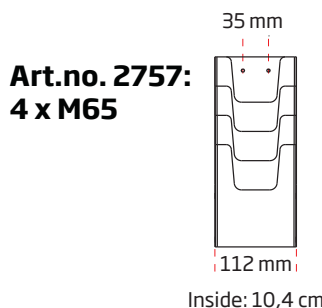
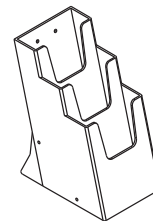
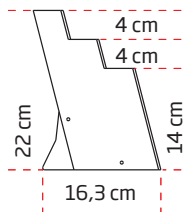
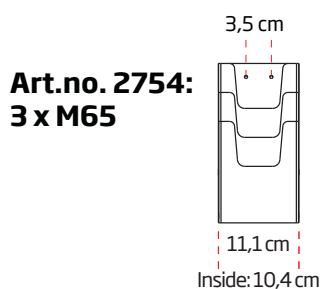

Model	Art. no.	Capacity	Inside W x D	Colour	Total W x H x D	Package size and weight	Pallet size and quantity
1209	2754	3 x M65	10,4 x 3,5 cm	Transparent	11,1 x 22 x 16,3 cm	38 x 83 x 25 cm (20 pcs.) 0,5 kg	80 x 120 x 125 cm 220 pcs.
1209	2757	4 x M65	10,4 x 3,5 cm	Transparent	11,2 x 26 x 21 cm	38 x 70 x 36 cm (18 pcs.) 0,5 kg	80 x 120 x 125 cm 162 pcs.
1209	2755	3 x A5	15,5 x 3,5 cm	Transparent	16,1 x 22 x 16,3 cm	38 x 56 x 35 cm (12 pcs.) 0,6 kg	80 x 120 x 123 cm 144 pcs.
1209	2756	3 x A4	21,5 x 3,5 cm	Transparent	22,3 x 33 x 18,4 cm	35 x 41 x 47 cm (4 pcs.) 0,6 kg	88 x 125 x 112 cm 48 pcs.
	2749	T-separator (for A4)		Transparent	21,5 x 8 x 3,0 cm	45 x 24 x 8 cm (20 pcs.) 0,1 kg	