

# Mini USB PRO Duplicator User Manual





<b>I. Introduction .....</b>	<b>2</b>
1. Features.....	2
2. ControlPanelOverview .....	3
3. Specifications.....	4
<b>II. Warning.....</b>	<b>4</b>
<b>III. Asynchronous Operation.....</b>	<b>5</b>
<b>IV. Menu Overview .....</b>	<b>6</b>
1. Copy .....	6
2. Compare.....	6
3. Utility.....	7
3.1 FormatFAT32 .....	7
3.2 Format exFAT.....	7
3.3 QuickErase .....	7
3.4 Full Erase .....	8
3.5 Media Information.....	8
3.6 Set Language .....	8
3.7 System Information .....	8
3.8 SystemUpdate.....	9



## I. Introduction

This duplicator system is designed and developed based on the FPGA from the world famous semiconductor company XILINX. Every processing port is parallel to each other with its own control unit, therefore the duplicator will not sacrifice speed for the increasing number of targets loaded - always remain the same and fast copy speed. The duplicator supports fast copy with multiple file formats created by three major operating systems (Windows/Linux/MAC), and makes mirror copies of data efficiently. Furthermore, this duplicator has been fully tested with quality assurance before leaving our manufacturing facility.

### 1. Features

- Each processing channel has its own control unit and operates independently with dedicated bandwidth of up to 35MB per second.
- Standalone operation. No PC or software is required, minimizing possible computer virus infection.
- Instant power on and off, no warm-up or cool-down required.
- Easy-to-use One-Touch copy operation.
- Compare function available for verification of copy accuracy
- Menu options are user-friendly and easily accessed through the 4-button control panel. Use ▲ or ▼ button to scroll through the options and view the operation status of each channel on the 2-line backlit LCD display.
- Support Asynchronous copy mode for best operation efficiency.
- Powerful 32-bit CRC checksum to assure data integrity.
- Heavy-duty hardware construction for commercial production or personal use.
- 115V and 230V switching power supply maximizes portability for operation anywhere.
- Designed to save users time and effort in creating multiple copies quickly and reliably.
- Unique source data analysis to copy data area only to achieve highest efficiency
- Supports multiple file formats: Windows: FAT 16/32 、 exFAT 、 NTFS, Linux: Ext 2/3/4, Mac: HFS/HFS+, HFSX

## 2. Control Panel Overview

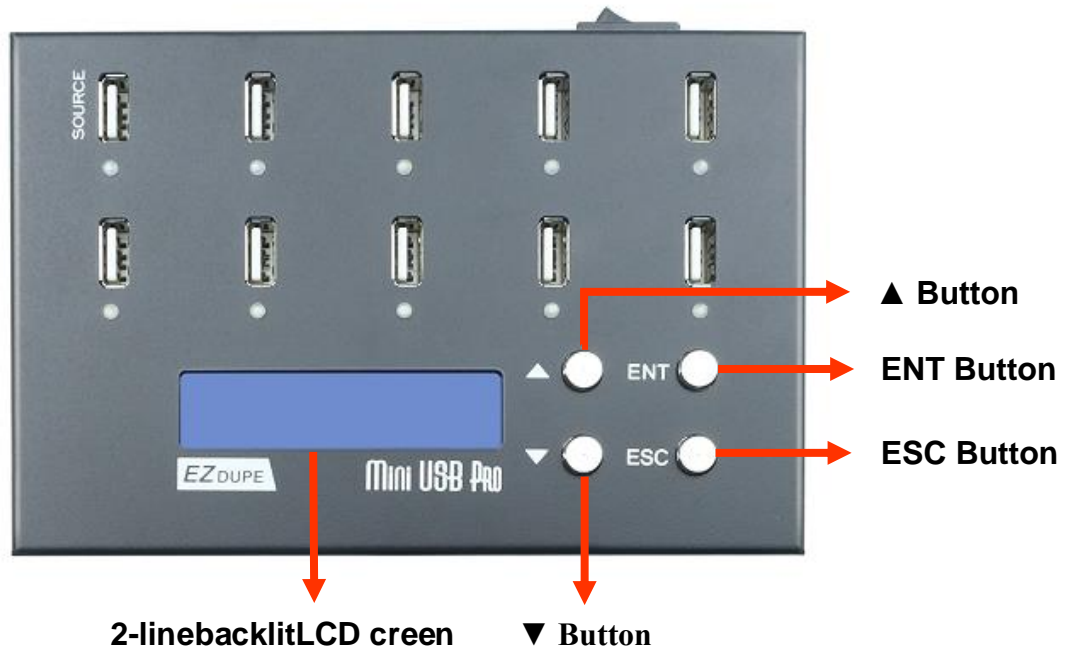

**▲ Button:** Up, Backward

**▼ Button:** Down, Forward

**ENT Button:** Enter, OK

**ESC Button:** Escape, Cancel



### 3. Specifications

<b>Operation</b>	Standalone (No PC or Software is required)	
<b>Target</b>	9	
<b>Copy Speed</b>	35 MB/S	
<b>Copy Mode</b>	Asynchronous	
<b>Copy Area</b>	System and Files (Intelligent Copy)	
<b>Supported Media</b>	USB Flash Drive 1.1/ 2.0/ 3.0/ 3.1	
<b>Display</b>	2-line Backlit Monochrome LCD	
<b>Supported Format</b>	FAT16,FAT32,exFAT,NTFS,ext2/3/4(Linux),HFS/HFS+(Mac)	
<b>System Memory</b>	128 MB DDR3	
<b>Power Adapter</b>	Input : AC 100-230V    Output : DC 12V/3A	
<b>Control Button</b>	4 push-button control panel (ENT, ESC, UP, DOWN )	
<b>Humidity</b>	Working	20% ~ 80%
	Storage	5% ~ 95%
<b>Temperature</b>	Working	41°F ~ 113°F (5°C ~ 45°C)
	Storage	-4 °F ~ 185°F (-20°C ~ 85°C)

## II. Warning

1. Source port is write-protected to prevent source data is erased accidentally.
2. The duplicator tasks mentioned in this user's manual are as following: Copy, Compare, Format, and Erase.
3. The Green LED flashes during the execution process of a task. After the task is done, the Green LED will stay solid if the process is successful, otherwise the Red LED will be on if the process is failed.
4. It is strongly recommended that the capacities of the source and target media are equal or similar.



### III. Asynchronous Operation

**Asynchronous Operation** is designed for the duplicator. It means that the duplicator will read the data from source device into system memory buffer and start to execute a task immediately when target device(s) inserted. Duplicator does not have to wait for all target device(s) inserted in order to start the execution of the task at the same time. No matter the data size of the source device, duplicator can asynchronously execute a task.

1. Insert source media into the source port, select the task to execute from the menu, and press ENT button. Duplicator will start to execute the task.
2. Target devices can be plugged in during the execution process, and will start to execute the task immediately
3. Target device can be removed when it finishes the execution process and its green LED is solid on. New target device can be plugged into the same port for execution of the task again.
4. LCD display will show the percentage of execution process, the number of successful and failed target(s). Here the percentage of execution process displayed is only for the least processed target device.
5. During the execution process, the status of each target device can be checked by using the ▲ and ▼ buttons.
6. After the task is done for all target devices, press ESC button to exit from the task. LCD display will show the total number of successful and failed target(s).
7. Each USB port executes the task asynchronously, doesn't need to wait for all target devices to be ready at same time.

## IV. Menu Overview

### 1. Copy

To copy from source device to target device(s) bit by bit and only copy available data area. When the source device reads fail, all target devices stop copying. When one of the target devices writes fail, it will stop copying.

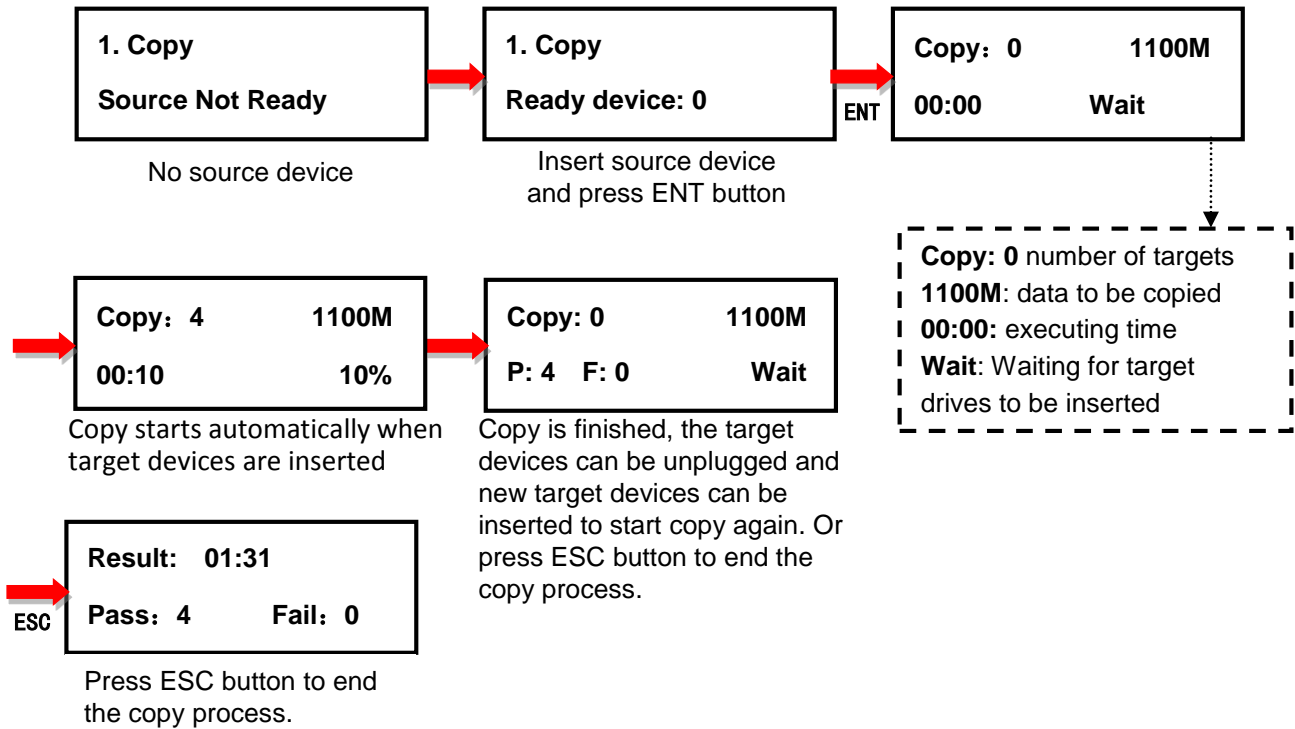

### 2. Compare

This command allows comparing the copied target devices against the source for accuracy.

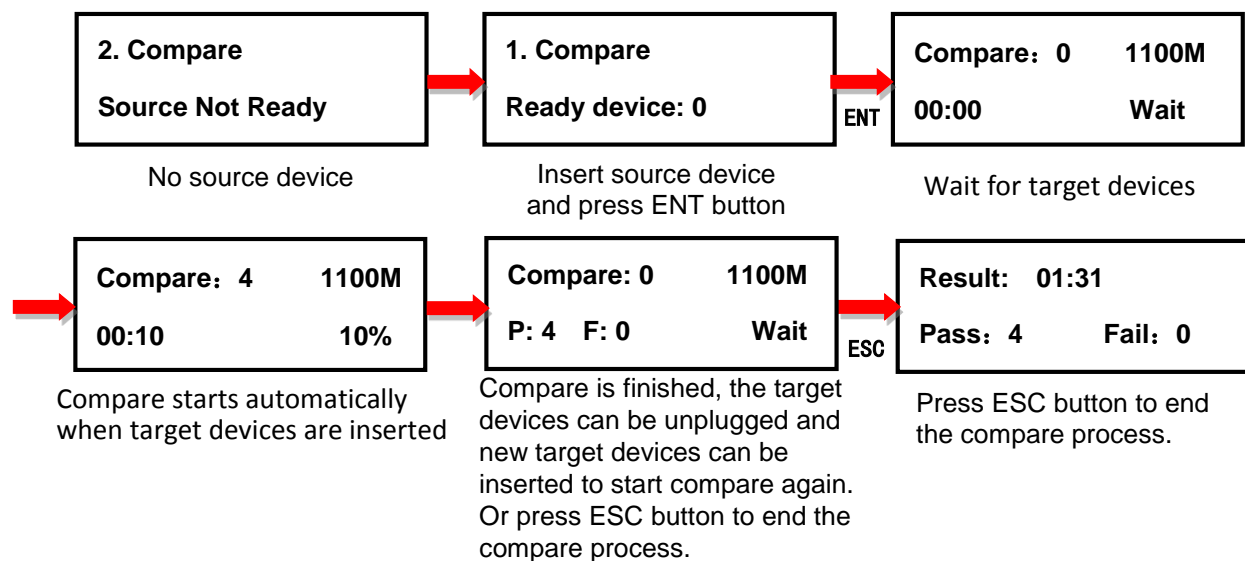

### 3. Utility

#### 3.1 Format FAT32

This option allows to format the target device to FAT32 file format. It will not format the source device, avoiding accidentally erasing the original data content.

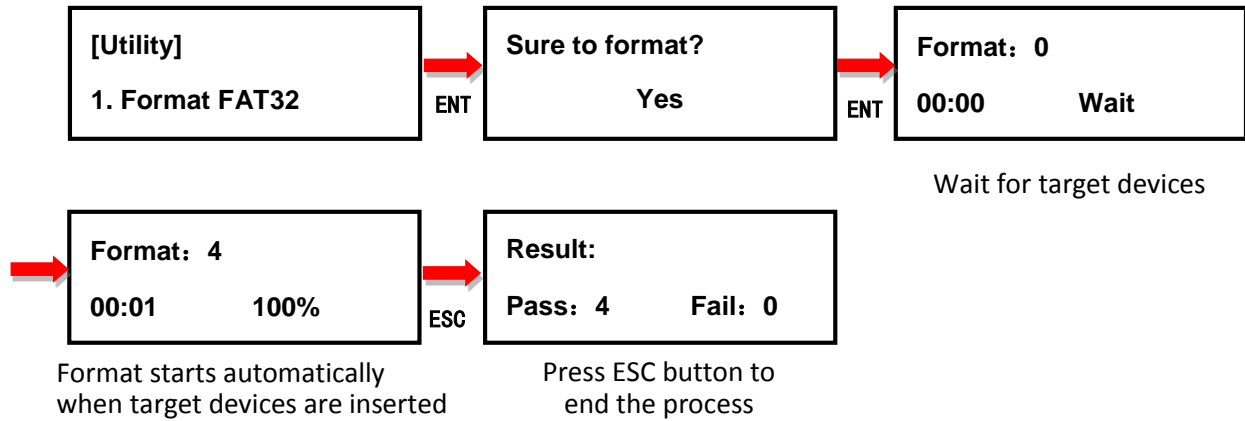

#### 3.2 Format exFAT

This option allows to format the target device to exFAT file format. It will not format the source device, avoiding accidentally erasing the original data content.

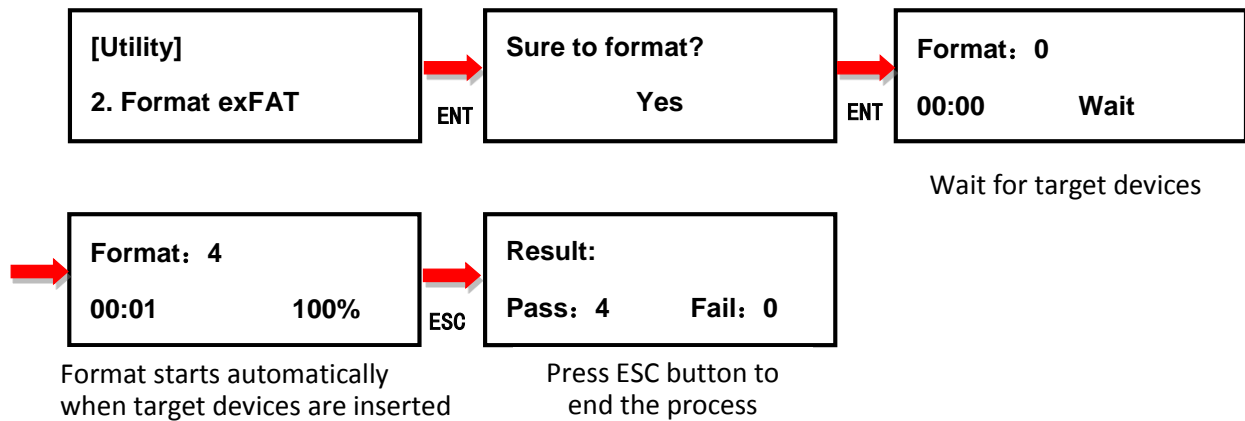

#### 3.3 Quick Erase

This option erases the table of content of file system of the target device.

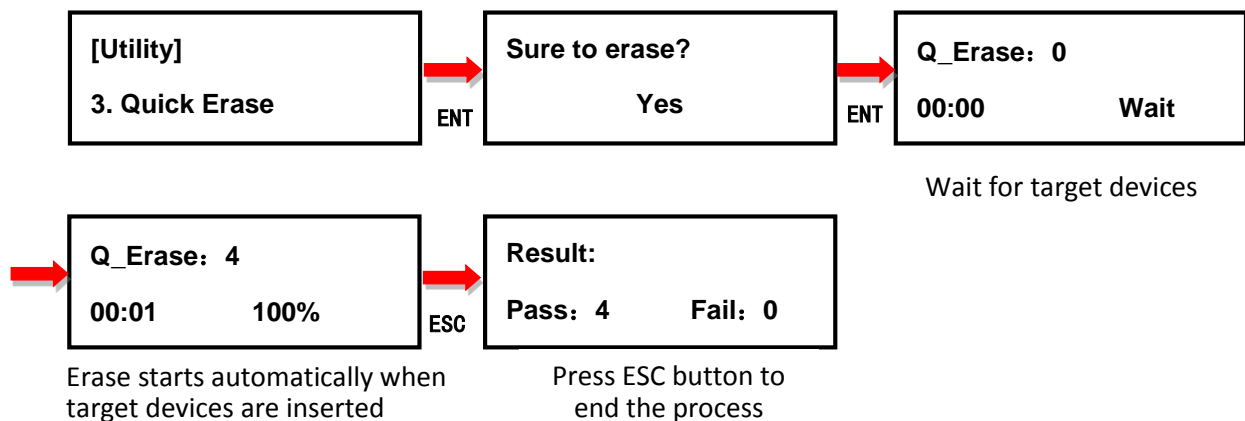



### 3.4 Full Erase

This option completely erases the content of target device.

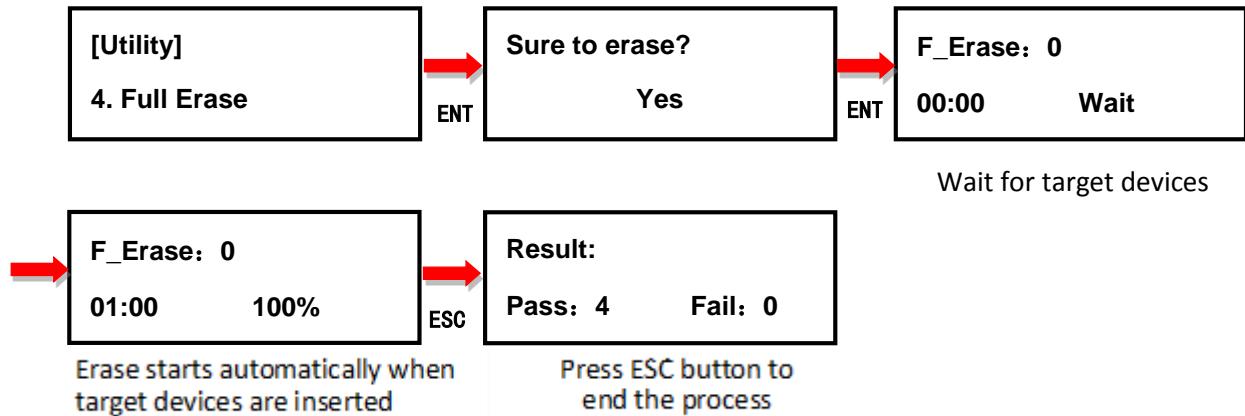

### 3.5 Media Information

This option displays the information of selected device media, such as total capacity, file format and the size of data content.

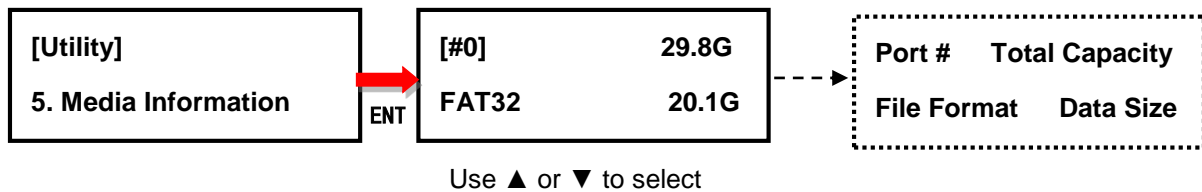

### 3.6 Set Language

This option allows choose the language for display: **English, Spanish, Portuguese, and Japanese**. English is the default language.

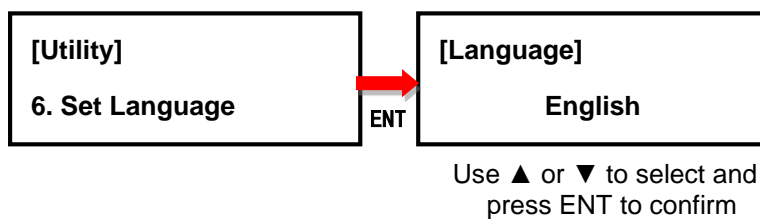

### 3.7 System Information

This option displays general information of the duplicator, including controller model, system memory size, firmware version and number of targets.

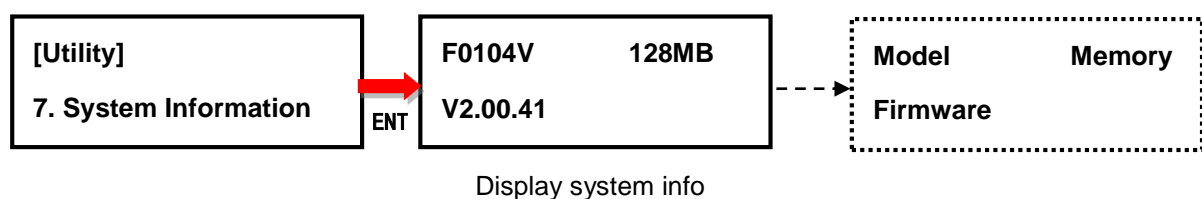

### 3.8 System Update

This option allows user to update the firmware of duplicator when necessary. Please obtain the proper firmware file from manufacturer, and save the unzipped file under home folder on the flash device (DO NOT save the file under sub folder). Insert the flash device containing the firmware into the source port of duplicator and press ENT. It will update the system, reboot the duplicator after update, and operate under the new firmware. **The file system of the flash drive must be FAT32.**

