

# Duplicator Quick Start Guide

## Step 1

Remove the unit from box and place it upright on a flat surface. Save packing material for storage and transport.



## Step 2

Before connecting the supplied AC power cord to the duplicator, check the input voltage switch setting to ensure that it matches the available voltage based on your location. Connect the AC Power cord to the unit and plug it into an AC wall outlet.

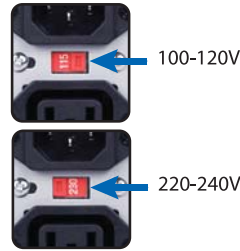

## Step 3

Turn on the unit by pressing the power button located on the front of the unit.

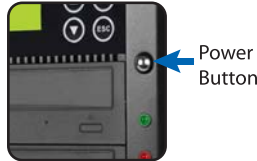

## Step 4

Upon powering up, the display on the LCD control panel will show "1. Copy Disc" indicating the unit is ready to operate.

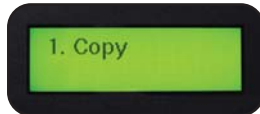

## Step 5

To begin the copying process, press the eject button on the top Master Drive (DVD/CD Reader Drive). When the tray opens, place the Master Disc in the tray & press the eject button to close the tray.



## Step 6

Press the eject button on the bottom DVD/CD writer drive(s). When the tray(s) open, place a blank recordable DVD/CD disc in the tray(s) and press the eject button to close the tray(s).



*(DVD/CD write drive must be loaded with blank recordable DVD/CD discs in each drive as necessary, depending on the number of copies required or until all drives are loaded.)*

## Step 7

After completing Steps 5 & 6, the copy process will automatically begin.

*(Copying status will be displayed on the LCD Screen. Press ENT if copying does not begin automatically.)*



## Step 8

Upon completion of the copy process, the completed discs will automatically be ejected. Remove completed discs and repeat steps 5-8 to continue the copying process as necessary.



## DVD/CD Duplicator Controls

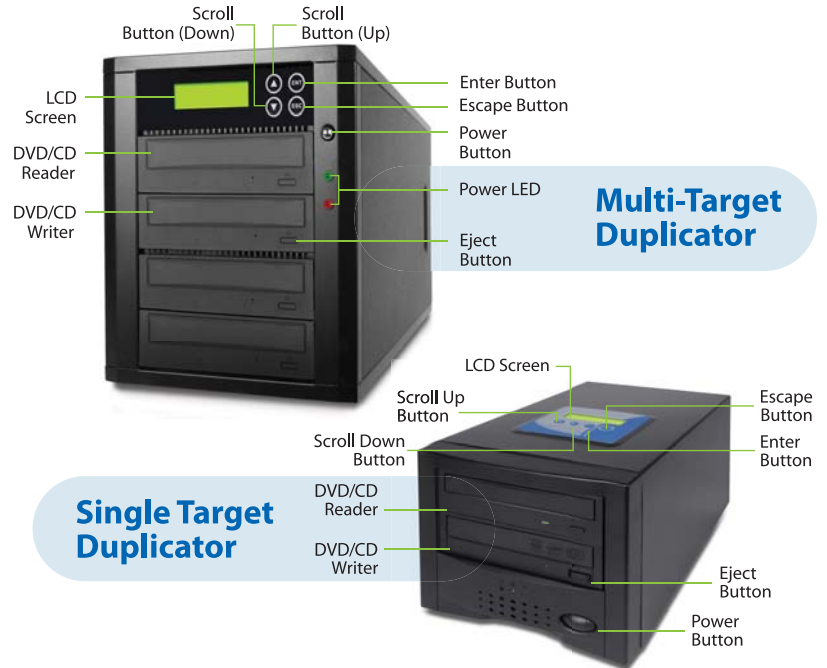

## Proper Packing & Unpacking

All units are packed with a sturdy outer box and added inner packing material in order to protect the duplicator from potential shipping damage.

### Step 1

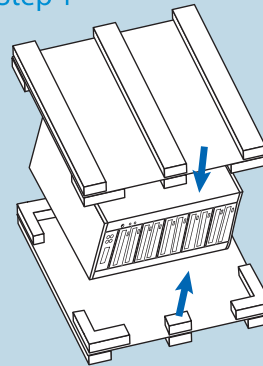

Double Sided PE Foam  
(Protects the duplicator on all sides)

### Step 2

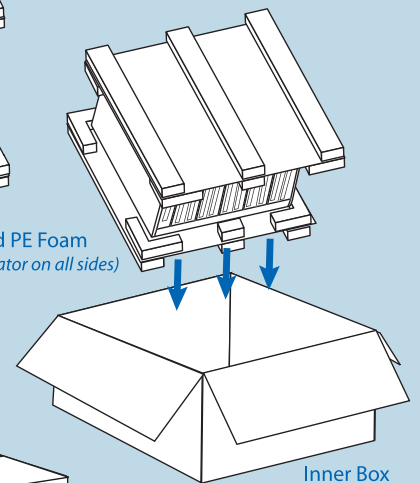

### Step 3

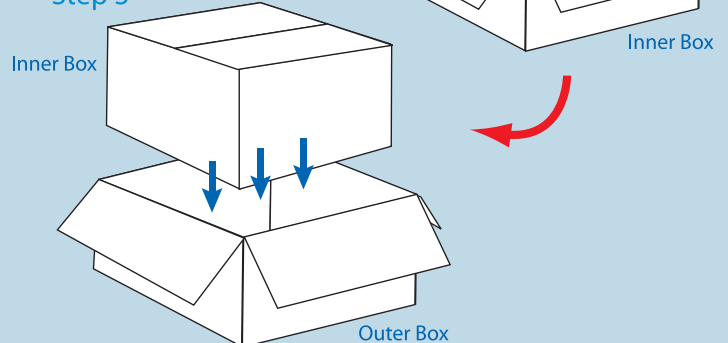

**NOTE:** Packing may vary depending on duplicator model.