

# Instruction

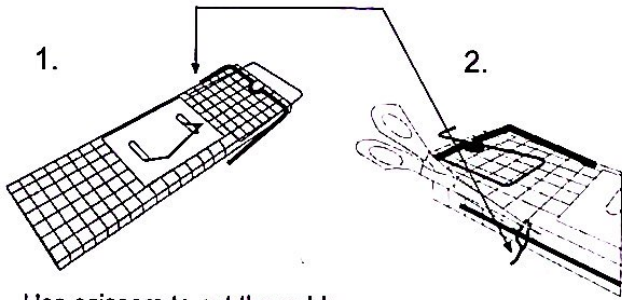

1. Use scissors to cut the cable.

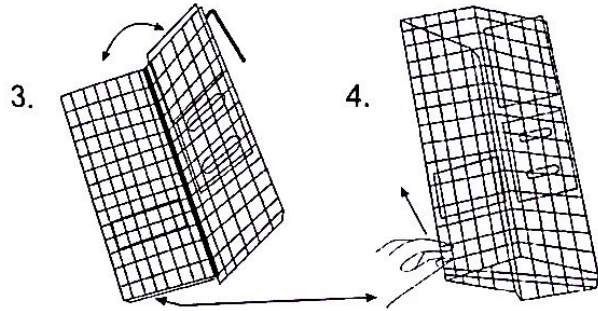

3. Flip the cage over to the right hand side and then lift the cage up.

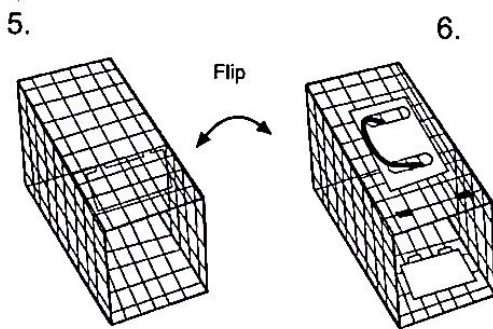

5. The cage should look like diagram 5. Its currently in an upside down position. Flip and turn the whole cage around so its the correct side up. You are now looking at the back of the cage.

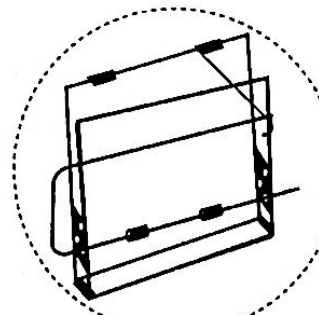
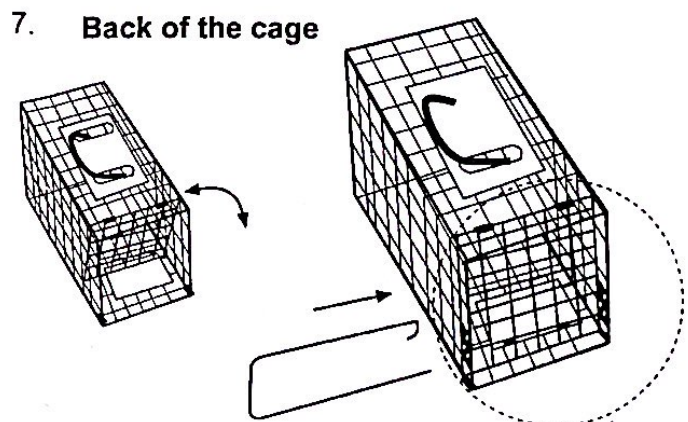

Pull the back plate down and lock in place, insert the short metal rod through the holes(dont forgot to hook the rod around the side of the cage)

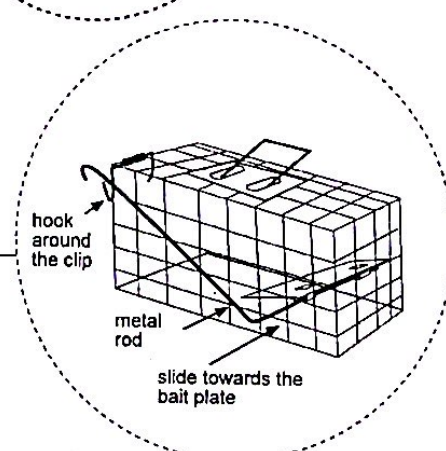
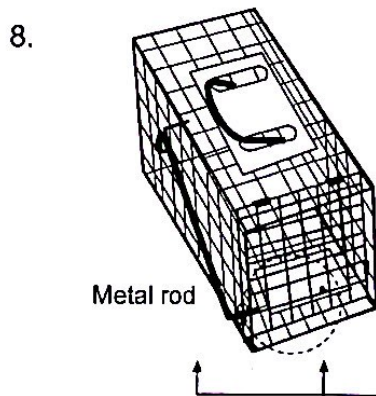

8. Front of the cage

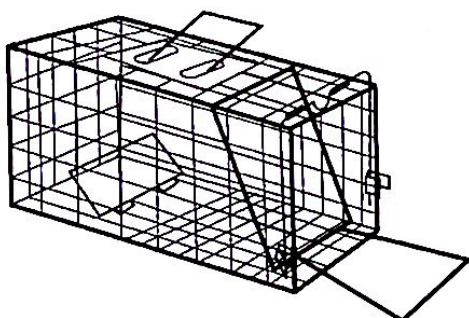

Slide the metal rod towards the bottom of the bait plate and then hook the rod around the clip. Setting up the back is now complete.

Turn the cage around so you are now facing the front of the cage.

9.

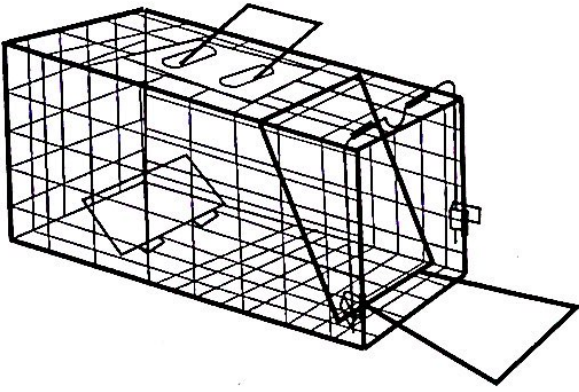

10.

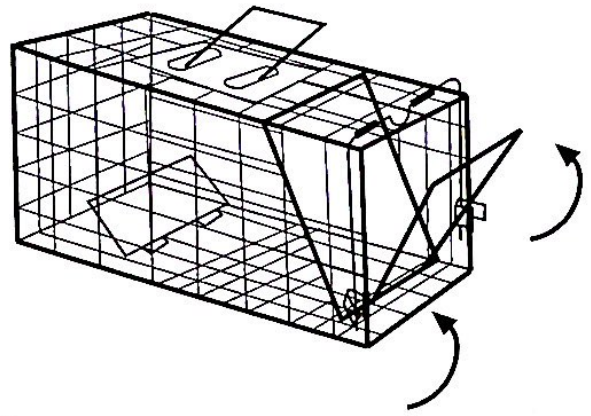

11.

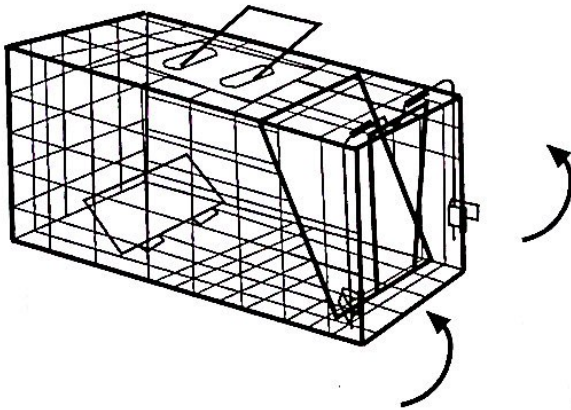

12.

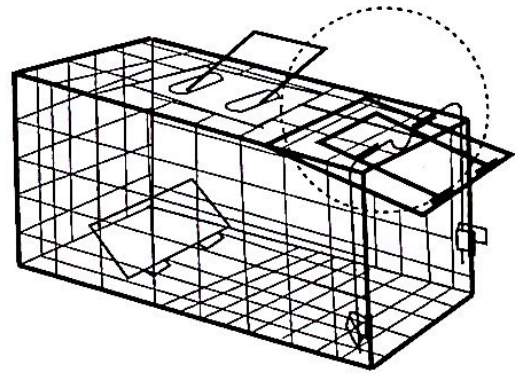

Lift the trap door spring and push towards the bait plate. Now is the time to place the baits behind the bait plate. Secure the metal rod using the metal folding tags already attached on the cage.

13.

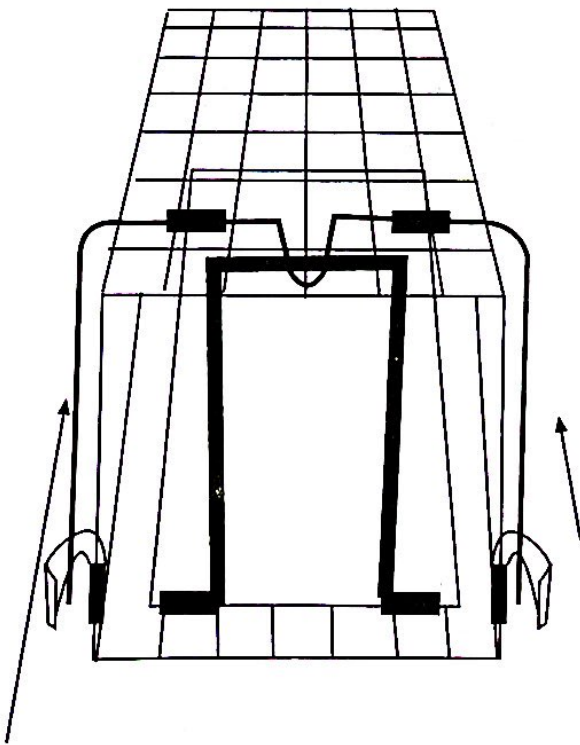

14.

Hold the trap door in open position, set the trap by swinging the setting hook beneath the bush on the trap door and then lowering the door to release pressure back onto the setting hook. The cage should look like diagram 14. Once set, the trap should be left in position for at least 7 days before relocating.

You can transport the cage using the carrier handles at the top of the trap.

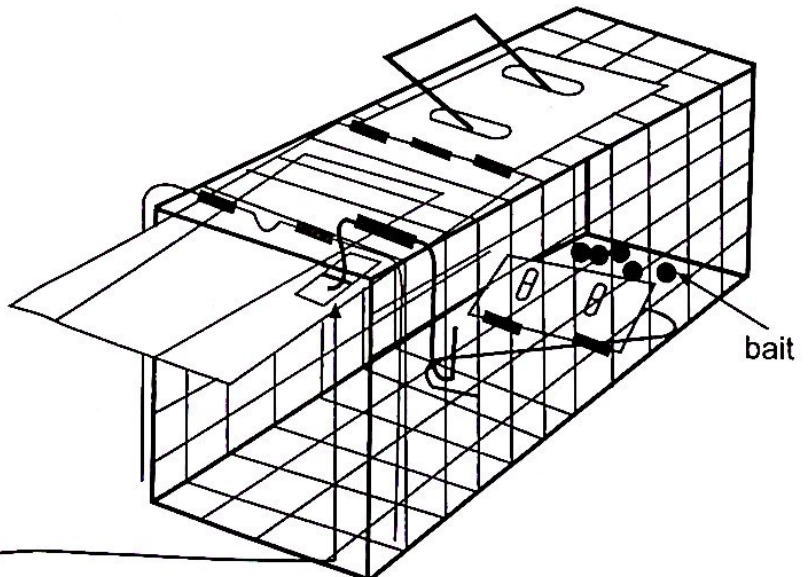

Setting Hook

bait