

Whisperwing

Installation Instructions

Contents

SECTION	PAGE
Whisperwing FAQ's	3
Whisperwing Installation Instructions	
35mm, 38mm and 44mm Doors	4
Timber Doors	6
Svelte	8
IBeam	10
Sliding Doors	11

Whisperwing FAQ's

Q: What is the Rw value for the Whisperwing Seal?

A: Rw35.

Q: What size is the backing of the Whisperwing Seal?

A: 6.9mm.

Q: What lengths are available to purchase?

A: 100 metre rolls or per lineal metre.

Q: What colours are available?

A: Whisperwing is available in black and grey.

Q: Does Whisperwing suit hinge and sliding doors?

A: Yes Whisperwing suits both hinge and sliding doors.

Whisperwing - 35mm, 38mm and 44mm Doors



Demonstration
of cutting the
Whisperwing Seal

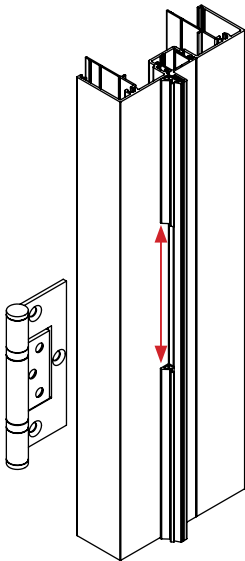

35mm Doors

To fix the hinge to
the door frame trim
the back leg of the
Whisperwing.

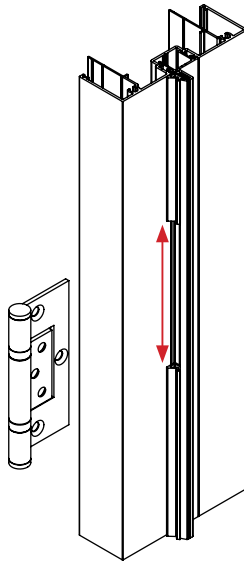

38mm Doors

To fix the hinge to
the door frame trim
the back leg of the
Whisperwing.

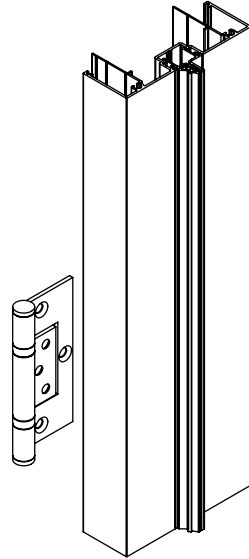

44mm Doors

To fix the hinge to
the door frame no
trimming of the
Whisperwing is
needed.

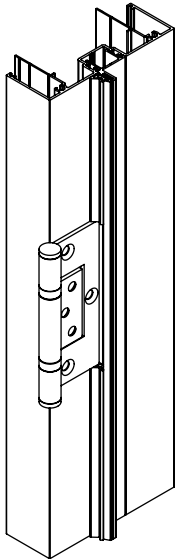

35mm Doors

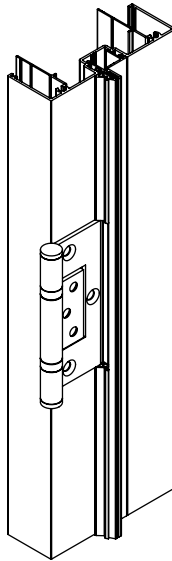

38mm Doors

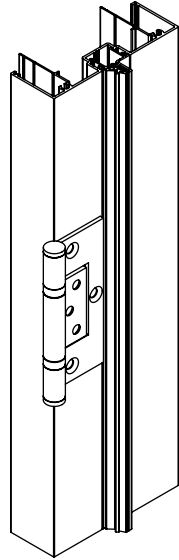

44mm Doors

Whisperwing - Timber Doors

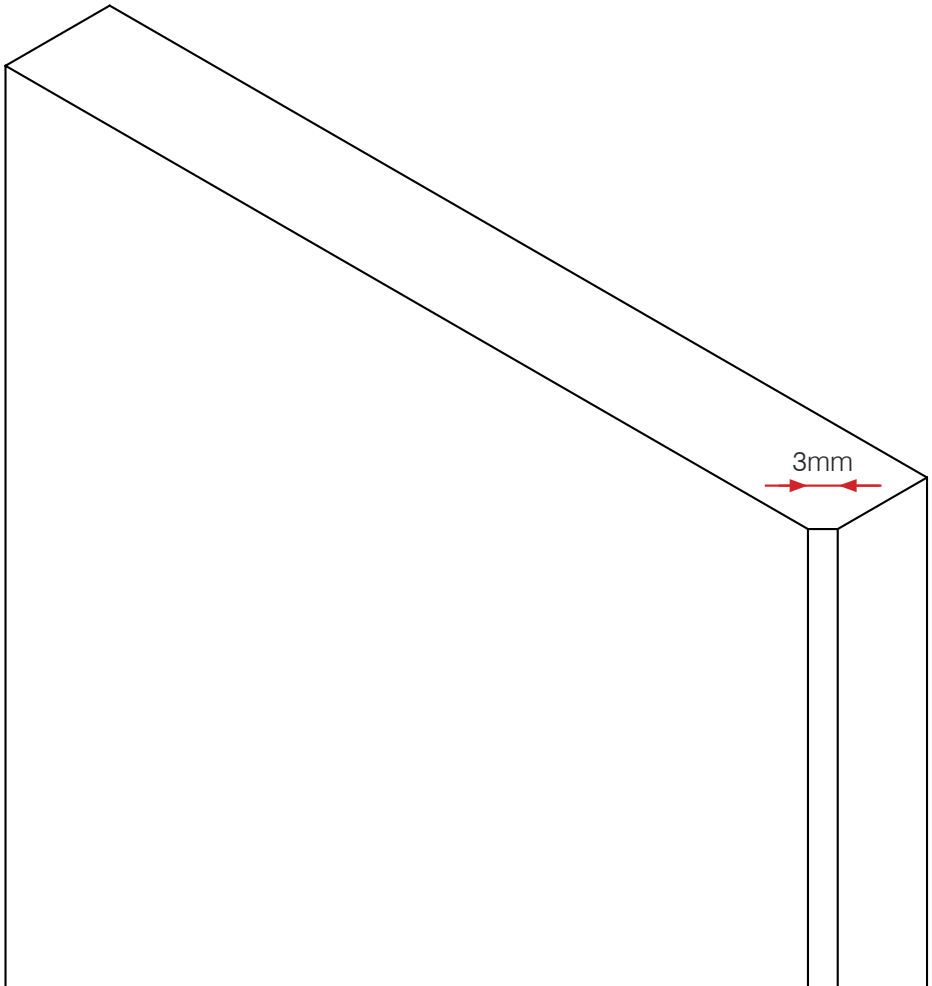

Timber Doors

When using timber doors, arris the edge of the hinge side of the door to ensure the door closes correctly.

Please note without an arrised edge on a timber door there will be conflict with the Whisperwing,

this will prevent a smooth closing finish.

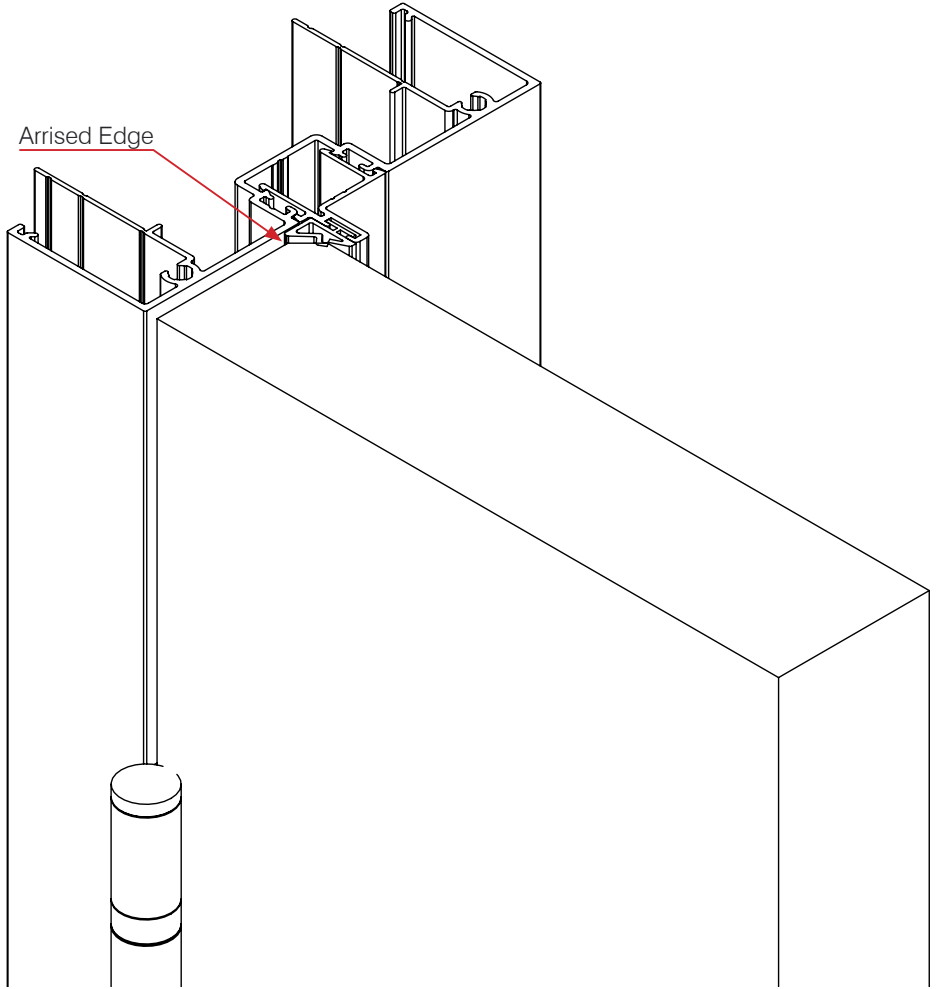

Whisperwing - Svelte



How to cut the
Whisperwing Seal.

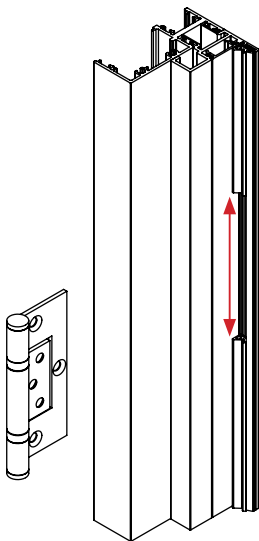

Svelte 75 Front Glaze Doors

To fix the hinge to
the door frame trim
the back leg of the
Whisperwing.

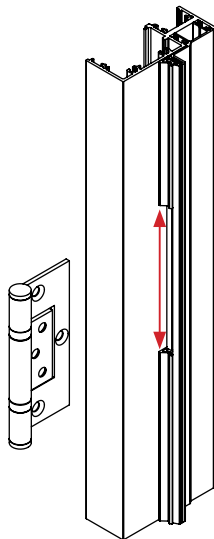

Svelte 75 Offset Glaze Doors

To fix the hinge to
the door frame trim
the back leg of the
Whisperwing.

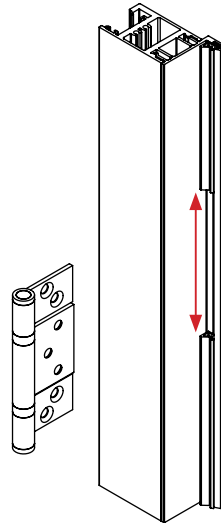

Svelte 33

To fix the hinge to
the door frame trim
the back leg of the
Whisperwing.

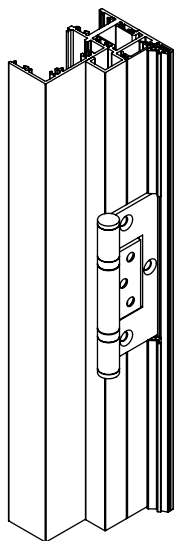

Svelte 75
Front Glaze Doors

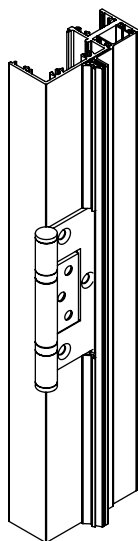

Svelte 75
Offset Doors

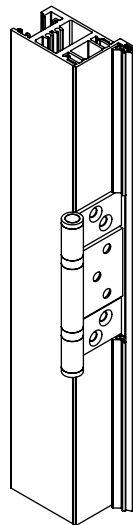

Svelte 33

Whisperwing - IBeam



How to cut the
Whisperwing Seal.

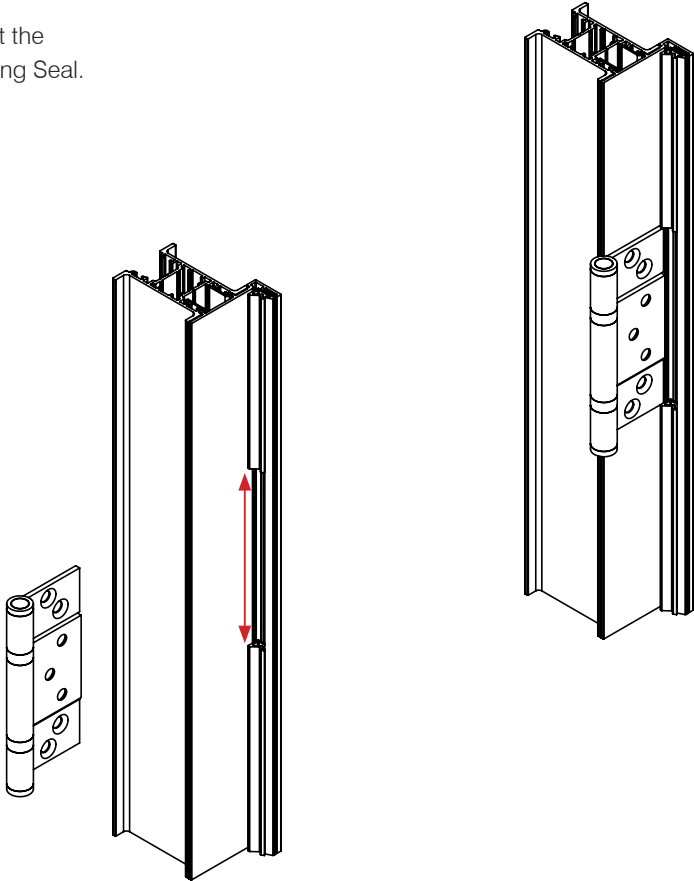

IBeam Doors

To fix the hinge to
the door frame trim
the back leg of the
Whisperwing.

Whisperwing - Sliding Doors

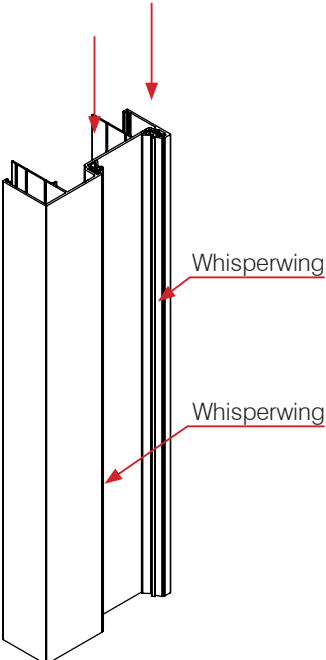

Sliding Doors

Slide Whisperwing into the seal provision of your selected receiver channel.

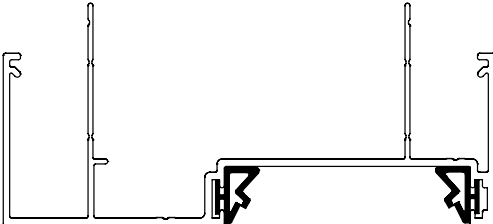



VIC

23 Scanlon Drive
Epping, VIC, 3076
T: 03 9355 0700

sales@criterionindustries.com.au

NSW

95 Victoria Street
Smithfield, NSW, 2164
T: 02 9355 0700

sales.nsw@criterionindustries.com.au

WA

58 Tacoma Circuit
Canning Vale WA 6155
T: 08 9355 0700

sales.wa@criterionindustries.com.au

QLD

22 Holt Street
Eagle Farm QLD 4009
T: 07 3193 8990

sales.qld@criterionindustries.com.au