



Definium 120

Plan and Elevation Views

DEFINIUM 120 - WALLS AND WINDOWS

ELEVATION VIEW

**Definium 120
Single Glaze**

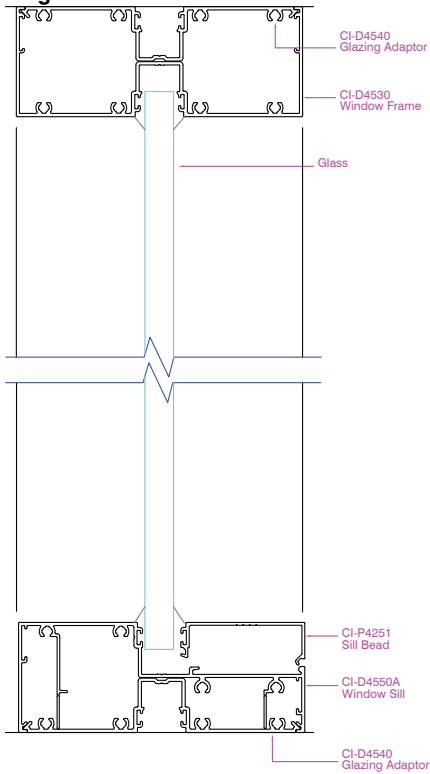

**Definium 120
Single Glaze Half Wall**

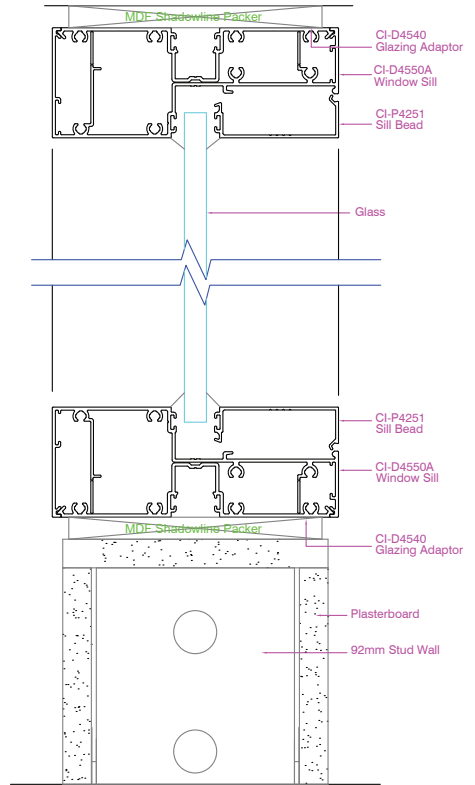

**Definium 120
Single Glaze using Sill Bead**

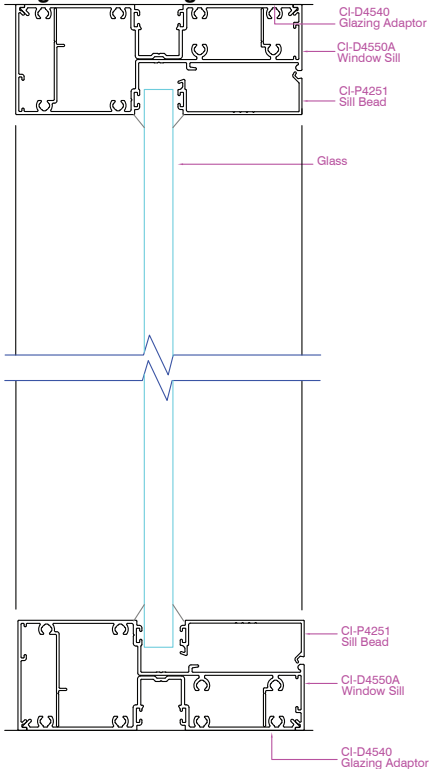

**Definium 120
Offset Glaze**

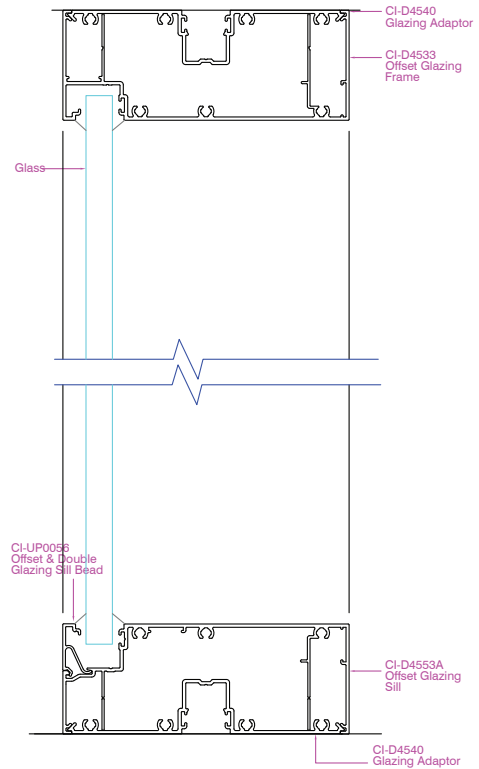

DEFINIUM 120 - WALLS AND WINDOWS

ELEVATION VIEW

Definium 120

Offset Glaze using Sill Bead

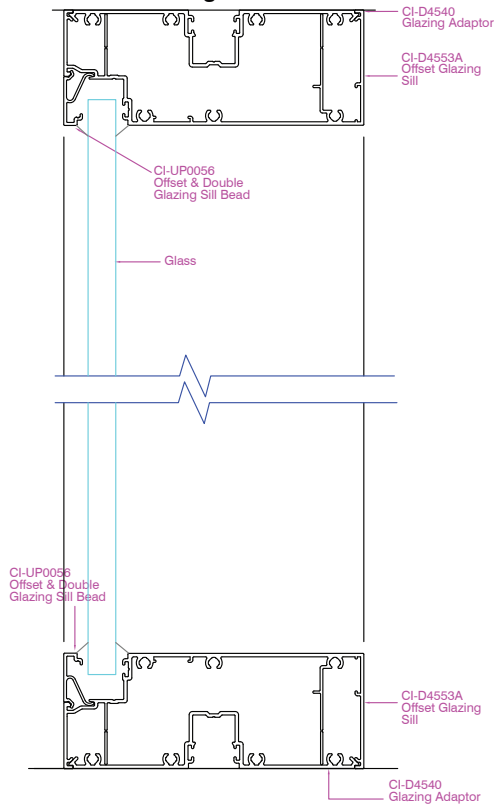

Definium 120

Double Glaze

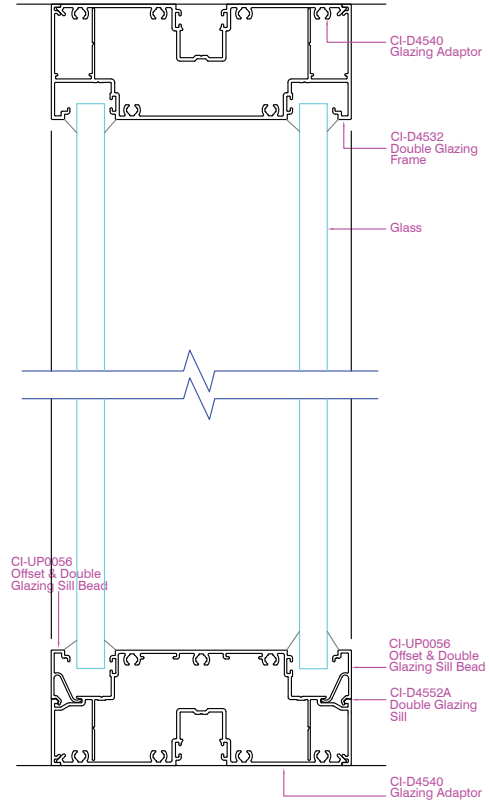

Definium 120

Double Glaze using Sill Bead

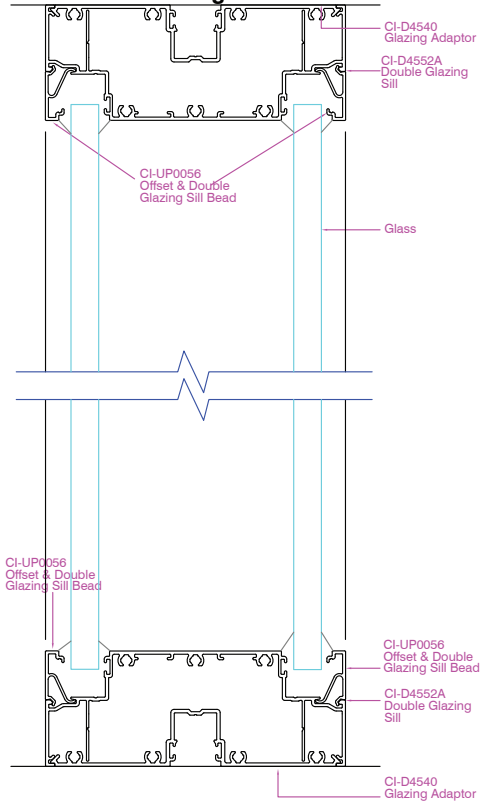

Definium 120

Plaster Wall with Shadowline

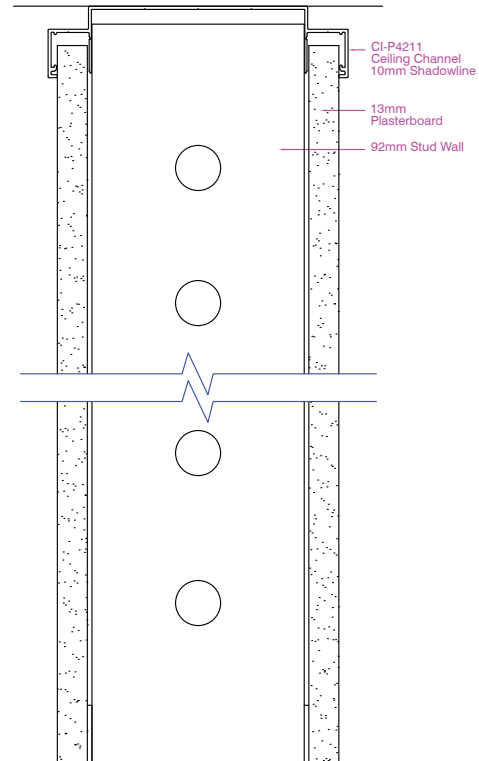

DEFINIUM 120 - WALLS AND WINDOWS

PLAN VIEW

Definium 120 Single Glaze

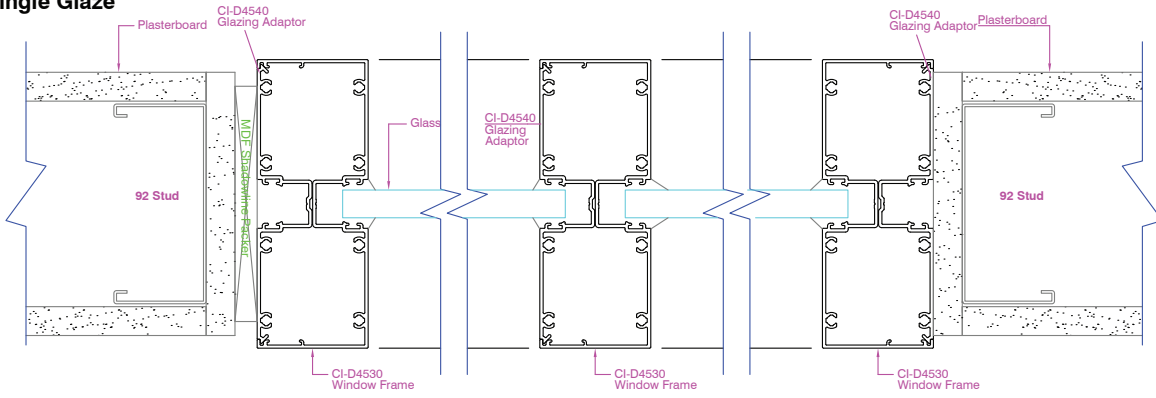

Definium 120 Offset Glaze

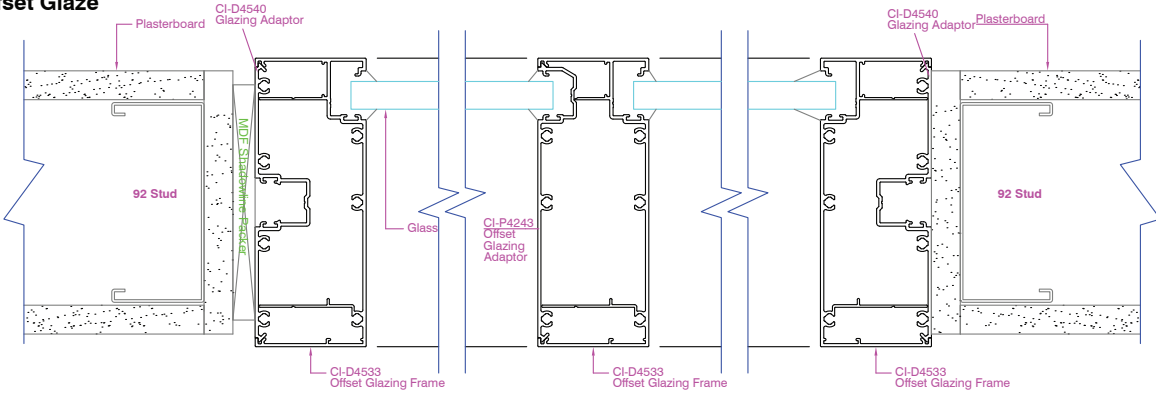

Definium 120 Double Glaze

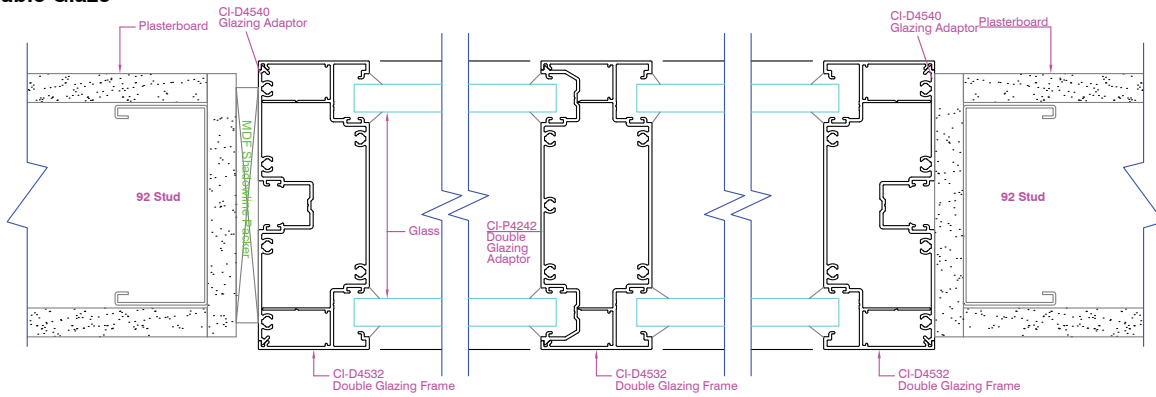

Definium 120 Single Glaze Sidelight and Door

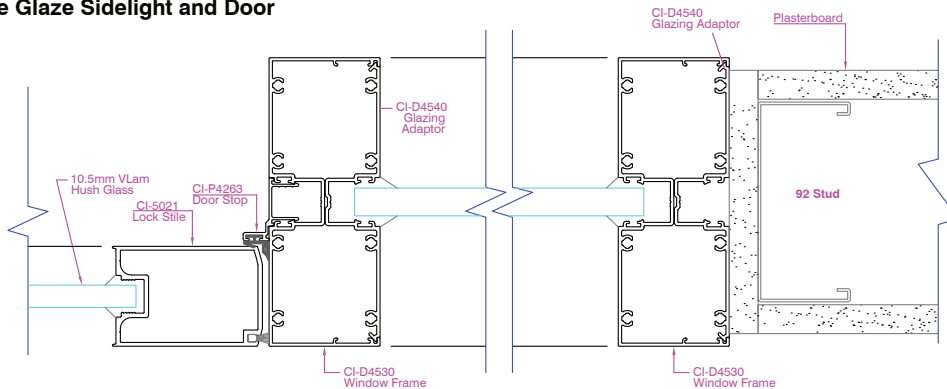

DEFINIUM 120 - WALLS AND WINDOWS

PLAN VIEW

Definium 120 Offset Glaze Sidelight and Door

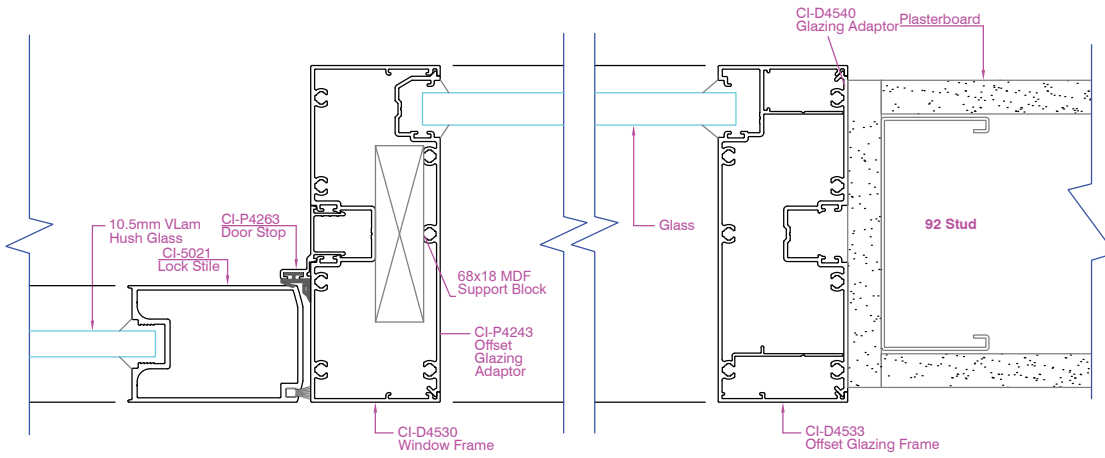

Definium 120 Double Glaze Sidelight and Door

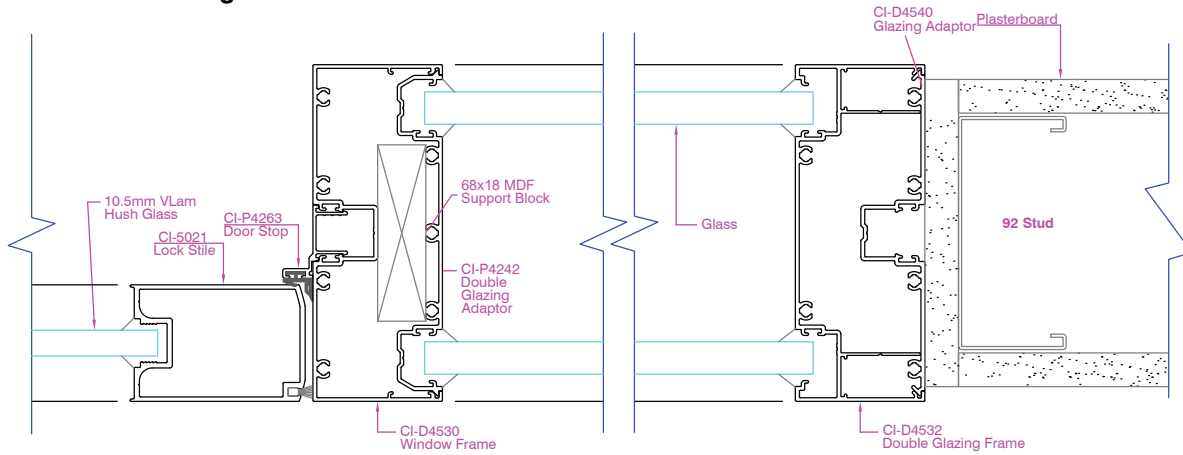

Definium 120 Plaster Wall with Shadowline / no Shadowline

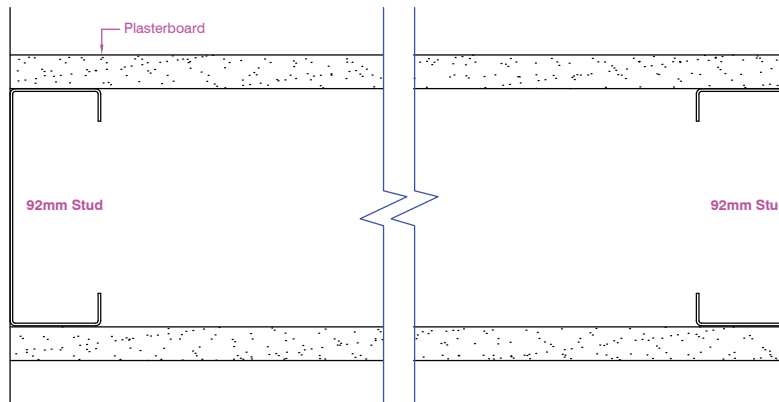

DEFINIUM 120 - DOORS

ELEVATION VIEW

**Definium 120
Timber Hinge Door**

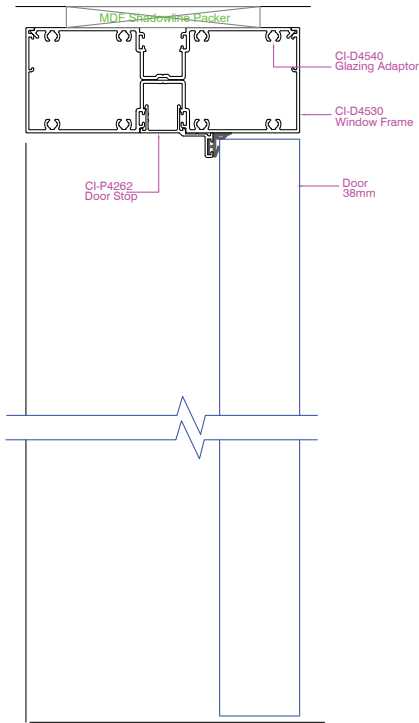

**Definium 120
Single Glaze with Sliding Door**

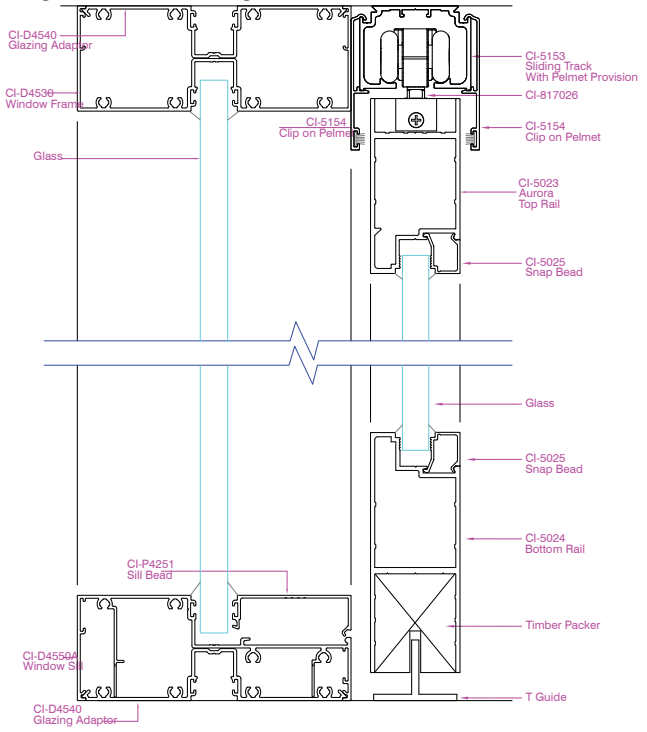

**Definium 120
Aluminium Hinge Door**

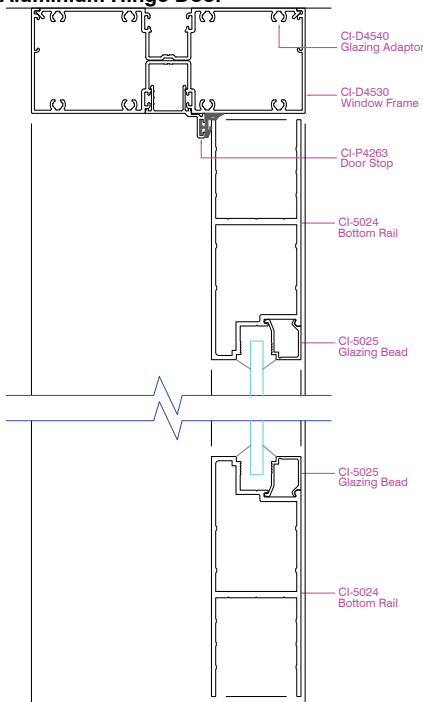

**Definium 120
Single Glaze with Sliding Door Bottom Track**

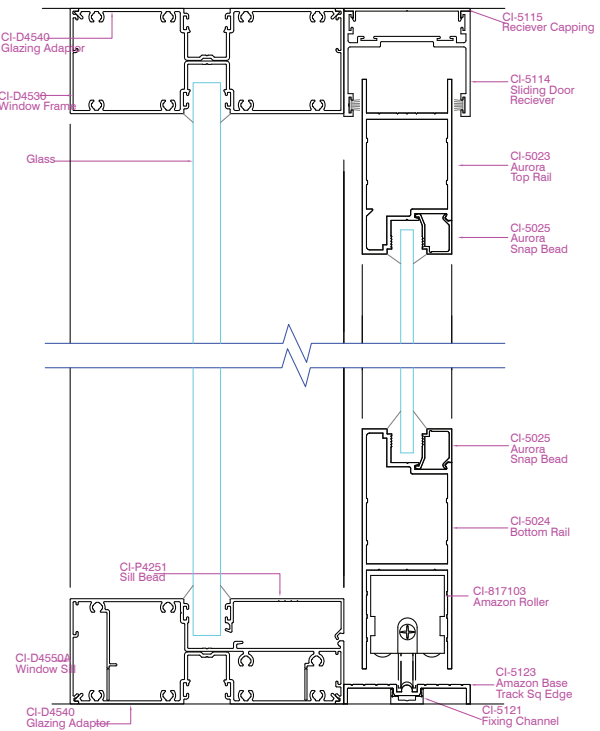

DEFINIUM 120 - DOORS

PLAN VIEW

Definium 120 Timber Hinge Door

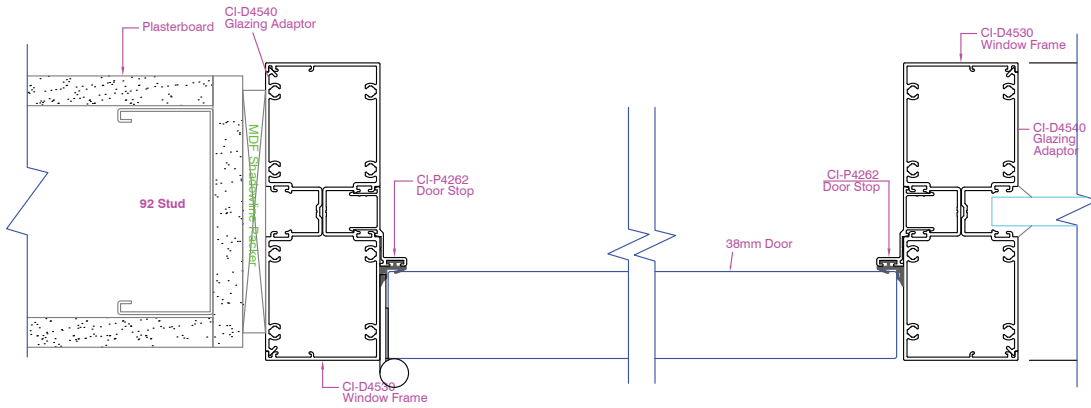

Definium 120 Aluminium Hinge Door

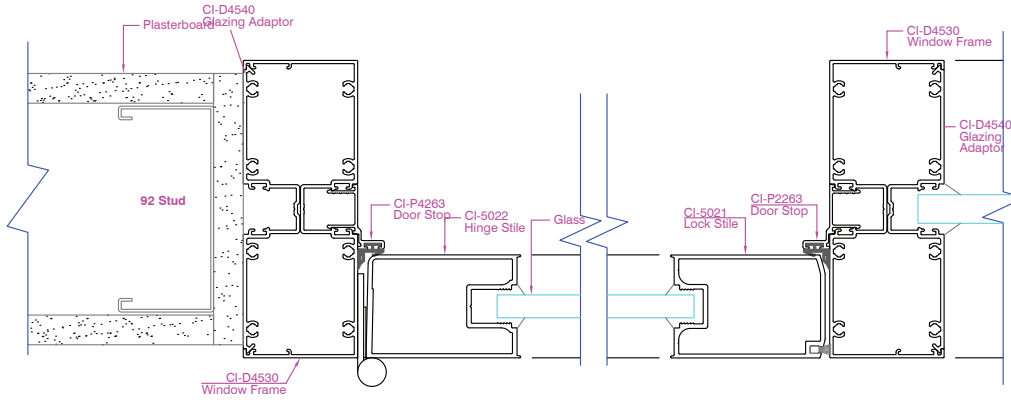

Definium 120 Aluminium Wide Hinge Door

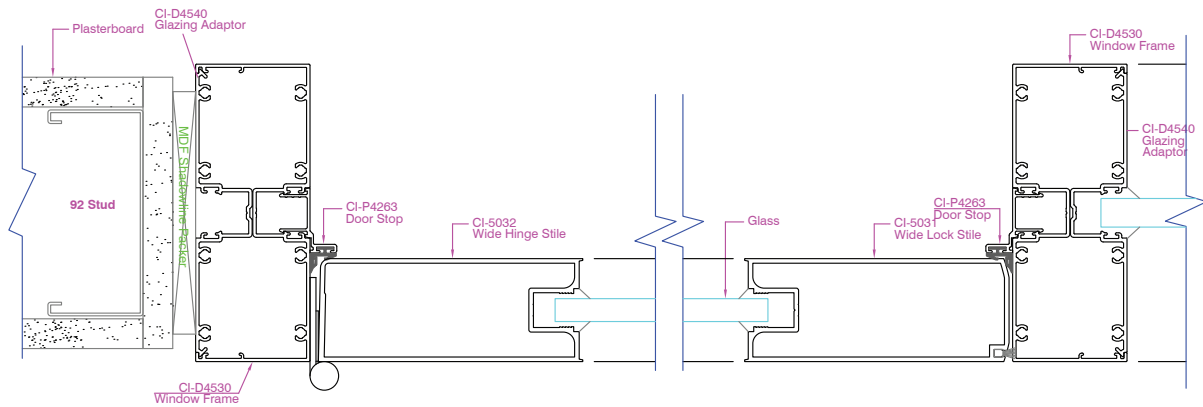

DEFINIUM 120 - DOORS

PLAN VIEW

Definium 120 Single Glaze with Sliding Door

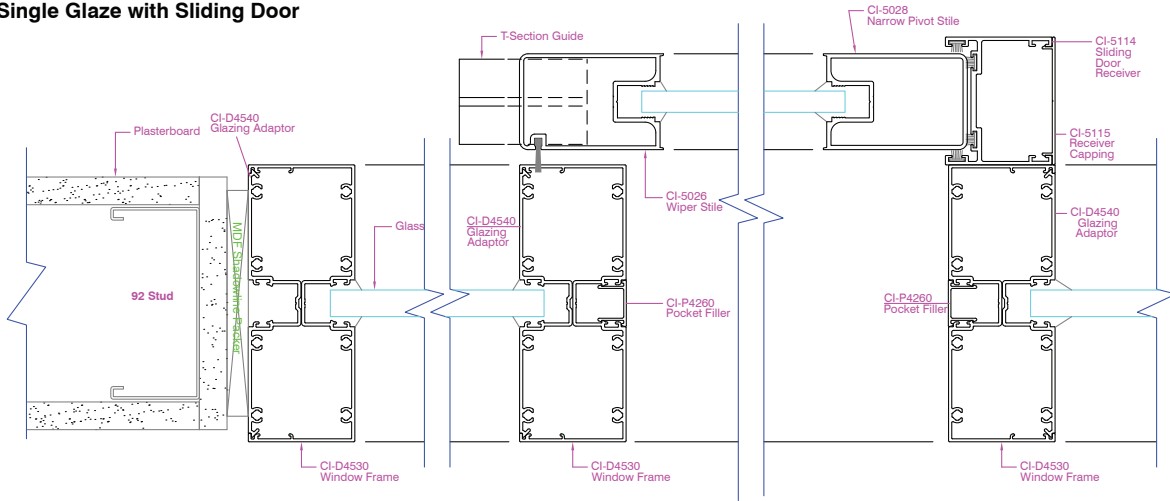

Definium 120 Single Glaze with Sliding Door Bottom Track

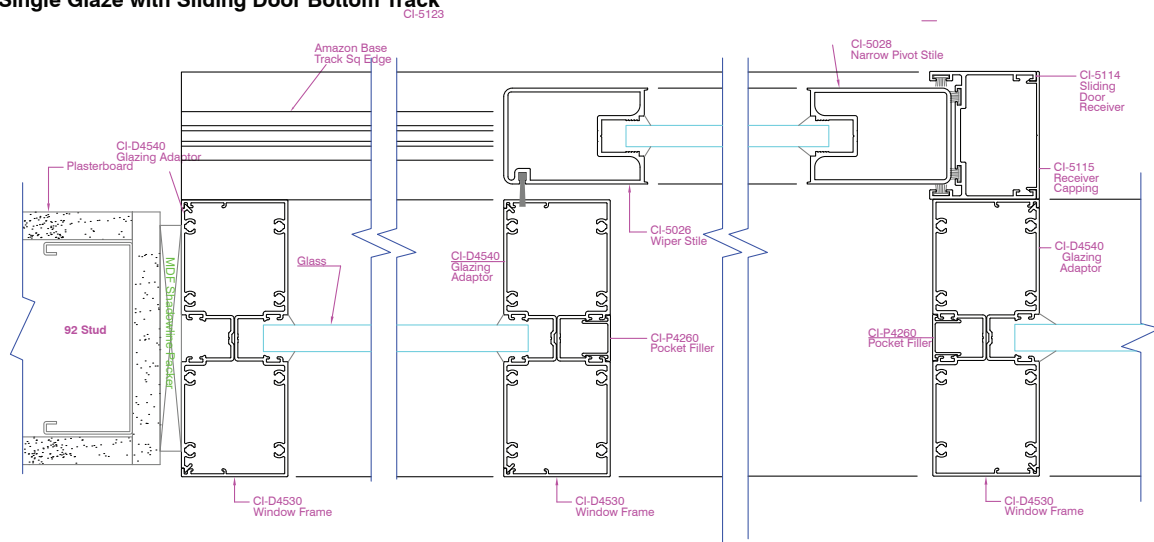



VIC

23 Scanlon Drive
Epping, VIC, 3076
T: 03 9355 0700

sales@criterionindustries.com.au

NSW

95 Victoria Street
Smithfield, NSW, 2164
T: 02 9355 0700

294-298 Norton Street,
Leichhardt, NSW, 2040
T: 02 9568 2988

sales.nsw@criterionindustries.com.au

WA

58 Tacoma Circuit
Canning Vale WA 6155
T: 08 9355 0700

sales.wa@criterionindustries.com.au

QLD

22 Holt Street
Eagle Farm QLD 4009
T: 07 3193 8990

sales.qld@criterionindustries.com.au

www.criterionindustries.com.au