

# Opti-Lite® Door Vision Panel

A Vision  
Of Safety

☎ 1300 754 337

🖱 [www.criterionindustries.com.au](http://www.criterionindustries.com.au)

 **Criterion**





## Introducing the Opti-Lite<sup>®</sup> Door Vision Panel.

Safety must always be a key priority when building and designing commercial and residential spaces.

The Criterion Opti-Lite<sup>®</sup> Door Vision Panel is an innovative installation solution, designed to be installed in both new and existing doors. The Opti-Lite<sup>®</sup> Door Vision Panel allows for visual sightings and natural light into a workspace and is fully tested and certified to comply with AS1288, which creates for safer workplaces and residential spaces.

For more detailed information on the advantages of the Opti-Lite<sup>®</sup> Door Vision Panel visit [www.criterionindustries.com.au](http://www.criterionindustries.com.au) or call 1300 754 337.

# Improved style. Enhanced safety.

Manufactured and engineered with a durable metal secure fixing clip, the Opti-Lite® Door Vision Panel is easy-to-install and is a more affordable option than replacing existing doors on site.





The Opti-Lite® Door Vision Panel also features a pre-glazing design concept that saves installation time and eliminates the need to complete the tedious process associated with traditional glazing.

The Opti-Lite® Door Vision Panel can be installed in both internal and external applications and is available in a variety of sizes and shapes.

## Key Features

- Glazed in 6.38mm clear safety laminate for extra security & durability.
- Suits a wide range of door thicknesses – 32mm - 48mm.
- Available natural and anodized finish.
- Can be manufactured to suit specific customised requirements (including, size, colour and class type).

## Ideal installation locations

-  Schools
-  Sporting facilities
-  Offices and commercial spaces
-  Cafés/ restaurants
-  Bathroom entrances



Before (top) and after (bottom) Opti-Lite® Door Vision Panel installation

# Stock specifications sizes

Opti-Lite® Door Vision Panels are available in a wide range of stock sizes including:

Custom sizes are available on request. (Please note, the door panels are designed to fit into the actual cut out sizes listed below.)

**300 x 200**

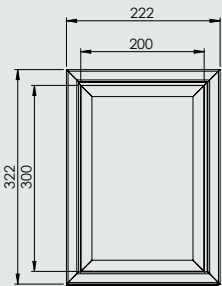

**600 x 200**

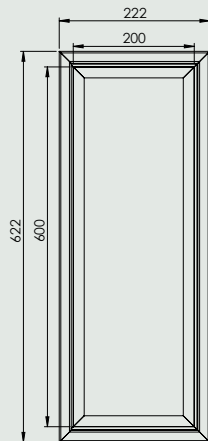

**900 x 200**

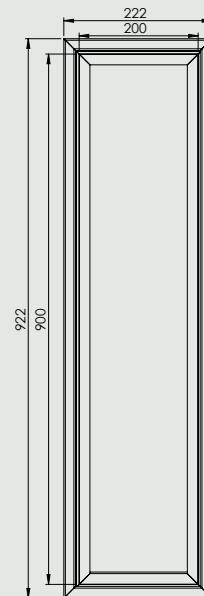

**1700 x 200**

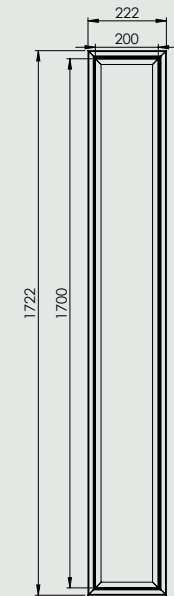

**600 x 300**

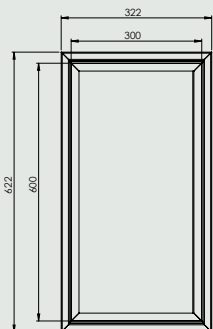

**600 x 600**

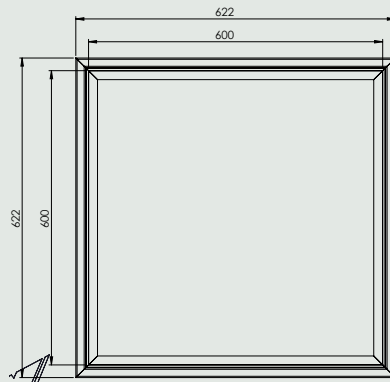

**900 x 600**

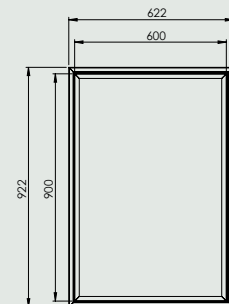

**Opti-Lite® Door Vision Panel**

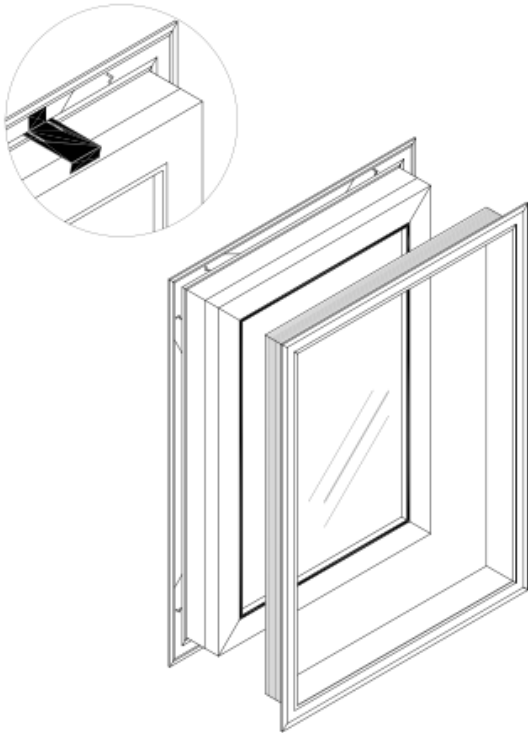

**Opti-Lite® Installation Instructions**

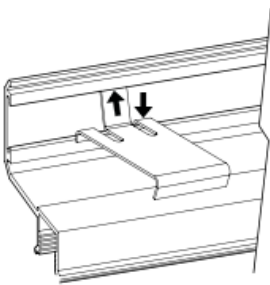

**Step 1.**

Insert clip so that middle tab fits into upper groove and one side tab fits into lower groove.

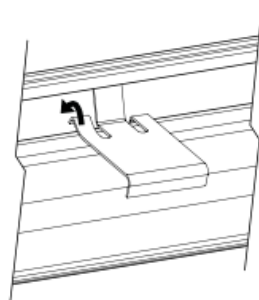

**Step 2.**

Pry second side tab into lower groove using screw driver.

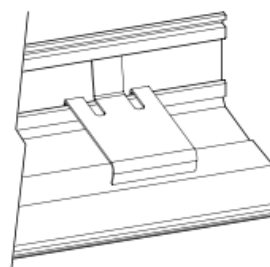

**Step 3.**

Ensure clip is installed correctly and repeat for all clips provided. Space clips proportionally on all four sides.

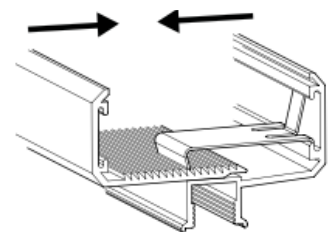

**Step 4.**

Place front frame into opening and press back frame into position from opposite side of the door, ensuring clips catch as shown.

**Note**

Using Silicon to seal to inside of flange will prevent movement within opening after installation. Removing the Opti-Lite® Door Vision Panel after installation may result in damage to the clips and possibly the frame.



# Convenience and safety combined.

Looking to discover more?

Contact us to book your  
free demonstration:

☎ **1300 754 337**

🖱 **[www.criterionindustries.com.au](http://www.criterionindustries.com.au)**



## **VIC**

23 Scanlon Drive  
Epping, VIC, 3076  
T: 03 9355 0700

[sales@criterionindustries.com.au](mailto:sales@criterionindustries.com.au)

## **NSW**

95 Victoria Street  
Smithfield, NSW, 2164  
T: 02 9355 0700

[sales.nsw@criterionindustries.com.au](mailto:sales.nsw@criterionindustries.com.au)

## **WA**

58 Tacoma Circuit  
Canning Vale WA 6155  
T: 08 9355 0700

[sales.wa@criterionindustries.com.au](mailto:sales.wa@criterionindustries.com.au)

## **QLD**

22 Holt Street  
Eagle Farm QLD 4009  
T: 07 3193 8990

[sales.qld@criterionindustries.com.au](mailto:sales.qld@criterionindustries.com.au)