

IBeam

**A slimline
industrial style.**

www.criterionindustries.com.au





IBeam

The IBeam suite is a slimline partition system designed to add an industrial aesthetic to retail or commercial fit outs. Inspired by an appreciation for exposed structural elements, the IBeam suite was developed to create a bold partition system with strong definition.

Available in a wide range of powder coated colours, the IBeam suite's industrial slimline look will allow for a sophisticated interplay of raw and refined in your next design. Create a focal point in your next design and turn a structural element into a showpiece with the IBeam Partition System.

Designed with an adaptable frame, the IBeam suite can stand-alone and has the flexibility to be installed at various stages of a project – including after plasterwork completion.

With a universal glazing pocket, the IBeam suite complies with the AS1288 glazing code for glass up to 12.8mm thick.

WHY CHOOSE IBEAM?

- + **40mm reveal**
- + **Slimline Glazing available**
- + **Simple Installation**
- + **Suits up to 12.8mm glass**
- + **Top hung IBeam sliding track suits Arctic Low Clearance Roller**
- + **Suits timber or IBeam doors**
- + **Acoustic Ratings:**
 - IBeam Single Glaze – RW36

PRODUCT RANGE

IBeam
IBeam Sliding Track
IBeam Doors





IBeam

IBeam - 100 CREEK ST, BRISBANE

FEATURES



Sliding Track

The IBeam Sliding Track integrates with the Arctic Roller to create a tiny 4mm clearance between the top of the door and the sliding track, delivering a low-clearance, soft-close finish for sliding doors.

IBeam Door Handle

A custom designed handle specifically to suit the IBeam system.

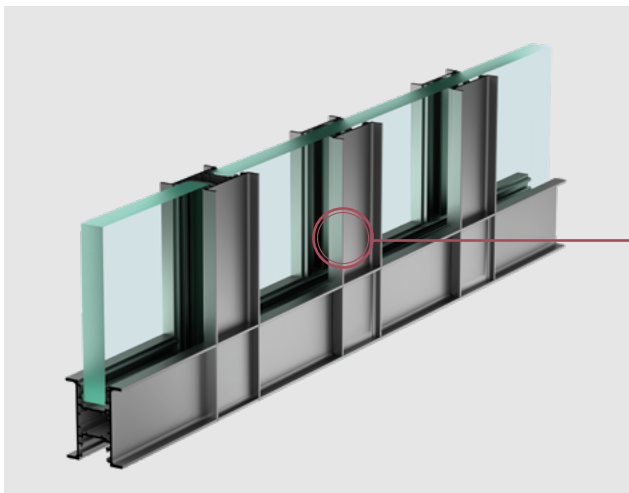
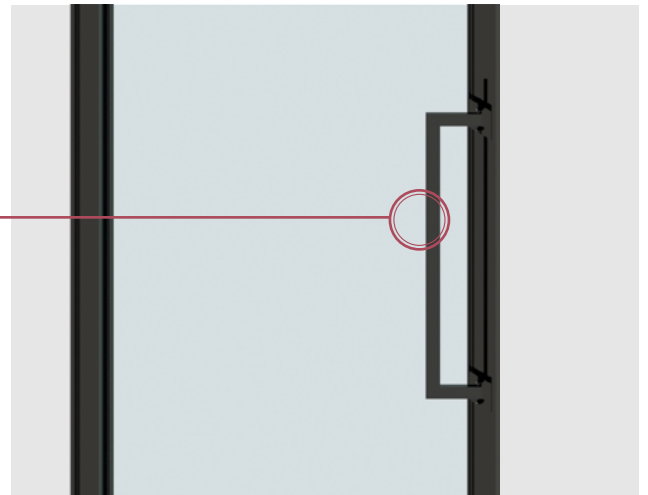

Stick-on Mullion Beam

The IBeam Suite features a Stick-On Mullion which can be used with double-sided tape to create a stylish framed glass look with minimal glazing.

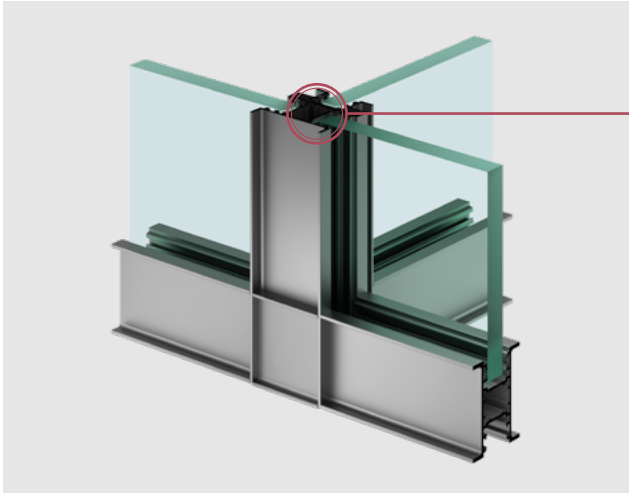

T Junction

The IBeam T-Junction enables three-way glazing options.

Receiver Channel

The IBeam Receiver Channel continues the overall IBeam aesthetic.

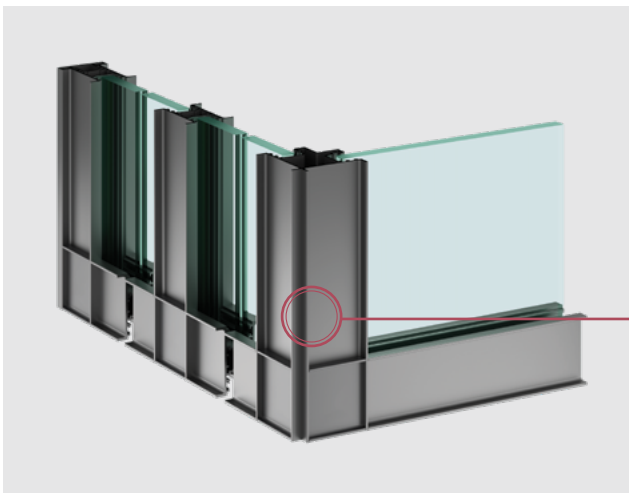
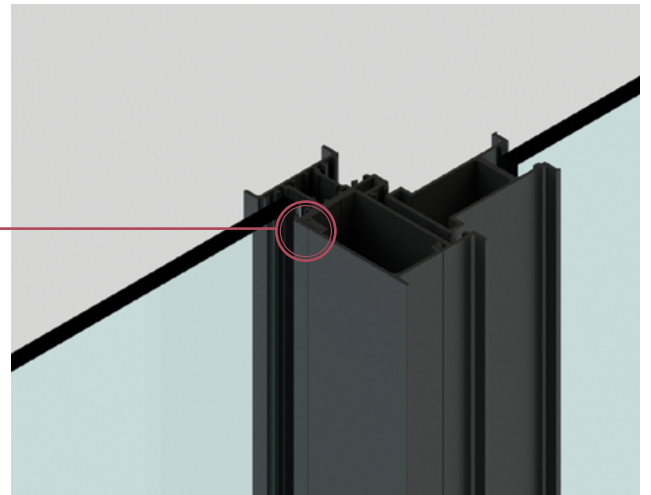

Corner Detail

The IBeam Corner Detail replicates the function of three separate profiles.

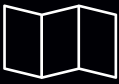

SECTION IMAGE	DESCRIPTION	LENGTH	CODE
	CI-0530 Window Frame	2800mm	053028
		6500mm	053065
	CI-0550 Window Sill	3700mm	055037
	CI-0551 Sill Bead	3700mm	055137
	CI-0578 2 Way Corner Post	2800mm	057828
		6500mm	057865
	CI-0540 3 Way Adaptor	2800mm	054028
	CI-0582 Stick On Mullion	6500mm	058265
	CI-0562 Door Stop	2800mm	056228
		6500mm	056265
	CI-0560 Pocket Filler	2800mm	056028
		6500mm	056065
	CI-P4260 Pocket Filler	2800mm	P426028
		6500mm	P426065

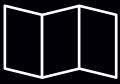

IBEAM SLIDING SYSTEM

SECTION IMAGE	DESCRIPTION	LENGTH	CODE
	CI-0526 Track Mounting Bracket	2800mm	052628
		6500mm	052665
	CI-0553 Sliding Track	3700mm	055337
		6500mm	055365
	CI-0541 Pelmet	3700mm	054137
		6500mm	054165
	CI-0514 Sliding Door Receiver	2800mm	051428
		6500mm	051465
	CI-0515 Receiver Capping	2800mm	051528
		6500mm	051565
	CI-0531 Acoustic Split Jamb	2800mm	053128
		6500mm	053165
	CI-P4260 Pocket Filler	2800mm	P426028
		6500mm	P426065
	CI-0530 Window Frame	2800mm	053028
		6500mm	053065
	CI-0550 Window Sill	3700mm	055037
	CI-0551 Sill Bead	3700mm	055137

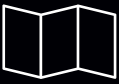

IBEAM DOORS

SECTION IMAGE	DESCRIPTION	LENGTH	CODE
	CI-0524 Door Rail	6500mm	052465
	CI-0528 Door Stile	6500mm	052865
	CI-0525 Snap Bead	6500mm	052565



IBEAM ELEVATIONS

HALF HEIGHT WINDOW

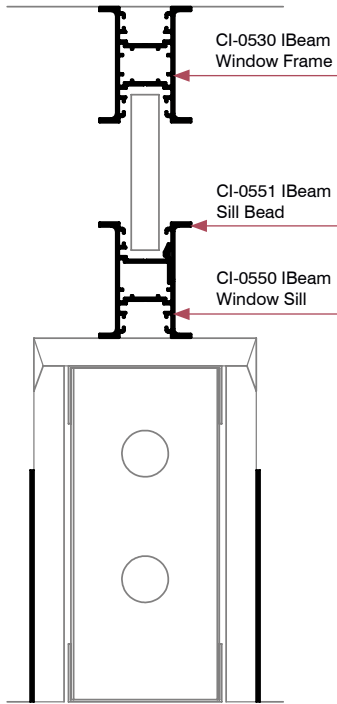

I.01

FULL HEIGHT WINDOW

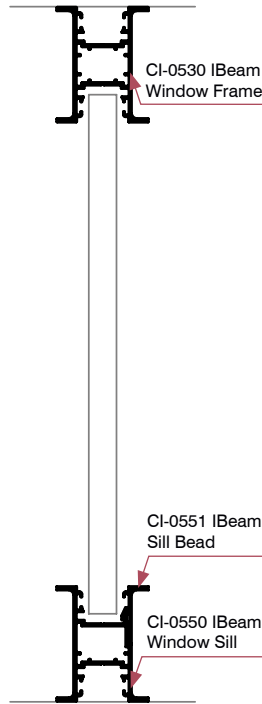

I.02

FULL HEIGHT WINDOW - WITH CARPET

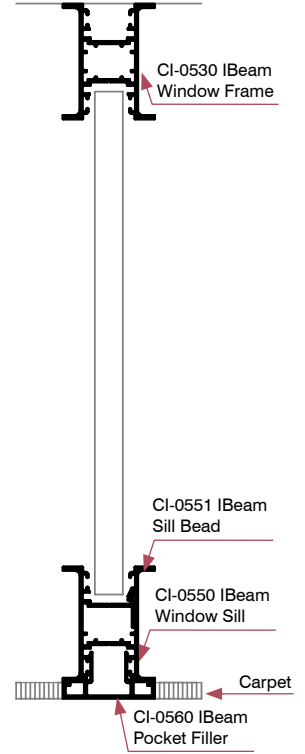

I.03

HINGE DOOR

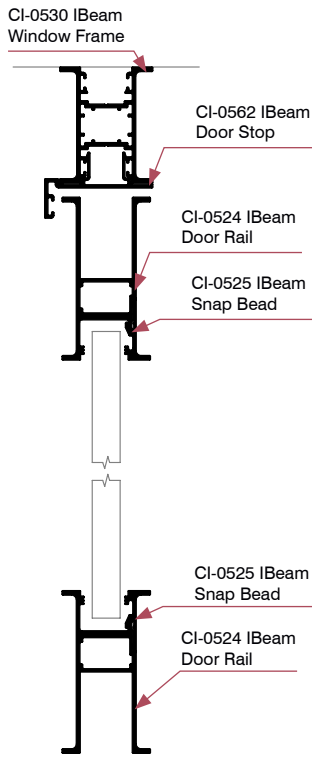

I.04

SLIDING DOOR

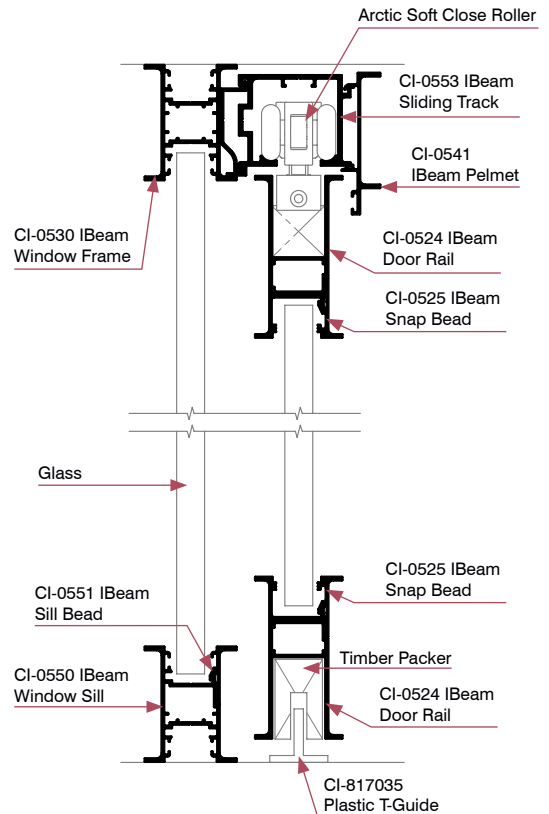

I.05

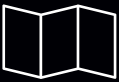

IBEAM PLAN VIEWS

WINDOW

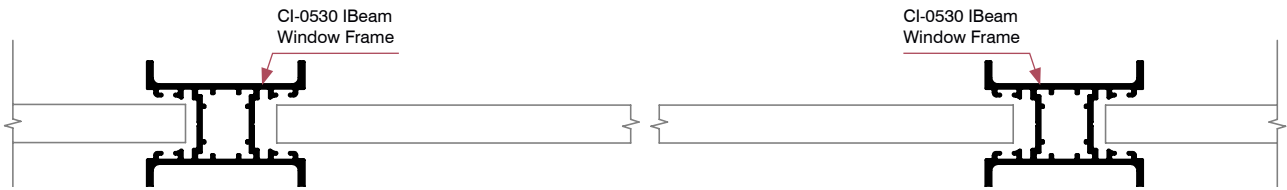

I.06

HINGE DOOR

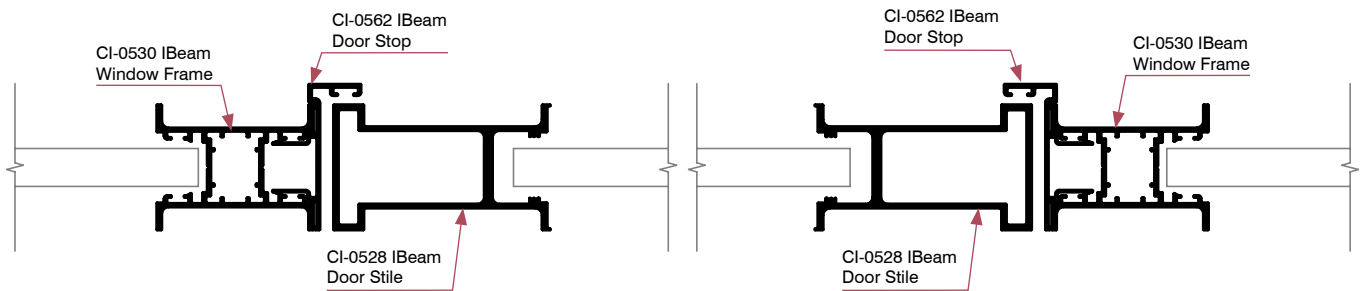

I.07



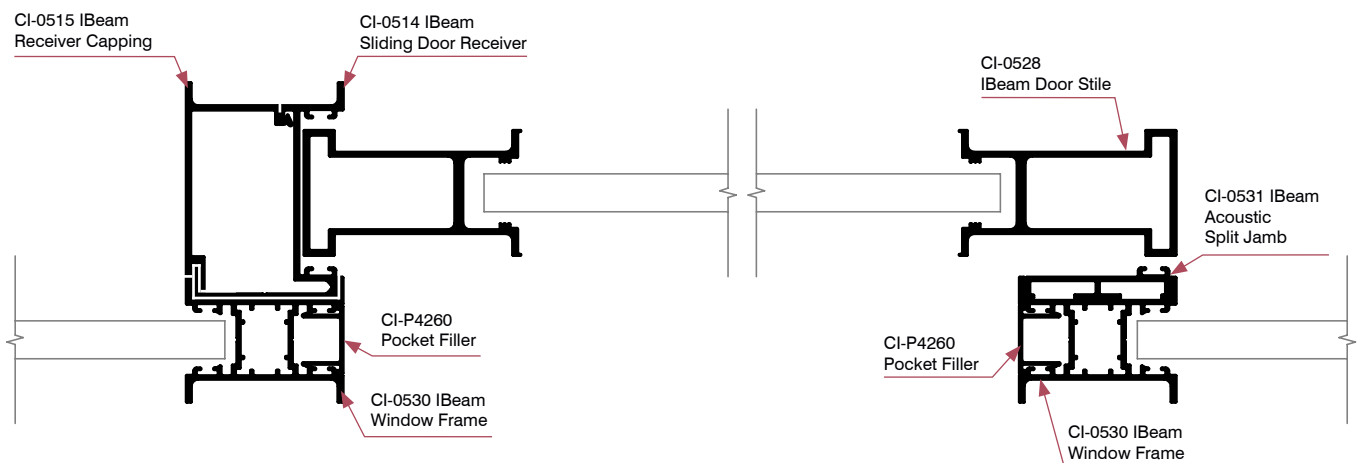





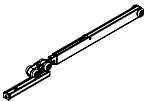

SLIDING DOOR



I.08









IBEAM HARDWARE

IMAGE	DESCRIPTION	FINISH	UNIT	CODE	COMPATIBLE WITH		
					IBEAM	IBEAM SLIDING SYSTEM	IBEAM DOORS
Door Rollers							
	Arctic Low Clearance Roller Pack	—	Each	817022		▲	
	Arctic 80kg Soft Close Low Clearance Roller Pack	—	Each	817026		▲	
	Arctic 40kg Soft Close Low Clearance Roller Pack	—	Each	817027		▲	
	Plastic T Guide	White	Each	817035		▲	
	Arctic Track Opening Cap	White	Each	817415		▲	
Caps							
	IBeam Plastic Frame Cap	Black	Each	817504NL	▲		
	IBeam Plastic Sliding Door Cap	Black	Each	817505		▲	
	IBeam Sliding Track Left End Cap	Black	Each	817508		▲	
	IBeam Sliding Track Right End Cap	Black	Each	817509		▲	
Bracket							
	IBeam Inner Bracket	—	Each	817502	▲		
Handle							
	IBeam Sliding Door Handle - 600C	SSS	Pair	817514			▲
		Black	Pair	817514.2			▲
Spigot							
	IBeam Spigot Pack	—	Each	817518			▲
Roller Bolt							
	Slimline Roller Bolt	—	Each	801009			▲



ASSOCIATED HARDWARE

COMPATIBLE WITH









IMAGE	DESCRIPTION	FINISH	UNIT	CODE	IBEAM	IBEAM SLIDING SYSTEM	IBEAM DOORS
Door Seals							
	Whisperwing Rubber Door Seal	Black	Lineal Metre	841469.B	▲	▲	▲
		Black	100m Roll	841469.BBR	▲	▲	▲
		Grey	Lineal Metre	841469.G	▲	▲	▲
		Grey	100m Roll	841469.GBR	▲	▲	▲
	6.9mm Door Seal	Black	Lineal Metre	843694.B	▲	▲	▲
		Black	100m Roll	843694.BBR	▲	▲	▲
		Grey	Lineal Metre	843694.G	▲	▲	▲
		Grey	100m Roll	843694.GBR	▲	▲	▲
	6.9mm Door Seal Self Adhesive	Black	Lineal Metre	843694.BSA	▲	▲	▲
		Black	100m Roll	843694.BSABR	▲	▲	▲
		Grey	Lineal Metre	843694.GSA	▲	▲	▲
		Grey	100m Roll	843694.GSABR	▲	▲	▲
	6.9mm Door Seal with 9mm Pile	Black	Lineal Metre	843699.B	▲	▲	▲
		Black	300m Roll	843699.BBR	▲	▲	▲
		Grey	Lineal Metre	843699.G	▲	▲	▲
		Grey	300m Roll	843699.GBR	▲	▲	▲
	6.9mm Door Stop Rubber (Bulb Seal)	Black	Lineal Metre	841369.B			▲
		Black	100m Roll	841369.BBR			▲
	Base Door Seal - Base 820	SSS	Each	812684			▲
	Base Door Seal - Base 920	SSS	Each	812685			▲
	Base Door Seal - Base 1070	SSS	Each	812686			▲
	Base Door Seal - Base 1220	SSS	Each	812687			▲
	Base Door Seal - Base 610	SSS	Each	812688			▲

NARROW BACKSET

Narrow Backset Mortice Locks

	23mm Backset Primary Latch	SSS	Each	800400			▲
		Black	Each	800400.B			▲
	30mm Backset Primary Mortice Locks	SSS	Each	800110			▲
	Flip-Lock Pack (Incl. Cyl. & T-snib) 22mm Lock Tongue - Single Door	SSS	Each	801622			▲
	Flip-Lock Pack (Incl. Cyl. & T-snib) 37mm Lock Tongue - Double Door	SSS	Each	801637			▲
	Flip-Lock Sliding Door Fab Pack (Includes Cyl. & T-snib)	SSS	Each	801629			▲
	Flip Lock Hook Throw Receiver Box	SSS	Each	801004			▲









COMPATIBLE WITH

IMAGE	DESCRIPTION	FINISH	UNIT	CODE	IBEAM	IBEAM SLIDING SYSTEM	IBEAM DOORS
NARROW BACKSET CONTINUED							
Narrow 23mm Backset Lock Kits							
	23mm Backset Lock Kit with Levers (Cylinder & Turnsnib)	SSS	Each	800420			▲
	23mm Backset Lock Kit with Levers (Cylinder & Plain)	SSS	Each	800421			▲
	23mm Backset Lock Kit with Levers (Plain & Plain)	SSS	Each	800423			▲
Levers to suit 23mm Backset Mortice Locks							
	External Plate with Lever and Cylinder Hole	SSS	Each	803150			▲
	Internal Plate with Lever and Turnsnib Assembly	SSS	Each	803350			▲
	External Plain Plate with Lever	SSS	Each	803550			▲
	Internal Plain Plate with Lever	SSS	Each	803650			▲
LOCKWOOD							
Narrow 23mm Backset Mortice Locks							
	Narrow Backset Mortice Primary Latch	SSS	—	801582			▲
Levers to suit 23mm Backset Mortice Locks							
	External Plate with Lever & Cylinder Hole	SSS	—	801481			▲
	External Plain Plate with Lever	SSS	—	801485			▲
	Internal Plain Plate with Lever & Turnsnib Assembly	SSS	—	801494			▲
	Internal Plain Plate with Lever	SSS	—	801495			▲
DOOR CLOSERS							
Large Door Closers- Series 6							
	Large Door Closer Adjustable By Position with Parallel Arm Bracket Size 2-5	SSS	Each	812601			▲
		Black	Each	812601.B			▲
	Large Door Close Adjustable By Position with Parallel Arm Bracket (Slide Arm and Hold Open Function)	SSS	Each	812606			▲



ASSOCIATED HARDWARE

COMPATIBLE WITH

IMAGE	DESCRIPTION	FINISH	UNIT	CODE	IBEAM	IBEAM SLIDING SYSTEM	IBEAM DOORS
DOOR CLOSERS CONTINUED							
Door Closer Accessories							
	Hold Open Arm Only (Suits Medium - Extra Large Door Closer)	SSS	Each	812605			▲
	Mount Plate Only (Suits Medium - Extra Large Door Closer)	SSS	Each	812609			▲
	Slide Rail w/Hold Open Function (Suits Medium - Extra Large Closers)	SSS	Each	812604			▲
		Black	Each	812604.B			▲
HINGES							
	Three Leaf Hinge	SSS	Each	811033.1	▲		▲
		Black	Each	811033.2	▲		▲
SCREWS							
Hinge Screws							
	Critech Hinge Screw - 10g x 32mm	—	Bag of 100	855032BR1	▲		▲
		—	Box of 500	855032BR5	▲		▲
		—	Box of 500	855045BR	▲		▲
		—	Bag of 100	855016BR1	▲		▲
		—	Box of 1000	855016BR	▲		▲
DOOR STOPS							
	Pencil Door Stop - Wall Mounted	Each	SSS	813350			▲
		Box of 10	SSS	813350BR			▲
	Triangular Base Door Stop - Floor Mounted	Each	SSS	813250			▲
		Box of 8	SSS	813250BR			▲
	Cylinder Door Stop - Floor Mounted	Each	SSS	813280			▲
		Box of 15	SSS	813280BR			▲
	Half Moon Door Stop - Floor Mounted	Each	SSS	813290			▲
		Each	Black	813290.B			▲
		Box of 20	SSS	813290BR			▲

GLAZING RUBBERS

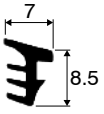

841011.B

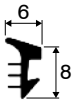

841013.B

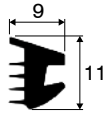

841020.B

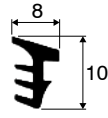

841025.B

GLAZING		DESCRIPTION	IBEAM	IBEAM DOORS
SINGLE	6.38mm glass	Glazing Rubber	841020.B	841020.B
	8.38mm glass	Glazing Rubber	841025.B	841025.B
	10.38mm glass	Glazing Rubber	841011.B	841011.B
	12.38mm glass	Glazing Rubber	841013.B	841013.B



A slimline industrial style.

Looking to discover more?

Contact us to book your
free demonstration.

www.criterionindustries.com.au



VIC

23 Scanlon Drive
Epping, VIC, 3076
T: 03 9355 0700

sales@criterionindustries.com.au

NSW

95 Victoria Street
Smithfield, NSW, 2164
T: 02 9355 0700

sales.nsw@criterionindustries.com.au

WA

58 Tacoma Circuit
Canning Vale WA 6155
T: 08 9355 0700

sales.wa@criterionindustries.com.au

QLD

22 Holt Street
Eagle Farm QLD 4009
T: 07 3193 8990

sales.qld@criterionindustries.com.au

FRONT COVER: IBEAM - ILUKA RESOURCES, WA
©DION ROBESON
BACK COVER: IBEAM - CAFE

Issued May 2020