



IBEAM HINGE & SLIDING DOOR QUICK ORDER FORM

COMPANY NAME _____	SUBURB/POSTCODE _____	SITE CONTACT PHONE _____
YOUR NAME _____	ORDER DATE _____	DELIVERY TIME _____
PROJECT NAME _____	DUE DATE _____	SPECIAL INSTRUCTIONS _____
DELIVERY ADDRESS _____	CUSTOMER ORDER # _____	_____
_____	SITE CONTACT NAME _____	_____

DOOR TYPE	DOOR FINISH	COLOUR	GLAZING

DOOR REF #	SIZE				SLIDING DOOR MACHINING <small>(refer to p. 3)</small>	LOCKS & HANDLES							SEALS			ADDITIONAL MACHINING	
	FINISHED HEIGHT <small>(mm)</small>	FINISHED WIDTH <small>(mm)</small>	INACTIVE DOOR WIDTH <small>(mm) HINGE DOOR ONLY</small>	HANDING ACTIVE/INACTIVE <small>(refer to p. 2)</small>		HANDLE TYPE <small>(refer to p. 3)</small>	LOCK TYPE <small>(refer to p. 3)</small>	SUPPLY & FIT	HANDLE HEIGHT <small>(mm to centre of handle)</small>	MACHINE ONLY				BOTTOM SEAL <small>HINGE DOOR ONLY (refer to p. 3)</small>	MACHINE ONLY		SUPPLY & FIT
										FACEPLATE	HANDLE HOLES	CYL. HOLE <small>(Outside)</small>	TURN SNIB				

SPECIAL INSTRUCTIONS

All hardware must be ordered separately. If provided from a different supplier, please include manufacturer code and specifications for accurate machining.

Send completed form to:

- VIC** orders@criterionindustries.com.au
- NSW** sales.nsw@criterionindustries.com.au
- WA** sales.wa@criterionindustries.com.au
- QLD** sales.qld@criterionindustries.com.au

VIC NSW WA QLD

For information relating to delivery and returns [click here](#)

HINGE STANDARD MEASURING AND MANUFACTURING DETAILS

HINGE DOOR WIDTH	Daylight Width - 9mm
HINGE DOUBLE DOOR WIDTH	Daylight Width - 13mm (4mm each side for hinges and 5mm gap between stiles)
HINGE DOOR HEIGHT	Daylight Height - 13mm off Finished Floor Level (3mm from the top and 12mm from base) - X (allowances for Floor Finishes)
STANDARD HANDLE HEIGHT	1000mm to centre of handle (unless otherwise specified under special Instructions)
STANDARD MACHINING DETAILS	Cylinder Hole is always machined to outside of door unless otherwise specified

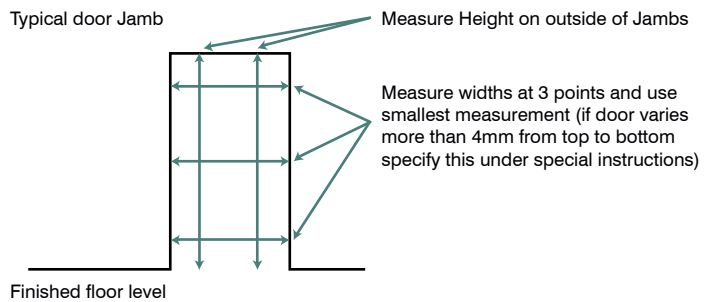
METHOD OF MEASURING HINGE DOOR

METHOD OF MEASURING SLIDING DOOR

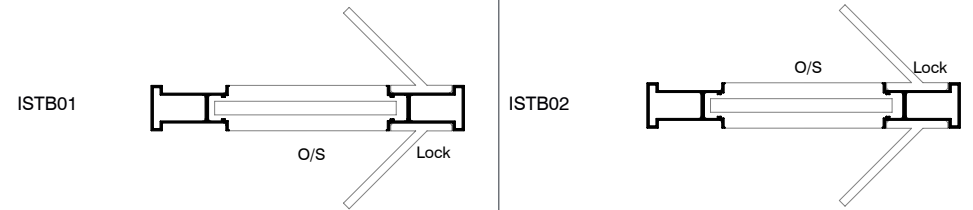
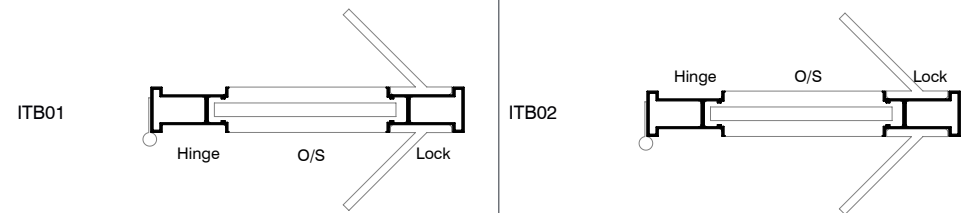
Refer to Sliding System Product Brochure on Website

IBEAM DOOR MANUFACTURING OPTIONS
SLIDING HANDING LEGEND

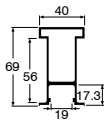
HINGE HANDING LEGEND

STILE TYPES
RAIL TYPES

CI-0528 IBeam Door Stile

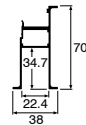







CI-0524 IBeam Door Rail

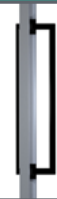

CI-0525 IBeam Snap Bead



HINGE DOORS	NARROW BACKSET MORTICE LOCK	IBEAM HANDLE	SLIMLINE ROLLER BOLT	STANDARD BOTTOM SEAL
				
Kit code	.N/BMor	.600IH	.RoSlim	.StdSea
Kit code description	Prep for Narrow Backset Mortice	Machine for IBeam handle	Prep for Slimline Roller Bolt	Prep for IS8010/RP8 Seal
Kit components	Machine for Lockwood Faceplate (66mm)	Machine centre of stile faces for IBeam handle	Machine for Slimline Roller Bolt	Machine for IS8010/RP8 seal to Base
	Machine Narrow B/Set Mortice Lock Cylinder Hole			
	Machine Narrow B/Set Mortice Lock Turnsrib Hole			
	Machine for Lever Holes			

SLIDINGDOORS	NARROW B/SET SLIDING DOOR FLIP LOCK (TONGUE ONLY)	IBEAM HANDLE	ARCTIC – LOW CLEARANCE ROLLER
			
Kit code	.N/BSli	.600IH	.ArcLow
Kit code description	Prep for Standard Hinged Mortice	Machine for IBeam handle	Prep for Arctic Sliding System - Low Clearance / Low Clearance w/ Soft Close
Kit components	Prep for Narrow Backset Sliding Mortice Lock	Machine centre of stile faces for IBeam handle	Machine and Infil Top of Door for CI-817026 Low Clearance Roller
	Machine N/Backset Fliplock Faceplate		Machine and Prep for 817100 Floor Mounted Roller Guide
	Machine Narrow B/Set Mortice Lock Cylinder Hole		Machine and Prep for 817033 Arctic Wall Mounted Roller Guide with P-Elyne Insert
	Machine Narrow B/Set Mortice Lock Turnsrib Hole		
	Machine for Disabled Turnsrib (optional)		Machine and Fill Base of Door with Timber to Suit 25 x 5mm T-Guide