

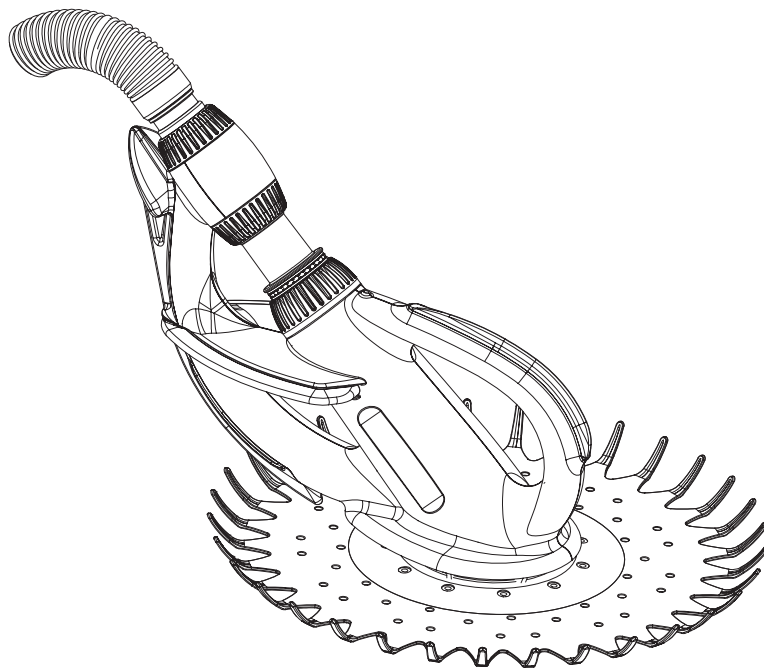

KREEPY KRAULY® KRUISER™

INGROUND SUCTION POOL CLEANER



INSTALLATION AND USER'S GUIDE

IMPORTANT SAFETY INSTRUCTIONS
READ AND FOLLOW ALL INSTRUCTIONS
SAVE THESE INSTRUCTIONS

CUSTOMER SERVICE / TECHNICAL SUPPORT

If you have questions about ordering Pentair Aquatic Systems replacement parts, and pool products, please contact:

Customer Service and Technical Support, USA

(8 A.M. to 5 P.M. — Eastern/Pacific Times)

Phone: (800) 831-7133

Fax: (800) 284-4151

Web site

Visit www.pentairpool.com or www.staritepool.com

Sanford, North Carolina (8 A.M. to 5 P.M. ET)

Phone: (919) 566-8000

Fax: (919) 566-8920

Moorpark, California (8 A.M. to 5 P.M. PT)

Phone: (805) 553-5000 (Ext. 5591)

Fax: (805) 553-5515

TABLE OF CONTENTS

Important Warning and Safety Instructions	ii	Maintenance	9
Pool Preparation	1	Cleaning the Flapper	9
Overview	1	Removing Damaged or Worn Flapper	9
Before Installation	1	Check the Vacuum Seal	9
Assembly	2	Other Maintenance	9
Parts Overview	2	Winterizing	10
Vacuum Seal Installation	3	In-Line Leaf Canisters	10
Hose Assembly	3	Troubleshooting	11
Attaching Hose Weights	3	Replacement Parts	12
Installation	4	Parts List	12
Connection to Pool with One Skimmer	4		
Connection to Pool with Two Skimmers	5		
Optional Vacuum Line Installation	5		
Adjustments	7		
Adjusting the Flow	7		
Return Line Adjustments	8		

IMPORTANT WARNING AND SAFETY INSTRUCTIONS



Important Notice:

Attention Installer: This guide contains important information about the installation, operation and safe use of this product. This information should be given to the owner and/or operator of this equipment after installation of the pool cleaner.

Attention User: This manual contains important information that will help you in operating and maintaining this pool cleaner. Please retain it for future reference. Consult Pentair with any questions regarding this equipment.

WARNING Before installing this product, read and follow all warning notices and instructions which are included. Failure to follow safety warnings and instructions can result in severe injury, death, or property damage. Call (800) 831-7133 for additional free copies of these instructions.

Consumer Information and Safety

This pool cleaner is designed and manufactured to provide many years of safe and reliable service when installed, operated and maintained according to the information in this manual. Throughout the manual, safety warnings and cautions are identified by the “**⚠**” symbol. Be sure to read and comply with all of the warnings and cautions.

WARNING HAZARDOUS SUCTION.

Do not play with cleaner or hose or apply to body. Can trap and tear hair or body parts. Hose can trip or entangle swimmers which could result in drowning.



WARNING SUCTION ENTRAPMENT, INJURY, AND DROWNING HAZARD.

If your pool has a dedicated suction port (“vac port”) for vacuuming or for an automatic pool cleaner, it must be covered when not in use. A spring loaded safety cover (a “vac port fitting”) is included with your cleaner. Install it on the suction port to prevent entrapment and injury. If the



cover provided does not fit, purchase one that does from your local pool store and install it instead. The cover should conform to IAPMO SPS4-99A.

WARNING **Stop pump** before attempting to clean unit. Do not allow swimmers in pool while pool cleaner is operating.

WARNING To reduce the risk of injury, do not let children use or play with pool cleaner.

WARNING Do not allow swimmers in the pool while pool cleaner is operating. Hose can trip or entangle swimmers which could result in drowning.

CAUTION Moving parts may injure hands or fingers. Stop pump before attempting to clean out pool cleaner head.



General Installation Information

Pre-Installation Check List

Before installing your cleaner, review and understand all warnings and safety information in this guide. Failure to follow these instructions or improper installation of the cleaner can result in damage to the pool finish or the vinyl liner, Pentair Water Pool and Spa, Inc. disclaims any liability for repairs or replacement to any of these structures or components of the customer’s pool.

Before installing the cleaner in a vinyl liner pool:

Check liner closely for signs of deterioration or damage from age, chemicals, pool wall damage, etc. If any damage is found, have a qualified pool professional make all the necessary repairs. Also, if there are stones, roots, etc., under the liner, remove them before installing the cleaner.

Before installing the cleaner in a gunite pool or a pool that is partially or completely tiled:

Repair loose tiles and tighten any loose light rings.

Before installing the cleaner, clean your filter system:

Make sure you have cleaned the filter, including backwashing, rinsing, and emptying all baskets. A clean system is necessary for proper cleaner operation and coverage.

Before installing the cleaner, understand cleaner coverage:

The cleaner is designed to rid your pool of debris in approximately 4-6 hours. Less time could be needed, depending on the pool size. The cleaner was not designed to automatically clean steps or swimouts or to work under a solar cover. It was also not designed to do initial cleanup for a new pool or when opening your pool for the season.

AFTER installing the cleaner, make sure the cleaner is operating correctly:

The cleaner may need some minor adjustments to make sure it is operating properly so there is no damage to the pool finish. Certain vinyl liner patterns are particularly susceptible to surface wear, pattern removal, ink rubbing off of, or serious scratches to the pattern caused by objects coming into contact with the vinyl surface, including automatic pool cleaners. Pentair Water Pool and Spa, Inc. is not responsible for any pattern removal, abrasions or markings on vinyl liners.

Warnings and safety instructions for Pentair Water Pool and Spa, Inc. pumps and other related products are available at:

<http://www.pentairpool.com/pool-owner/safety-warnings/> or call (800) 831-7133 for additional free copies of these instructions.

Please refer to <http://www.pentairpool.com/pool-owner/safetywarnings/> for warning and safety instructions related to this product.

IMPORTANT WARNING AND SAFETY INSTRUCTIONS

Disclaimer of Liability About your Pool and Cleaner

There are a multitude of factors that contribute to the life of your pool. The pool cleaner is a very passive product that will have no impact on pool life.

Please be aware that over time, deterioration, discoloration and brittleness of any pool finish can be caused separately by, or in combination with, age, an imbalance in pool water chemistry, improper installation and other factors. Suction side pool cleaners, such as the pool cleaner, will not remove or cause wear on "good" pool plaster. In fact, the opposite is true—pool plaster will eventually cause wear on the cleaner.

The same situation holds true for vinyl-lined in-ground swimming pools, because vinyl liners are also affected by the environment and factors such as pool water chemistry, sunlight and the pool's surroundings. Therefore over time, vinyl can become brittle and weak. In addition, vinyl-lined pools are affected by the workmanship, composition and installation of the liner and the workmanship and quality of construction of the supporting walls and pool base. These are all factors which can contribute to liner failure. The existence of any of these type of conditions in your pool is not caused by the use or operation of the pool cleaner. The manufacturer disclaims any liability for repairs or replacement to any of these structures or components of the customer's pool.

The pool owner must assume all responsibility for the condition and maintenance of the pool's surface, water and deck.

Before the cleaner is installed, please take a moment to record the serial number. This number is located under the rear handle of your cleaner. You will be asked for this number when you contact our Technical Support Department.

SERIAL # _____

SAVE THESE INSTRUCTIONS

POOL PREPARATION

Overview

The Kruiser™ Inground Suction Pool Cleaner connects easily to your skimmer or vacuum line fitting without tools. The cleaner uses the suction power from your filter pump to move across the bottom of your pool, capturing large and small debris.

- Built-in bumper assures free movement around steps and ladders for total cleaning coverage and uninterrupted, hands-free operation.
- No bags or compartments to empty or replace, the dirt and debris go right into the filtration system.

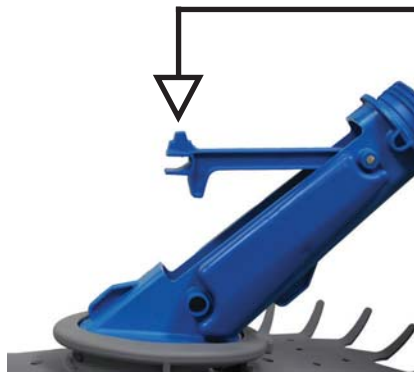

Flapper—the only moving part in the cleaner for a simple and dependable propulsion system.

Before Installation

Before assembling and installing the pool cleaner, be sure your pool is clean and algae-free in order for the cleaner to have maximum traction. If necessary, make the following preparations before proceeding.

Note: Before setting up this product, read and follow all warning notices and instructions, starting on page ii.

1. Hand vacuum your pool to remove debris.
2. Chemically balance and stabilize the pool water.
3. Clean the filter system.
4. Empty the Skimmer Basket.
5. Empty the Pump Strainer Basket.

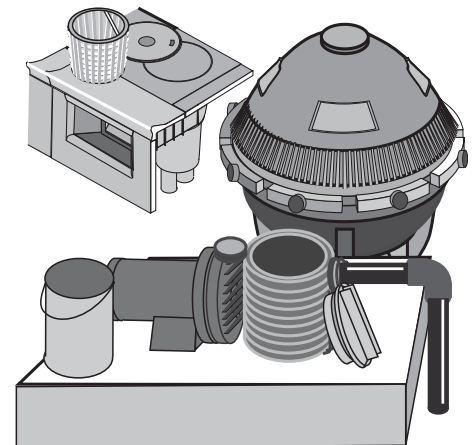

ASSEMBLY

Parts Overview

Your Kruiser™ Inground Suction Pool Cleaner includes the following components:

1. Cleaner body – (1)
2. Vacuum Seal – (1)
3. Regulator Valve – *Adjustable* (1)
4. Regulator Cap – (1)
5. Flow Gauge – (1)
6. Threaded Compression Adapter – (1)
7. Hose Sections – *1m* (12)
8. Hose Weights – (2)
9. Eyeball Diverters – (2)
10. 45 Degree Elbow – (1)
11. Hose Protector Sleeve – (1)
12. Safety Vac-Lock Fitting – (1)

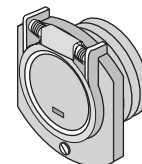
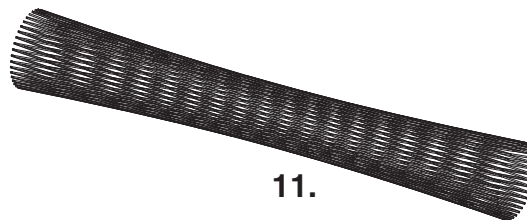
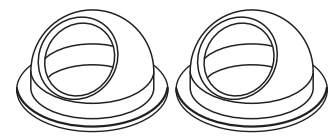
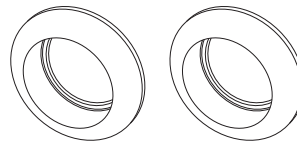
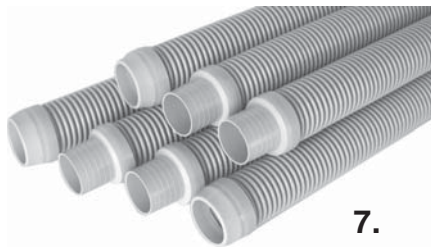
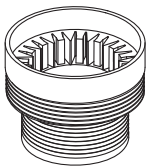
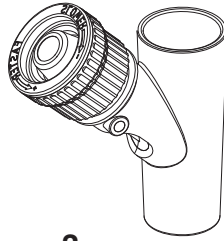
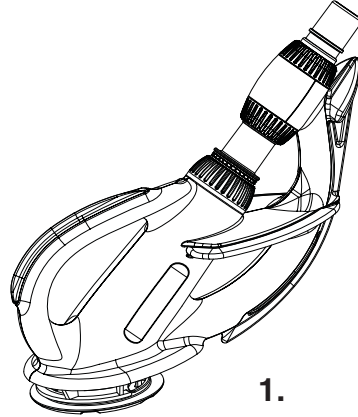

Vacuum Seal Installation

1. Pull the Vacuum Seal over the Kruiser™ Inground Suction Pool Cleaner's Foot Pad to fit properly into the Foot Pad's groove as shown in the illustration.
2. Be sure the curved tips face upwards.
3. Check with your hand that the Vacuum Seal rotates freely once it is in the groove.

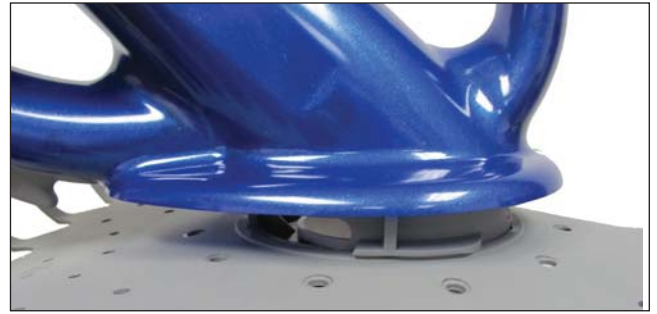

Hose Assembly

While the cleaner is operating:

1. Position cleaner at the furthest point of the pool from where it's attached. Use a pool pole and brush to easily position the cleaner in the pool.
2. The hose should be long enough to reach the end of the pool, plus one hose section.
3. Remove any excess hose lengths from the middle of the hose assembly. This will ensure you do not alter the position of the hose float.
4. Save extra hose sections for use as needed for replacement.

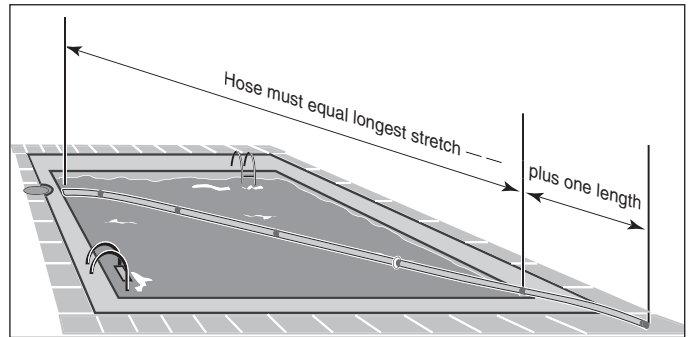

Note: Turn pool pump off when adding or removing hose sections.

Attaching Hose Weights

The number of hose weights required is determined by the maximum depth of your pool - the deeper your pool, the more weight is needed. Use the table below to find the number of hose weights needed for your pool.

1. Attach hose weights to the hose to keep the cleaner at a 45° angle in the pool for maximum coverage.
2. If needed, adjust the 1st hose weight (closest to the cleaner) towards the 2nd hose weight.

Note: The water density in each pool can vary due to mineral and salt content.

3. Adjust the hose weights until the cleaner sits evenly on the bottom of the pool at a 45° angle.

Pool Depth	Weight Placement
Less than 6 feet	No weights required
More than 6 feet, but less than 9 feet	1 weight: one 12 to 20 inches from the swivel head
More than 9 feet but less than 12 feet	2 weights: one 12 to 20 inches, one 6 feet from the swivel head.
More than 12 feet	3 weights:* one 12 to 20 inches, one 6 feet and one 10 feet from the swivel head.

*Contact your Pentair Water Pool and Spa®, Inc. dealer if you need to purchase additional hose weights.

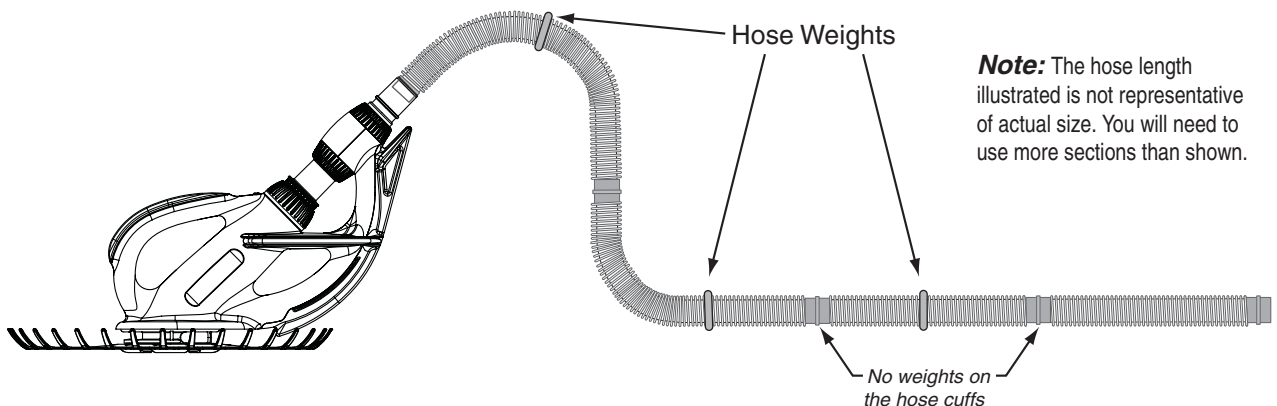

INSTALLATION

Connection to Pool With One Skimmer

Use the adjustable regulator valve to balance the water flow between the skimmer and the Kruiser™ Inground Suction Pool Cleaner - this valve changes the amount of water flow to power cleaner.

1. Turn the pool pump off.
2. Close main (bottom) drain and all suction lines, except the line from the skimmer.
3. Remove skimmer basket.
4. Screw threaded compression adapter into the vacuum connection in the bottom of the skimmer.
Note: Use two wraps of thread seal tape around threads to ensure easy removal.
(If the opening in the bottom of the skimmer is not threaded, use a 2" hose cone. It is not included but can be purchased separately).
5. Press the adjustable regulator valve into the threaded compression adapter.
6. Place the cleaner into the pool and allow it to sink to the floor.
7. Continue to feed hose vertically down into the pool until completely filled with water and purged of air.
8. Slide hose protector sleeve on the hose section connected to the regulator valve in the skimmer to prevent rubbing against skimmer wall.
9. Insert hose end through the skimmer opening and connect to the adjustable regulator valve.
10. Open main drain and suction lines and turn the pump on to start the cleaner.

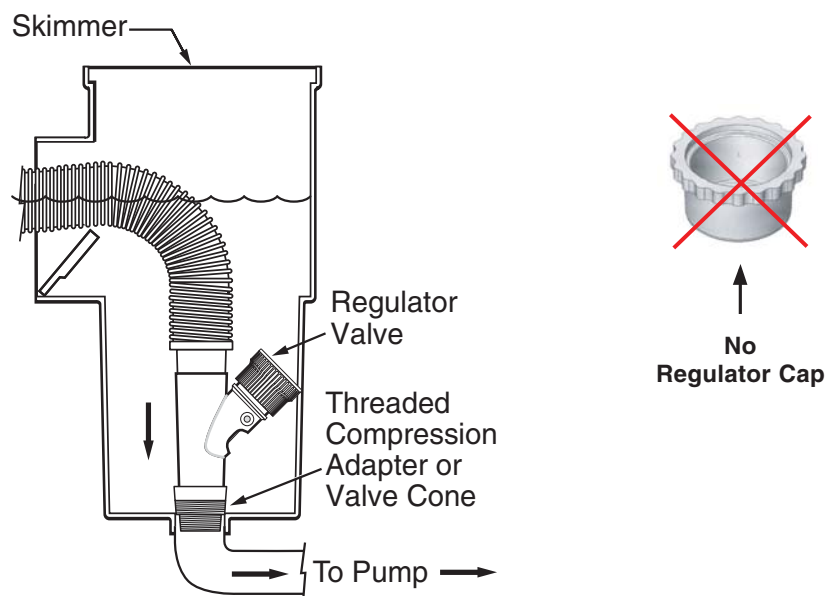

Connection to Pool With Two Skimmers

1. Select one skimmer for the Kruiser™ Inground Suction Pool Cleaner.
2. Close off the other skimmer with the pump valve.
3. Connect the end of submerged hose into the selected skimmer.
4. Refer to the “Pool with One Skimmer” instructions on the previous page, starting from step 3.

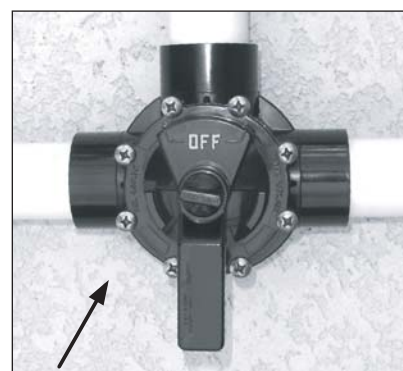

Pump Valve

Optional Vacuum Line Installation

Install the adjustable regulator valve in the skimmer if attaching cleaner to a dedicated vacuum line.

Note: Be sure that your Dedicated Suction Port is fitted with a Safety Vac-Lock Fitting. If not, install the one that is provided with your cleaner.

1. Turn the pool pump off.
2. Close the main drain and all suction lines, except the skimmer and the vacuum line that will connect to the cleaner.
3. Thread the vac-lock wall fitting into the end of the dedicated suction line.

Note: Use two wraps of thread seal tape around the threads to ensure easy removal.
4. Place the cleaner (with the hose and hose weights) into the pool and allow it to sink to the floor.
5. Continue to feed hose vertically down into the pool until completely filled with water and purged of air.
6. Insert the hose end of the last hose section into the vac-lock wall fitting.

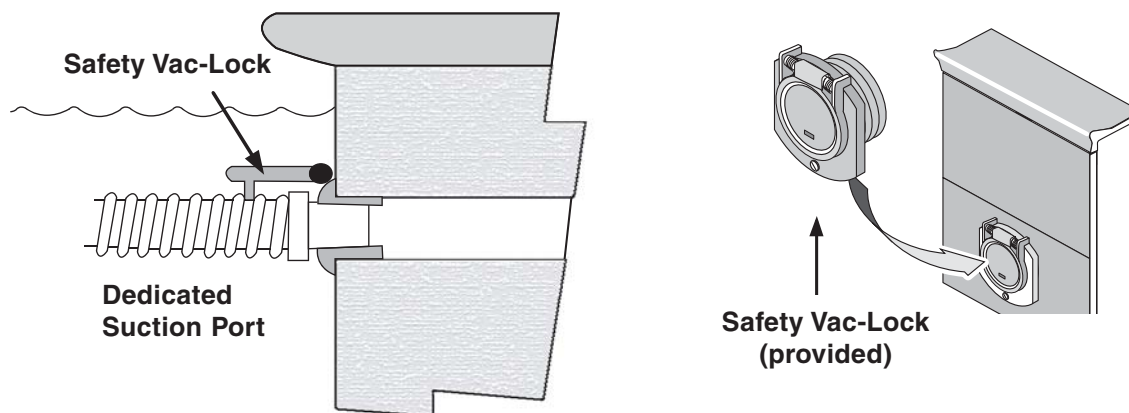

Optional Vacuum Line Installation, (Continued)

7. Screw the threaded compression adapter into the vacuum connection in the bottom of the skimmer.

Note: Use two wraps of thread seal tape around the threads to ensure easy removal.

(If the opening in the bottom of the skimmer is not threaded, use a 2" hose cone. It is not included but can be purchased separately).

8. Fasten the regulator cap onto the top of the adjustable regulator valve

This activates the adjustable regulator valve and assures that an accurate amount of water will flow through the vacuum line and the Kruiser™ Inground Suction Pool Cleaner.

Without the regulator valve cap, the adjustable regulator valve and the cleaner will not function properly.

9. Press the adjustable regulator valve into the threaded compression adapter.

10. If your pool does not have a Dedicated Suction Port, go to the instructions on page 4 or 5.

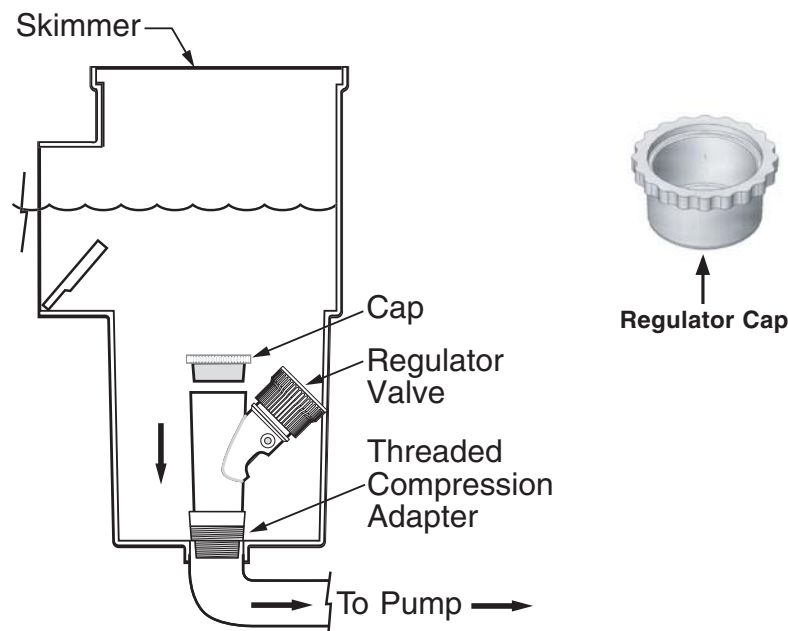

ADJUSTMENTS

Turn on the pool pump after completing the installation and allow the pump to run for a couple of minutes to be sure all air is out of the system.

Check the water flow and return line adjustments after installing your cleaner.

Adjusting The Flow

1. Turn the pool pump off.
2. Remove the cleaner and connect the Flow Gauge to the end of the hose. Be sure to keep the hose submerged to prevent any air entry.
3. Turn the pump on.
4. With the pump running, turn the Adjustment Knob of the Regulator Valve "Faster" or "Slower" until the disc indicator in the Flow Gauge settles between "Maximum" and "Minimum" flow.

Note: If you have very strong pump and the flow is still over "Maximum", you may need to open the main drain slightly.

5. Turn the pool pump off.
6. Remove the Flow Gauge and connect the Cleaner to the end of the hose.
7. Be sure you keep the hose submerged to prevent any air to enter into it.
8. Allow the cleaner to drop to the pool floor.
9. Turn the pool pump on.

Note: Optimizing the water flow **does not mean** maximizing the flow through the cleaner. It is recommended to use less suction to be sure the cleaner travels in a random pattern, able to reach all areas of your pool.



Flow Gauge

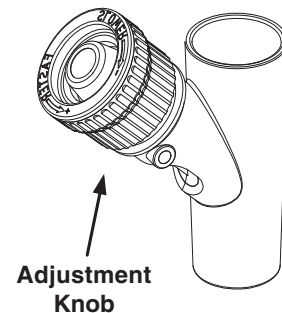

Adjustment Knob

Return Line Adjustments

Adjust the Eyeball Diverters to direct the water slightly downward to move the Kruiser™ Inground Suction Cleaner randomly throughout the pool. Water circulating at the surface will influence the hose and limit cleaner coverage.

1. Adjust the Eyeball Diverters by loosening the lock ring and redirecting the Eyeball Diverters slightly downwards.
2. Try different directions to see what works best in your pool. Allow time for the body of water to settle into the new pattern.
3. If it is difficult to adjust your existing Eyeball Diverters, replace the eyeball component with the new Eyeball Diverters (included).

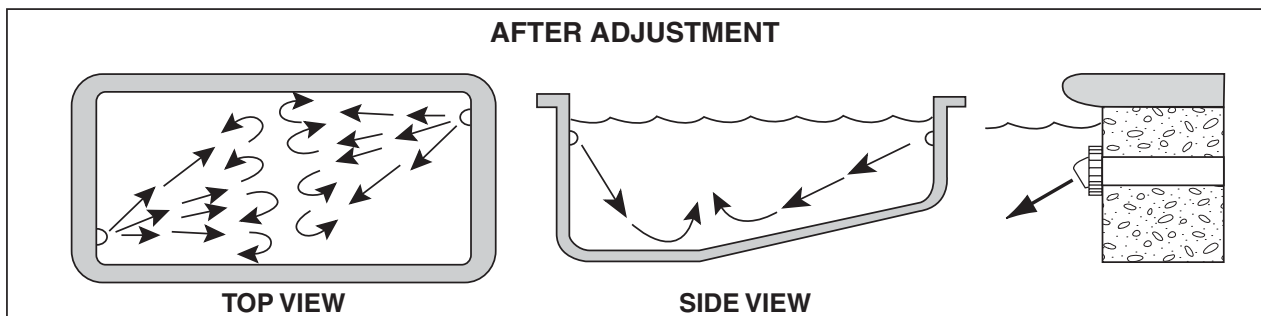
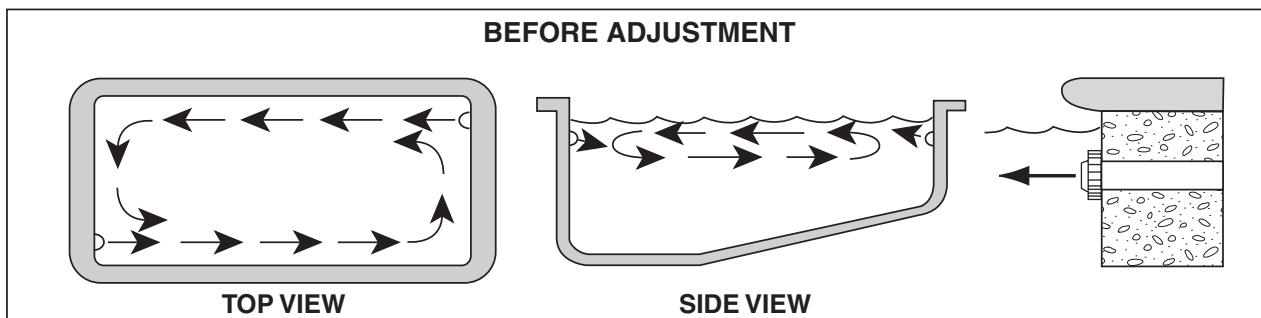
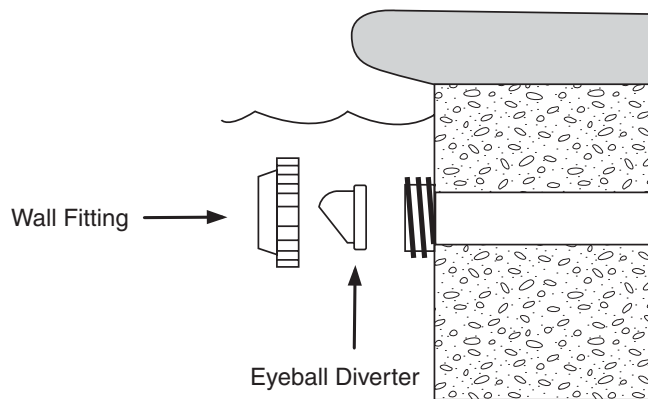

MAINTENANCE

The Kreepy Kruiser™ Inground Suction Pool Cleaner requires very little maintenance but it is important to regularly check the following items.

Cleaning the Flapper

1. Turn off the pump.
2. With your hand, unscrew and lift the external housing to view the flapper.
3. Push the latch upward to remove the flapper lid. Take off the lid and inspect the flapper for debris. (See images on this page).
4. Be sure the flapper is moving freely up and down and that it is securely clipped into place.
5. Put the lid back and slide the lock down to close. (No tools are required).
6. Place the external housing back over the flapper and hand tighten.



Removing Damaged or Worn Flapper

1. Pull the flapper and wiggle outward until it un-clips from the pin.
2. To install the new flapper, push it in firmly (TOP side up as marked) onto the pin until it snaps into place. If flapper is clipped the wrong way (TOP side down) you will not be able to close the lid.

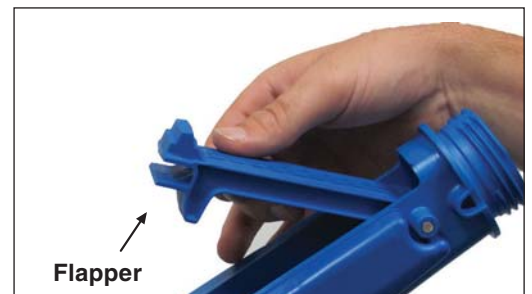

Check the Vacuum Seal

1. If the vacuum seal becomes thin and too floppy, it will impair the correct random movement of the cleaner.
2. Replace the vacuum seal if needed.

Other Maintenance

- Inspect the foot pad for wear. Replace when the traction pads on the bottom have worn down.
- Inspect the regulator valve and flush away any debris build up.
- Clean your filter system.
- Empty the skimmer basket.

Other Maintenance, (Continued)

- Empty the filter pump strainer basket.
- Use your flow gauge to ensure correct water flow for your cleaner.
- For best results and to maintain proper operation, only use the original hoses.
- When not in the pool, keep the Kruiser™ Inground Suction Pool Cleaner's vacuum seal flat to avoid warping.
- Your cleaner can stay in the pool at all times, however, when using the pool, disconnect the cleaner and hose and pull it to one side of the pool.

Note: Remove the cleaner from the pool before any chemical shock treatment.

Winterizing

- When storing or winterizing the cleaner, do not coil the hose.
- Lay the hose flat in an area protected from direct sunlight. It is also important to remove the vacuum seal from the Cleaner and store it flat.

In-Line Leaf Canisters

If your pool is exposed to large quantities of leaves, we suggest purchasing and installing an in-line leaf canister, (P/N R211084 or R211086).

A leaf canister will provide more debris-loading capacity and also provides a water by-pass when the canister is full. It is very important that the pump will not starve for water!



TROUBLESHOOTING

Use the following troubleshooting information to resolve possible problems with your Cruiser™ Inground Suction Pool Cleaner.

Problem	Corrective Action
<p>Cleaner is sluggish or has stopped operating.</p>	<p>Check Cleaner for blockage inside the Flapper chamber. Refer to Maintenance on page 9.</p> <p>Clean your filter system, empty pump basket and empty skimmer basket.</p> <p>Inspect the Regulator Valve and flush away any debris buildup.</p> <p>Check the hose for blockage.</p> <p>Check the hose for leaks by lifting each section above water and listen for the leak.</p> <p>Using your Flow Gauge, verify proper water flow to your Cleaner. Refer to page 7.</p>
<p>Cleaner gets stuck on the steps.</p>	<p>Adjust the Eyeball Diverter of the return flow towards the problem area to guide the Cleaner away from the steps. Refer to page 8.</p> <p>Verify proper hose length and correct position of the Hose Weights. Refer to page 3.</p> <p>Purchase the optional 12" or 16" Deflector Wheel.</p> <p>Using your Flow Gauge, Increase or decrease the flow to your cleaner within the maximum/minimum range.</p>
<p>Cleaner travels in repetitive pattern.</p>	<p>Adjust Eyeball Diverters as described on page 8.</p> <p>Verify proper hose length and correct position of the Hose Weights. Refer to page 3.</p> <p>Place one Hose Weight 2" to 4" from the Cleaner head.</p> <p>Check the Kreepy Cruiser's hose to ensure it has not become bent or kinked. It only takes one bent or kinked hose section to hinder the cleaning coverage. One way to check for kinks in the hose is to lay each section flat on your pool's deck, (or other flat surface). The hose should be perfectly straight and flat. Do Not coil the hose when taking your cleaner out of the pool because it will retain the coil shape, forming a bend or kink.</p>
<p>Cleaner does not transit onto the wall.</p>	<p>Using your Flow Gauge, verify proper water flow to your Cleaner. Refer to page 7.</p>
<p>Cleaner stays in one side of the pool.</p>	<p>Adjust Eyeball Diverters as described on page 8.</p> <p>Verify proper hose length and correct position of the Hose Weights. Refer to page 3.</p> <p>Remove or add one hose section.</p>

REPLACEMENT PARTS

Parts List

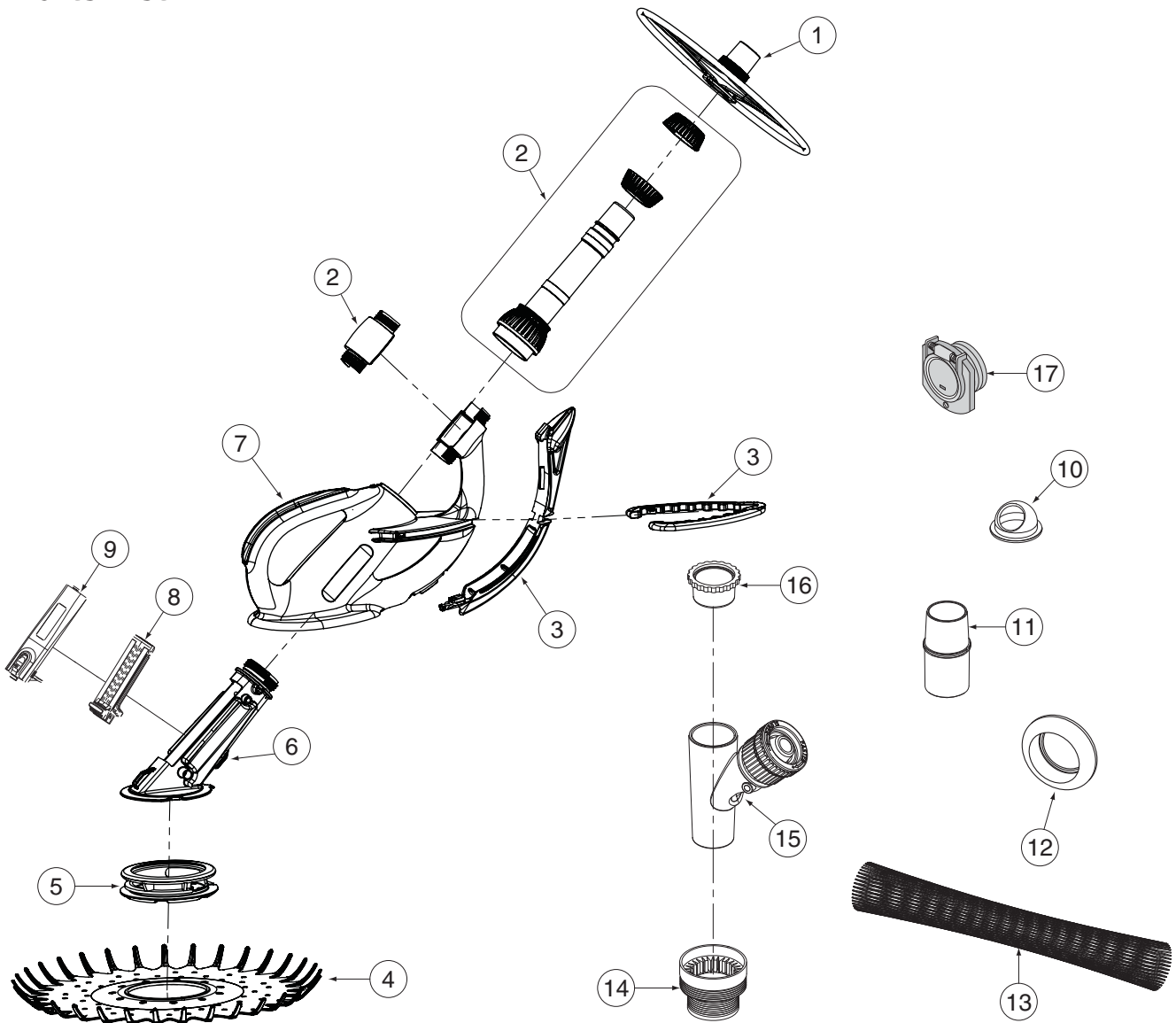

ITEM NO.	P/N	DESCRIPTION
----------	-----	-------------

1	K12458	Deflector Wheel
2	K12444	Swivel Kit
3	K12451	Bumper Kit (Horizontal & Vertical)
4	K12442	18" Vacuum Seal Kit
5	K12450	Foot Pad Kit
6	K12443	Internal Kit
7	K12441	External Housing Kit
8	K12415	Silent Flapper Kit
9	K12412	Lid & Lock Kit
10	41201-0236	Eyeball Diverter

ITEM NO.	P/N	DESCRIPTION
----------	-----	-------------

11	41200-0212	Flow Gauge
12	K12454	Hose Weight
13	K60465	Hose Protector
14	K12079	Threaded Compression Adapter
15	41200-0200	Regulator Valve (Adjustable)
16	41200-0211	Regulator Cap
17	K12500	Safety Vac-Fitting
*	K01213	Hose Kit (12 M/F Sections)

(*) - NOT SHOWN

NOTES



1620 HAWKINS AVE., SANFORD, NC 27330 • (919) 566-8000
10951 WEST LOS ANGELES AVE., MOORPARK, CA 93021 • (805) 553-5000
WWW.PENTAIRPOOL.COM

All Pentair trademarks and logos are owned by Pentair or one of its global affiliates. Pentair Aquatic Systems®, Kreepy Krauly® and Kruiser™ are trademarks and/or registered trademarks of Pentair Water Pool and Spa, Inc. and/or its affiliated companies in the United States and/or other countries. Unless expressly noted, names and brands of third parties that may be used in this document are not used to indicate an affiliation or endorsement between the owners of these names and brands and Pentair Water Pool and Spa, Inc. Those names and brands may be the trademarks or registered trademarks of those third parties. Because we are continuously improving our products and services, Pentair reserves the right to change specifications without prior notice. Pentair is an equal opportunity employer.

© 2015 Pentair Water Pool and Spa, Inc. All rights reserved. This document is subject to change without notice.



P/N K60460 REV. C 11/30/15