



# **OMT – M3 Electric Bike Intelligent Display User Manual**

[Revision 1.0 MAR 2020]

---

READ THIS MANUAL CAREFULLY BEFORE USE – FAILURE TO DO SO MAY RESULT IN INJURY, & PROPERTY DAMAGE.

PRODUCTS COVERED BY THIS MANUAL MAY VARY IN APPEARANCE, ASSEMBLY, INCLUSIONS, SPECIFICATIONS, DESCRIPTION AND PACKAGING.

---

# 1. Material&Dimension

## 1) Material

Caser and Cover and Press button: ABS,

LCD window: PMMA

## 2)Outside and mounting dimension(mm)

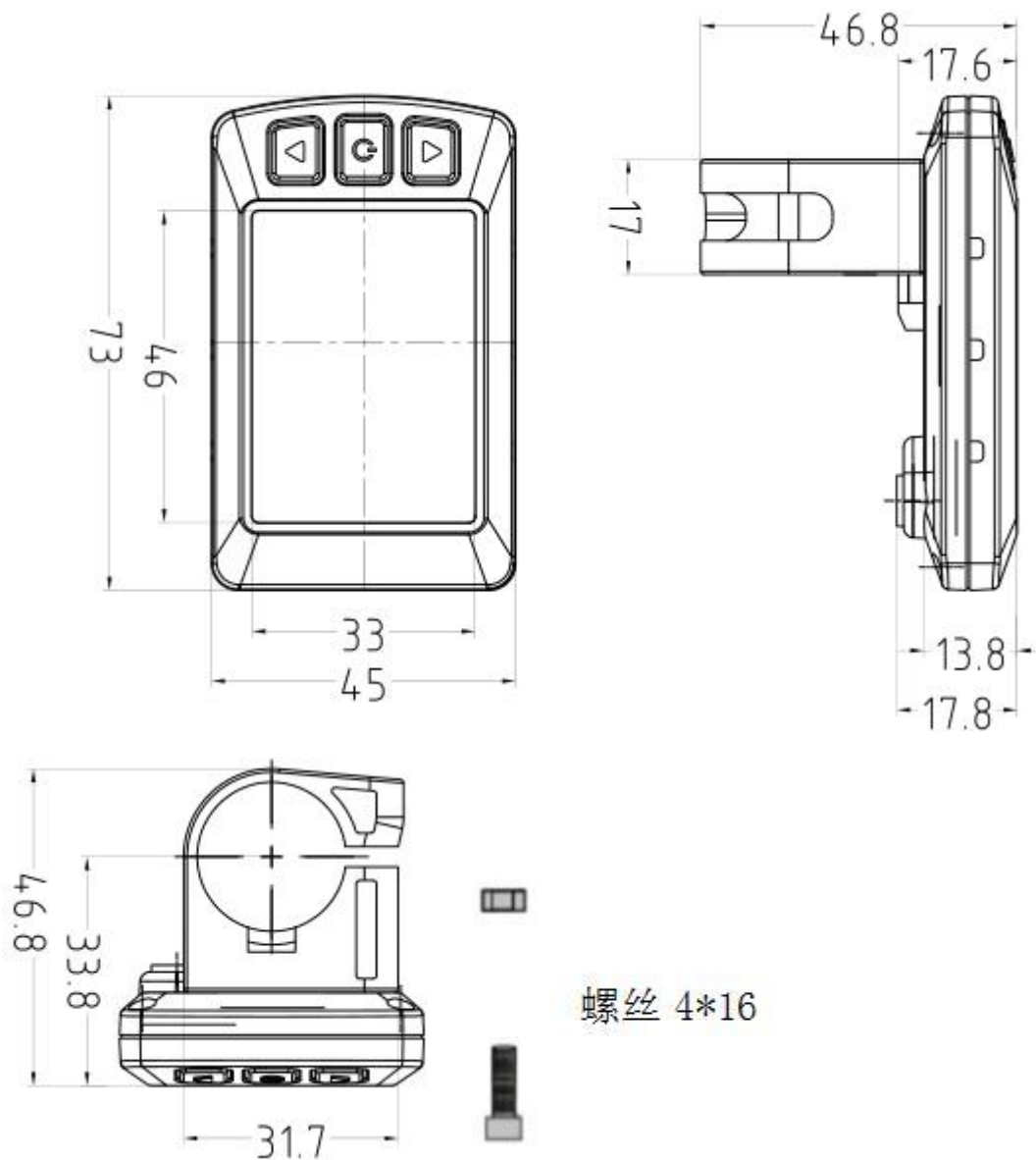

### 3) Connection diagram:

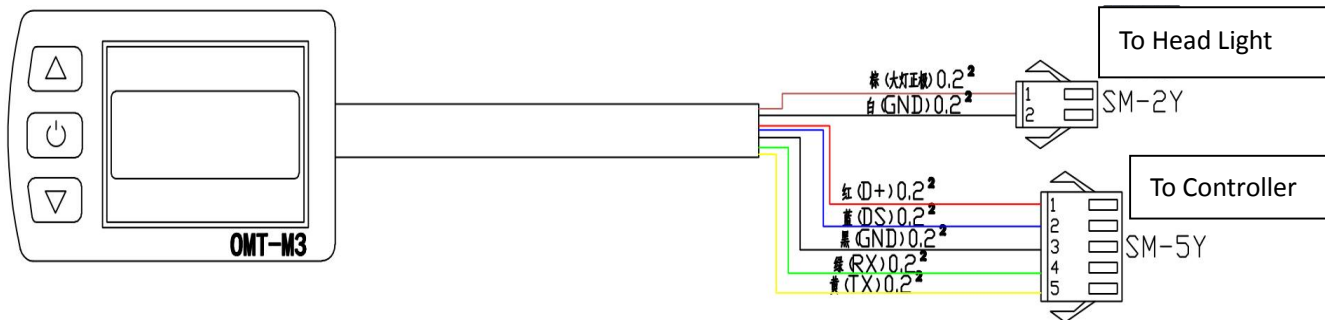

#### Wire definition:

Red: Power supply-VCC

Blue: Electronic lock-DS

Black: GND

Green: Data RXD

Yellow: Data TXD

BROWN: Head light(+) -DD

White: Head light(-)-GND

Remark: Connectors and Wire colors could be customized

#### 5) Installation

● Install the display in the middle of handlebar, then adjust to suitable angle, install the press button to left side of handlebar.

● Power off the device, connect the device to controller.

● Power on



## 2. Overview of S900

### 1) UART protocol:

Equipped with independent press buttons

### 2) Speed:

Real-time SPEED, MAX SPEED, Average SPEED

### 3) kmh/mile:

Kmh/MPH according to habit

### 4) Battery level:

Indicates the battery level in real time

### 5) Head light control:

Press  button for 3 seconds to power on/off

### 6) Back light adjustment:

3-level adjustment

7) Assist level:

From 1 to 3, press button to change assist level.

8) Distance:

ODO/Trip/Driving duration

9) Error code:

Please refer to appendix table 1 for definition

10) 6km mode:



In this mode, it will display  on the screen.

11) Parameter setting:

Set parameters, such as: wheel size, speed limit etc

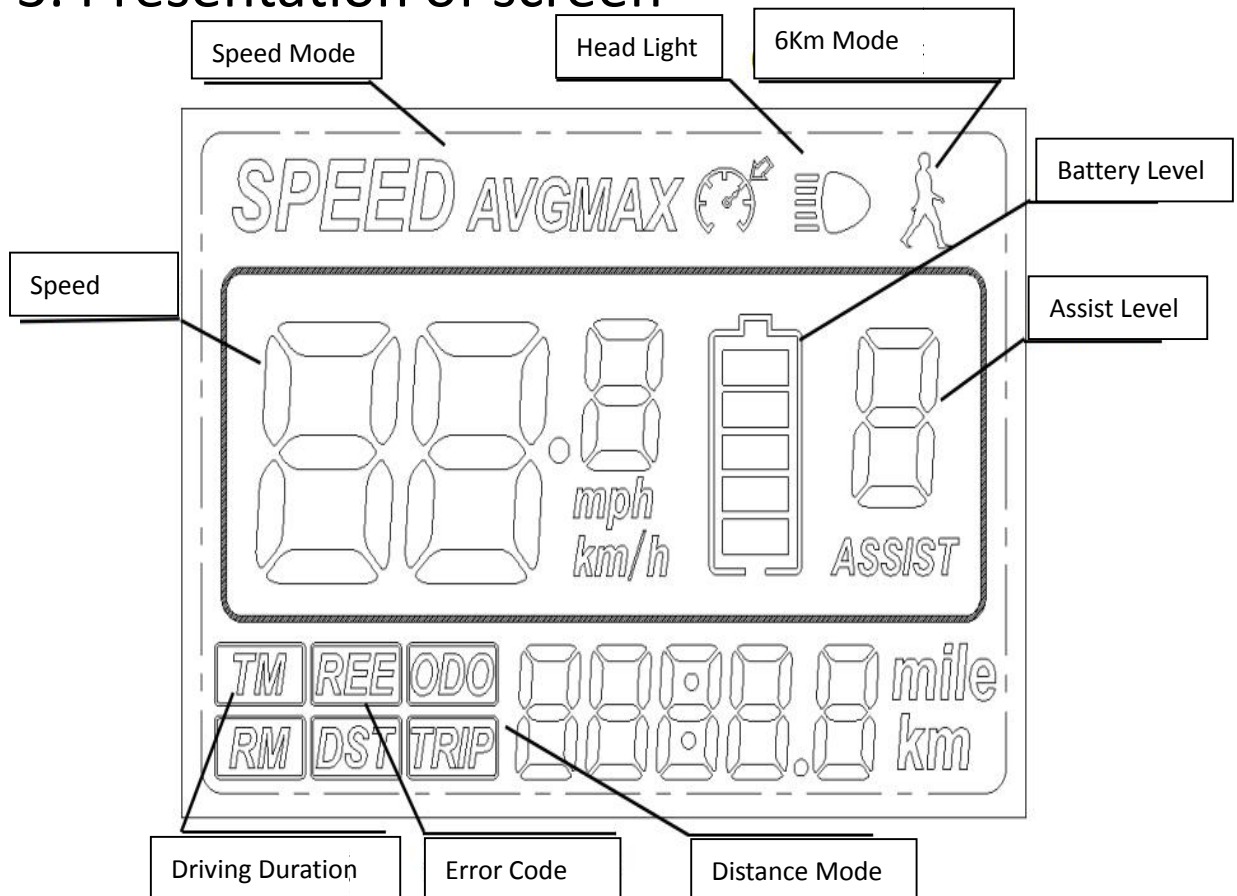
### 3. Presentation of screen



- 1) Battery level: 5 levels, voltage interval could be customized
- 2) Speed: Average SPEED/MAX SPEED/Real-time SPEED
- 3) Speed unit:  Kmh/MPH
- 4) 6km mode: 6km mode Display .
- 5) Assist level: actual assist level 1~3.
- 6) Head light icon: indicates when head light and back light are on.
- 7) Distance: Trip/ODO.
- 8) Error code: “REE” and code when there is error



## 4. Press button definition

OMT-M3 uses independent press button, in total three buttons:



## 5. Operation instructions

### 1) Power ON/OFF



When the power is off, Long press  ( Power ) during 3 seconds , screen will display all contents and start to normal working mode, and controller will be turned on When the power is on, Long press  ( Power ) during 3 seconds, screen will be powered off, and controller will be turned off . If no any operation both on bike and display during 10 minutes (time could be set), the

display will turn off automatically , in this case, no power consumption for both display and controller.



Figure 2

2) Different Speed display:

Long press  and  to switch different speed information,  
Real time speed ( SPEED ) → Max speed ( MAX SPEED ) → Average  
speed ( AVGSPEED ) → Driving Time

Real time speed



Figure 3



Figure 4



Figure 5

### 3) ODO/TRIP/ Driving Time/Error Code

Short press  to switch ODO/TRIP/ Driving Time/Error Code

Trip(Single trip distance)→ODO(Accumulated distance)→

TM(Driving Time) →REE (Error Code)。



ODO

Figure 6



TRIP

Figure 7





Driving Time

Figure 8



Error Code

Figure 9

#### 4) Assist level



Short press  or  to change assist level, default value is level 3



Figure 10



Figure 11





#### 5) Head light control

Long press  for 3 seconds turn on/off the head light.



Figure 12

### 6) 6km mode





When the bike is stopped, long press , will enter 6km/h mode, the speed will be 4.5~7.5km/h according to different road conditions, “” will show up on screen, long press  again or short press , will quit 6km/h mode. Long press or short press could be customized by clients.



### 6Km Mode



Figure 13

## 6. Parameter setting

When the display is powered on, long press  and , will enter parameter setting mode ( Figure 14), in this mode, can change parameter values, long press again  and  will quit parameter setting mode or no operation during 10s will also quit this mode.

In parameter setting mode, short press  / will change parameter value, short press  will save current value and switch to next parameter.

1) P01-back light lightness:



short press  /  will switch from 1 to 3, Level 3 is lightest. Level 2 is default value.



Figure 14



2) P02-kmh/MPH:

Short press  /  to Switch kmh/MPH.





Km by default  
Figure 15

3) P03-Working voltage:

short press  /  to switch 24V,36V,48V, Default value is 36V.



4) P04-Auto shutdown time:

short press  /  to switch from 0 to 60, it is the time(in minutes) to shut down the screen automatically if no operation 0

means never shut down, Default value is 10 minutes

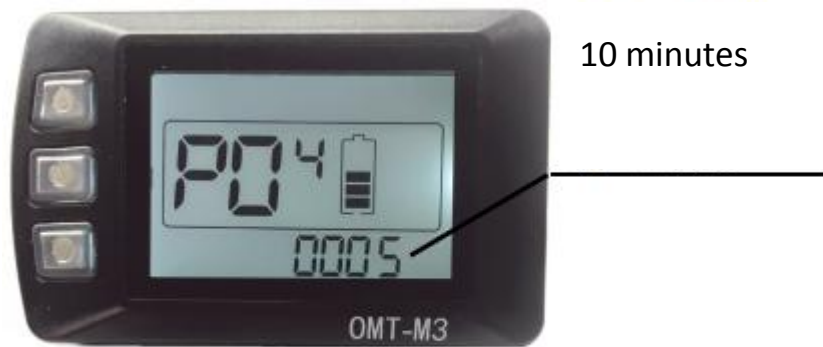

5) P05-Number of Assist levels:

Short press  /  to change level 0->1->2.

0: 3 assist levels



1: 5 assist levels

2: 9 assist levels



P05 = 1

6) P06-Wheel size selection:

short press  /  to switch wheel size, in inch, step: 0.1

inch



26 inch



7) P07-Number of magnets for speed sensor:

short press  /  to switch from 1 to 100.





One magnet for  
Speed sensor

8) P08-speed limit:

short press  /  to set the speed limit from 0 to 100Km/h,  
0 means no limit.



9) P09-Non-zero speed start:

short press  /  to switch from 0 to 1. 0: zero speed start, 1: non-zero speed start.



10) P10-Driving mode selection:

short press  /  to switch from 0->1->2.

- 0: Assist mode (throttle does not work, only assist);
- 1: Electrical driving mode (only throttle works, assist does not work) ;
- 2: Both assist and Electrical driving mode (Not available if in zero speed)

start and electrical driving mode);



11) P11-assist sensitivity setting:

short press  /  to switch from 1 to 24.





12) P12-assist starting power setting:

short press  /  to switch from 0 to 5.







13) P13-Assist magnetic disc types

short press  /  to switch from 5->8->12 , different numbers of magnets.



14) P14-Current limit for the controller:

short press  /  to switch from 1 to 20A

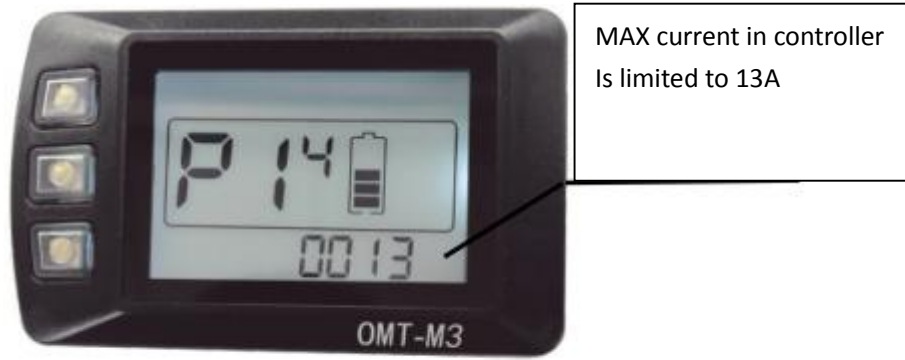

15) P15-low voltage protection for controller

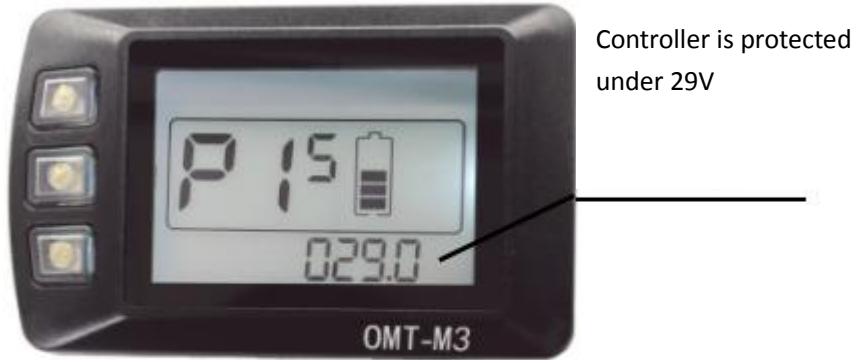

16) P16-Reset ODO distance:

long press  during 5 seconds



Cleared to 0



ODO is 0

17) P18-Reset all parameters:

long press  5 seconds, when it displays "SSSS", all parameters reset to default values(except for the ODO distance)



Ssss means reset to default value

## 7. Specifications

- 1) Power supply: 24V,36V,48V
- 2) Rated current: 10mA
- 3) Max current: 30mA
- 4) Leakage current after power off: <1uA
- 5) Current supply to controller:50mA
- 6) Working Temperature: -18~65°C

7) Storage temperature: -30~80°C

## 8. Error code definition

When an error appears, S900 will notice users by different codes, please refer to table 1 for different codes:

Code (Decimal)	Signification	
0	Normal	
6	Low Battery level	
7	Motor error	
8	Throttle error	
9	Controller error	
10	UART receive error	
11	UART receive error	

Table 1

## 9. Notices

Power on and power off must keep an interval of at least 3 seconds,

please don't press '' button frequently when it is powered off.

When the temperature is under -10°C, the screen will be a little darker than normal, when the temperature increases, the screen can go back to normal